

Smart Toilet Instructions

Model :
CB.10.0026
Installation Manual

Table of contents

Specifications	1
Cautions and Warnings	2
Part List	6
Control Description	9
Installation Instructions	13
Preparation for The First Time Use	14
Battery Installation	15
Packing List.....	16
Maintenance and Cleaning	17
Troubleshooting.....	19

Specifications

Technical Specification

Product Name	Smart Toilet	Warm Water Temp.	4 levels (Room Temperature- 40°C)
Rated Voltage	220-240V	Warm Air Temp.	4 levels (Room Temperature- 60°C)
Rated Frequency	50Hz	Heated Seat Temp.	4 levels (Room Temperature- 40°C)
Rated Power	1100W *	Environment Temp.	5-40°C
Water Efficiency Level	level 2	Warm Water Heating Method	Instant Heating
Dual flush	4.5/3L	Waterproof Level	IPX4
Supply Water Pressure	0.18-0.5MPa	Water entry temperature	1-35°C
Minimum Water Pressure	0.14MPa, and the minimum water flow should be 20 L/Min		
Codes/ Standards	IEC /EN 60335-1 IEC/EN 60335-2-84 AS/NZS60335.2.84		

*Power value testing condition: Water Pressure: 0.2MPa, Inlet Water Temperature: 15°C, Water Flow: 600ml/min.

Max temperature of the water supplied by the product for hygiene: 42°C

There will be no further notice if any technical specification changed due to product improvement and technical update, all real technical specification should be subject to the final product.

CAUTIONS AND WARNINGS

This appliance is not intended for use by persons (including children) with reduced physical, sensory or mental capabilities, or lack of experience and knowledge, unless they have been given supervision or instruction concerning use of the appliance by a person responsible for their safety.

SAVE THESE INSTRUCTIONS



Please read this statement completely and correctly use it.

Please strictly comply with written cautions and warnings.





● Meaning of the Marks:

⊘DON'T: This symbol indicates a prohibited use of the product.



ⓘMUST: This symbol is used to indicate a required step in the use of this product.

 Don' t disassemble	<p>Never disassemble, repair or alter. Do not use tools in places other than designated.</p> <ul style="list-style-type: none"> ● Doing so may cause fire, electrical shock, overheating, short circuit or breakdown.
 Don' t splash water	<p>Do not get any water or cleaning solution on the main unit or connection of power cord.</p> <ul style="list-style-type: none"> ● Doing so may cause fire, electrical shock, heat or short circuit. ● Doing so may cause the product to crack resulting in injury or water damage.
 DON' T	<p>Do not use the product if a malfunction occurs.</p> <ul style="list-style-type: none"> ● In case of breakdown or other problems, be sure to cut off power by flipping the power switch to OFF. Close the water shutoff valve to stop water supply. <p>Possible malfunctions:</p> <ul style="list-style-type: none"> -Water is leaking from a pipe or the main unit. -The product is cracked or broken. -The product makes a strange noise or emits a strange odor. -The product emits smoke. -The product is abnormally hot. -The toilet seat cushion is out of place. - Continued use after malfunction could cause a fire, electric shock, heat, short circuit, injury or water damage. <ul style="list-style-type: none"> ● Continued use after malfunction could cause a fire, electric shock, heat, short circuit, injury or water damage. Please contact to the professionals. ● The recommended service life of smart toilet is 7 years. Please pay attention to the toilet working conditions after 7 years <p>Use tap water only Doing so may cause irritation to the skin and malfunction.</p>



CAUTIONS AND WARNINGS

 STOP	<p>Do not use a loose and unstable power socket. Doing so may cause fire or electrical shock.</p>
	<p>Please insert the power plug into the AC 220-240V to 50Hz and 10A or above socket. Failure to do so may result in fire or electric shock. When the power exceeds the socket specification, it will cause the socket to heat and cause a fire.</p>
	<p>Do not do anything that may damage the power plug. Do not strike, yank, twist, excessively bend, damage, alter, or heat the power cords. Also, do not place anything heavy on, bind or pinch the power cords.</p> <ul style="list-style-type: none"> Using a damaged power cord may result in a fire, electrical shock, heat or short.
 MUST	<p>This is an electrical product. Do not install it anywhere water is likely to get on the product or anywhere with humidity high enough that water is likely to form on the surface of this product. When using the product in a bathroom, install a fan or ventilation port and ensure good air flow through the bathroom.</p> <ul style="list-style-type: none"> Failure to do so may cause fire or electrical shock. <p>If the power cord is damaged, avoid danger by having the manufacturer's repair department or equivalent specialist replace it.</p>
	<p>If the supply cord is damaged, it must be replaced by the manufacturer, its service agent or similarly qualified persons in order to avoid a hazard.</p>
	<p>Children being supervised not to play with the appliance. the appliance is not to be used by persons (including children) with reduced physical, sensory or mental capabilities, or lack of experience and knowledge, unless they have been given supervision or instruction.</p> <p>To prevent from low-temperature burns, please do not sitting on the toilet for a long time.</p>
 Ground wire	<p>This appliance must be earthed. Connect this product to a properly grounded the power supply unit (device) only.</p> <ul style="list-style-type: none"> if not connect well may cause electric shock.
 Must obey	<ul style="list-style-type: none"> Do not raise the toilet seat or lid while objects are resting on top of the unit. Doing so may cause the main unit to come loose and fall, resulting in injury. Do not lean on cover when use this device to prevent product from damage.

CAUTIONS AND WARNINGS

 NO Fire	<p>Keep cigarettes and other open flames away from the product.</p> <ul style="list-style-type: none"> Failure to do so may cause fire.
 Stop	<p>Do not apply strong force, mechanical shock, step on or stand on the toilet seat, toilet lid or main unit. Also do not place any heavy object on the toilet seat, toilet lid or main unit.</p> <ul style="list-style-type: none"> Doing so may cause cracking or cause the main unit to come loose and fall, resulting in injury. Doing so may damage the product and cause injury or water damage.
	<p>Never block the warm air openings of the product by human finger or others. Keep the warm air opening free, otherwise may cause electric shock, personal injury or the damage of product.</p>
 Must obey	<p>Do not fold or crush the water supply hose; do not damage by cutting with a sharp object.</p> <ul style="list-style-type: none"> Doing so may cause water leaks. <p>When maintaining the plastic parts (main unit etc.) or the water supply hose, use a neutral kitchen detergent diluted with water. Do not use any of the following. Toilet cleaner, household cleaner, benzene, paint thinner, powdered cleanser or nylon scrubbing brush.</p> <ul style="list-style-type: none"> These items may damage or crack the plastic and cause injury or malfunction. These items could damage the water supply hose and cause a water leak. <p>To prevent a sudden water leak, do not remove the water filter drain valve when the shutoff valve is open.</p> <ul style="list-style-type: none"> Doing so will cause water to spurt out.
	<p>When installing the water filter drain valve, make sure that it is securely tightened in its proper position.</p> <ul style="list-style-type: none"> Failure to securely tighten it may cause a water leak.
	<p>If a water leak should occur, always close the shutoff valve.</p> <p>When the ambient temperature is likely to drop to 0°C or lower, prevent damage to the pipes and hoses due to freezing.</p> <ul style="list-style-type: none"> Frozen water pipes could cause the main unit and the pipes to break, resulting in a water leak. Regulate the room temperature to prevent the pipes and hoses from freezing during cold months. Drain the water.

CAUTIONS AND WARNINGS

 Must obey	<ul style="list-style-type: none"> Do not expose to direct sunlight. Doing so may cause changes in color or the product malfunction. Do not urinate on the main unit, toilet seat or wand. Doing so may cause a failure or discoloration. Loose the connection of power cord during thunderstorms. When not using the product for a long time, close the shutoff valve, and then turn off the power of the product.
 Must obey	<ul style="list-style-type: none"> The requirement of water pressure should be 0.14MPa-0.5MPa Use a water supply hose which is equipped by the product, old water supply hose can not be used again.
 Must obey	<ul style="list-style-type: none"> During the daily use of the remote control, keep it away from water to prevent water goes inside of the remote control. And please put it back on the holder after every use. When the product is used for a long time, change the batteries of the remote control.

WARNING

- This douche seat must be installed with appropriate backflow protection conforming to the national construction code volume three.
- Installation can only be conducted by the authorized license plumber following NCC Part Three (PCA) with appropriate high-hazard cross connection control.
- Our products internally installed low hazard backflow devices complying with AS/NZS 2845.1. According to NCC Part Three (PCA), WMTS-051: 2020 and AS/NZS 3500.1, our products must be externally installed a high-hazard backflow protection device. We recommended the Reduced Pressure Zone Device (RPZD) to be externally installed, below figure as an example.

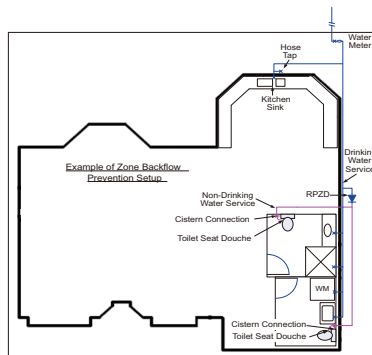

Part List

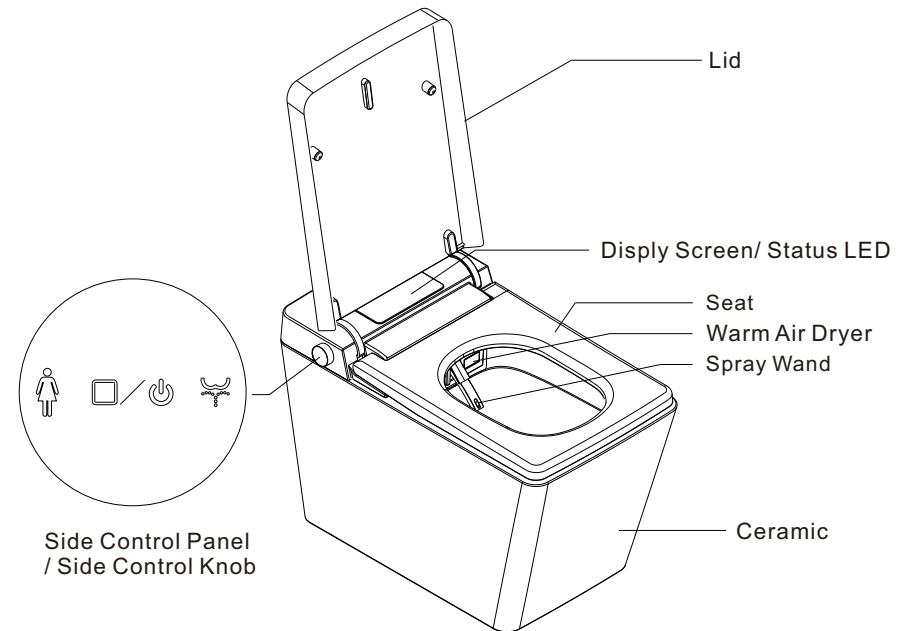

Note: Sketches in above is for reference only, specific appearance shall be subject to the actual object.

Side Control Knob Style:

There are 4 functions of the side control knob: [Dryer/Flush], [Rear Wash], [Lady Wash], [Stop].

When the toilet is not occupied:

Press the knob to flush.

Press and hold the knob for 5 seconds to power on/off the toilet.

When the toilet is occupied:

Turn the knob clockwise to activate spray wand and start rear wash.

Turn the knob anti-clockwise to activate spray wand and start lady wash.

Press and hold the knob for 3 seconds, the toilet will start to activate the dryer followed by flushing.

Side Control Panel Style:

There are 4 functions of the side control knob: [Dryer/Flush], [Rear Wash], [Lady Wash], [Stop].

When the toilet is not occupied:

Press the "Dryer/Flush" icon to flushing.

Press and hold the "Stop" icon for 3 seconds to power on/off the toilet.

When the toilet is occupied:

Press the "Dryer/Flush" icon, the toilet will start to activate the dryer followed by flushing. Press the "Dryer/Flush" icon to stop the Cleansing Features or dryer.

Part List

● Remote Control (shall be subject to the actual object)

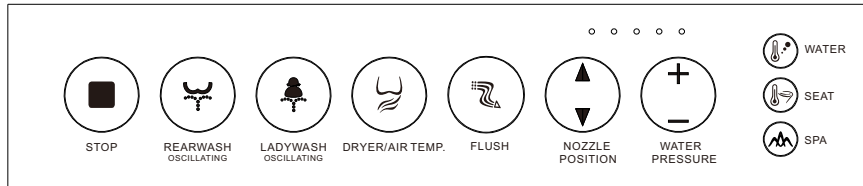

Meanings of the icon on the remote control

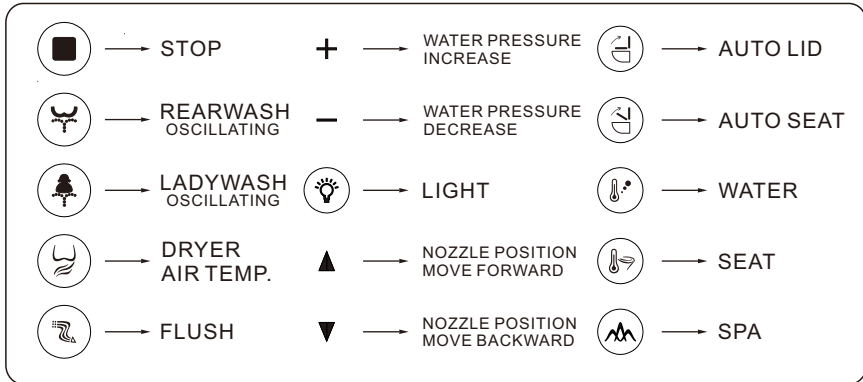

Press and hold "DRYER" for 3seconds each time to adjust warm air temperature from room temperature to different temperature levels, there are 4 gears in total.

Part List

● Remote Control (shall be subject to the actual object)

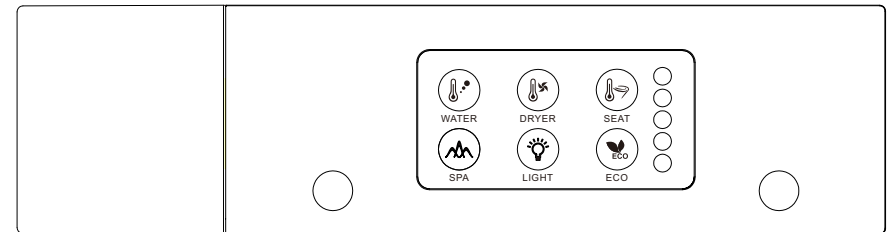
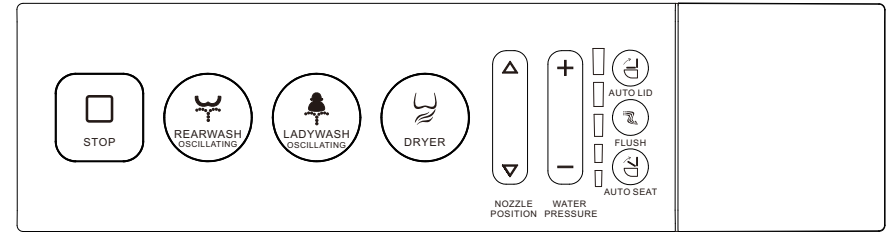

Meanings of the icon on the remote control

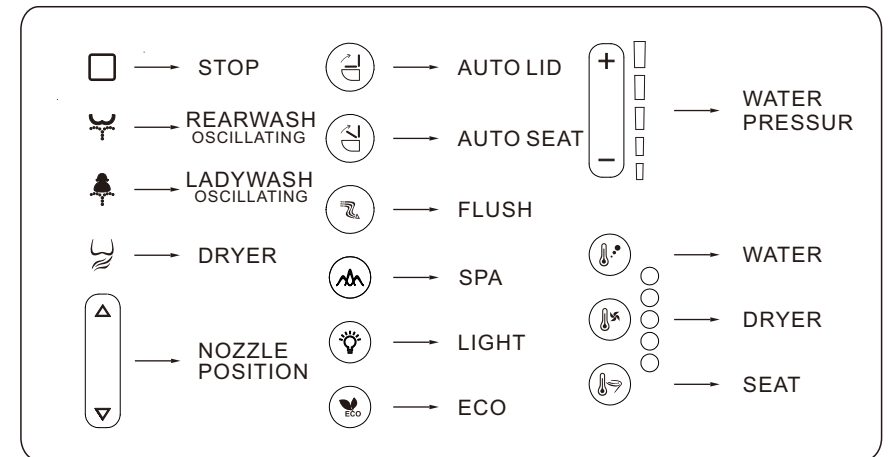

Notes: " " " " is unique to the automatic flip toilet only.

Control Description

Stop

Press " STOP " button to terminate the function of "rear wash"/"lady wash"/"dryer".

Rear Wash/Oscillating

Turn the knob to " REAR WASH " mode, or press " REAR WASH " icon on the remote control, water spray from the rear outlet of the wand will be activated. Press again to enter the state of " OSCILLATING ", which the washing area was expanded and the water moving forward and backward. Washing will stop automatically after 2 minutes.

Lady Wash/Oscillating

Turn the knob to " LADY WASH " mode, or press " LADY WASH " icon on the remote control, water spray from the front outlet of the wand will be activated. Press again to enter the state of " OSCILLATING ", which the washing area was expanded and the water moving forward and backward. Washing will stop automatically after 2mins.

Adjusting Water Pressure

Press the " + " or " - " icon to increase or decrease water pressure.

Adjusting Nozzle Position

Press the " ▲ " or " ▼ " icon to adjust the wand position through 3 settings.

Hot and Cold Water Massage

Press " SPA " icon shortly during cleansing feature to active massage which hot and cold water washing alternately. Press the " STOP " icon to terminate all feature.

Pulsate Massage

Press and hold " SPA " icon for 3 seconds during cleansing feature to active pulsate massage which water pressure changed alternately. Press the " STOP " icon to terminate all feature.

Warm Air Dryer

Warm air dryer should be used after cleansing. Press and hold the knob for 3 seconds or press the " DRYER " icon to activate warm air dryer. This feature will stop automatically after 3 minutes.

Flushing by Remote Control

Press the " FLUSH " icon to manually flush the toilet.

Double press the button quickly to activate small quantity water flush.

Control Description

Automatic Flush After Leave

When enabled (user seated at least 10 seconds), the toilet will automatically flush after the user stands up.

Deodorizer (Optional, Shall Be Subject To The Final Product)

Deodorizer activated automatically after user seats. This feature will stop automatically in 1 minute after user stands up.

Night light

Press the " LIGHT " icon on the remote control to open or close the nightlight.

Water Temperature

Press the " WATER " icon to adjust cleansing water temperature. Press the first time to show current water temperature. Press again to change the water temperature into suitable level.

Warm Air Temperature

Press the " DRYER " icon to adjust the temperature of warm air dryer. Press the first time to show current warm air temperature. Press again to change warm air temperature into the suitable level.

Seat Temperature

Press the " SEAT " icon to adjust cleansing water temperature. Press the first time to show current water temperature. Press again to change the water temperature into suitable level.

- Press " WATER " repeatedly, the corresponding gear will be activated.
Press " DRYER " repeatedly, the corresponding gear will be activated.
Press " SEAT " repeatedly, the corresponding gear will be activated.
- The temperature of warm air will be changed to suitable temperature automatically subjects to the environment temperature.
- After press the icon, a short beep indicates that the feature is enabled, and no beep indicates that the feature is disabled. When the toilet is power-off and restart, all setting above will be saved as the situation before the power-off.

Auto Open/Close Lid

(This feature is unique to the automatic open lid model)

Press the " AUTO LID " icon on the remote control to open/close lid.

Auto Open/Close Seat

(This feature is unique to the automatic open lid model)

Press the " AUTO SEAT " icon on the remote control to open/close seat.

Control Description

Motion-Activated Open/Close Lid (This feature is unique to the automatic flip toilet)

When enabled, the lid automatically open/close when the toilet front motion sensor senses user's motion such as [near], [using] or [leaving].

Auto Flushing by Foot Sensor (Foot Kick) (This feature is unique to the toilet which flushing by foot sensor /foot kick.)

1.Flushing by foot sensor

When enabled, the toilet automatically flushing when the side motion sensor light on the right side of the toilet senses the movement of foot (within 10cm).

2.Flushing by foot kick

When enabled, the toilet automatically flushing when the side kick switch on the right side of the toilet kicked by foot.

Auto Open/Close Lid by Foot Sensor (Foot Kick) (This feature is unique to the automatic open lid model)

The lid automatically opens as the user approaches the product within 1m.
(The original state of the lid should be closed)

1.Auto open/close the lid by foot sensor

When the lid is closed, the cover will automatically open if the side motion sensor light on the right side of the toilet senses the movement of foot. When the seat is closed, the seat will automatically open if the side motion sensor light on the right side of the toilet senses the movement of foot. When the seat is open, the seat will automatically close if the side motion sensor light on the right side of the toilet senses the movement of foot. When the lid is open, the lid will automatically close after the user leave.

2.Auto open/close the lid by foot kick

When the lid is closed, the lid automatically open if the side kick switch on the right side of the toilet kicked by foot. When the seat is closed, the seat automatically open if the side kick switch on the right side of the toilet kicked by foot. When the seat is open, the seat automatically close if the side kick switch on the right side of the toilet kicked by foot. When the lid is open, the lid will automatically close after the user leave.

Control Description

Toilet Bowl Moisture

When the toilet is standby, please do as follow to activate the moisture function.

Side Control Panel Model: To open or close the function of " Toilet Bowl Moisture " , please press and hold the button of " STOP " and " DRYER " at the same time for 3seconds until the beep.

Side Control Knob Model: To open or close the function of " Toilet Bowl Moisture " . Turn and hold the knob to " REAR WASH " side for 3seconds until the beep, then press the " FLUSH " button on the remote control within 2seconds.

Pairing the Remote Control to the Toilet

The remote control cannot be paired to the toilet while the toilet is occupied. For proper operation, follow the steps by different style below to confirm that the remote control and toilet are pairing.

- Side Control Panel Style:Press and hold " REAR WASH " icon on the left side of the toilet for 3 seconds, a short beep indicates that pairing status is activated.
Press any icon on the remote control to finish pairing.
- Side Control knob Style: Turn and hold the control knob to the rear wash side for 3 seconds, a short beep indicates that pairing status is activated. Press any icon on the remote control to finish pairing.

To activate features using the remote control, the remote must be paired with the toilet.

Installation instruction

Preparation before installation

Tools prepared by user: Monkey Spanner, Teflon Tape, Glass Cement Gun, Glass Cement, Tapeline.

Parts included in the package: flange ring, water shutoff valve (Please use the parts included in the package, otherwise may cause product malfunction).

Installation method

1. Install the water supply hose (as the following picture).
2. Install flange on the ceramic base sewage outlet. Then align the ceramic which equipped with flange to the water drain pipe
3. Install the ceramic correctly to the ground, and use glass cement gun to fix. The solidification time of the glass cement is about 24 hours.
4. Install the shutoff valve (Before installing appliances, be sure to completely wash out any dirt, sand, etc. from inside the water supply pipe)
5. Connect water supply hose with the shutoff valve.
6. Leakage protection plug should be well connected on the wall power socket.
7. Please make sure there is no water leakage in any part of the connection. Then open the shutoff valve and the power button to start using this product.

Notes: Please make sure product is installed by the professionals. And carefully check if every part is well installed. Only the water pipes of DN15 approved with valid WaterMark can be used following local plumbing code.

Installation of components

Unit: mm

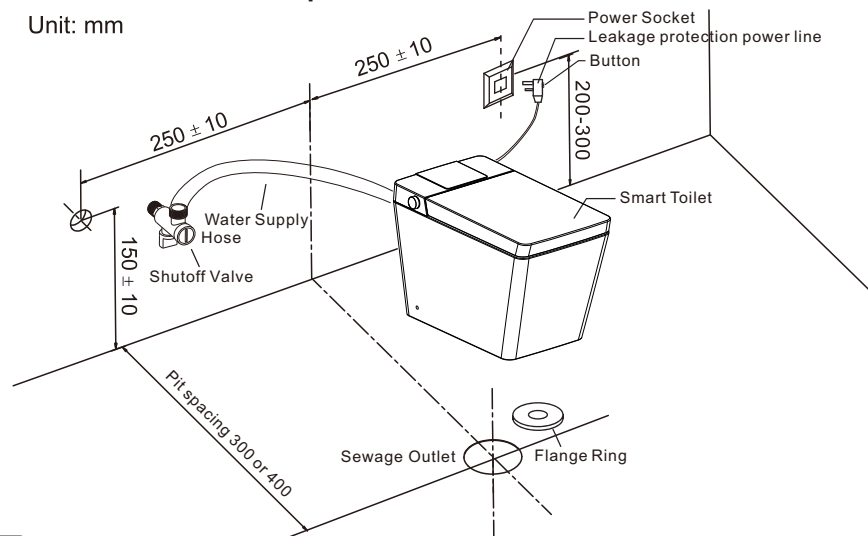

Preparation For the Pirst Time Use

Install the remote control battery

- Step1: Remove the remote control from the hanger
Step2: Open the battery cover and insert two batteries
Step3: Mount the remote control in the hanger, make sure there is no article cover on the remote control.

Notes: Use dry cell, alkaline batteries. Follow the instructions below to prevent the batteries from rupturing or leaking fluid.

- When replacing the batteries, use new batteries of the same brand.
- If you will not be using the remote control for a long time, remove the batteries.
- Do not use rechargeable batteries.
- Resetting the smart toilet after change the batteries.

Turn on the power

Insert the power plug into the socket, and make sure the power indicator lamp on the power plug turns on.

Open the shutoff valve

Fully open the water shutoff valve.

Make sure the indicator lamp lighting

- Make sure the toilet power indicator lamp is on, if not, press the button on the leakage protection plug to turn the power on.
- Make sure the water temperature indicator lamp is on, if not, press the remote control " WATER " button.
- Make sure the seat temperature indicator lamp is on, if not, press the remote control " SEAT " button.

Battery Installation

Battery replacement method (only for external battery box toilet bowl)

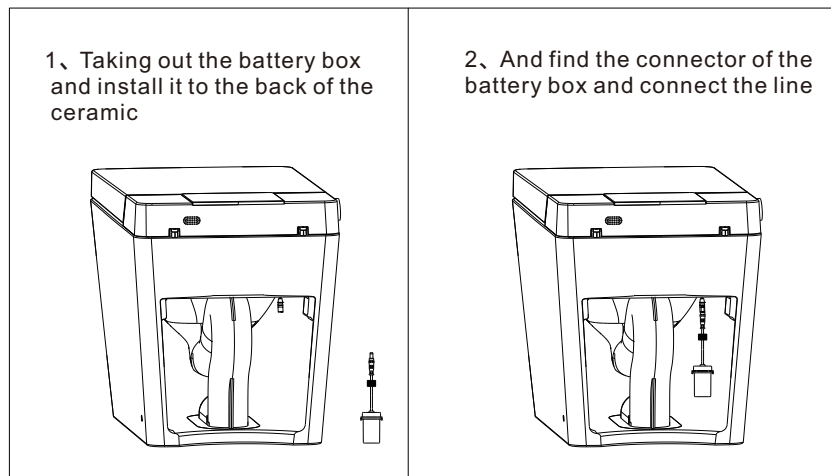

Notes: If the place between the ceramic and wall too small to change the battery after installed, you can choose the convenient place to put the battery box. The battery box is waterproof design.

Note: The draft diagram is only used for refer, and the specific appearance is based on the physical object.

Packing list

If water pressure lower than 0.15MPa, best add a booster pump.

NO.	Name	Quantity	Remark
1	Smart Toilet	1	
2	Water Shutoff Valve	1	
3	Flange Ring	1	
4	Instruction	1	
5	Remote Control	1	including bracket, battery and 3M tape

- There will be no further notice if any change due to product improvement and technical update. The company reserves the right of final interpretation.

Maintenance and Cleaning

To prevent product damage, please do as following:

- Always test your cleaning solution on an inconspicuous area before applying to the entire surface.
- Wipe surfaces clean and rinse completely with water immediately after applying cleaner. Rinse and dry any over spray that lands on nearby surfaces.
- Do not allow cleaners to soak on surfaces.
- Use a soft, dampened sponge or cloth. Never use an abrasive material such as a brush or scouring pad to clean surfaces.

Clean the filter(When the flushing system doesn't function well)

- 1、 Close water shutoff valve to stop the water supply.
- 2、 Remove the filter by coin.
- 3、 Clean the filter:
 - To clean the filter by running water after disassemble it.
 - To remove any residue by toothbrush.
- 4、 Install the filter back:
 - Tightly assemble the filter, and open the water shutoff valve to check if any leakage.
- 5、 Open the water shutoff valve to work.

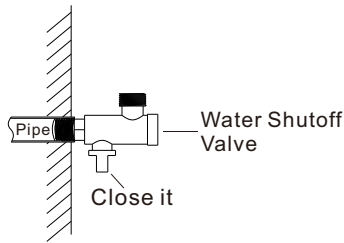

1. Close the water shutoff valve

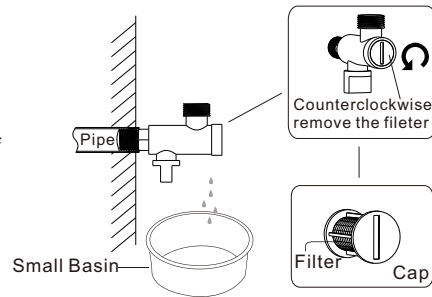

2. Gently remove the filter

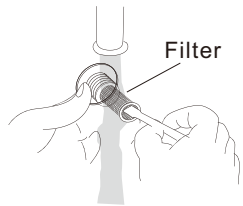

3. Clean the dirty

Maintenance and Cleaning

•Maintenance

1. Nozzle clean

For the Side Control Knob Version:

When the product is standby, turn and hold the side control knob to female wash for 3 seconds until the beeps to activate cleaning wand coming out. Then use a toothbrush to clean the nozzle.

For the Side Control Panel Version:

When the product is standby, press and hold the female wash button for 3 seconds until the beeps to activate cleaning wand coming out. Then use a toothbrush to clean the nozzle.

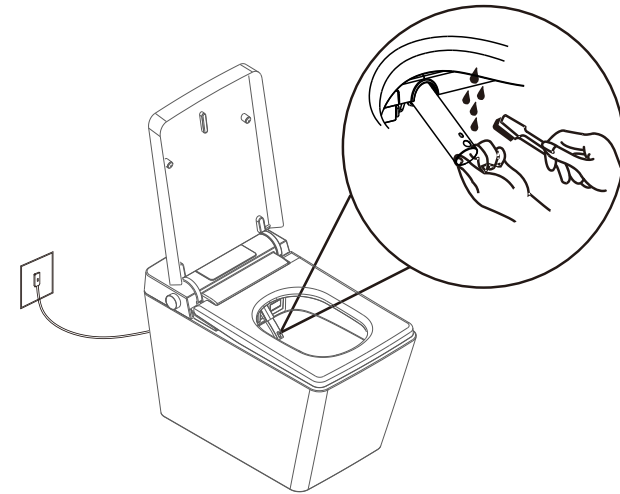

Troubleshooting

Use following way to check the abnormal status, if it still does not work, please call professionals

Symptoms	Probable causes	Recommended Corrective action
Stops in the middle of use	Cleansing features stop automatically after 2 minutes of continuous use.	Restart the clean function after 3 minutes
	seat sensor fails to sense people presence.	Change the position you seat, make sure the sensor is on
Low water temperature	Water heater is off, or the water temperature level is low	Press the "WATER" button to adjust water temperature
Low warm air temperature	Warm air heater is off, or the warm air temperature level is low	Press the "DRYER" button to adjust water temperature
No warm wind suddenly	Dryer features stop automatically after 3 minutes of continuous use.	Restart the dryer function
	Seat sensor fails to sense people presence	Change the position you seat, make sure the sensor is on
Low seat temperature	Seat heater is off, or the heated seat temperature level is low	Press "SEAT" button to adjust seat temperature
Water heating indicator flashes	Unplug the power and resupply, still flashes, cut the power and call professionals	
Seat heating indicator flashes		
All indicators flush	Cut the power and check water supply, wait for water supply and turn on the power	
Toilet leakin	Close the stop valve and check the pipe and call the professionals	

Troubleshooting

Symptoms	Probable causes	Recommended Corrective action
Not work	No power	Please turn on the power
	Plug didn't fit	Plug the toilet in the power socket again
	Failure of electricity supply	Power supply resume and check again
Nozzle has no water come out	The water stop valve does not open	Please open the water stop valve
	Failure of water supply	Please stop wash function, water supply restore check again
	There is foreign articles blocked in the nozzle	Please clean the nozzle and get rid of the foreign articles
	The sensor does not work	Change your seated gesture to make sure sensor is on work
Low water pressure	Set the water pressure on the low level	Reset the water pressure again
	Water supply filter not clean	Clean the filter