

20-Inch Hedge Trimmer

User Manual (LLJ50)

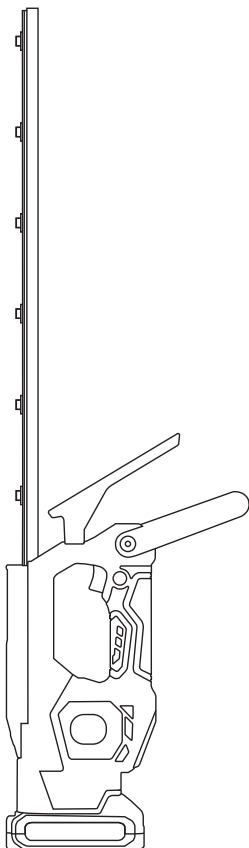

Questions or Concerns?

contact IMOUMLIVE via **support@imoum.com**

Read all safety rules and instructions carefully before operating this tool.

English

| | |
|----------------------------------|----|
| Product Information | 01 |
| Component | 02 |
| Hedge Trimmer Use Safety Warning | 02 |
| Assemble The Hedge Trimmer | 04 |
| Insert The Battery | 05 |
| Charge The Battery | 06 |
| Start to Use | 07 |

Product Information

Specifications

| | |
|----------------|--------------------|
| Model Number | LLJ50 |
| Blade Length | 20 inch |
| Cutting Speed | 2000/2500/3000 min |
| Product Length | 31.2 inch |
| Product Weight | 4.4 Pounds |
| Horsepower | 120W |

Battery Specification

| | |
|------------------|----------------|
| Battery Type | Li-ion Battery |
| Voltage | 21V |
| Battery Capacity | 2.0Ah 37wh |
| Charging Time | 2 Hours |
| Charger Output | 21V 1.2A |
| Working Time | 60 Min |

NOTE

The liquid on the blade is the lubricating oil we added in advance, please don't worry about it and it can be used normally.

Component

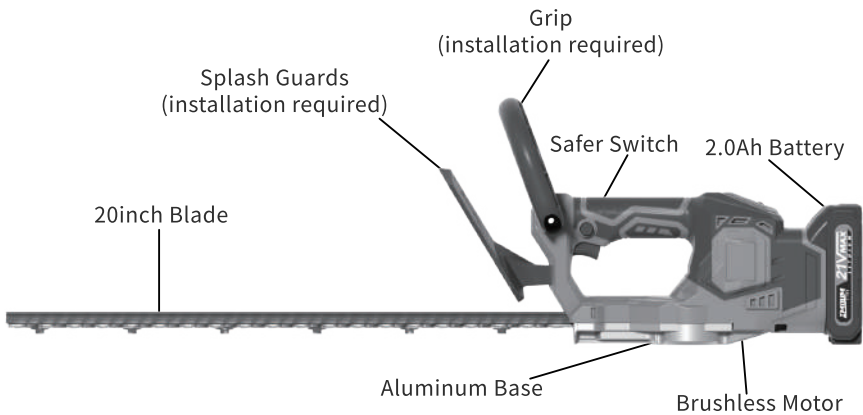

Hedge Trimmer Use Safety Warning

1. Keep all parts of the body at a certain distance from the blade. Do not move away from the cutting material or hold down on the material to be cut while the blade is moving. Make sure the switch is off when clearing jammed material. Distraction during operation of the hedge trimmer could result in serious personal injury.
2. Carry the hedge trimmer by the tool handle with the blade stopped. When transporting or storing the hedge.
3. Carry the hedge trimmer by the tool handle with the blade stopped. When transporting or storing the hedge trimmer, always keep the cutting unit cover on. Proper handling of your hedge will reduce the chance of personal injury from the blades.
4. Because the blade may touch hidden wires, only hold the insulated handle when operating the power tool. When the blade contacts a live wire, the exposed metal part of the power tool may also become live and electrocute the operator.
5. Danger: Hands should be kept away from the blade. Contact with the blade will result in serious personal injury.
6. Do not use the hedge trimmer in rain, water or in a very humid environment. The motor is not waterproof.
7. When the user uses it for the first time, an experienced hedge trimmer user should show him how to use the device.

8. Children or teenagers under the age of 18 are not allowed to use the hedge trimmer. Juveniles over the age of 16 are exempt from this restriction if they have trained under professional supervision.
9. Please only use the hedge trimmer in good physical condition. Fatigue can lead to decreased concentration of the user. This should be especially noted towards the end of the working day. All work should be done calmly and carefully. All losses caused to third parties shall be borne by the user.
10. Never use a hedge trimmer under the influence of alcohol, drugs, or medical treatment.
11. Sturdy leather work gloves are one of the basic equipment when operating a hedge trimmer, and must be worn at all times when operating a hedge trimmer. Also wear sturdy boots with non-slip soles.
12. Before starting work, please check that the trimmer is in good and safe working condition. Make sure the protective cover is in place. Hedge trimmers should not be used until they are fully in place.
13. Make sure your footing is firm before starting to operate.
14. Hold the tool firmly when using it.
15. Do not operate the tool without a load unless necessary.
16. If the blade touches the guide plate or other hard objects, please immediately turn off the motor and remove the battery pack. Check the blade for damage and repair it immediately if damaged.
17. Always turn off the trimmer and remove the battery pack before inspecting the blades, troubleshooting, or removing material stuck on the blades.
18. Switch off the trimmer and remove the battery pack before performing maintenance work.
19. Be sure to remove the battery pack when moving the hedge trimmer to another location (including during work). Never move or carry the trimmer with the blades running. Never grab the blade with your hands.
20. Clean the hedge trimmer (especially the blade) after use and before storing the trimmer for a long time. Apply a small amount of oil to the blade and put the guard on. The stand that comes with the machine can be hung on the wall, providing a safe and practical way to store the hedge trimmer.
21. When storing the machine, cover it and store it in a dry room which is out of the reach of children. Do not store the trimmer outdoors.

22. When using the power supply, do not unplug the AC power cord, which may damage components. Do not place the power supply in a high humidity and/or high temperature environment.

23. There is high voltage inside the power supply. Do not open the power supply enclosure unless you are an authorized service technician or electrician. Unauthorized opening of the case will void the warranty.

24. The power supply should be powered by the power indicated on the nameplate.

25. Failure to observe any warnings or precautions stated in this manual will void all warranties and guarantees.

Assemble The Hedge Trimmer

NOTE

- The liquid on the blade is the lubricating oil we have added, which is convenient for you to use right out of the box.
- Please make sure the handle and splash guard are secured tightly.

1. Install the handle with the included screws.
2. Install the splash guards with an included screw.

Insert The Battery

NOTE

For best results, make sure your battery pack is fully charged.

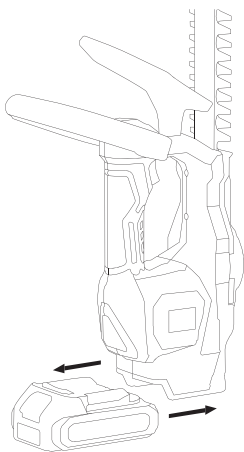

To install the battery pack into the tool handle, align the battery pack with the rails inside the tool's handle and slide it into the handle until the battery pack is firmly seated in the tool and ensure that it does not disengage.

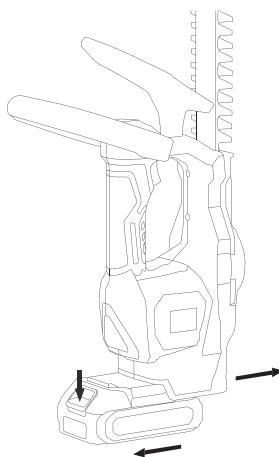

To remove the battery pack from the tool, press the release button and firmly pull the battery pack out of the tool handle.

Charge The Battery

Charge the battery pack with the included adapter by inserting it into the charging jack.

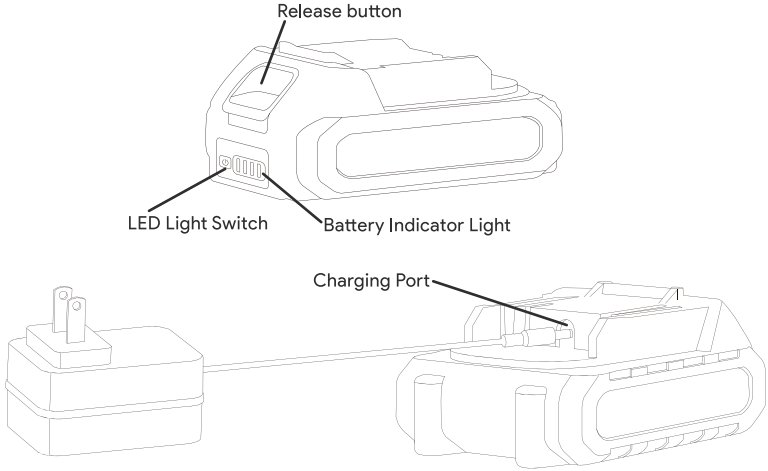

Use our included adapter to charge the battery, and it takes about 2 hours for a single full charge (note: the charging interface is at the position shown in the above figure).

| Indicator Light | Status |
|------------------------|---------------|
| Red | Charging |
| Green | Full Charged |

Start to Use

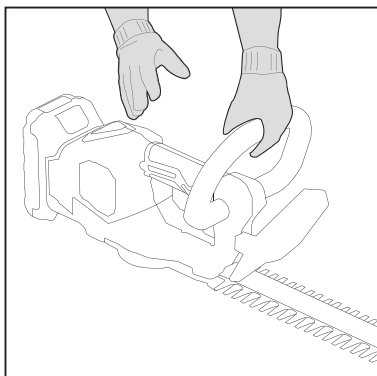

(1) Hold the hedge machine as shown in the picture

| Mode | SPM |
|--------------|-----------|
| Low Speed | 2000/ min |
| Medium Speed | 2500/ min |
| High Speed | 3000/ min |

(2) Start the machine and choosing the appropriate mode

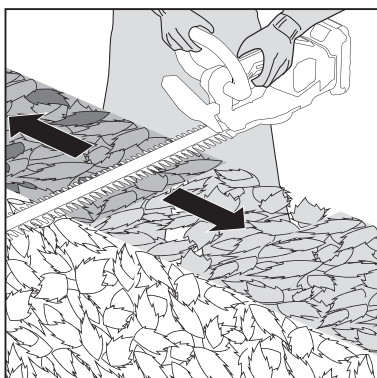

(3) Horizontal left and right cutting.

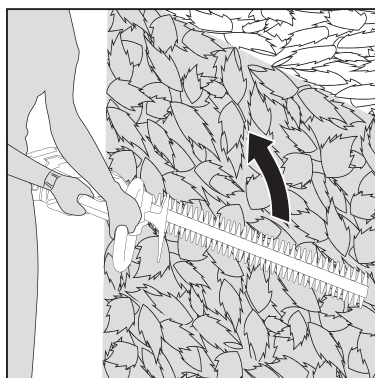

(4) Up and down cutting.

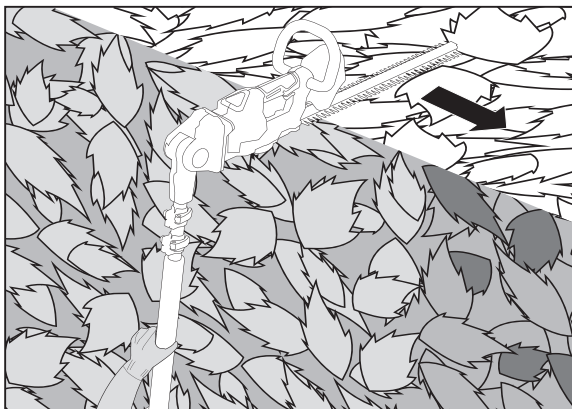

(5) High hedge trimming. Compatible with IMOURLIVE Extension Pole

! NOTE

Compatible extension pole need to bought separately from IMOURLIVE.

IMOUM

L i V E



Brand: IMOUMLIVE

Product name: 20 inch Hedge Trimmer

Model number: LLJ50

WEEE-Reg.-Nr. DE 95546078

Manufacture: Chongqing Mouma Keji You Xian GongSi

Address: 4-1, 131Ha0, Tian Chi Da Dao, Ba Nan Qu,
401320,Chongqing, China

EC REP

EU Responsible Person: C&E Connection

E-Commerce (DE) GmbH

Address: Zum Linnegraben 20, 65933, Frankfurt am
Main, Germany

E-mail: info@ce-connection.de

Contact Us: support@imoum.com



MADE IN CHINA