

CS/ES9700Y SERIES

Operation Manual

Covers the following CS & ES series:

9700Y, 9704Y, 9707Y, 9708Y, 9709Y



GECKO Y SERIES
By **HYDROQUIP™**

Introduction

This manual covers electrical and installation details on the following product series. Some photos and instructions may not apply to the product you have purchased.

-U Series "Fixed" Heater configuration: This series is designed to fit the most common heater position. Depending upon the actual control being replaced, you may still need to modify the plumbing to achieve proper alignment.

-US Series "Slide" Heater configuration: This series is designed to allow the heater to be positioned within 20" of the control to provide an installation with a minimum of plumbing modifications. Depending upon the actual control being replaced, you may still need to modify the plumbing to achieve proper alignment.

-VH Series "Versi-Heat" Heater configuration: This series is designed to allow the heater to be positioned within 60" of the control to provide an installation where there may not be enough room in the immediate equipment area and to minimize plumbing modifications. Depending upon the actual control being replaced, you may still need to modify the plumbing to achieve proper alignment.

-LH Series "Less Heater" configuration: This series allows the use of customer supplied custom heater configurations which may not have been available from Hydro-Quip. Please refer to the "LH" wiring diagram enclosed with the "LH" wiring harness for specific wiring connections and details NOT covered within this manual.

-LF Series "Lo-Flo" heater configuration: This series allows the use of Lo-Flo style heater assemblies.

Table of Contents

Important Safety Instructions.....	3-4
Electrical Installation.....	5-7
GFCI Wiring Detail.....	7
Heater Installation.....	8
Versi-Heat / Optional Heaters.....	8
Power Connection.....	9
Circuit Board Configurations.....	10
Pump Cord Connections.....	10
WiFi Module Installation Kit.....	11
Spaside Control Installation.....	12
K8 Spaside Functions/Features.....	13-15
K8 Power Up & Breaker Settings.....	16
K8 Changing Low-Level Configuration.....	16
K450 Spaside Functions/Features.....	17-19
K450 Power Up & Breaker Settings.....	20
K450 Changing Low-Level Configuration.....	20
Spaside Messages.....	21-22
Operation Considerations.....	23
Trouble Shooting.....	23-24
System Data Label.....	25
Warranty Information.....	25

IMPORTANT SAFETY INSTRUCTIONS

- ! **DANGER** To reduce the risk of injury, do not permit children to use this product unless they are closely supervised at all times.
 - ! **WARNING - RISK OF CHILD DROWNING.** Extreme caution must be exercised to prevent unauthorized access by children. To avoid accidents, ensure that children cannot use a spa or hot tub unless they are supervised at all times.
 - ! **DANGER** To reduce the risk of injury to persons, do not remove suction fittings.
 - ▶ Spa location must accommodate sufficient drainage of water around the base of the structure, as well as the power source compartment.
 - ▶ Prolonged immersion in water that is warmer than normal body temperature can result in a dangerous condition known as HYPERTHERMIA. The causes, symptoms, and effects of hyperthermia may be described as follows: Hyperthermia occurs when the internal temperature of the body reaches a level several degrees above the normal body temperature of 98.6°F. The symptoms of hyperthermia include dizziness, fainting, drowsiness, lethargy, and an increase in the internal temperature of the body. The effects of hyperthermia include (1) unawareness of impending hazard, (2) failure to perceive heat, (3) failure to recognize the need to exit spa, (4) physical inability to exit spa, (5) fetal damage in pregnant women, (6) unconsciousness resulting in danger of drowning. **WARNING** The use of alcohol, drugs or medication can greatly increase the risk of fatal hyperthermia in hot tubs and spas.
 - ! **DANGER - RISK OF ELECTRICAL SHOCK.**

A spa may be installed within 5 feet of metal surfaces if each metal surface is permanently connected by a solid copper conductor attached to the wire connector on the terminal box . Refer to NEC and local codes in effect at the time of installation.)
 - ▶ A bonding lug is provided on the control box to permit connection of a solid copper bonding conductor between this point and any equipment, metal enclosures of electrical equipment, metal water pipe, or conduit within 5 feet (1.5m) of the unit as needed to comply with local requirements.
 - ▶ Bond accessible metal to the dedicated connector on the equipment grounding bus, bond the equipment ground bus to the local common bonding grid as part of the installation in the form of (1) a reinforced concrete slab for support, (2) a ground plate provided beneath the hot tub or spa, or (3) a permanent ground connection that is acceptable to the local inspection authority.
 - ! **DANGER RISK OF ELECTRICAL SHOCK.** Do not permit any electrical appliance, such as a light, telephone, radio, or television, within 5 feet (1.5m) of a spa or hot tub.
- To reduce the risk of injury:**
- ▶ The water in a spa or hot tub should never exceed 104°F (40°C). Water temperatures between 100°F (38°C) and 104°F (40°C) are considered safe for a healthy adult. Lower water temperatures are recommended for extended use (exceeding 10-15 minutes) and for young children.
 - ▶ Excessive water temperatures have a high potential for causing fetal damage during the early months of pregnancy, pregnant or possibly pregnant women should limit spa or hot tub water temperatures to 100°F(38°C).
- Before entering the spa or hot tub, the user should measure the water temperature with an accurate thermometer.
- The use of alcohol, drugs, or medication before or during spa or hot tub use may lead to unconsciousness with the possibility of drowning.
- Persons suffering from obesity or with a medical history of heart disease, low or high blood pressure, circulatory system problems, or diabetes should consult a physician before using a spa or hot tub.

IMPORTANT SAFETY INSTRUCTIONS

Persons using medication should consult a physician before using a spa or hot tub since some medication may affect heart rate, blood pressure, and circulation.

For Cord and Plug Connected Units

Must be connected to a grounded, grounding type receptacle only. NEVER connect the spa to an extension cord.

Do not bury the cord.

For Permanently Installed Units

A terminal marked "G" or "ground" is provided in the wiring box located inside the equipment compartment. To reduce the risk of electric shock, connect the terminal or connector to the grounding terminal of your electrical service or supply panel with a continuous green insulated copper wire in accordance with National Electric Code Table 250-95 and any other local codes in effect at the time of the installation.

For Permanently Installed Units not Provided with an Internal Disconnecting Method

The electrical supply for this product must include a suitably rated switch or circuit breaker to open all ungrounded supply conductors to comply with Section 422-30 of the National Electric Code, ANSI/NFPA 70 1987. The disconnecting means must be readily accessible to the tub occupant but installed at least 5 feet (1.5m) from the tub water.

For Units with Gas Heaters

WARNING - Do not install indoors. This unit uses a gas heater that requires proper ventilation and is intended for outdoor use only.

High Voltage Warning

**HIGH VOLTAGE CAN SERIOUSLY INJURE OR KILL!
ONLY EXPERIENCED TECHNICIANS SHOULD SERVICE THIS
EQUIPMENT.**

DO NOT remove the protective covers from any electrical enclosure, or attempt to service any related electrical device, unless you are a qualified electrician or service professional.

Risk of electric shock. Before working with any electrical connections, make certain that the Main Power breaker from the house breaker box has been turned off.

WARNING

All electrical work must be performed by a qualified electrician and must conform to all local codes.

IMPORTANT

Due to the danger of severe electrical shock, locate all power disconnects before servicing a spa. Precautions must be taken whenever working with breaker boxes, G.F.C.I.'s, or service disconnects.

Electrical Installation

A licensed electrician must accomplish the electrical installation in accordance with the National Electric Code(NEC) Article 680, and any local codes in effect at the time of installation.

Refer to the System Data Label for equipment voltage and maximum amperage draws.

The GFCI (Ground Fault Circuit Interrupter) is a mandatory electrical safety device required for all portable spas and hot tubs as specified in the National Electrical Code Article 680-42. The GFCI in your particular installation may be installed at the electrical service panel or a separate sub-panel.

Use copper conductors ONLY. The ground must be sized following the National Electric Code, Table 250-122. For Power conductor size, refer to the National Electric Code Table 310-16.

A bonding lug has been provided on the control box to allow connection to local ground points. To reduce the risk of electrical shock, a solid copper bonding wire should be connected from this lug to any metal objects within 5 feet of the spa.

The NEC and most local codes require that a “disconnect” be installed within “line-of-site” of the spa.

Circuit & Breaker Rating	15A	20A	30A	40A	50A	60A
Maximum Amps	12A	16A	24A	32A	40A	48A
Minimum Wire Size	14	12	10	8	6	4

The above table is a wiring chart representation.

IMPORTANT- If your electrician is not absolutely sure how to connect your system correctly, call your local dealer. Any mistake may be costly and void your equipment warranty.



CAUTION: Do not connect or disconnect any components while the power is on. All connections must be done with the power off as it may cause damage to the system.



****Any resulting damages are not covered under manufacturer's warranty****



CAUTION: Damage may occur to the circuit board and spaside if the spaside plug is not properly aligned to the receptacle on the circuit board or if the spaside plug is connected or disconnected while the power is on.



****Any resulting damages are not covered under manufacturer's warranty****

Electrical Installation

OPTION 1

GFCI Installed in Main Service Panel

20-60AMP HARDWIRED

MAIN BREAKER PANEL

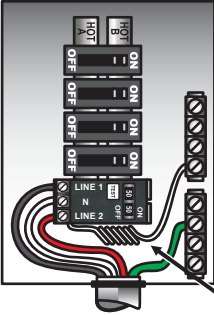

INLINE SPA DISCONNECT

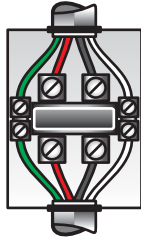

PORTABLE SPA

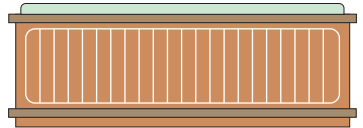

REFER TO GFCI WIRING DETAIL ON PAGE 8

Option 1 shows the power from GFCI breaker installed into main service panel to a service disconnect within line-of-site of the spa. If the manufacturer of your homes main breaker panel makes a GFCI breaker, you may be able to add it to an open slot in the panel.

OPTION 2

Subpanel GFCI Installed

20-60AMP HARDWIRED

MAIN BREAKER PANEL

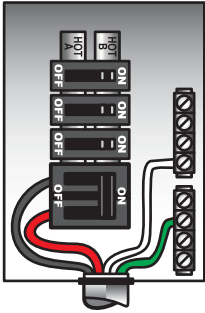

GFCI DISCONNECT

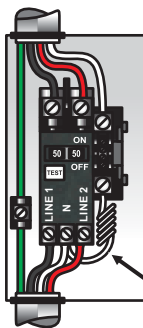

INLINE SPA DISCONNECT



TO PORTABLE SPA



REFER TO GFCI WIRING DETAIL ON PAGE 8

Option 2 shows the power from main service panel to a GFCI subpanel within line-of-site of the spa. (Note: Most local codes will allow a GFCI subpanel to be a disconnect. If this is not the case in your installation, a disconnect must be provided.)

Electrical Installation

If your system was configured to include a 120VAC power cord, ensure that the proper receptacle has been installed (a dedicated circuit is required). DO NOT under any circumstances modify a 20 Amp plug to fit into a 15 Amp receptacle or use an extension cord. Doing so will create hazardous conditions and/or invalidate the warranty.

OPTION 3 Units with 15A / 20A GFCI Plug Connection

15/20AMP CORD END GFCI

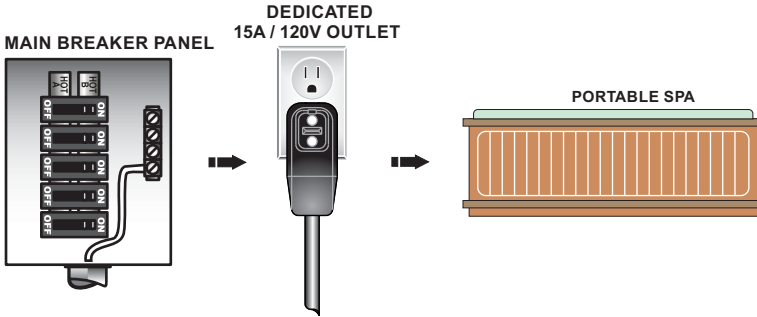

This illustration depicts a typical 15 AMP, cord-end GFCI installation. (The spa must be installed on a dedicated circuit.)

GFCI Wiring Detail

It is important that the GFCI circuit breaker is installed correctly. Often this component has been improperly installed causing the breaker to instantly trip when the system is turned on. Below is an illustration of a typical GFCI breaker installation.

WARNING: Refer to the circuit breaker manufacturers installation instructions. This illustration is meant to be a guide for Field Technicians and is not intended to override or substitute the instructions supplied with the circuit breaker.

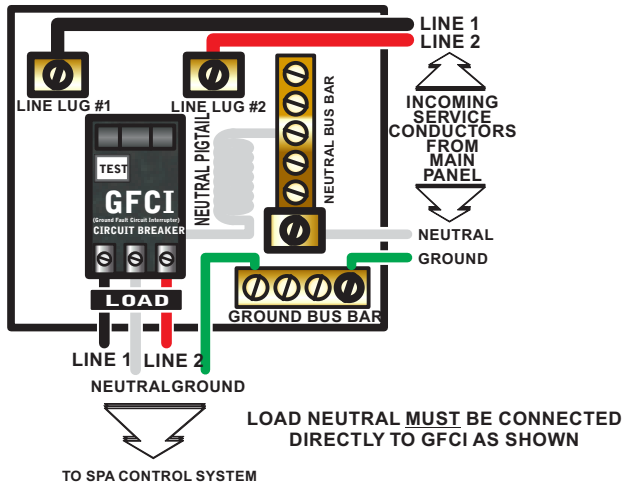

Heater Installation

The "U" Series Fixed Heater and "US" Series Slide Heater systems will arrive from the factory with the heater mounted in the bottom location as pictured in **Step 1**. The "US" Series Slide Heater can be used in this configuration or you can move the Slide Heater to the back of the control as shown below to align easily with your particular plumbing arrangement.

Slide heaters are using the Gecko in.flo technology so it may be installed on either the pressure or vacuum side of the pump.

Step 1



Remove the control system from the carton and verify contents for completeness. If the application is a bottom mount installation then you are ready to go directly to step 6.

Step 3

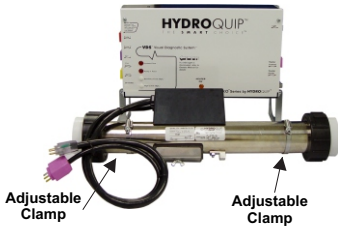

When the adjustable clamps are mounted to the heater, adjust the stud locations to align with the slide brackets on one end. Do not tighten nuts yet.

Step 5

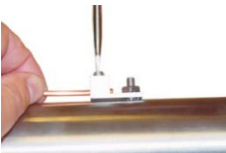

Ground/Bond the heater directly to the control box using #8 solid bonding wire. (not included)

Step 2



If you need to relocate the heater for your installation, simply remove the EZ-Access Heater Retainers and remove the heater from under the box. To utilize the slide brackets, install adjustable stud clamps that are provided in the installation kit to the heater assembly.

Step 4



Align the other studded clamp and attach to the other slide bracket. Now determine the proper alignment for the heater and tighten the nuts and clamps

Step 6



Connect the power control cords from the heater to the matching receptacles on the control box.

Versi-Heat / Optional Heaters

The Versi-Heat series heaters are supplied with a 60" cord which allows for versatile installations and locations. BE SURE HEATER IS INSTALLED HORIZONTALLY.

Versi-Heat heaters are pressure switch controlled. They must be installed on the pressure side of the pump.



IMPORTANT - Heater pump must provide a minimum flow of 18 GPM through the heater.

Power Connection

IMPORTANT: Always refer to the product data label (located on top of the control box) for specific electrical information.

- Use copper conductors only as required by the NEC.
- Secure wires as defined by the NEC and in compliance with any local codes in effect at the time of installation.

240-VOLT ELECTRICAL SERVICE REQUIREMENTS

INPUT VOLTAGE
240V
RED
WHITE
BLACK
GREEN

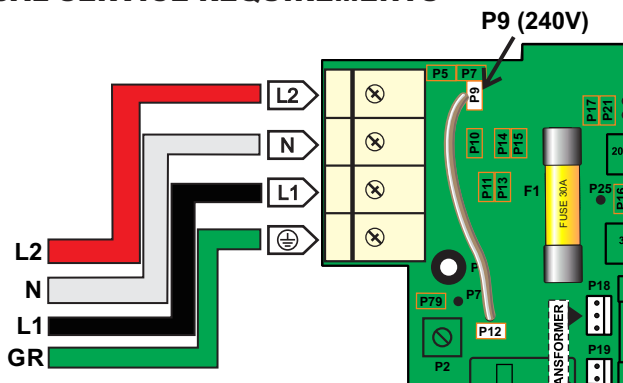

**Heater Voltage (P12) Brown Wire:
Moves to P9 for 240V (Default)**

120-VOLT ELECTRICAL SERVICE REQUIREMENTS

INPUT VOLTAGE
120V

WHITE
BLACK
GREEN

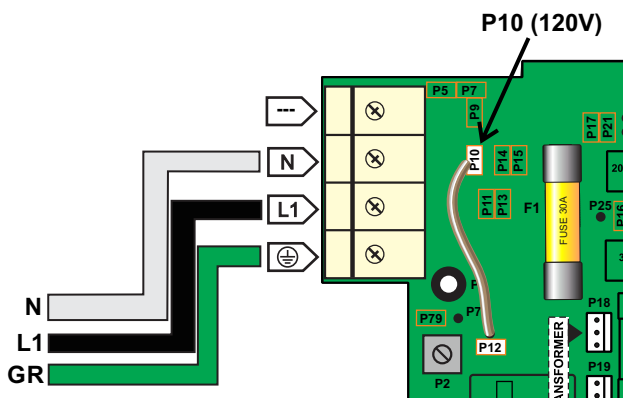

**Heater Voltage* (P12) Brown Wire:
Moves to P10 for 120V**

*Heater wattage is rated at 240V. When running 120V to heater, output is approximately 25%.

IMPORTANT- All equipment must be rated for 120VAC.

Circuit Board Configurations

All component outputs are pre-configured for 120V. If 240V output is required, please utilize the illustration below and the wiring diagram that was included with your unit for the correct component location to properly convert to 240V.

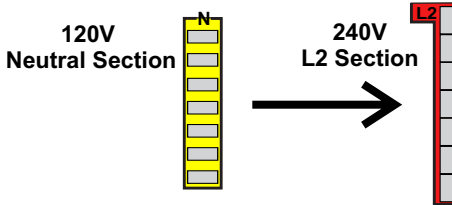
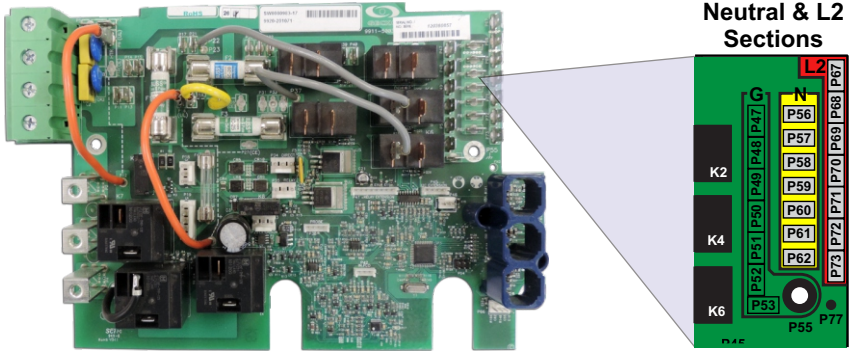

Voltage Selection Chart for 240V Conversion

Component	Volts	Amps	Wire End Color Code	From	To
P1 2-SPD	240V	12A	Red	N	L2
Pump 2	240V	12A	Violet / Blue	N	L2
Pump 3	240V	10A	Violet	N	L2
Blower	240V	8A	Violet	N	L2
Ozone	240V	1A	Yellow	N	L2
Circ Pump	240V	2A	Blue	N	L2

Pump Cord Connections

2-SPEED PUMP CORD CONFIGURATION

The following wiring configuration is for two-speed pump circuits.

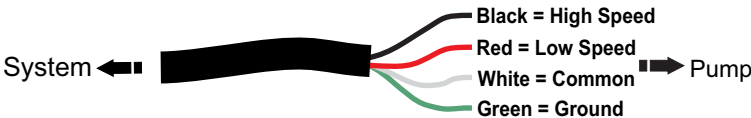

SINGLE SPEED PUMP / ACCESSORY CORD CONFIGURATION

The following wiring configuration is for single-speed pump circuits, circulation pumps, ozones, blowers and accessories.



Wi-Fi Module Installation Kit (Optional)

Your new system has the capability to connect with the internet by using a Wi-Fi Module Kit (sold separately).

If using this option with your system, please make sure to install the module kit following these few steps:

Step 1 - Insert the wi-fi module cable connector (MODULE “CO”) into the empty connection on the system circuit board marked “CO” (Fig.1)

Step 2 - Connect the other module (MODULE “EN”) directly to a wi-fi router utilizing the included network cable and power adapter. (Fig.2)

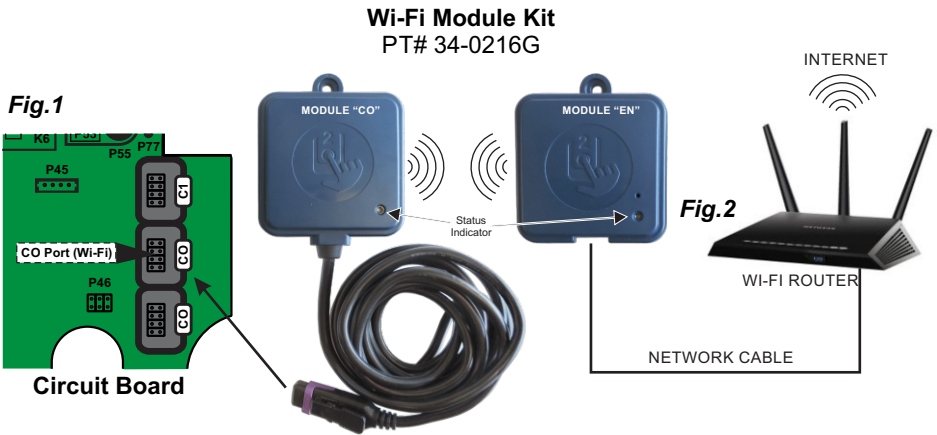

Step 3 - Please follow the detailed instructions provided with the wi-fi module kit to properly install your Gecko (in.Touch 2) App and control the spa.

Note: If you experience poor connection performance it may be necessary to relocate the modules closer together.

Status Light Indicator

Spa Transmitter (CO)

Pairing mode	Yellow (Blinking)
Spa controller not detected	Red
in.touch 2 server detected Module is fully functional	Blue

Home Transmitter (EN)

Pairing mode	Yellow (Blinking)
Router not detected	Red
Router detected	Green
in.touch 2 server detected Module is fully functional	Blue

** When the LED status is blinking (blue, green or red) this indicates communication between the modules has not been established*

Spaside Control Installation

A optional placard has been provided with each control to eliminate problems encountered when the spaside access hole is too large. Use the illustrations and instructions below to install the spaside control provided with your system.

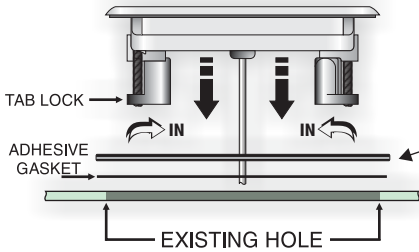

Step 1 - (If control cutout already exists, determine if placard must be used. If existing cutout is sufficient, disregard step 1.) Choose a location for the spaside control. Using the template provided, cut out a 2 5/16" X 6 7/32" hole. Clean area and insert spaside control making sure tab locks are rotated inward. (If placard is required, position and secure using the provided adhesive gasket.)

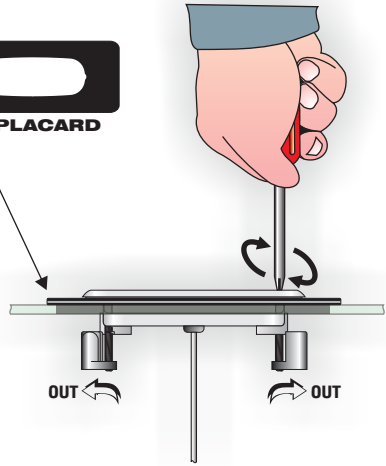

Step 2 - Rotate lock tab screws on face of control clockwise to engage locks and secure control into place.

Step 3 - Remove protective film from display window then clean the face of the spaside. Now carefully align and apply the label. (Fig.3)

Step 4 - Connect spaside to PCB connection marked C1. (Fig.4)



Overlay may vary

Fig. 3

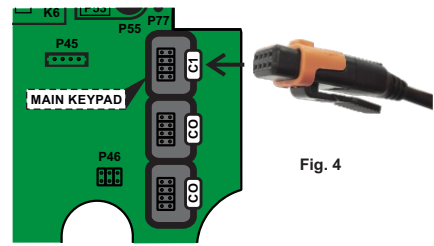
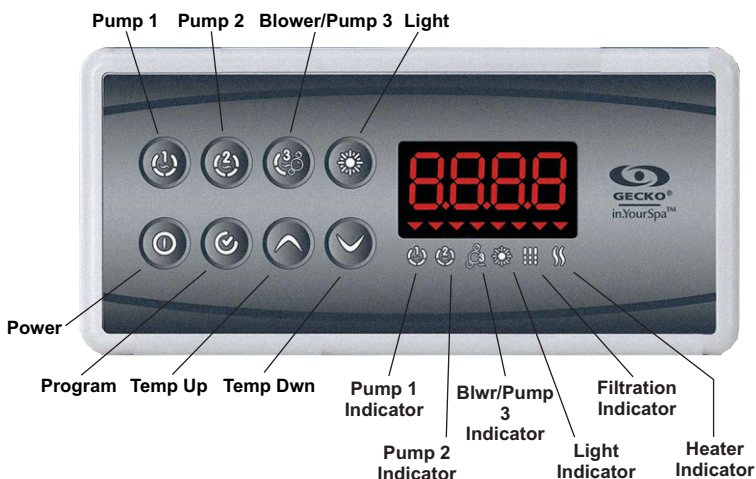





Fig. 4

CS970XY K8 Spaside Functions / Features



 **Pump 1** - Press once to turn on low speed. Press a second time to turn pump to high speed (with a dual-speed pump). A third time turns pump off.

A built-in timer automatically turns the pump off after 20 minutes unless manually deactivated first.

 The "Pump 1" indicator lights up when Pump 1 is on. With dual-speed pump, indicator  will flash when Pump 1 is on at low speed.

 **Pump2** - Press once to turn on pump on, press a second will turn the pump off **unless Two speed pump**. Two speed pump functions as Low, High, Off

A built-in timer automatically turns the accessory off after 20 minutes unless manually deactivated first.

 The "Pump 2" indicator lights up when Pump 2 is on.

***Note: If additional pump(s) are present and they will operate "sequentially" off of the Pump 2 key.**

 **Blower key** - Press Blower key to turn blower on. Press Blower Key again to turn off.

A built-in timer automatically turns the accessory off after 20 minutes unless manually deactivated first.



 The "blower" indicator lights up when Blower is on.

 **Light** - Press once to turn light on. Press Light key a second time to turn light off.



A built-in timer automatically turns the light off after 2 hours unless manually deactivated first.

 The "Light" indicator lights up when light is on.

 **Temp Up** - Use Up key to raise the temperature Set Point. The temperature setting will be displayed for 5 seconds to confirm your new selection.

 The "Set Point" icon indicates that the display shows the desired temperature,  NOT the current water temperature!

 **Temp Down** - Use Up key to lower the temperature Set Point. The temperature setting will be displayed for 5 seconds to confirm your new selection.

 The "Set Point" icon indicates that the display shows the desired temperature,  NOT the current water temperature!

Spaside Functions / Features (Cont.)

① Power Key - This key provides access to:

Manual Economy Mode - When active this mode forces the system to maintain a temperature 20F° less than the set temperature. The display will toggle between "Eco" the clock and the water temperature. Press the power button again to disable economy mode.

Eco = **Economy mode active**

noE = **Economy mode not active**

② FILTER/PROGRAM Key: A quick press of the Filter key will allow you to display the clock. A long press of 5 seconds will allow you to enter the program menu. In the program menu, the following parameters can be set: the clock, the filter cycles or the purge cycles, the economy mode and the temperature units. While you are in the program menu, use the up or down keys to adjust the parameters and use the Filter key jump to the next parameter.

Note: Changes will be saved after the confirmation of the last parameter only. If there is no key press for 10 seconds, the system will exit the program menu without saving the changes.

Images in these pictures may vary from overlay supplied but buttons are in the same location and have the same functionality

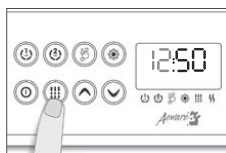

Setting the Clock: Enter the programming menu by pressing and holding the **FILTER** key for 5 seconds. The current time will be displayed with the hours flashing.

Press the **UP** or **DOWN** key to adjust the hours accordingly making sure the **PM** indicator is set properly.



Press the **PROGRAM** key to advance to changing the minutes

Press the **UP** or **DOWN** key to adjust the hours accordingly making sure the **PM** indicator is set properly.

* PM indicator



Setting the Filter Cycle: Enter the programming menu by pressing and holding the **FILTER** key for 5 seconds. The current time will be displayed with the hours flashing. If adjusting the clock is necessary do it now, otherwise press the **FILTER** key repeatedly until **FS##** is displayed. "FS" represents FILTER START "##" represents the start time hour.

*PMindicator

Press the **UP** or **DOWN** key to adjust the hours accordingly making sure the **PM** indicator is set properly.



Press the **FILTER** key until **Fd ##** is displayed. "Fd " represents FILTER DURATION "##" represents the run time for the filter cycle in hours.

0 = No Filtration

24 = Continuous Filtration

Spaside Functions / Features (Cont.)

Images in these pictures may vary from overlay supplied but buttons are in the same location and have the same functionality



Setting the Filter Cycle Frequency: - Enter the programming menu by pressing and holding the **FILTER** key for 5 seconds. The current time will be displayed with the hours flashing. If adjusting the clock is necessary do it now, otherwise press the **FILTER** key repeatedly until **FF##** is displayed. "FF" represents FILTER FREQUENCY
"##" represents the number of cycles per day, **1 - 4** cycles per day.

Press the **UP** or **DOWN** key to adjust the cycles as required.



Setting the Economy Mode: Enter the programming menu by pressing and holding the **FILTER** key for 5 seconds. The current time will be displayed with the hours flashing. If adjusting the clock is necessary do it now, otherwise press the **FILTER** key repeatedly until **EP##** is displayed. "EP" represents ECONOMY PROGRAM
"##" represents cycle enabled or not

1 = On / Cycle Enabled
0 = OFF / Cycle Disabled

Press the **UP** or **DOWN** key to adjust the setting as required.



*PMIndicator

Setting the Economy Start Time: Enter the programming menu by pressing and holding the **FILTER** key for 5 seconds. The current time will be displayed with the hours flashing. If adjusting the clock is necessary do it now, otherwise press the **FILTER** key repeatedly until **E5##** is displayed. "E5" represents ECONOMY START, **"##"** represents hour the cycle starts

Press the **UP** or **DOWN** key to adjust the setting as required paying close PM indicator.



Setting the Economy Duration: Enter the programming menu by pressing and holding the **FILTER** key for 5 seconds. The current time will be displayed with the hours flashing. If adjusting the clock is necessary do it now, otherwise press the **FILTER** key repeatedly until **Ed##** is displayed. "Ed" represents ECONOMY DURATION,
"##" represents the active time in hours.

Press the **UP** or **DOWN** key to adjust the hours as required

0 = No Economy
24 = Continuous Economy

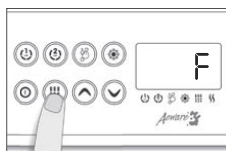

Changing the Temperature Readout: Enter the programming menu by pressing and holding the **FILTER** key for 5 seconds. The current time will be displayed with the hours flashing. If adjusting the clock is necessary do it now, otherwise press the **FILTER** key repeatedly until **F** or **C** is displayed.

Press the **UP** or **DOWN** key to adjust as required

F = Farenheit
C = Celcius

Power Up & Breaker Setting (K8)

Power-up & breaker setting

Boot up display sequence (Each parameter is displayed for 2 seconds)



Lamp test
All the segments and LEDs light up.



Software number
Software Part Number



Software Revision
Revision of the Software



Low-level selection
Low-level selected from Low-level menu

It's important to specify the current rating of the GFCI used to ensure safe and efficient current management (and reduce nuisance GFCI trippings).



It's important to specify the current rating of the GFCI used to ensure safe and efficient current management (and reduce nuisance GFCI trippings).

Press and hold **Filter** button until you access the breaker setting menu.

The values displayed by the system correspond to 0.8 of the maximum amperage capacity of the GFCI

Use **Up / Down** button to select the desired value. The value can be modified typically from 10 to 48 AMP.

Then press **Filter** button to set breaker rating. This table shows typical settings of **b** for different GFCI ratings. Select the one that matches your breaker.

GFCI	b ←
60 Amp	48Amp
50Amp	40Amp
40Amp	32Amp
30Amp	24Amp
20Amp	16Amp

NOTE: If all installed components do not operate or only one component can be operated at a time it may be caused by this setting. Set breaker size accordingly to allow components to run.

Changing System Low-Level Program Configuration

Although every system has been factory set, in certain cases when servicing or replacing a unit in the field, it may be necessary to set a new pre-determined low-level program configuration. Follow these simple steps to re-enter the low-level programming using the spaside control.



Press and hold the **Pump 1** key for 30 seconds

The spaside display will show **L xx** where "xx" represents the previous configuration number registered in the system.

Use the Temp **Up/Down** key to choose the new desired low-level configuration number and press the **Filter** key to confirm the selected configuration (refer to the configuration selection chart below).

If the **Filter** key is not pressed within 25 seconds, the unit will exit this menu without changing any settings.

Low-Level Configuration Number Chart

Model #	Prog #	Pump 1	Pump 2	Pump 3	Blower	Circ Pump
CS970X	17	2 SPD	1 SPD	1 SPD	YES	NO
	18	2 SPD	2 SPD	1 SPD	YES	NO
	19	2 SPD	1 SPD	1 SPD	YES	YES
	20	2 SPD	2 SPD	1 SPD	YES	YES

If at power-up of the system and spaside display shows the following message: , it means that all low-level configurations have been downloaded, but no configuration number has been chosen.

CS970XY K450 Spaside Functions / Features (alternate)

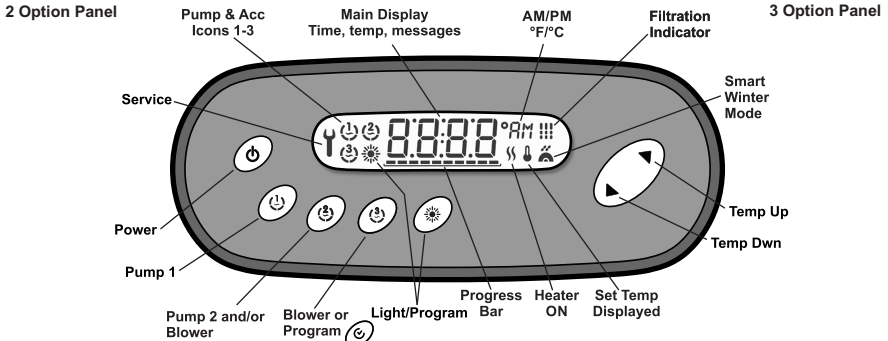

Pump 1 - Press once to activate Low Speed, a second press activates High Speed, a third press turns off the pump.

A built-in timer automatically turns the accessory off after 20 minutes unless manually deactivated first.



The Pump 1 icon lights when Pump 1 is on. It will flash in low speed and be solid when high speed is active.



Pump 2 and/or Blower - Press once to activate Low Speed Pump 2, a second press activates High Speed Pump 2, a third press turns off Pump 2.

Note: When used to activate Pump 2 and Blower (**2 Option Keypad ONLY**) operation is as follows:

Sequential/toggeling operation - Pump 2 Low, Pump 2 High, Blower, Pump 3, etc.

A built-in timer automatically turns the accessory off after 20 minutes unless manually deactivated first.



The accessory #2 icon lights when Pump 2 or Blower is on



Pump 3 or Blower - Press once to activate Pump 3 or Blower

Note: May also activate 4th component if present



The accessory #3 icon lights when Pump 3 or Blower is on



Program Key - Use this key to adjust time, filtration, & economy settings. Press and hold for 5 seconds to enter the programming menu. **Present on 2 Option Keypad ONLY**



Light/Program Key - Use this key to turn the spa light on and off. It may also be used to adjust time, filtration, & economy settings. **use with 3 Option Keypad ONLY**
Press and hold for 5 seconds to enter the programming menu.



The "Light" indicator lights up when the light is on.



Temp Up - Use Up key to raise the temperature Set Point. The temperature setting will be displayed for 5 seconds to confirm your new selection.



The "Set Point" icon indicates that the display shows the desired temperature
NOT the current water temperature!



Temp Down - Use Up key to lower the temperature Set Point. The temperature setting will be displayed for 5 seconds to confirm your new selection.



The "Set Point" icon indicates that the display shows the desired temperature
NOT the current water temperature!

Spaside Functions / Features (Cont.)



Power Key - This key provides access to:

Manual Economy Mode - When active this mode forces the system to maintain a temperature 20F° less than the set temperature, the display will toggle between “Eco” the clock and the water temperature. Press the power button again to disable economy mode.

Eco = Economy mode active

noE = Economy mode not active



OR



Program Key: A long press of 5 seconds will allow you to enter the program menu. In the program menu, the following parameters can be set: the clock, the filter cycles or the purge cycles, the economy mode and the temperature units. While you are in the program menu, use the up or down keys to adjust the parameters and use the **PROGRAM** key jump to the next parameter.

Note: Changes will be saved after the confirmation of the last parameter only. If there is no key press for 10 seconds, the system will exit the program menu without saving the changes.



Setting the Clock: Enter the programming menu by pressing and holding the **PROGRAM** key for 5 seconds. The current time will be displayed with the hours flashing.

Press the **UP** or **DOWN** key to adjust the hours accordingly making sure the **AM/PM** indicator is set properly.

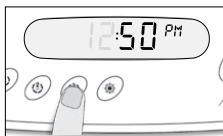

Press the **PROGRAM** key to advance to changing the minutes

Press the **UP** or **DOWN** key to adjust the hours accordingly making sure the **AM/PM** indicator is set properly.

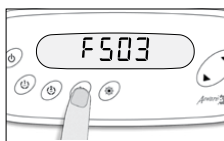

Setting the Filter Cycle: Enter the programming menu by pressing and holding the **PROGRAM** key for 5 seconds. The current time will be displayed with the hours flashing. If adjusting the clock is necessary do it now, otherwise press the **PROGRAM** key repeatedly until F5## is displayed. “F5” represents FILTER START “##” represents the start time hour.

Press the **UP** or **DOWN** key to adjust the hours accordingly making sure the **PM** indicator is set properly.

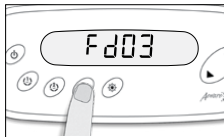

Press the **PROGRAM** key until Fd## is displayed. “Fd” represents FILTER DURATION “##” represents the run time for the filter cycle.

0 = No Filtration

24 = Continuous Filtration

Spaside Functions / Features (Cont.)

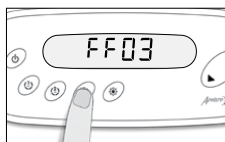

Setting the Filter Cycle Frequency: - Enter the programming menu by pressing and holding the **PROGRAM** key for 5 seconds. The current time will be displayed with the hours flashing. If adjusting the clock is necessary do it now, otherwise press the **PROGRAM** key repeatedly until **FF##** is displayed. "FF" represents FILTER

FREQUENCY "**##**" represents the number of cycles per day, **1 - 4** cycles per day.

Press the **UP** or **DOWN** key to adjust the cycles as required.



Setting the Economy Mode: Enter the programming menu by pressing and holding the **PROGRAM** key for 5 seconds. The current time will be displayed with the hours flashing. If adjusting the clock is necessary do it now, otherwise press the **PROGRAM** key repeatedly until **EP##** is displayed. "EP" represents ECONOMY PROGRAM

"**##**" represents cycle enabled or not

1 = On / Cycle Enabled
0 = OFF / Cycle Disabled

Press the **UP** or **DOWN** key to adjust the setting as required.



Setting the Economy Start Time: Enter the programming menu by pressing and holding the **PROGRAM** key for 5 seconds. The current time will be displayed with the hours flashing. If adjusting the clock is necessary do it now, otherwise press the **PROGRAM** key repeatedly until **ES##** is displayed. "ES" represents ECONOMY START,

"**##**" represents hour the cycle starts

Press the **UP** or **DOWN** key to adjust the setting as required paying close PM indicator.



Setting the Economy Duration: Enter the programming menu by pressing and holding the **PROGRAM** key for 5 seconds. The current time will be displayed with the hours flashing. If adjusting the clock is necessary do it now, otherwise press the **PROGRAM** key repeatedly until **Ed##** is displayed. "Ed" represents ECONOMY DURATION, "**##**" represents the active time in hours.

Press the **UP** or **DOWN** key to adjust the hours as required

0 = No Economy
24 = Continuous Economy

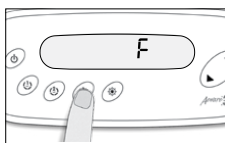

Changing the Temperature Readout: Enter the programming menu by pressing and holding the **PROGRAM** key for 5 seconds. The current time will be displayed with the hours flashing. If adjusting the clock is necessary do it now, otherwise press the **PROGRAM** key repeatedly until **F** or **C** is displayed.

Press the **UP** or **DOWN** key to adjust as required

F = Farenheit
C = Celcius

Power Up & Breaker Setting (K450)

Power-up & breaker setting

Boot up display sequence (Each parameter is displayed for 2 seconds) **Numbers may vary**



Lamp test
All the segments and LEDs light up.



Software number
Software Part Number



Software Revision
Revision of the Software



Low-level selection
Low-level selected from Low-level menu

It's important to specify the current rating of the GFCI used to ensure safe and efficient current management (and reduce nuisance GFCI trippings).



It's important to specify the current rating of the GFCI used to ensure safe and efficient current management (and reduce nuisance GFCI trippings).

Press and hold **Program** button until you access the breaker setting menu.

The values displayed by the system correspond to 0.8 of the maximum amperage capacity of the GFCI

Use **Up / Down** button to select the desired value. The value can be modified typically from 10 to 48 AMP.

Then press the **Program** button to set the breaker rating. This table shows typical settings of **b** for the different GFCI ratings. Select the one that matches the supply breaker

GFCI	b ←
60 Amp	48Amp
50Amp	40Amp
40 Amp	32Amp
30Amp	24Amp
20Amp	16Amp

NOTE: If all installed components do not operate or only one component can be operated at a time it may be caused by this setting. Set breaker size accordingly to allow components to run.

Changing System Low-Level Program Configuration

Although every system has been factory set, in certain cases when servicing or replacing a unit in the field, it may be necessary to set a new pre-determined low-level program configuration. Follow these simple steps to re-enter the low-level programming using the spaside control.



Press and hold the **Pump 1** key for 30 seconds

Note: DO NOT let off the button until 30 seconds has passed and L# is displayed. You will see other values displayed prior that are to be ignored during this programming process.

The spaside display will show **L xx** where "xx" represents the previous configuration number registered in the system.

Use the Temp **Up/Down** key to choose the new desired low-level configuration number and press the **Light** key to confirm the selected configuration (refer to the configuration selection chart below).

If the **Filter** key is not pressed within 25 seconds, the unit will exit this menu without changing any settings.

Low-Level Configuration Number Chart

Model #	Prog #	Pump 1	Pump 2	Pump 3	Blower	Circ Pump
CS970X	17	2 SPD	1 SPD	1 SPD	YES	NO
	18	2 SPD	2 SPD	1 SPD	YES	NO
	19	2 SPD	1 SPD	1 SPD	YES	YES
	20	2 SPD	2 SPD	1 SPD	YES	YES

If at power-up of the system and spaside display shows the following message: , it means that all low-level configurations have been downloaded, but no configuration number has been chosen.

Smart Winter Mode

Our Smart Winter Mode protects your system from the cold by turning pumps on several times a day to prevent water from freezing in pipes. When the system detects a risk of freezing, the Smart Winter Mode protection kicks in and remains active till a full 24 hours has passed without the risk of freezing.



Smart Winter Mode
Active Indicator

Spaside Messages



An internal hardware error has been detected in the spack



Temperature sensor malfunction

This error will occur when a problem with the temperature sensor exists. Contact your local spa dealer



Water has exceeded 108F at the temperature sensor.

The heater, pump and accessory will be deactivated until the water cools. Be sure to check the actual water temperature with an accurate thermometer.

DO NOT ENTER SPA WATER!!



The spa water has exceeded 119F at the high-limit sensor.

The heater will deactivate while the pump and accessory will still operate. The blower (if equipped) can be activated to help cool the water. Water must be below 119F and power must be reset to clear the "HL" error

DO NOT ENTER SPA WATER!!

1. A dirty spa filter can also cause a restricted flow of water, be sure the filter is cleaned regularly and ensure all water shutoff valves are open.
2. If the system has been operating normally until now, the pump may be overheating the spa. Refer to "Programing Filtration" on page 18 and reduce the duration and/or number of cycles per day.
3. If you've eliminated items 1 & 2 as problems, the high-limit sensor may have malfunctioned.

Contact your local spa dealer



The system did not detect any water flow while the heater pump was running.

Make sure that the low-level programming has been properly set, with or without circulation pump (depending on your system configuration)

Make sure water valves are open and proper water level

Check and remove anything obstructing the filter

Spaside Messages Cont'd



The system detected water flow when the heater main pump was or is off.

Make sure that the low-level programming has been properly set, with or without circulation pump (depending on your system configuration)

If present while heater pump is off pressure/flow switch may be stuck shut or need replacement and/or adjustment.



No low-level configuration software has been downloaded into the system.



Temperature inside the spa skirt is too high, causing the internal temperature in the spa pack to go above normal limits.

System Plug Pinouts

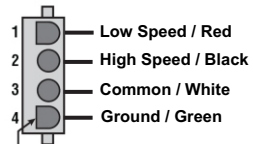
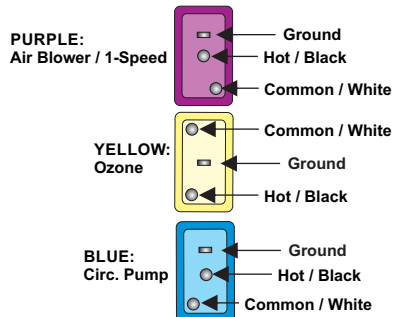
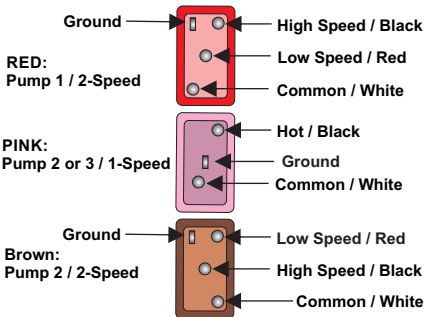

Note flat sides in connector

Operation Considerations

The following describes situations you may encounter and situations to be aware of.

Warm Weather Conditions

Since your spa will normally be expected to maintain warm to hot water ready for use, a great deal of attention has been directed to the energy conservation detail of insulation to keep electrical cost down. Energy conservation efficiency may be achieved by extensive insulation of the spa cabinet, plumbing, spa shell and in some climates full foam insulation may have been provided. This energy conservation feature may cause an inconvenience during warmer times of the year. During warm periods of the year, the temperature within the equipment compartment can elevate to a point that the pump will automatically turn off for a short amount of time (15-30 minutes) to allow the pump to cool down before automatically restarting. This cool down feature will not harm your spa, but serves only to protect the pump from damage and as an indicator that it is too hot. To minimize this occurrence, refrain from using your Hydrotherapy Jets for prolonged periods of time during warm seasons. The jet pump chosen for your spa has been specifically sized for maximum performance and your Hydrotherapy enjoyment.

Filtration System

Please refer to your Spa Manufacturer's Owner's Manual regarding the operation, maintenance and cleaning of your filtration system.

IMPORTANT - Heater pump must provide a minimum flow of 23 GPM through heater.

Winterizing

When freezing weather and/or power losses are expected, contact your local spa dealer for freeze protection or winterizing recommendations for both the spa and the equipment system. Freeze related damage is not covered by the warranty.

Chemical Water Treatment

Your dealer is familiar with local water conditions and which chemicals are compatible with and designed specifically for your spa. This is the best person to advise you on proper water quality management. The one thing you can do to insure years of trouble free equipment operations is to maintain proper water chemistry.

Two basic goals of the chemical water treatment are sanitizing and balancing the water. Sanitizing simply means keeping the water free from microorganisms including algae, bacteria and viruses. The current most popular chemicals for sanitizing include chlorine, bromine and ozone.

Balancing water means establishing a balance among pH, total alkalinity and total hardness. Water that is unbalanced can corrode the spa and it's support equipment or leave deposits of minerals. Properly balanced water is essential to allow the sanitizing chemical to work effectively. There are numerous chemical additives to help you in controlling pH, total hardness and alkalinity. Never use softened water when filling you spa. Softened water is extremely corrosive to the metal parts of the spa equipment and may lead to an unforeseen failure. Sometimes, despite your most diligent efforts, your water may become to far out of balance to be managed chemically. At this point it is probably better to drain and clean the spa and start over with fresh water. Equipment failure caused by improper water chemistry will not be covered under warranty. Saltwater purification systems can potentially damage your equipment. Any related failures will not be covered under warranty.

Troubleshooting

Therapy Jet Not Operational

- Water Shut-Off Valves are Closed - *Open Shut-Off valves.*
- Dirty Filter - *Clean or replace filter.*
- Jets Not Properly Adjusted - *Adjust Jets properly.*
- Diverter Valve Not Properly Adjusted - *Adjust diverter valve properly.*
- Thermal Overload Tripping - *Check for restricted flow of water.*

Water Leaks

- Spa Overfilled - *Adjust water level.*
- Too Many People in the Spa - *Adjust water level.*
- Drain-Valve Left Open - *Close drain valve.*
- Couplings or Unions Loose - *Tighten or contact your local dealer.*
- Pump Seal Leaking - *Contact your local dealer.*
- Plumbing / Connections Leaking - *Contact your local dealer.*
- Water Leaking from Spaside Control - *Contact your local dealer.*
- Water in Air Blower Plumbing - *Contact your local dealer.*

No Heat

- Temperature Not Set Correctly - *Adjust Set Point.*
- Over or High Temperature Protection On - *Refer to Spa Side Messages*
- Current Limiting On - *120V Systems will not heat if High Speed or Blower is on. Contact your local dealer.*
- No Power - *Reset breaker at service panel.*
- Low Water Flow - *Clean or Replace filter.*
- System is in Rest Mode - *Refer to Modes on page 19.*

Light Not Operation

- Light Bulb Defective - *Replace bulb or contact your local dealer.*
- Reflector has Fallen Off - *Replace deflector or contact your local dealer.*
- Light Not Plugged-In - *Plug in the Light.*

High Heat

- Filter Cycles Running Too Long - *Adjust filter cycles down.*
- Temperature Set Too High - *Adjust Set Point.*
- High Ambient Temperature - *Remove spa cover.*

GFCI Breaker Trips Occasionally

- Lightning / Electrical Storm or Power Surge - *Reset GFCI Breaker.*
- NOTE: The GFCI breaker must be properly installed by a licensed electrician.

GFCI Breaker Trips Immediately

- Defective Component or Improper GFCI Breaker Installation - *Contact a qualified service technician or the factory for assistance.*
- Temp/Hi-Limit sensor not connected - *Connect Temp/Hi-Limit to P38 on PCB*

Troubleshooting

The following describes situations and possible solutions to common problems you may encounter as a spa owner.

TroubleShooting

Nothing Operates

- Main Breaker is OFF - *Set to On.*
- Sub-Panel Breaker Off - *Set to On.*
- Equipment GFCI Off - *Set to On.*
- Power switch in Off position - *Set to On.*
- Components not plugged in - *Plug in components.*
- Power cord not plugged in - *Plug in power cord.*
- Over or High Temperature Protection On - *Refer to Spa Side Messages.*

No, Low or Surging Water Flow

- Air Lock in Plumbing System - *“Bleed” the system.*
- Restricted Flow - *Insure that the water shut-off valves are open and that suction fittings are not blocked by debris.*
- Dirty Filter - *Clean or replace filter.*
- Low Water Level - *Increase water level to recommended level.*

Low Speed Pump Not Operational

- Circuit board configuration is Incorrect - *Contact your local dealer.*
- Pump Not Plugged-In - *Plug in the Pump.*
- Blown Fuse - *Contact your local dealer.*

Jets or Blower Not Operational

- Blower or Pump Not Plugged-In - *Plug in the Blower or Pump.*
- Blown Fuse - *Contact your local dealer.*
- Over or High Temperature Protection On - *Refer to Spa Side Messages.*

System Data Label

Note: This information will be necessary if you should ever have to request warranty or any other type of service.

The system data label is located on the control box. This label is very important and contains information you will need to establish your electrical service. The voltage and amperage ratings are shown on the bottom of the label. Product, Model, Serial and Code numbers are also shown on the label.

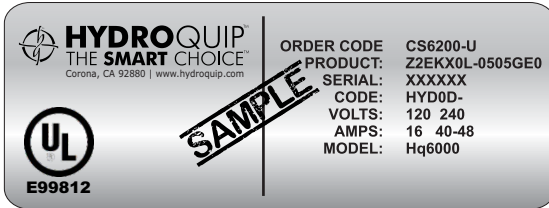

Warranty Information

Hydro-Quip warrants its products to the original purchaser to be free from defects in material and workmanship for a period of 1 year (12 months) from the original date of purchase, except as noted below.

Products which become defective within the warranty period will be repaired or replaced (at the option of Hydro-Quip) except for damage due to freezing, water chemistry, negligence, abuse, misuse, misapplication, unauthorized modification, improper installation, normal wear and tear or chemical attack.

This warranty extends only to normal, personal (non-commercial) usage by the original purchaser. Pump seals, o-rings, gaskets, air blower brushes are only covered for 90 days from original date of purchase.

Hydro-Quip will not be responsible for labor incurred in removing, inspecting or reinstalling of warrantable products. Hydro-Quip will not be responsible for any travel related charges or labor costs attributable to disassembly and reassembly of the spa, skirt, decking or any other materials enclosing the product, or attributable to difficulties in gaining access to the product.

Hydro-Quip will not be responsible for labor incurred for routine maintenance, adjustments or alterations to the calibration of electrical devices.

Any products which are claimed to be defective must be shipped freight prepaid to Hydro-Quip and the repaired or replaced product will be returned to the sender freight collect. When sent to Hydro-Quip, the product must be accompanied by the sales receipt or other proof of the purchase date as well as the sender's name, mailing address, daytime phone number and a detailed description of the defect as well as any other information relating to this claim.

Unless state law expressly provides otherwise, Hydro-Quip will only be responsible for repair or replacement of any of its products that are found to be defective as provided above, and will not bear the cost of any consequential damages. This warranty gives you specific legal rights but you may have other rights which vary from state to state.



HYDROQUIP™

THE **SMART** CHOICE™

510A N. Sheridan St - Corona, CA 92878

PH: 951-273-7575 - Fax: 951-273-7550

www.hydroquip.com