

HYDROQUIP™

UNIVERSAL AIR SERIES

SYSTEM OPERATION MANUAL

THE **SMART** CHOICE™

CONTENTS

Important Safety Instructions	2
INTRODUCTION	
Major Component Illustration	4
SYSTEM OPERATION	
Illustration	5
System Mis-Wire	6
System Over Temperature	6
System Timer (Setting Filtration)	7
Mode Selection	8
Thermostat Setting	8
Heater "On" Indicator	9
Heater Operation	9
Spaside Control	9
Spa Light	10
Jet Pump	10
Auxiliary Pump (Optional)	10
Air Blower	10
OPERATIONAL CONSIDERATIONS	
Warm Weather Conditions	11
Spaside Control Buttons	11
High Water Temperature	11
Filtration	12
Chemical Water Treatment	12
Freeze Protection	12
TROUBLESHOOTING	13
Warranty Information	16
Notes	17

IMPORTANT SAFETY INSTRUCTIONS

READ AND FOLLOW ALL INSTRUCTIONS

- ❗ **DANGER** To reduce the risk of injury, do not permit children to use this product unless they are closely supervised at all times.
- ❗ **WARNING - RISK OF CHILD DROWNING.** Extreme caution must be exercised to prevent unauthorized access by children. To avoid accidents, ensure that children cannot use a spa or hot tub unless they are supervised at all times.
- ❗ **DANGER** To reduce the risk of injury to persons, do not remove suction fittings.
- ▶ Spa location must accommodate sufficient drainage of water around the base of the structure, as well as the power source compartment.
- ▶ Prolonged immersion in water that is warmer than normal body temperature can result in a dangerous condition known as **HYPERTHERMIA**. The causes, symptoms, and effects of hyperthermia may be described as follows: Hyperthermia occurs when the internal temperature of the body reaches a level several degrees above the normal body temperature of 98.6°F. The symptoms of hyperthermia include dizziness, fainting, drowsiness, lethargy, and an increase in the internal temperature of the body. The effects of hyperthermia include (1) unawareness of impending hazard, (2) failure to perceive heat, (3) failure to recognize the need to exit spa, (4) physical inability to exit spa, (5) fetal damage in pregnant women, (6) unconsciousness resulting in danger of drowning. **WARNING** The use of alcohol, drugs or medication can greatly increase the risk of fatal hyperthermia in hot tubs and spas.
- ❗ **DANGER - RISK OF ELECTRICAL SHOCK.** Install at least 5 feet (1.5m) from all metal surfaces. (A spa may be installed within 5 feet of metal surfaces if each metal surface is permanently connected by a solid copper conductor attached to the wire connector on the terminal box that is provided for this purpose. Refer to NEC and local codes in effect at the time of installation.)
- ▶ A pressure wire connector is provided on the control box to permit connection of a solid copper bonding conductor between this point and any equipment, metal enclosures of electrical equipment, metal water pipe, or conduit within 5 feet (1.5m) of the unit as needed to comply with local requirements.
- ▶ Bond accessible metal to the dedicated connector on the equipment grounding bus, bond the equipment ground bus to the local common bonding grid as part of the installation in the form of (1) a reinforced concrete slab for support, (2) a ground plate provided beneath the hot tub or spa, or (3) a permanent ground connection that is acceptable to the local inspection authority.
- ❗ **DANGER RISK OF ELECTRICAL SHOCK.** Do not permit any electrical appliance, such as a light, telephone, radio, or television, within 5 feet (1.5m) of a spa or hot tub.
- ▶ **To reduce the risk of injury:**

The water in a spa or hot tub should never exceed 104°F (40°C). Water temperatures between 100°F (38°C) and 104°F (40°C) are considered safe for a healthy adult. Lower water temperatures are recommended for extended use (exceeding 10-15 minutes) and for young children.
- ▶ Excessive water temperatures have a high potential for causing fetal damage during the early months of pregnancy, pregnant or possibly pregnant women should limit spa or hot tub water temperatures to 100°F(38°C).

Before entering the spa or hot tub, the user should measure the water temperature with an accurate thermometer.

The use of alcohol, drugs, or medication before or during spa or hot tub use may lead to unconsciousness with the possibility of drowning.

Persons suffering from obesity or with a medical history of heart disease, low or high blood pressure, circulatory system problems, or diabetes should consult a physician before using a spa or hot tub.

Persons using medication should consult a physician before using a spa or hot tub since some medication may affect heart rate, blood pressure, and circulation.

For Units with a GFCI (Ground Fault Circuit Interrupter)

This appliance is provided with a ground-fault-circuit-interrupter located on the control box. Before each use and with the unit operating, push the test button. The unit should stop operating and the reset button should appear. Push the reset button. The unit should now operate normally. If the interrupter does not perform in this manner, a ground current is flowing indicating the possibility of electrical shock. Disconnect the power, or unplug from receptacle, until the fault has been identified and corrected.

For Cord and Plug Connected Units

Connected to a grounded, grounding type receptacle only. NEVER connect the spa to an extension cord.

Do not bury the cord.

WARNING To reduce the risk of electrical shock, replace damaged cord immediately.

For Permanently Installed Units

A terminal marked "G" or "ground" is provided in the wiring box located inside the equipment compartment. To reduce the risk of electric shock, connect the terminal or connector to the grounding terminal of your electrical service or supply panel with a continuous green insulated copper wire in accordance with National Electric Code Table 250-95 and any other local codes in effect at the time of the installation.

For Permanently Installed Units not Provided with an Internal Disconnecting Method

The electrical supply for this product must include a suitably rated switch or circuit breaker to open all ungrounded supply conductors to comply with Section 422-30 of the National Electric Code, ANSI/NFPA 70 1987. The disconnecting means must be readily accessible to the tub occupant but installed at least 5 feet (1.5m) from the tub water.

For Units with Gas Heaters

WARNING - Do not install indoors. This unit uses a gas heater that requires proper ventilation and is intended for outdoor use only.

For UL Listed Equipment Assemblies

Install at least 5 feet (1.5m) from tub water using nonmetallic plumbing. Install blower no less than 1 foot (305mm) above the maximum water level to prevent water from contacting electrical equipment. Install in accordance with the installation instructions.

To reduce the risk of drowning from hair and body entrapment, install a suction fitting(s) with a marked flow rate in gallons-per-minute that equals or exceeds the flow rate marked on the equipment assembly.

INTRODUCTION

Congratulations on your new purchase. **Hydro-Quip** Equipment & Control Systems are constructed of the finest materials and assembled under the strictest quality control standards. With proper care and maintenance your system will provide you with many years of reliable performance.

The following pages contain information concerning the operation and care of your system.

(Note: Your Control may differ from the illustration below although the basic operation and configuration will be the same.)

Major Components

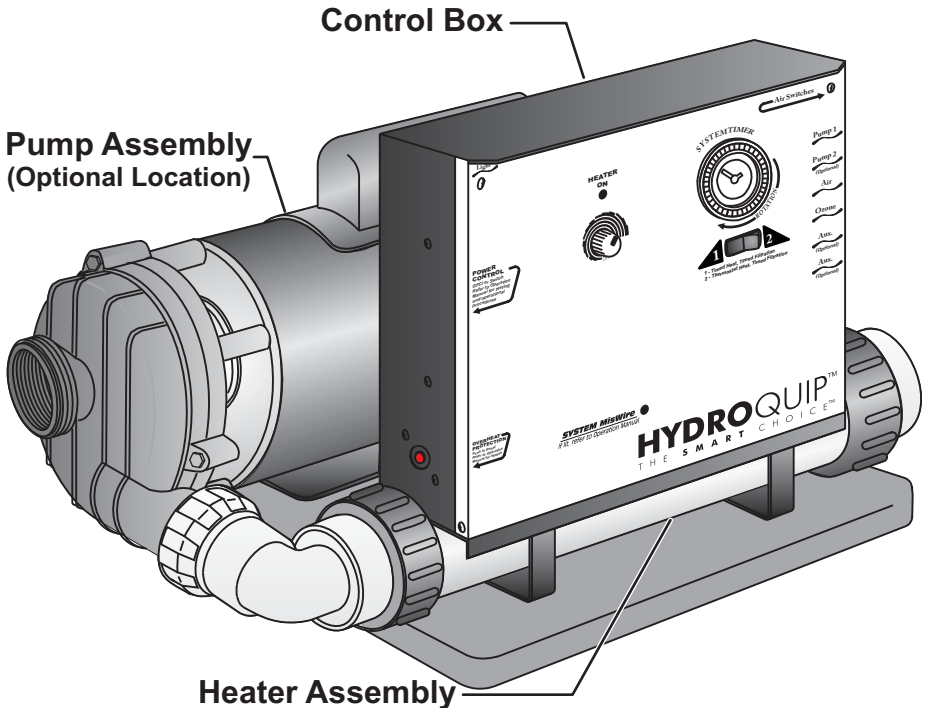

SYSTEM OPERATION

Note: Your particular control may look different than these illustrations though the operation is the same.

Refer to the following pages and the number that corresponds with the number shown in these illustrations for detailed instructions.

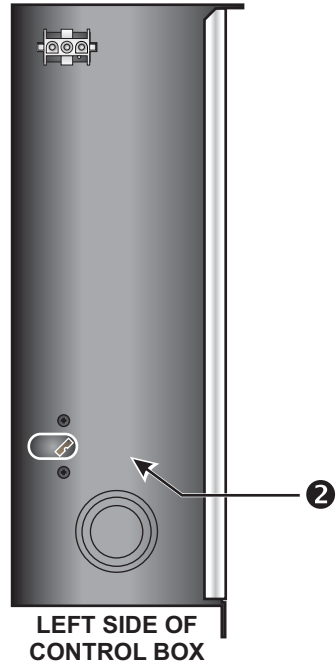

LEFT SIDE OF CONTROL BOX

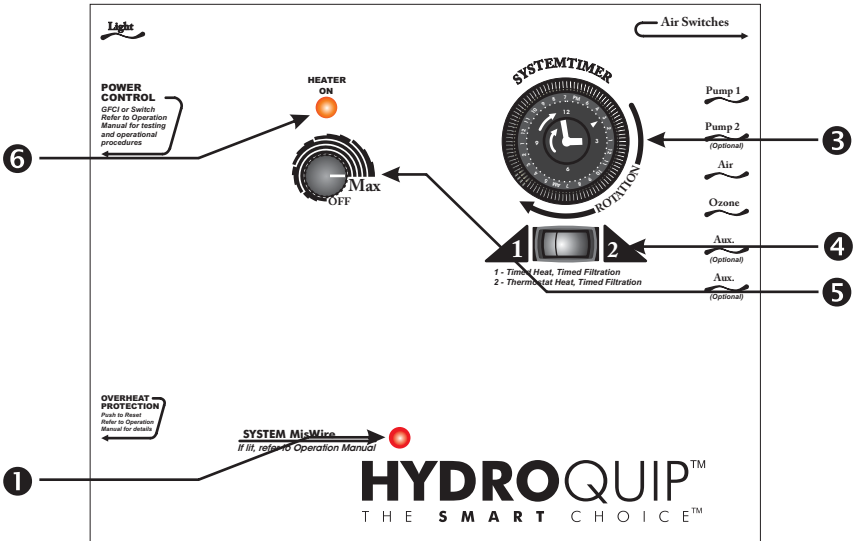

FRONT PANEL

1

SYSTEM MIS-WIRE

This indicator light is a diagnostic tool for the installing electrician. If the system Mis-Wire light is illuminated, this is an indication that L1 or L2 has been connected to the Neutral input. This must be corrected before the circuit will allow operation of the equipment. Once corrected, the circuit will automatically reset and the light will go out.



SYSTEM MisWire

If lit, refer to Operation Manual

2

SYSTEM OVER TEMPERATURE

Note #1: The over temperature reset switch on your particular control may located at the bottom or top left side of the control box.

Note #2: "SLIDE SERIES" control systems incorporate a "Smart High-Limit" safety switch. When equipped the resetting of the switch is done by completely removing power to the spa and allowing time for the switch to reset automatically. Please reference the illustrations to the right for proper installation. If the heater box is pointing up false tripping of the high-limit may occur.

The purpose of these devices are to shut off the equipment if the water temperature reaches 120°F. After the water cools sufficiently (approx 100°F) normal operation may be resumed.

In either case if the switch trips repeatedly, do not use the spa until the problem has been identified and corrected by a qualified technician.

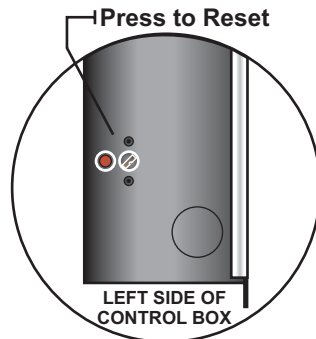

"SLIDE SERIES" HEATER INSTALLATION

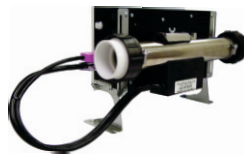

For proper operation of the heater it must NOT be installed with the heater box pointing up.

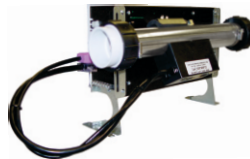

Installing the heater in a horizontal position or with the box pointing down are the only proper installation orientations.

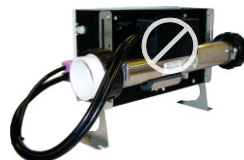

Failure to follow this instruction may result in false tripping of the high limit circuit

3

SYSTEM TIMER (SETTING FILTRATION)

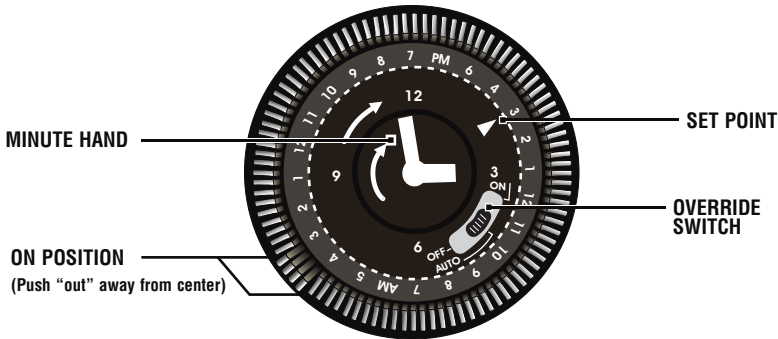

The system timer provides the most efficient and reliable method to filter and heat your spa by activating the low speed of the jet pump during user selectable time periods. Each tripper represents 15 minutes.

Setting the Time

Carefully rotate the minute hand clockwise until the appropriate time setting is achieved. Be sure the set point is correctly indexed to reflect AM/PM.

Override Switch

The timer may be equipped with a manual override switch. There are 3 user settings to choose from:

Auto (default): Pump will run in low speed based on the programmed ON/OFF time set by the trippers.

ON: Pump will run continuously in low speed.

OFF: Timer settings are permanently OFF.

WARNING - Do not set time by rotating outer dial. Do not rotate minute hand counterclockwise.

Set the operating times to provide filtration and/or heating for the number of hours per day recommended by your spa manufacturer. We recommend at least two daily operating periods of not less than 1 hour each and spaced no more than 12 hours apart.

Heavy usage of your spa may require longer periods to maintain water clarity and/or heat. Be sure to set your system timer accordingly.

If you happen to live in an area subject to extreme cold weather conditions, your dealer may recommend that you operate your spa on low speed continuously. This can be accomplished simply by setting all of the trippers or override switch to the "On" position.

We recommend leaving your spa set to PROGRAM MODE 1 for the most energy conservative operation. This mode will allow you to set operating periods during non-sleeping hours or during low cost energy periods.

We recommend PROGRAM MODE 2 for initial heating of your spa and if you wish the spa to be ready for your enjoyment at any time of the day.

You do not need to change or override the timers to utilize the jet or blower modes. Timers control only the low speed heat mode.

4 MODE SELECTION

The System Timer operates in one of two modes. Select the mode that best suits your needs.

PROGRAM MODE 1 - The system timer will activate the low speed of the jet pump filtering the water while the pump is running. The water will be heated according to the thermostat setting only while the timer is on. **While the timer is off heating and filtration will not occur.**

PROGRAM MODE 2 - Operation is the same as PROGRAM MODE 1 except that while the timer is off, the thermostat will maintain the water temperature by automatically cycling the pump and heater on as needed.

Mode Selector Switch



- 1 - Timed Heat, Timed Filtration
- 2 - Thermostat Heat, Timed Filtration

5 THERMOSTAT SETTING

The Thermostat regulates the water temperature in your spa. It is located on the front panel of the control box or on the optional deluxe Spaside Control. Some spas may have both types.

NOTE: When utilizing a topside control as the main system thermostat turn the thermostat on the front of the control system down, NOT OFF. The thermostat on the control system will then act as backup freeze protection should an issue arise with the topside control.

Rotating it fully clockwise will activate the heater and allow a maximum temperature of approximately 104°F. A full counterclockwise rotation will shut off the heater.

Do not expect to feel hot water coming out of the jets while the heater is operating. Refer to "Heater Operation" for information on heat rise.

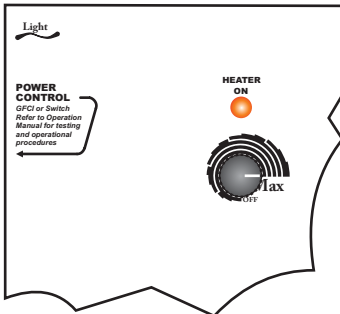

System Mounted Thermostat Spaside Control Thermostat

6

HEATER "ON" INDICATOR

This indicator light activates when the heater is "on". It is a diagnostic tool for service technicians.

HEATER
ON



HEATER OPERATION

Your control system may have a convertible heater (120 volts; or 240 volts). Refer to the system data label to determine which, if any, convertible options are available to you. The heater configuration was set at the factory and may have been changed by your installer.

A covered, 300-gallon spa will experience a heat rise approximately as detailed below.

Your system will operate with one of the following configurations:

120 Volts - The heater will operate on demand at 1500 Watts during low speed pump operation. It will automatically shut off when the high-speed pump or blower is activated. You can expect a heat rise of 1°F to 2°F per hour.

240 Volt - The heater will operate on demand at 5500 Watts during high and low speed pump operation. It will continue to operate when the blower is activated. You can expect a heat rise of 6°F to 8°F per hour.

SPASIDE CONTROL (OPTIONAL)

The optional Spaside Control consists of control buttons for activating the equipment, a thermostat and indicator lights (Deluxe models will include an LED temperature readout).

Depending on how your spa is optioned, it will normally have 2 to 4 control buttons. They usually control the Jet Pump, Secondary Jet Pump, Air Blower and Light.



SPA LIGHT (OPTIONAL)

Your system may include a high intensity, low voltage light to enhance nighttime use.

This illustration shows how and where to find the bulb for replacement. It also shows the mounted spa light with a replacement (colored) lens. Colored lenses will further the enhancement of the light. Simply snap on or off to change the mood of your spa.

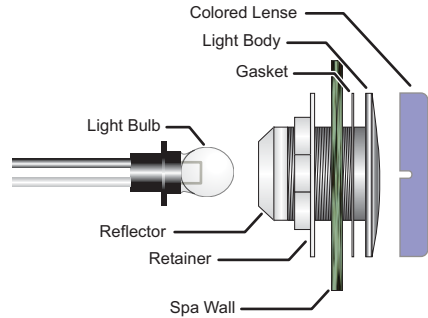

JET PUMP

Your Primary Jet Pump will normally have Two-Speed operation. The low speed is for circulation, filtration and heating. The high speed is for hydrotherapy jet action. Sequence of operation is low speed, high speed then off. *Note: the timer or heater may keep the low speed operating during specific cycles.*

AUXILIARY PUMP (OPTIONAL)

Your system may include an Auxiliary Jet Pump. The pump will have dual or single-speed operation and provides hydrotherapy jet action for additional jets. Sequence of operation will be low speed, high speed then off for a dual speed pump. A single speed pump will operate high speed then off.

AIR BLOWER (OPTIONAL)

Your system may include an air blower. This provides the bubbling action for your spa.

OPERATIONAL CONSIDERATIONS

The following describes situations you may encounter and situations to be aware of.

WARM WEATHER CONDITIONS

Since your spa will normally be expected to maintain warm to hot water to be ready for your use, a great deal of attention has been directed to the **energy conservation** detail of insulation so as to keep electrical costs down. This **energy conservation efficiency** may be achieved by extensive insulating of the skirt, plumbing and spa shell, and in some climates full foam insulation may have been provided.

This **energy conservation** feature may cause an inconvenience during warmer times of the year. During warm periods of the year, the temperature within the equipment compartment can elevate to a point that the pump will automatically turn off for a short period of time (15-30 minutes) to allow the pump to cool down before automatically restarting. This cool down feature will not harm your spa but serves only to protect the pump from damage and as an indicator that it is too hot. To minimize this occurrence, refrain from using your Hydrotherapy Jets for prolonged periods of time during warm seasons.

The jet pump chosen for your spa has been specifically sized for *maximum performance* and your Hydrotherapy enjoyment.

SPASIDE CONTROL BUTTONS

The Control Buttons provided with your new spa are a safe and convenient method to operate the various features of your spa. Allowing children to **PLAY** with these controls will shorten the life of the electrical components and possibly damage the Hydrotherapy Jet Pump and Air Blower. Please assure that these controls are used for the intended purpose and in the correct manner. Failure to properly use these controls may void the manufacturers warranty on affected components.

HIGH WATER TEMPERATURE

There are many factors that can cause your spa water to exceed your desired temperature. The following are the most common causes:

- 🔥 High Outside Temperature
- 🔥 Running the Jets Too Long
- 🔥 Thermostat Setting was Changed
- 🔥 Poor Underskirt Ventilation

FILTRATION

Please refer to your Spa Manufacturer's owner's manual regarding the operation, maintenance and cleaning of your filtration system.

Dirty or clogged filters can cause flow restrictions and you may experience difficulty in reaching and/or maintaining desired heat levels.

CHEMICAL WATER TREATMENT

Your dealer is familiar with local water conditions and which chemicals are compatible with the water and are designed specifically for your spa. This is the best person to advise you on proper water quality management.

The one thing you can do to insure years of trouble free equipment operation is to maintain proper water chemistry.

Two basic goals of the chemical water treatment are sanitizing and balancing the water.

Sanitizing simply means keeping the water free from living microorganisms including algae, bacteria and viruses. The current most popular chemicals for sanitizing include chlorine, bromine and ozone.

Balancing water means establishing a balance among pH, total alkalinity and total hardness. Water that is unbalanced can corrode the spa and it's support equipment or leave deposits of minerals. Properly balanced water is essential to allow the sanitizing chemical to work effectively. There are numerous chemical additives to help you in controlling pH, total hardness and total alkalinity. **NEVER** use softened water when filling your spa. Softened water is extremely corrosive to the metal parts of the spa equipment and may lead to an unforeseen failure.

Sometimes, despite your most diligent efforts, your water may become too far out of balance to be managed chemically. At this point it is probably better to drain and clean the spa and start over with fresh water.

Equipment failure caused by improper water chemistry will not be covered under warranty.

FREEZE PROTECTION & WINTERIZING

When freezing weather and/or power losses are expected, contact your local spa dealer for freeze protection operation or winterizing recommendations for both the spa and the equipment system. Freeze related damage is not covered by the Hydro-Quip warranty.

TROUBLESHOOTING

*The following describes situations and possible solutions to common problems may encounter as a spa owner. **Note: your system may not include all components listed.***

NOTHING OPERATES

System Mis-Wire is ON - Refer to Page 6 or contact your local dealer.

Main Breaker is OFF - Set to On.

Sub-Panel Breaker Off - Set to On.

Equipment GFCI Off - Set to On.

Power switch in Off position - Set to On.

Components not plugged in - Plug in components.

Power cord not plugged in - Plug in power cord.

Overheat Protection Switch Tripped - Refer to Page 6 or contact your local dealer.

NO, LOW OR SURGING WATER FLOW

Air Lock in Plumbing System - "Bleed" the system.

Restricted Flow - Insure that the water shut-off valves are open and that suction fittings are not blocked by debris.

Dirty Filter - Clean or replace filter.

Low Water Level - Increase water level to recommended level.

NO LOW SPEED PUMP OPERATION

Timer Not Programmed - Set function mode to desired setting and program timer.

Overheat Protection Switch Tripped - Press button to reset.

Mode Switch Set in Mode 2 - Thermostat needs to be turned up to desired temperature.

Pump Not Plugged-In - Plug in the Pump.

Auxiliary Fuse Blown - Contact you local dealer.

NO JETS OR BLOWER OPERATION

Air Button / Air Switch Hose Not Connected - Connect hose.

Blower or Pump Not Plugged-In - Plug in the Blower or Pump.

Overheat Protection Switch Tripped - Press button to reset.

Auxiliary Fuse Blown - Contact you local dealer.

NO THERAPY JET OPERATION

Water Shut-Off Valves are Closed - *Open Shut-Off valves.*

Dirty Filter - *Clean or replace filter.*

Jets Not Properly Adjusted - *Adjust Jets properly.*

Diverter Valve Not Properly Adjusted - *Adjust diverter valve properly.*

Thermal Overload Tripping - *Check for restricted flow of water.*

Overheat Protection Switch Tripped - *Press button to reset.*

Air Button / Switch Hose Not Connected - *Connect hose.*

NO LIGHT OPERATION

Light Bulb Defective - *Replace bulb or contact your local dealer.*

Reflector has Fallen Off - *Replace deflector or contact your local dealer.*

Light Not Plugged-In - *Plug in the Light.*

Air Button / Switch Hose Not Connected - *Connect hose.*

WATER LEAKS

Spa Overfilled - *Adjust water level.*

Too Many People in the Spa - *Adjust water level.*

Drain-Valve Left Open - *Close drain valve.*

Couplings or Unions Loose - *Tighten or contact your local dealer.*

Pump Seal Leaking - *Contact your local dealer.*

Plumbing / Connections Leaking - *Contact your local dealer.*

Water Leaking from Spaside Control - *Contact your local dealer.*

Water in Air Blower Plumbing - *Contact your local dealer.*

NO HEAT

Temperature Not Set Correctly - *Adjust Thermostat setting.*

Overheat Protection Switch Tripped - *Press button to reset.*

System in Wrong Mode - *120V Systems will not heat if High Speed or Blower is on.*

No Power - *Reset breaker at service panel.*

Low Water Flow - *Clean or Replace filter.*

Pressure Switch Not Adjusted Properly - *Contact a qualified technician.*

HIGH HEAT

Temperature Sensor Not in Dry-Well - *Place sensor in dry-well.*

Temperature Set Too High - *Adjust Thermostat Setting.*

High Ambient Temperature - *Remove spa cover.*

GFCI TRIPS OCCASIONALLY

Lightning or Electrical Storm, Power Surge, Extremely Humid Conditions, or Radio Frequency Interference - Reset GFCI.

NOTE: GFCI must be properly grounded and bonded.

GFCI TRIPS IMMEDIATELY

Defective Component - Contact a qualified service technician or the factory for assistance.

SYSTEM DATA LABEL

The system data label is located on the control box. This label is very important and contains information you will need to establish your electrical service. The voltage and amperage ratings are shown on the bottom of the label. Product, Model, Serial and Code numbers are also shown on the label.

Note: *This information will be necessary if you should ever have to request warranty or any other type of service.*



HYDROQUIP™
THE **SMART CHOICE™**

ORDER CODE: _____

MODEL: _____

SERIAL: _____

CODE: _____

VOLTS: _____

AMPS: _____

PRODUCT: _____

**REFER TO NEC FOR
BREAKER SIZING**

WARRANTY INFORMATION

To all original purchasers, **HYDROQUIP** warrants its products to be free from defects in material and workmanship for a period of one year from the date of purchase.

HYDROQUIP will repair or replace the part, which in our opinion, is defective.

This warranty excludes damage as a result of: normal wear, freezing, low voltage, chemical abuse, accident, negligence, alteration, improper installation, use or care.

To obtain warranty service, return defective products within the warranty period to **HYDROQUIP**.

Purchaser is responsible for removal or reinstallation labor, freight charges, or any other such costs incurred in obtaining warranty service.

HYDROQUIP assumes no responsibility for incidental or consequential damages. Some states do not allow the exclusion of incidental or consequential damages, so the above limitations and exclusions may not apply to you. This warranty gives you specific legal rights and you may also have other rights, which vary from state to state.

**THE SPA DEALER MAY PROVIDE A DIFFERENT WARRANTY,
CONTACT YOUR SPA DEALER FOR DETAILS**



HYDROQUIPTM

510A N. Sheridan Street • Corona, CA 92880-2024

Email: info@hydroquip.com • Internet: <http://www.hydroquip.com/>

Telephone: 951.273.7575 • Fax: 800.332.7190