

Operating instructions for the system user

VIESSMANN

Wireless remote control for one heating circuit

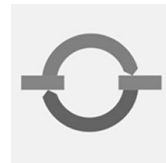

VITOTROL 200 RF

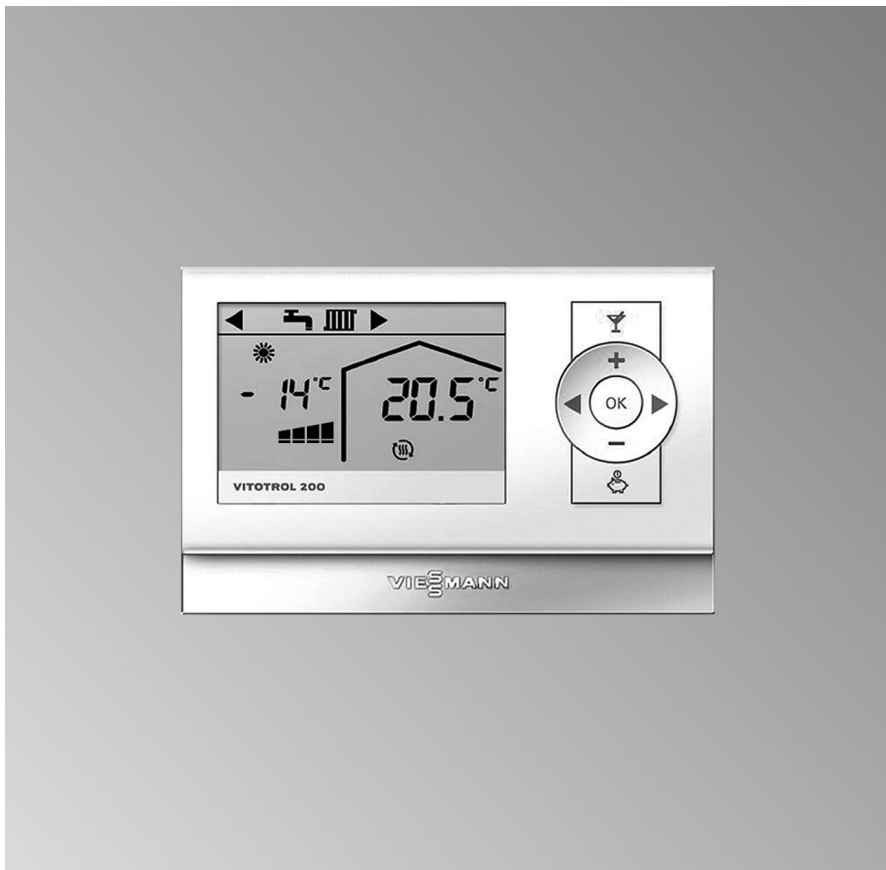

Safety instructions

For your safety



Please follow these safety instructions closely to prevent accidents and material losses.

Safety instructions explained



Danger

This symbol warns against the risk of injury.



Please note

This symbol warns against the risk of material losses and environmental pollution.

Note

Details identified by the word "Note" contain additional information.

Target group

These operating instructions are for the heating system user.

This unit is **not** designed to be used by persons (including children) with limited bodily, sensory or mental capacities, or lacking experience and/or lacking knowledge, unless they are supervised by a person responsible for their safety, or have received instructions from such a person as to how to use the unit.



Please note

Children should be supervised. Ensure that children do not play with the unit.



Danger

Incorrectly executed work on the heating system can lead to life-threatening accidents.

- Work on gas appliances must only be carried out by a registered gas fitter.
- Work on electrical equipment must only be carried out by a qualified electrician.

If you smell gas



Danger

Escaping gas can lead to explosions which may result in serious injury.

- Do not smoke. Prevent naked flames and sparks. Never switch lights or electrical appliances ON or OFF.
- Close the gas shut-off valve.
- Open windows and doors.
- Remove all people from the danger zone.
- Notify your gas or electricity supplier and your heating contractor from outside the building.
- Shut off the electricity supply to the building from a safe place (outside the building).

For your safety (cont.)

If you smell flue gas



Danger

Flue gas can lead to life-threatening poisoning.

- Shut down the heating system.
- Ventilate the boiler room.
- Close all doors in the living space.

In case of fire



Danger

Fire creates the risk of burning and explosions.

- Shut down the heating system.
- Close the shut-off valves of the fuel lines.
- Use a tested fire extinguisher, class ABC.

Boiler room requirements



Please note

Incorrect ambient conditions can lead to damage to the heating system and put the safe operation at risk.

- Ensure ambient temperatures above 0 °C and below 35 °C.
- Prevent air contamination by halogenated hydrocarbons (e.g. as contained in paints, solvents or cleaning fluids) and excessive dust (e.g. through grinding/polishing work).
- Avoid continuously high humidity levels (e.g. through frequent drying of washing).
- Never close existing ventilation apertures.

Ancillary components, spare and wearing parts



Please note

Components that are not tested with the heating system may lead to damage to the heating system, or may affect their various functions.

Installation or replacement work must only be carried out by qualified personnel.

Index

Index

Introductory information

Commissioning.....	5
Terminology.....	5
Tips on saving energy.....	6

Operation

Operating information.....	7
Controls.....	7

Central heating

Required settings.....	9
Setting the room temperature for standard heating mode.....	9
Setting the heating program.....	9

Comfort and energy saving functions.....	10
---	-----------

What to do if...

Rooms are too cold.....	12
Rooms are too hot.....	12
There is no hot water.....	13
"△" is displayed.....	13
"△" and "----" are displayed.....	13
∅ is displayed.....	14
Changing the batteries.....	14

Appendix

Terminology.....	16
------------------	----

Keyword index.....	18
---------------------------	-----------

Commissioning

Your remote control is connected to the Vitotronic control unit of the boiler by means of a wireless connection. The commissioning and adjusting of the Vitotronic control unit to local conditions and to the structural characteristics of the building, plus the instruction of the user in operating the system, must be carried out by your heating contractor. The settings made at the Vitotronic control unit are transferred to the remote control during commissioning. The Vitotronic control unit is factory-set to **"Heating and DHW"**.

In other words, the rooms that you are controlling with your remote control are heated in accordance with the time program that has been set at the Vitotronic control unit, alternating between standard and reduced room temperature. DHW heating will also take place in accordance with the settings from the Vitotronic control unit.

Power failure

- All data is saved if there is a power failure.



Terminology

To provide you with a better understanding of the functions of your remote control unit, the appendix contains a chapter entitled "Terminology".

Introductory information

Tips on saving energy

Use the setting options offered by the remote control:

- Never overheat your rooms. Every degree by which the room temperature is reduced saves up to 6 % on heating costs.
Never set your room temperature higher than 20 °C.
- Select the heating program that meets your current requirements:
 - For short absences (e.g. shopping trips), select economy mode  (see page 10).
As long as economy mode is activated, the room temperature is reduced.
 - In the summer, if you do not want to heat any rooms but require hot water, select the heating program  (see page 9).
 - If you do not want to heat any rooms and require no hot water for a prolonged period of time, select  (see page 9).

Further recommendations:

- Correct ventilation.
Briefly open windows fully and at the same time close the thermostatic valves.
- Close roller shutters (if installed) at dusk.
- Set thermostatic valves correctly.
- Never cover radiators or thermostatic valves.
- Controlled DHW consumption: A shower generally uses less energy than a full bath.

Operating information

The Vitotrol 200 RF remote control unit enables the following adjustments to be made from the living space:

- Standard room temperature
- Heating program

All other settings are transferred from the Vitotrol 200 RF to the Vitotronic control unit and vice-versa. The **most recent** adjustments always apply to your heating circuit.

Controls

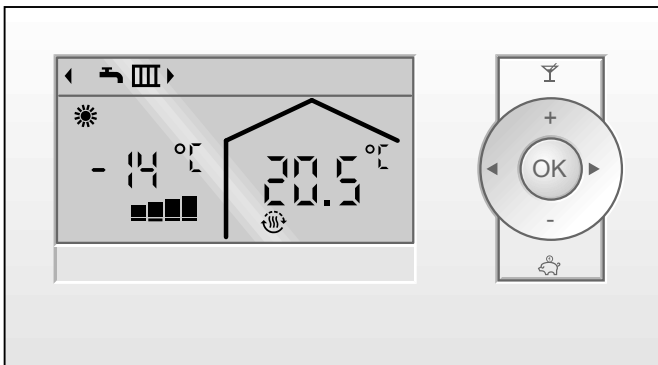

- + Increases the standard room temperature.
- Reduces the standard room temperature.
- ◀▶ You set the heating program.
- OK** You confirm your selection or setting.
- 🍷 You activate party mode.
- 🐷 You activate economy mode.

Operation

Controls (cont.)

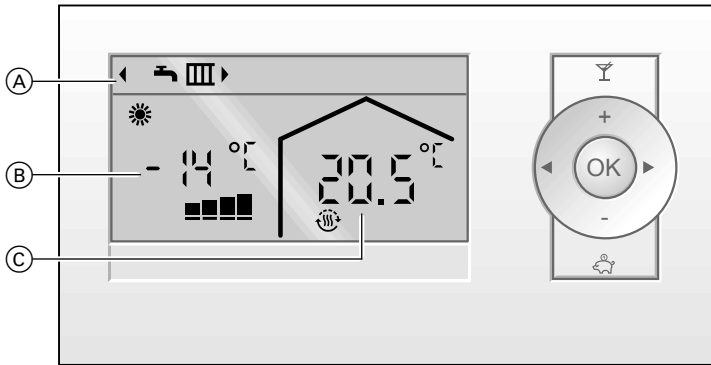

- (A) Header (heating program display)
- (B) Current outside temperature
- (C) Current room temperature (actual room temperature)

Symbols on the display

These symbols are not permanently displayed, but appear subject to the system version and the operating state.

Heating program (display in the header)

- ☉ Standby mode with frost protection monitoring
- ☀ DHW heating only
- ☀☀ Central heating and DHW heating
- ☀☀☀ Party mode active
- ☀☀☀☀ Economy mode active
- ⏪⏩ Heating program settings

Displays

- ☀ Frost protection monitoring
- ☀☀ Central heating with standard room temperature
- ☀☀☀ Central heating with reduced temperature
- ☀☀☀☀ Heating circuit pump runs
- ☀☀☀☀☀ Holiday program enabled
- ☀☀☀☀☀☀ In conjunction with a solar thermal system:
Solar circuit pump runs

- ◆ When selecting the set room temperature
- ☀☀☀☀ Wireless connection (transmitting icon)
- ☀☀☀☀☀☀ Quality of the wireless connection (see page 13)

Messages

- ⚠ Fault message
- 🔒 Operation blocked, except activating party mode
- 🔋 Change the batteries (see page 14)

Required settings

If you want central heating, check the following points:

- Have you set the required room temperature (set room temperature)?
- Have you set the correct heating program?

For settings, see the next chapter.

Setting the room temperature for standard heating mode

Factory setting: 20 °C

Press the following keys:

1. +/- for the required set room temperature.

2. OK to confirm.



The display shows the current room temperature (actual room temperature).

Setting the heating program



Factory setting:

"" for central heating and DHW heating (winter mode).

Heating programs:

-  Standby mode with frost protection monitoring
-  Only DHW heating (summer mode)
-  Central heating and DHW heating

Press the following keys:

1.  the symbol for the current heating program flashes.
2.  until the symbol for the required heating program flashes.
3. OK to confirm.

Comfort and energy saving functions

Comfort and energy saving functions

Selecting comfort mode

With this function, you can change the room temperature for several hours, e.g. if guests unexpectedly stay longer in the evening. With this function, DHW is boosted to the set temperature selected at the Vitotronic control unit.

1. If you want to select a different room temperature during party mode:
Set the required room temperature (see chapter "Setting the room temperature").

Note

This value is retained even after party mode is terminated.

2. Press .

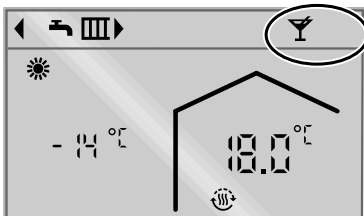

Terminating the comfort function

- Press 
or
- Automatically after 8 hours
or
- Automatically when the system switches to standard heating mode in accordance with the time program selected on the Vitotronic control unit.

Selecting energy saving function "Economy mode"

To save energy, you can reduce the room temperature in standard heating mode ( must be shown on the display). For example, if you leave the house for a few hours.

Note

Economy mode cannot be selected whilst operating with reduced room temperature.

Press .

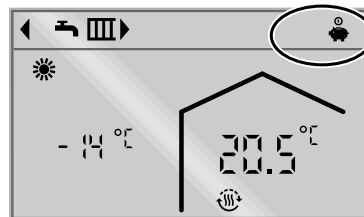



Comfort and energy saving functions (cont.)

Terminating economy mode

- Press 
or
- Automatically when the system switches to reduced heating mode in accordance with the time program selected on the Vitotronic control unit.

What to do if...



Rooms are too cold

Cause	Remedy
Remote control set incorrectly.	Check settings and correct if required: <ul style="list-style-type: none">■  must be selected (see page 9).■ Set room temperature (see page 9).
No fuel.	With oil/LPG: Check the fuel reserves and re-order if required. With natural gas: Open the gas shut-off valve. If necessary, check with your gas supply utility.
"△" is displayed.	Scan and acknowledge the type of fault at the Vitotronic control unit. If necessary, notify your heating contractor.  Control unit operating instructions

Rooms are too hot

Cause	Remedy
Remote control set incorrectly.	Check the set room temperature and correct if required (see page 9).
"△" is displayed.	Scan and acknowledge the type of fault at the Vitotronic control unit. If necessary, notify your heating contractor.  Control unit operating instructions

There is no hot water

Cause	Remedy
Remote control set incorrectly.	Check that DHW heating has been enabled.  or  must be selected (see page 9).
No fuel.	With oil/LPG: Check the fuel reserves and re-order if required. With natural gas: Open the gas shut-off valve. If necessary, check with your gas supply utility.
"△" is displayed.	Scan and acknowledge the type of fault at the Vitotronic control unit. If necessary, notify your heating contractor.  Control unit operating instructions

"△" is displayed

Cause	Remedy
Heating system fault.	Scan and acknowledge the type of fault at the Vitotronic control unit. If necessary, notify your heating contractor.  Control unit operating instructions

"△" and "----" are displayed

Cause	Remedy
Wireless connection interference or interruption.	Contact your local heating contractor.

What to do if...

⏻ is displayed

Cause	Remedy
The batteries are spent.	Change the batteries (see next chapter). The Vitotrol 200 RF has a power reserve. All set data is retained while the batteries are replaced.

Changing the batteries

- Use batteries of type Mignon LR6/AA, 1.5 V.
- Never use rechargeable batteries.

Removing the Vitotrol

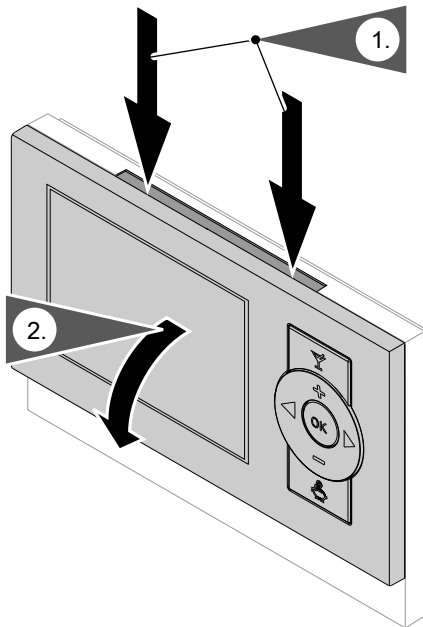

Changing the batteries (cont.)

Changing the batteries

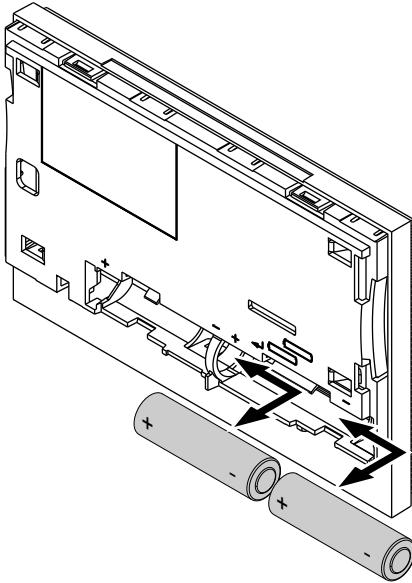

Disposal

Always dispose of spent batteries via an authorised collection site.

Appendix

Terminology

Setback mode (reduced heating mode)

See "Reduced heating mode".

Heating program

With the heating program you determine whether you heat your rooms and DHW, or only heat DHW, or whether you shut down your heating system with frost protection monitoring.

You can select the following heating programs:



The rooms are heated and DHW is provided (winter mode).



DHW is provided but there is no central heating (summer mode).



Frost protection is enabled; no central heating, no DHW heating.

Operating status

In the heating program , the operating status changes from "Standard heating mode" to the operating status "Reduced heating mode" and vice versa. The times for the operating status changeover are defined when the time program is set at the Vitotronic control unit.

Heating circuit

A heating circuit is a sealed circuit between the boiler and radiators, in which the heating water circulates.

A heating system may comprise several heating circuits. For example, one heating circuit for the rooms occupied by you and one heating circuit for the rooms of a separate apartment.

Heating circuit pump

Circulation pump for the circulation of the heating water in the heating circuit.

Actual temperature

Current temperature at the time of the scan; e.g. actual room temperature.

Mixer

A mixer mixes the water heated in the boiler with the cooled water returning from the heating circuit. The water, heated to the right temperature in line with demand, is pumped to the heating circuit by the heating circuit pump. The Vitotronic control unit adjusts the heating circuit flow temperature via the mixer to suit the various conditions, e.g. different outside temperature.

Night setback

See "Reduced heating mode".

Standard heating mode

When you are in the house during the day, you can heat the rooms in standard heating mode. Set the periods with the time program for central heating at the Vitotronic control unit. During these periods, the rooms are heated to the standard room temperature.

Terminology (cont.)

Standard room temperature

When you are in the house during the day, set the standard room temperature (see page 9).

Reduced heating mode

When you are out or during the night, you can heat the rooms in reduced heating mode (setback mode). Set the periods with the time program for central heating at the Vitotronic control unit. During these periods, the rooms are heated to a reduced room temperature.

Reduced room temperature

When you are out or during the night, select the reduced room temperature on the Vitotronic control unit. See also "Reduced heating mode".

Solar circuit pump

In conjunction with solar thermal systems. The solar circuit pump delivers the cooled heat transfer medium from the DHW cylinder indirect coil to the collectors.

Set temperature

Specified temperature that should be reached, e.g. set room temperature (see page 9).

Summer mode

Heating program "**Only DHW**".

At warmer times of the year, i.e. when rooms do not have to be heated, you can disable heating mode. The boiler remains operational for DHW heating.

Cylinder primary pump

Circulation pump for heating the DHW in the DHW cylinder.

Keyword index

Keyword index

A		N	
Actual temperature.....	16	Night mode.....	16
		Night setback.....	16
C		O	
Central heating.....	8	Operating information.....	7
Comfort function, party mode.....	10	Operating procedure.....	7
Controls.....	7	Operating status.....	16
Cylinder primary pump.....	17		
D		P	
Day mode.....	16	Party mode	
Display elements.....	8	■ Activating.....	10
		■ Terminating.....	10
E		Power failure.....	5
Economy mode		Programming unit.....	7
■ Activating.....	10	Pump	
■ Terminating.....	11	■ Cylinder.....	17
Energy saving function, economy mode.....	10	■ Heating circuit.....	16
		■ Solar circuit.....	17
F		R	
Factory pre-sets.....	5	Reduced heating mode.....	17
Factory setting.....	5	Reduced room temperature.....	17
Fault message.....	8	Rooms are too cold.....	12
Frost protection monitoring.....	8	Rooms are too hot.....	12
		Room temperature	
G		■ Reduced.....	17
Glossary.....	16	■ Standard.....	17
		S	
H		Saving energy	
Heating and DHW.....	5	■ Economy mode.....	10
Heating circuit.....	16	■ Tips.....	6
Heating circuit pump.....	16	Setback mode.....	16, 17
Heating mode		Set temperature.....	17
■ Reduced.....	17	Settings for central heating.....	9
■ Standard.....	16	Setting the heating program.....	9
Heating program.....	16	Setting the room temperature.....	9
		Solar circuit pump.....	17
M		Standard heating mode.....	16
Mixer.....	16	Standby mode.....	16

Keyword index (cont.)

Starting

- Central heating.....9
- Comfort function.....10
- Energy saving function.....10

Stopping

- Comfort function.....10
- Economy mode.....11
- Summer mode.....9, 16, 17
- Symbols on the display.....8

T

Temperature

- Actual temperature.....16
- Set temperature.....17
- Terminology.....5, 16

W

- Water stays too cold.....13
- Winter mode.....9, 16

Your contact

Contact your local contractor if you have any questions regarding the maintenance and repair of your system. You may, for example, find local contractors on the internet under www.viessmann.com.

Viessmann Werke GmbH&Co KG
D-35107 Allendorf
Telephone: +49 6452 70-0
Fax: +49 6452 70-2780
www.viessmann.com

Viessmann Limited
Hortonwood 30, Telford
Shropshire, TF1 7YP, GB
Telephone: +44 1952 675000
Fax: +44 1952 675040
E-mail: info-uk@viessmann.com

5592 697 GB Subject to technical modifications.



Printed on environmentally friendly,
chlorine-free bleached paper