

Navitas On-Roof Installation Manual 2.0m² & 2.5m² Portrait & Landscape Systems



**REGISTER THIS PRODUCT
ONLINE WITHIN 28 DAYS OF
COMMISSIONING**

IRELAND



www.joule.ie/register-a-product

UNITED KINGDOM



www.jouleuk.co.uk/register-a-product

JL-NAVOR-INS-001-03-2017



Warranty Card

Please register your product online



**MUST BE COMPLETED AND
THEN REGISTERED ONLINE
TO COMPLETE WARRANTY**

Homeowner Name

Installer Name

Address

Address

Contact Tel.

Contact Tel.

Contact Email

Contact Email

Product	Product Installed	Serial Number		Installation Date
Cylinder	<input type="radio"/>		Located on cylinder badge	
Solar Thermal	<input type="radio"/>		Take from solar controller	
Solar PV	<input type="radio"/>		Ser. No. from String / Micro Inverter	
Air Source Heat Pump	<input type="radio"/>		Located on external heat pump badge	
Integrated Heat Pump and Cylinder	<input type="radio"/>		Located on cylinder badge	
Underfloor Heating	<input type="radio"/>		Project ref. on supplied schematic	
Intergas Gas Boiler	<input type="radio"/>		Located on cylinder badge	
Was a Pre-Plumbed cylinder installed too?	<input type="radio"/>			

Joule Advance Installer

I accept the terms and conditions in the installation manual

Joule Product Warranty Terms & Conditions

Subject to the following provisions, Joule warrants that the Goods will be free from defects in material and workmanship for a period of 20 years in relation to VACUUM TUBES and PANELS a period of 5 years for MANIFOLDS and KITS from their date of manufacture. "RESTRICTED PRODUCTS" are limited to a period of 12 months warranty. The warranty is given by Joule subject to the following conditions:

- A Joule shall be under no liability in respect of any defect in the Goods arising from any information drawing design or specification supplied by the Buyer.
 - B Joule shall be under no liability in respect of any defect arising from fair wear and tear, wilful or accidental damage, negligence, abnormal working conditions, failure to follow the Joule' instructions, misuse or alteration or repair of the Goods without approval.
 - C The above warranty does not extend to parts materials equipment not manufactured by Joule Renewables in respect of which the Buyer shall only be entitled to the benefit of any such warranty or guarantee as is given by the manufacturer to the Company.
 - D The defect has been reported by the Buyer to Joule within the warranty period.
 - E The installation of the Goods having been carried out by fully trained and competent person(s).
 - F The Goods having been subjected to neither "prolonged stagnation conditions" nor exhibiting signs of "extreme temperature exposure".
1. The Buyer shall not make any statement or representation or give any warranty to any third party in respect of any, Goods other than in the terms made or given by Joule to the Buyer nor shall the Buyer have any authority to commit Joule to provide any service in relation to the Goods.
 2. The Company's liability to the Buyer for death or injury resulting from its own or that of its employees' agents' or subcontractors' negligence and damage suffered by the Buyer as a result of any breach of the obligations implied by Section 12 of The Sale of Goods Act 1979 shall not be limited.
 3. If Joule fails to deliver the Goods for any reason other than any cause beyond the Company's reasonable control or the Buyer's fault then Joule shall only be liable to the Buyer for and the Company's liability shall be limited to the excess (if any) of the cost to the Buyer (in the cheapest available market) of similar goods to replace those not delivered over the Price of the Goods.
 4. The Buyer shall examine all delivered Goods forthwith. Any claim based on any defect in the quality or condition of the Goods or their failure to correspond with specification shall be notified to Joule within 7 days from the delivery date or where the defect was not apparent on reasonable inspection within a reasonable time after discovery of the failure. If delivery is not refused and the Buyer does not notify Joule the Buyer shall not be entitled to reject the Goods.
 5. Joule shall be entitled to examine any Goods, which are the subject of any claim by the Buyer, and to remove such Goods or any part thereof for testing. No tests carried out by the Buyer will be recognised by Joule unless carried out strictly in accordance with a method previously agreed by Joule as being suitable for the purpose.
 6. Any valid claim in respect of the Goods which is based on any defect in the quality or condition of the Goods or their failure to meet specification is notified to Joule in accordance with these Conditions Joule shall be entitled to repair or replace the Goods (or the part in question) free of charge or at the Company's sole discretion refund to the Buyer the Price (or a proportionate part of the Price) but Joule shall have no further liability to the Buyer.

7. Joule shall not be liable to the Buyer by reason of any representation (unless fraudulent) or any implied warranty condition or other term or any duty at common law (including but without limitation the negligence of Joule its employees agents or otherwise) or under the express terms of the Contract for any loss of production loss of profits or anticipated profits loss of contracts operation time or anticipated savings loss of business or of expected further business loss of or corruption to data damage to the Buyer's reputation or goodwill damages costs or expenses payable by the Buyer to any third party or any other indirect special or consequential loss or damage or claim (whether caused by the negligence of Joule its employees agents or otherwise) which arise out of or in connection with the supply of the Goods or their use or resale by the Buyer.
8. Without prejudice to the provisions of clauses 3, 4, 5, 6 and 7 the entire liability of the Buyer under or in connection with the Contract shall not exceed the Price of the Goods.
9. Joule shall not be liable to the Buyer or be deemed to be in breach of the contract by reason of any delay in performing or any failure to perform any of the Company's obligations in relation to the Goods if the delay or failure was due to any cause beyond the Company's reasonable control. Without limiting the foregoing, due to causes beyond the Company's reasonable control.
10. For comprehensive details regarding "Warranties and Liability" please refer to the "CONDITIONS OF SALES" available to view on our website.

Table Of Contents

6	Pre-Installation Notes
7	First Fix Notes
10	Standard Kit Components
13	Connection Setup For Panels
14	UK Pack Components
15	IE Pack Components
16	Solar Pipe Components
17	Setting Out The Roof
18	Roof Mounting Instructions
19	Sloped Roof - Bolt Mounting Kit
20	Sloped Roof - Tile Mounting Kit
21	Flat Roof - Mounting Kit
22	Sloped Roof - Slate Mounting Kit
24	Finishing Roof Work <ul style="list-style-type: none">• Inserting Temperature Probe Into The Panel• Connecting Solar Pipe To The Panels
26	Single Orientation Single Cylinder <ul style="list-style-type: none">• Under Roof Remaining Work• Wiring The System• Commissioning The System
28	Dual Orientation Single Cylinder <ul style="list-style-type: none">• Under Roof Remaining Work• Wiring The System• Commissioning The System
30	Single Orientation Dual Cylinder <ul style="list-style-type: none">• Under Roof Remaining Work• Wiring The System• Commissioning The System
32	Service Record



Do not crosswire the power cable with the comms cable on the solar pump. If you do this you will see a flashing green light on the pump. The pump will not operate. The pump will be rendered obsolete and will need to be replaced with a new pump. This is not covered under a product warranty.

Pre-Installation Notes

Solar hot water systems should be designed and sized correctly before commencing the installation. Proper design will ensure that a system is correctly sized to provide many years of optimised performance and most or all of the required hot water when the most solar radiation is available. However a supplementary heating system such as oil or gas boiler, heat pump or wood boiler is required for months that have less solar radiation. This guide will illustrate and explain how a system should be installed to conform to the Joule manufacturer guidelines for the Navitas/Acapella/Vis-Solis product models. Using this guide, stages of a solar installation will be described in the following pages, with illustrations where necessary to explain how to install the relevant components, and contains general recommendations and important safety information.

Handling Guidance

- Tube, manifold and panel boxes should be transported horizontally
- Heavy goods should not be loaded on top of the kit boxes
- Care should be taken when opening boxes to prevent scratches or sudden shocks to the glass.
- Do not use sharp objects to open the packaging

Installation Guidance

- Unpack and install tubes and /or panels only after the manifold and pipe work has been installed
- Do not leave the solar collector exposed to solar radiation when the solar loop and manifold have been drained.
- If installing tubes they must have a minimum elevation of 20 degrees and a maximum of 70 degrees. The pipe work of the solar collector loop is to be earthed and the collector is to be lightning protected in accordance to local regulations.
- A solar panel installation must be performed in accordance with all Health & Safety legislation and local building/planning regulations for the relevant jurisdiction. Furthermore, the necessary electrical work required to install control equipment should be undertaken by a qualified electrical contractor.

Sizing of safety equipment

Component sizes are relative to the volume of liquid in the system

Pipe sizing (minimum of 15 mm diameter pipework must be used).

Flow Rate And Pressure Calculation					
No. of Tubes	Flow Rate ltr/hr	Pipe Diameter Copper External ("BSP)	1 Panel System (mbar)	2 Panel System (mbar)	3 Panel System (mbar)
20	120	3/4" M	8.54	1.18	4.11
30	240	3/4" M	17.08	2.36	8.22
40	360	3/4" M	25.14	5.74	20.94

First Fix Notes

Degree of Over Shading

None / Little / A lot

Shading will reduce the overall performance of a solar system. During the planning stage of a solar system, consideration should be given to the location of the collectors with the aim of minimising the effects of shading from high buildings, trees, etc.

Collector Fixing Surface

Is there enough room for the solar panels to sit on the required roof?

yes/no

Is there enough between gulleys (top, bottom and both sides) to prevent leaves and debris from gathering around the panels?

yes/no

Orientation of Roof & Est. Tilt Angle of Roof for Mounting Solar Collectors

What is the Roof orientation (should be between East SE - West SW)

Collector should be facing the equator

Is an inclined roof frame need to obtain required pitch?

yes/no

To calculate optimal angle of tilt multiply latitude x 0.7 for domestic hot water production

Estimating Hot Water Demand & Size of System Required

No. of people using hot water in the house

Any other exceptional water loads in the dwelling

No. of People	Solar Cylinder Size	Size of Flat Panel System	Size of Evacuated Tube
1-2 people	200 litres	2 Panel System (4m ²)	30 Tube
3-5 people	300 litres	3 Panel System (6m ²)	40 Tube

Location of Solar Pump Station & Solar Controller

Ensure the pump station is located in an area where it can be easily accessed for servicing & maintenance

Ensure that there is adequate space both left and right of pump station to allow easy access to remove pump in future.

Ensure that the solar controller is located in an easily accessible area for the user

Ensure that the controller is mounted at the correct height for ease of viewing.

First Fix Notes

Safe Roof Access To Work

- Is there adequate access to area of house to mount scaffolding or ladders? yes/no
- Is there steady and secure base on which to mount scaffolding or ladders? yes/no
- Are the scaffolding and/or ladders fit for purpose? yes/no
- Are all installers trained in working at heights? yes/no
- Are all harness and other safety equipment working correctly? yes/no

All work carried out should be in accordance with all relevant good practices and or current building standards. All current regulations should be followed in relation to working at heights. Nothing stated in this guide takes precedence over current standards.

Condition of Roof

- What are the centres of the roof rafters where the solar collector is to be mounted (e.g. 400mm)? mm
- What is the size of roof rafters (e.g. 6x2", 7x2", 8x2")? inch
- Are roof rafters cross braced? yes/no
- Is any of the timber showing discolouration (indicating rot)? yes/no

To determine the total load on the roof you must get the total weight of the collectors and divide this weight by the number of roof fixing bolts or anchors used to hold the collector on the roof. This will give you the weight of the solar panels on each point of the roof. You must then carefully review the points where the collectors are connected to the roof to ensure that these exact points can take the anticipated load.

Where there is signs of discolouration a closer examination will be required. If black spots are found on the timber this indicates a leak which needs attention. If the timber appears brown and flaky then the timber may need to be replaced. If the situation is unclear a structural engineers report should be obtained prior to completing any further work.

Effects of Snow Loads

- What is the estimated annual snow fall for this part of the country? mm
- What is the total extra weight to be assumed from a snow fall? kg

Irish/UK snow weighs approx 150kg per m³. To determine the extra weight the snow will add to the solar panels you may assume the following formula. (snow fall in meters x area of panel on the roof in m² x 150kg/m³)

When you find out the total extra weight of the snow add it to the total weight of the collector on the roof. Then using this new weight to examine the roof structure to ensure its suitability. You do not need to consider the snow load when installing evacuated tubes.

Effects of Wind Load

The evacuated tube collector is exempt from the effects consideration of wind loading for the same reason as the snow loading.
When considering flat panels wind tests have been conducted that ensure that they and their fixing brackets can withstand all recorded wind forces in Ireland when mounted on a four storey house or less.

Pipework & Liquids

- Is anti-freeze being used as the solar system fluid?
- Ensure solder joints are not used throughout the entire system
- Ensure high temperature insulation is used through all pipe work in solar system
- Ensure white paste and hemp is used on all fitting connections throughout
- Ensure Joule copper overflow & disch. vessel used to recover fluid from safety valve

Water Quality

Water sample visually inspected and no signs of contamination visible yes/no

Fire Safety

- Ensure that there is no obvious risk to fire prevention when installing the solar system.
- Ensure that all wires are not in direct connection with any un-insulated pipe work or plant that could cause a risk of burning

Legionella / Bacterial Growth

- Ensure that there is no dead legs in the existing plumbing system that could induce the growth of legionella.
- Ensure that the stats controlling the boiler and the stat controlling the immersion are set to 60 °C or above.
- Ensure that the client understands the risk of legionella and the standard procedures for reducing the risk of it forming. Also ensure that the client understands that you are there to install a solar thermal system and that you do not take any responsibility for auditing their hot water system for risk of legionella forming. That you will endeavour to minimise the risk of it forming by the work that you carry out but any existing risk should be dealt by a certified professional.

Standard Kit Components

Navitas 2.0m ²		UK Pack Comp.			IE Pack Comp.		
Code	Description	1	2	3	1	2	3
Components for Solar Kits							
SW-OR-0000002V	On Roof Panel Vert 2m	1	2	3	1	2	3
SKC-000000001	1 Panel Clamp Kit	1	-	-	1	-	-
SKC-000000002	2 Panel Clamp Kit	-	1	-	-	1	-
SKC-000000003	3 Panel Clamp Kit	-	-	1	-	-	1
SW-00000000-P1	Aluminium Profile 1m	1	-	1	1	-	1
SW-00000000-P2	Aluminium Profile 2m	-	1	1	-	1	1
SKN-C-00000ERP	Solar Controller Deltasol BS HE (ERP)	1	1	1	1	1	1
SVE-0000000024	Solar Expansion Vessel 24Ltr	1	1	1	1	1	-
SVE-0000000035	Solar Expansion Vessel 35Ltr	-	-	-	-	-	1
SVE-0000000050	Solar Expansion Vessel 50Ltr	-	-	-	-	-	-
SVS-0000000000	Solar Expansion Vessel Connect	1	1	1	-	-	-
SZ-L-0D-0ERP-5	Solar Pump Station Dual ERP 5m	1	1	1	1	1	1
SKU-0000000020	20L Pre-Mixed Solar Fluid	1	1	1	1	1	2
SVB-000000000P	Solar Discharge- Plastic	1	1	1	-	-	-
OZM-0000.75NRV	Thermo Mixing Valve 3/4" NRV	1	1	1	-	-	-
OZM-00000.75HP*	Thermo Mixing Valve 3/4" HP *	-	-	-	1	1	1
SZ-G-0G-000004	Solar Pipe Entry Gasket Set 4"	-	-	-	1	1	1
SZ-G-0G-000000	Solar Pipe Entry Flashing	1	1	1	-	-	-
SZF-3/4-3/4-MF	Solar Elbow 3/4" x 3/4" Flat Face	2	2	2	-	-	-
SZF-3/4-3/4-SM	Solar Fitting 3/4" x 3/4" nip DN16 FF	1	1	1	-	-	-

Roof Mounting Options Depending On Roof Type

SKRP-T-0000001	1 Panel Roof Mounting Kit - Tile	1	-	1	1	-	1
SKRP-T-0000002	2 Panel Roof Mounting Kit - Tile	-	1	-	-	1	-
SKRP-S-0000001	1 Panel Roof Mounting Kit - Slate	1	-	-	1	-	-
SKRP-S-0000002	2 Panel Roof Mounting Kit - Slate	-	1	-	-	1	-
SKRP-B-0000001	1 Panel Roof Mounting Kit - Bolt	-	-	-	1	-	2
SKRP-B-0000002	1 Panel Roof Mounting Kit - Bolt	-	-	-	-	1	-

Navitas 2.5m ²		UK Pack Comp.			IE Pack Comp.		
Code	Description	1	2	3	1	2	3
Components for Solar Kits							
SW-OR-00002.5V	On Roof Panel Vert 2.5m	1	2	3	1	2	3
SKC-000000001	1 Panel Clamp Kit	1	-	-	1	-	-
SKC-000000002	2 Panel Clamp Kit	-	1	-	-	1	-
SKC-000000003	3 Panel Clamp Kit	-	-	1	-	-	1
SW-00000000-P1	Aluminium Profile 1m	1	-	1	1	-	1
SW-00000000-P2	Aluminium Profile 2m	-	1	1	-	1	1
SKN-C-00000ERP	Solar Controller Deltasol BS HE (ERP)	1	1	1	1	1	1
SVE-0000000024	Solar Expansion Vessel 24Ltr	1	1	1	1	1	-
SVE-0000000035	Solar Expansion Vessel 35Ltr	-	-	-	-	-	1
SVE-0000000050	Solar Expansion Vessel 50Ltr	-	-	-	-	-	-
SVS-0000000000	Solar Expansion Vessel Connect	1	1	1	-	-	-
SZ-L-0D-0ERP-5	Solar Pump Station Dual ERP 5m	1	1	1	1	1	1
SKU-0000000020	20L Pre-Mixed Solar Fluid	1	1	1	1	1	2
SVB-000000000P	Solar Discharge- Plastic	1	1	1	-	-	-
OZM-0000.75NRV	Thermo Mixing Valve 3/4" NRV	1	1	1	-	-	-
OZM-00000.75HP*	Thermo Mixing Valve 3/4" HP *	-	-	-	1	1	1
SZ-G-0G-000004	Solar Pipe Entry Gasket Set 4"	-	-	-	1	1	1
SZ-G-0G-000000	Solar Pipe Entry Flashing	1	1	1	-	-	-
SZF-22-000-CAP	Solar 3/4" Blank Cap *	2	2	2	2	2	2
SZF-3/4-3/4-SM	Solar Fitting 3/4" x 3/4" nipple *	1	1	1	-	-	-
SW-IR-U00000	Navitas 2.5m U Bend *	-	-	-	-	-	-

* Quantities of these items will increase if the panels are ordered as horizontal system

Roof Mounting Options Depending On Roof Type

SKRP-T-0000001	1 Panel Roof Mounting Kit - Tile	1	-	1	1	-	1
SKRP-T-0000002	2 Panel Roof Mounting Kit - Tile	-	1	-	-	1	-
SKRP-S-0000001	1 Panel Roof Mounting Kit - Slate	1	-	-	1	-	-
SKRP-S-0000002	2 Panel Roof Mounting Kit - Slate	-	1	-	-	1	-
SKRP-B-0000001	1 Panel Roof Mounting Kit - Bolt	-	-	-	1	-	2
SKRP-B-0000002	1 Panel Roof Mounting Kit - Bolt	-	-	-	-	1	-

Standard Kit Components

Code	Description	UK Pack Comp.			IE Pack Comp.		
		1	2	3	1	2	3

DN16 Solar Tail Pack Standard System

SKT-00000000	DN16 Solar SS Insulated Tail 0.75m	-	-	-	1	1	1
--------------	------------------------------------	---	---	---	---	---	---

10m DN16 Solar Pipe Pack Standard System

SPD-16-10-0000	DN16 10m sol SS pipe duo ins	1	1	1	1	1	1
SZ-J-0000DN-16	solar fitting joiner pack DN16	1	1	1	1	1	1

15m DN16 Solar Pipe Pack Standard System

SPD-16-15-0000	DN16 15m sol SS pipe duo ins	1	1	1	1	1	1
SZ-J-0000DN-16	solar fitting joiner pack DN16	1	1	1	1	1	1

25m DN16 Solar Pipe Pack Standard System

SPD-16-25-0000	DN16 25m sol SS pipe duo ins	1	1	1	1	1	1
SZ-J-0000DN-16	solar fitting joiner pack DN16	1	1	1	1	1	1

* Pipe packs are not included in kit as standard. The requirement and length of these packs are the responsibility of the contractor on site to order.

Flat Roof Frames - In Place Of Mounting Kits

SK-F-000-01-25	1 Panel Flat Roof Frame 25°	-	-	-	-	-	-
SK-F-000-02-25	2 Panel Flat Roof Frame 25°	-	-	-	-	-	-

Connection Setup For Panels

For 2m² Panels (SW-OR-000002V)

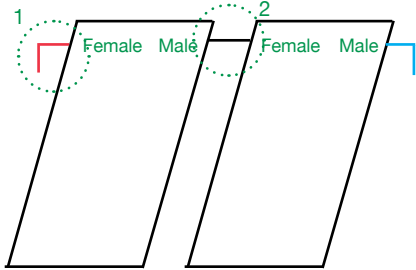

1



2



For 2.5m² Panels (SW-OR-00002.5V)

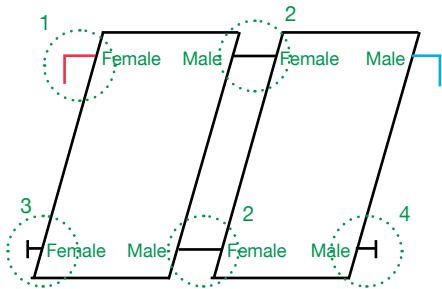

3



4



For 2.5m² Panels Horizontal (SW-OR-00002.5V)

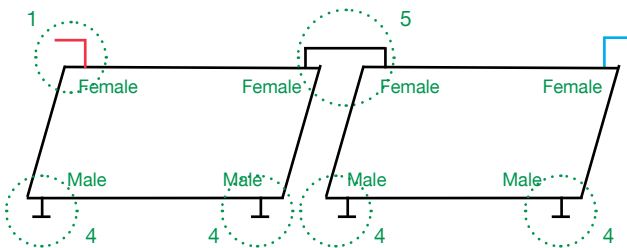

5



UK Pack Components



SW-OR-000002V
SW-OR-00002.5V



SZ-L-0D-0ERP-5



SKU-0000000020



SKN-C-00000ERP



SVB-000000000P



SVS-0000000000
SZF-3/4-3/4-SM
SZF-3/4-3/4-MF



OZM-0000.75NRV



SVE-0000000024
SVE-0000000036

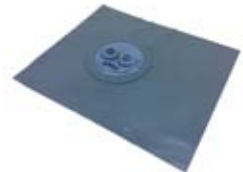

SZ-G-0G-000000



SZF-3/4-3/4-SM
SZF-3/4-3/4-MF



SZF-22-000-CAP *



SW-IR-U00000 **

* When panels are ordered as vertical system only 1 cap required

** U-bend piece only supplied when panels ordered as horizontal system

IE Pack Components



SW-OR-000002V
SW-OR-00002.5V



SZ-L-0D-0ERP-5



SKU-000000020



SKN-C-00000ERP



OZM-0000.75HP



SVE-000000024
SVE-000000036



SZ-G-0G-000004



SZF-3/4-3/4-SM



SZF-22-000-CAP *



SW-IR-U00000 **

* When panels are ordered as vertical system only 1 cap required

** U-bend piece only supplied when panels ordered as horizontal system

Mounting Bracket Options



SKRP-S-00000001
SKRP-S-00000002



SKRP-T-00000001
SKRP-T-00000002



SKRT-B-0000020
SKRT-B-0000030

Solar Pipe Components Not Included In Standard Kit



SZF3/4-3/4-TEE



SZF-22-3/4-TU0



SZ-J-0000DN-16



Code	Description
SPD-16-10-0000	DN16 10m sol SS pipe duo ins
SPD-16-15-0000	DN16 15m sol SS pipe duo ins
SPD-16-25-0000	DN16 25m sol SS pipe duo ins

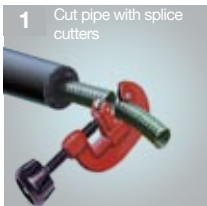

Setting Out The Roof

1 Panel Extension Flashing Kit

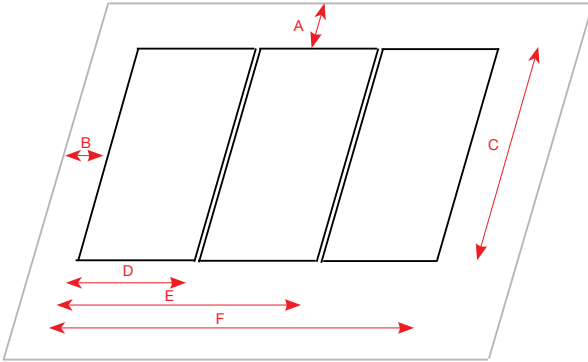

Code	Dims 2.0m ²	Dims 2.5m ²
A	300mm	300mm
B	300mm	300mm
C	1,730mm	2,150mm
D	1,070mm	1,070mm
E	2,440mm	2,440mm
F	3,590mm	3,590mm

Mounting Orientations

2.0m ²	2.5m ²
-------------------	-------------------

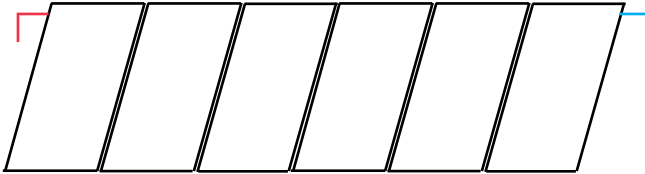

Maximum 6 flat panels vertically mounted



Flat panels horizontally mounted

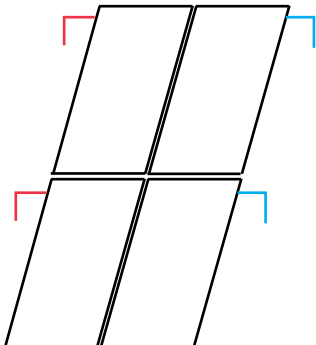

Flat panels mounted above each other



Roof Mounting Instructions

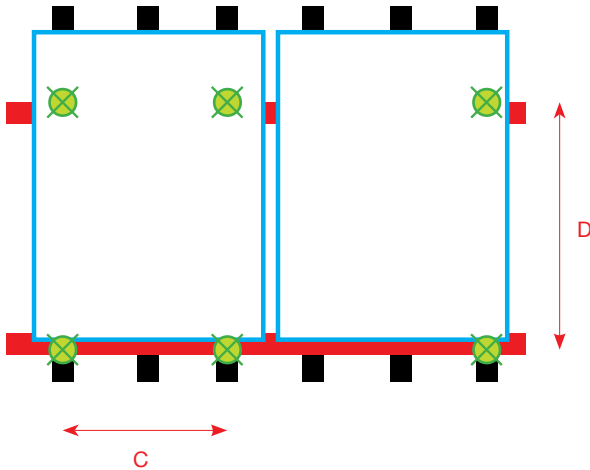
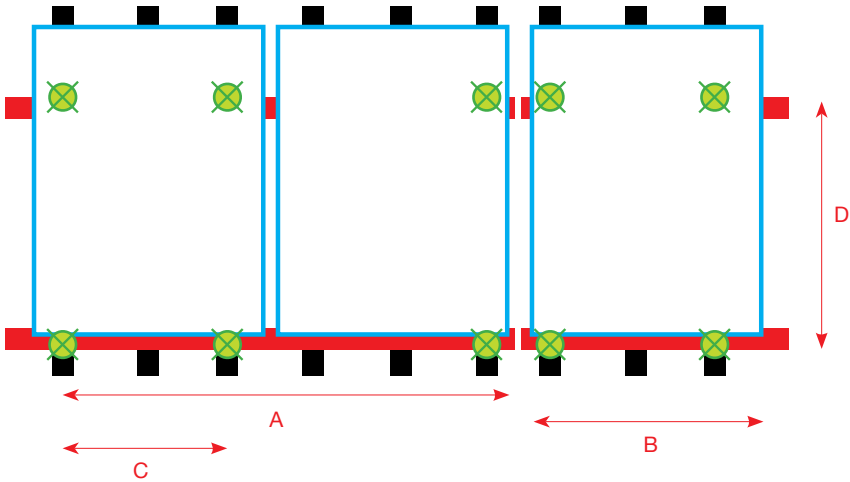

Legend	
A	2 panel
B	1 panel
C	Distance between fixings
D	Distance between profiles

	Distance Between Roof Fixings	
	2.0m ² & 2.5m ²	
	Min	Max
1 Panel	200	400
2 Panel	200	600

	Distance Between Horizontal Profiles	
	Min	Max
2.0m ²	1,200	1,700
2.5m ²	1,200	2,000

Sloped Roof - Bolt Mounting Kit

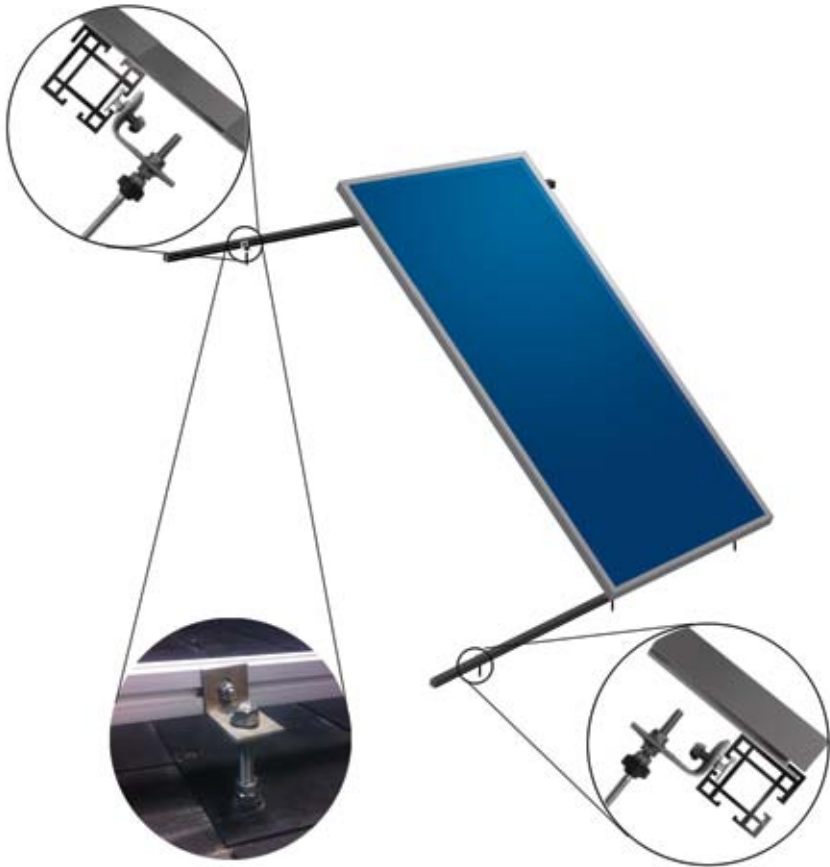

Roof fixing bolts are drilled down through the slate or tile covering the roof. The rubber gasket on the bolt keeps the penetration point in the roof weather proofed. The bolt is connected to the profile by use of a stainless steel L plate and nuts, bolts and washers. The bolt head slides through the profile to the desired location and the L bracket to fixed using the nut and washer.

Sloped Roof - Tile Mounting Kit

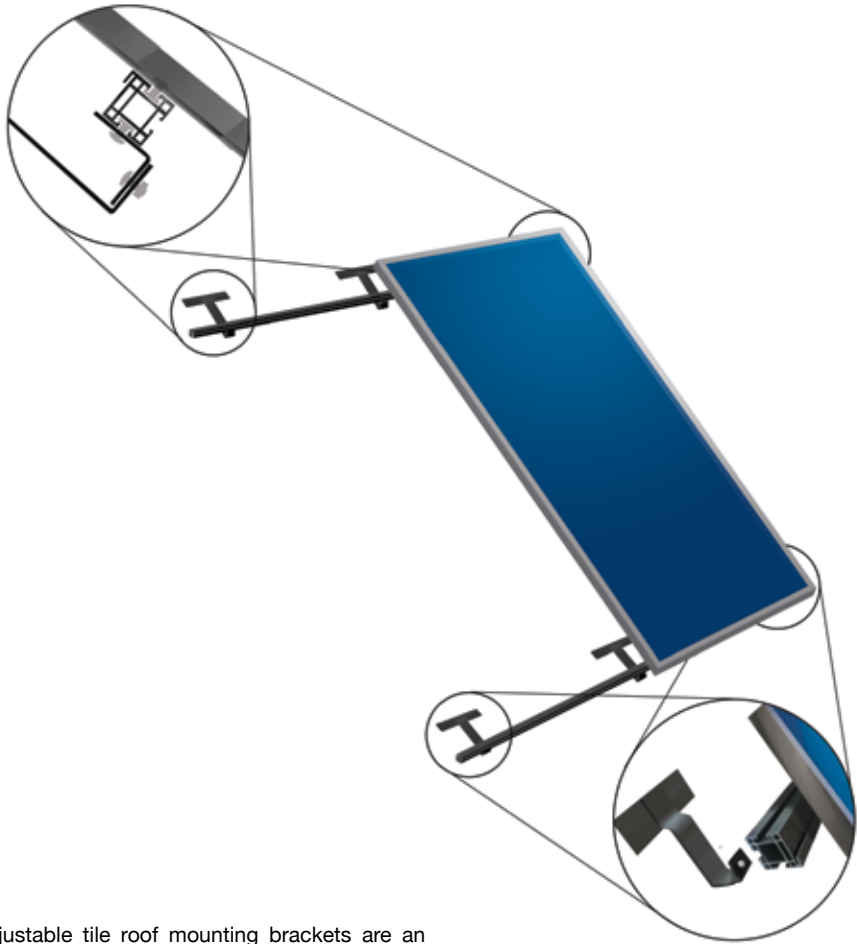

Adjustable tile roof mounting brackets are an ideal solution when fixing a solar collector to a thick roof tile. The top piece can adjust to increase or decrease the height of the collector above the roof tile. The bracket is connected to the profile using nuts, bolts and washers. The bolt head slides through the profile to the desired location and then the bracket is fixed using the nut and washer.

Flat Roof - Mounting Kit



The flat roof frame creates a pitch of 25°C from a horizontal base. The frame is manufactured from 30x30mm angle aluminium. The frame consists of triangular A frame setup with horizontal support bars fixed behind. Each A frame connects to the collector profiles using nuts, bolts and washers. The frame is fixed to surface by installer. Preferred method for fixing to flat surface is dependent on type of surface and available supports.

Sloped Roof - Slate Mounting Kit

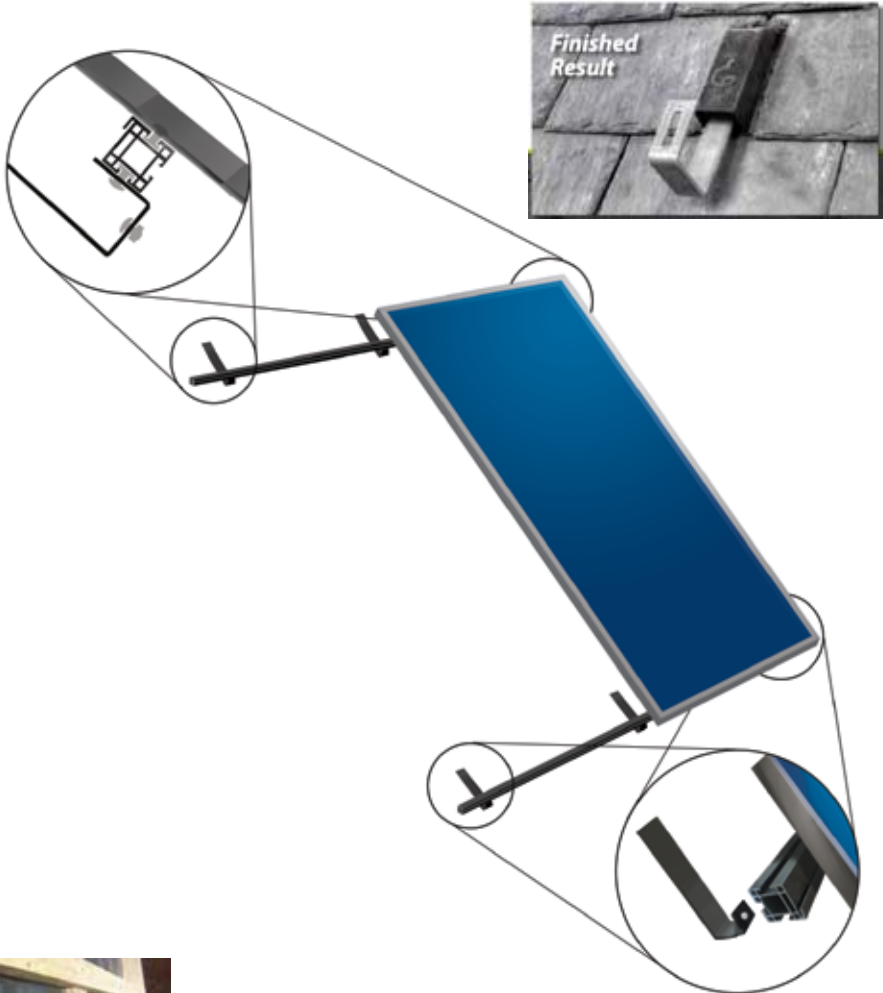

30mm clearance

The elbow of the bracket must give at least 30mm clearance from the rafter to bend down the roof i.e the elbow should be no less than 30mm deep and then can be made to work with shims (packing). Brackets with clearance of 40/45mm from the rafter probably won't need shims.

Shims (packaging) are used to lift the roof anchor/bracket away from the slate underneath the bracket.

Any contact between the flashing and the roof anchor/bracket could cause a problem.

Once the roof is opened and the rafter located, the position of the roof anchor/bracket is now determined.

The position of A, B and C are the only places that the rafter can land in relation to the slate.

A Rafter lands where the 2 slates join on the rafter

B Rafter lands in the middle of the slate

C Rafter lands somewhere between the middle & the edge of a slate

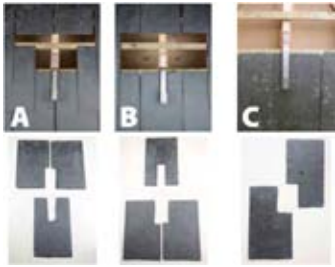
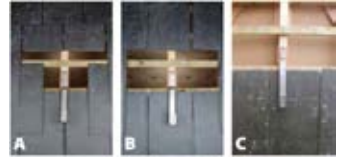

When installing on an existing roof, the bottom slates do not need to be removed and can be cut in-situ with an angle grinder.

Note: One cut below the roof anchor/bracket means two cuts above the flashings (A) and vice versa (B)

Note: Position C could fall either side of the centre and only needs two cuts, one under and one over the roof anchor/bracket.

Step 1: Fix foam to the bracket drop

Step 2: As a guide, slates sizes are marked on the solar flash

Step 3: Solar flash can be trimmed or nailed through. If nailing through, ensure relevant line for slate size centres on the batten. Apply pressure to hold Solarflash solid when nailing through.

Step 4: Cut slates around the hood of the Solar flash as shown in the previous diagram.

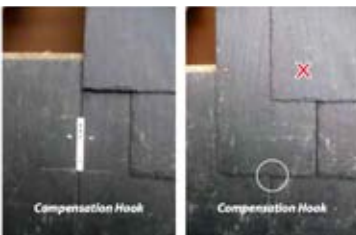

The compression hook is used where it is not possible to access both nail holes and prevents the head of the slate tilting off the batten.

Unable to access nail hole under this slate

Step 1: Mark position of the bottom of the object slate and fix comp hook to this line

Step 2: Slide the slate into position on the comp hook and nail the accessible hole. Slate cannot tilt.

Step 1: Position the hallhook between the slates. Use the nail hole that positions the bottom hook at least 10mm up from the finished slate line. The hallhook will stretch up to 40mm. Hang the hookpull on the hallhook as per illustration.

Step 2: Slide the object slate into position then using the hookpull, pull firmly until the hallhook locates the base of the object slate. Remove the hookpull.

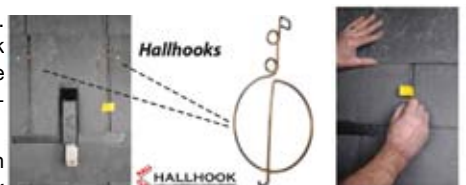

Finishing Roof Work

Inserting Probe Into The Panel

Inside the controller box you will find 3 probes as shown in the diagram.

Take the black probe from the box and insert this black probe into the sensor pocket located on the left hand side of the far left panel.

This side is now the hot side of the solar system.

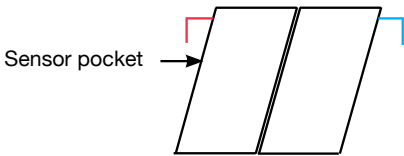

Connecting Solar Pipe To The Panels

If you choose to use solar pipe either in full lengths or as tails the connections must be made to the panels prior to fitting the flashing kit.

The panels are terminated in 3/4" BSP flat face male nipple as supplied as part of the kit. Following the diagram below single fitting should be tightened to the flat face of the elbow connected to the panel.

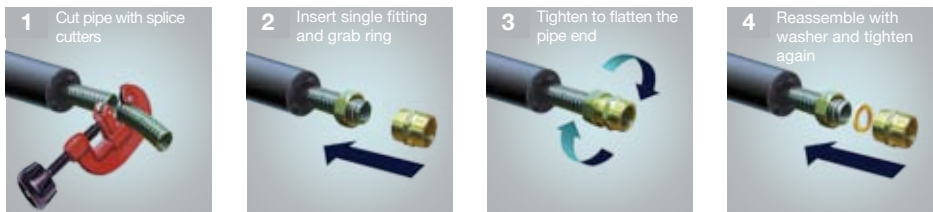

Connecting Panels Together

The Acapella collector has a 3/4" flat face male thread on one side and a swivel nut 3/4" female on the other side. This means that each panel connects directly to the panel beside it. A fibre washer must be inserted between the flat face of the male thread and the internal of the female swivel nut.

Insulation.



Single Orientation Single Cylinder

Under Roof Remaining Work

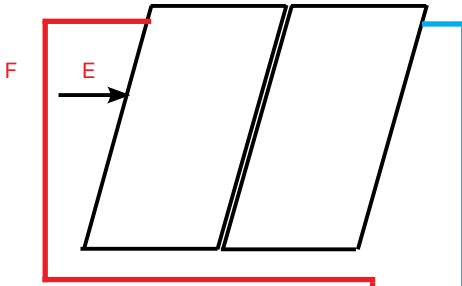

- A Anti gravity loop. Stops backward movement of heat from cylinder to panel when panels are cold.
- B Return pipework from solar coil to pump station. Return pipework always connects to pump side of pump station
- C Discharge container required to catch discharge from solar system in the event of over pressurisation. This must not be connected to drain.
- D Solar expansion vessel to be mounted with connection facing upwards. Always to be mounted below the pump station.

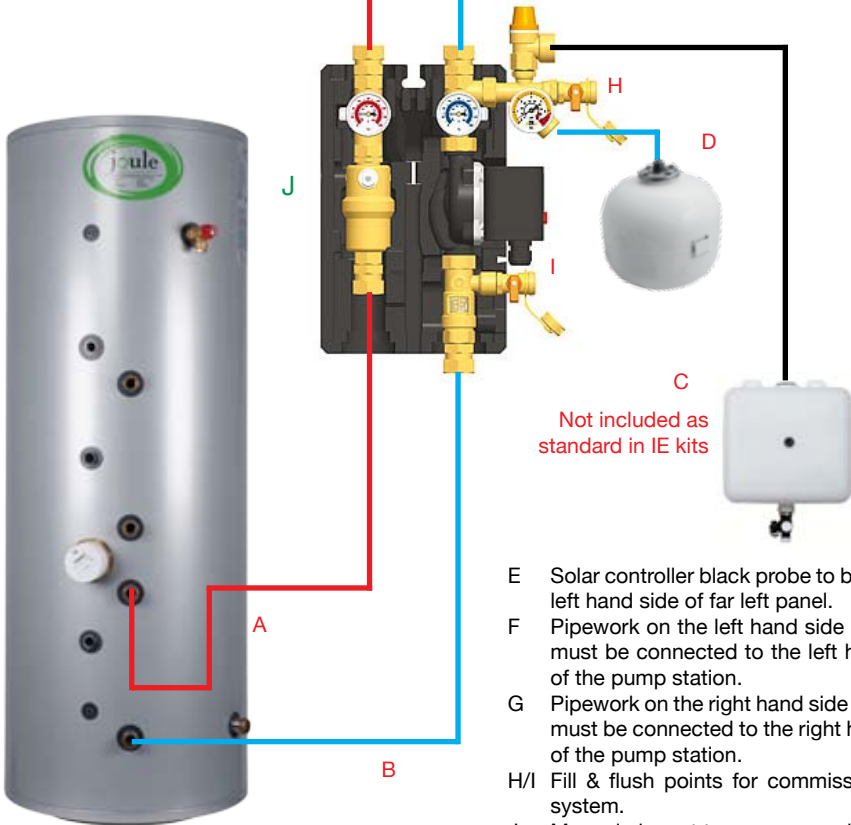

Not included as standard in IE kits

- E Solar controller black probe to be fitted in left hand side of far left panel.
- F Pipework on the left hand side of panels must be connected to the left hand side of the pump station.
- G Pipework on the right hand side of panels must be connected to the right hand side of the pump station.
- H/I Fill & flush points for commissioning of system.
- J Manual air vent to remove small pockets of air after commissioning.

Wiring The System



Do not crosswire the power cable with the comms cable on the solar pump. If you do this you will see a flashing green light on the pump.

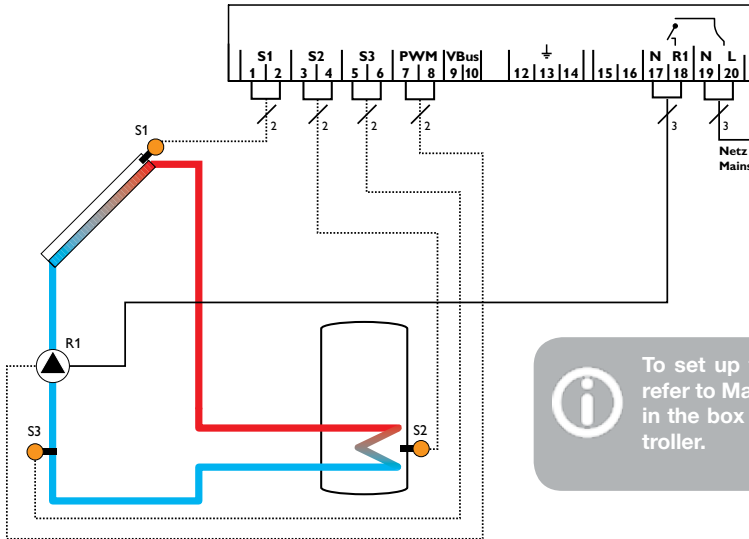

To set up the controller refer to Manual supplied in the box with the controller.

The controller calculates the temperature difference between collector sensor S1 and store sensor S2. If the difference is larger than or identical to the adjusted switch-on temperature difference (DT O), the solar pump will be activated by the relay, and the store will be loaded until the switch-off temperature difference (DT F) or the maximum store temperature (S MX) is reached. Unlike the diagram above we recommend that S3 is inserted to the top cylinder sensor pocket.

Commissioning

It is important that a motorised flush and fill centre is used to fill and pressurise the system with solar fluid as follows:

- Connect fill hose to H and connect flush hose to I.
- Close the isolating valve above to the flow meter to ensure all air and liquid passes through the fill centre to filter any air and contaminants.
- Allow the flush pump to run for 1 minute. Close I and pressure the solar system to 4bar. Close H once this is reached. Shut off solar fill pump.
- Allow system to stand at 4bar pressure to make sure there is no leaks.
- After this process is completed without any leaks being present open I and H and allow the flush pump to run.
- While flush pump is running slightly open connections on expansion vessel, pump station and coil. This will allow any air trapped locally to exit the system more easily.
- After this has been completed allow flush pump to run for a further 15 minutes.
- Once you are confident there is no more air in the system (you will be able to see air in the system through the flow meter and also the noise it makes), close I first.
- Allow the system to re-pressurise to 2bar. Once achieved, close H and shut off flush pump.
- Do not turn on the power supply to the solar controller.

Dual Orientation Single Cylinder

Under Roof Remaining Work

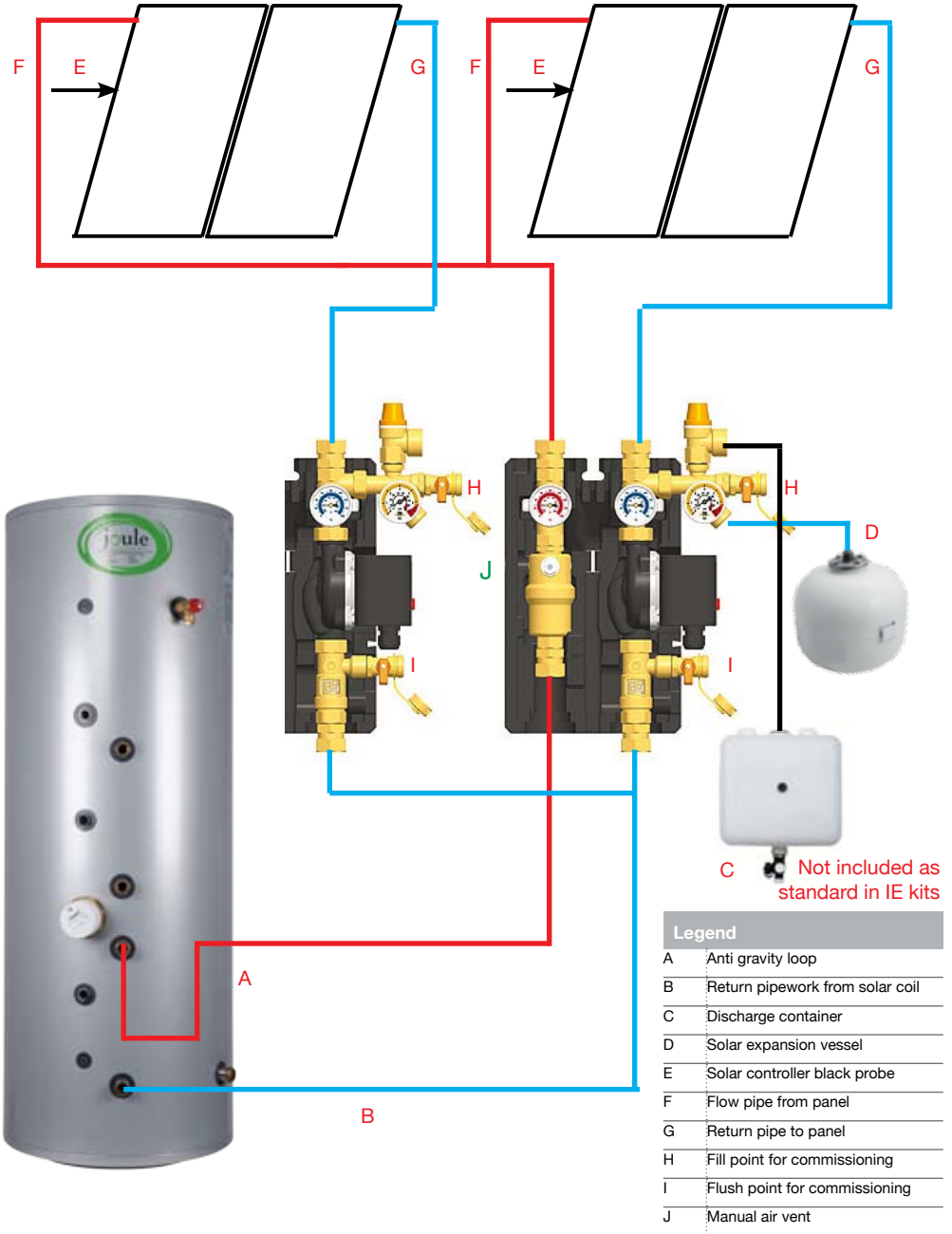

Wiring The System



Do not crosswire the power cable with the comms cable on the solar pump. If you do this you will see a flashing green light on the pump.

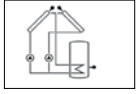
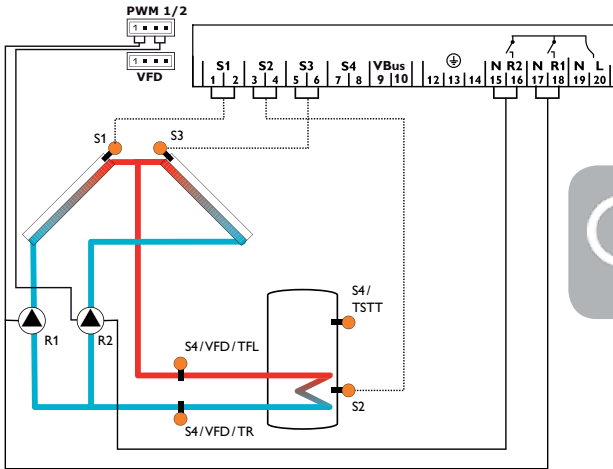

To set up the controller refer to Manual supplied in the box with the controller.

The controller calculates the temperature difference between collector sensors S1 and S3 and store sensor S2. If the differences are larger than or identical to the adjusted switch-on temperature difference (DT O), one or both solar pumps will be activated by relay 1 and / or relay 2, and the store will be loaded until the switch-off temperature difference (DT F) or the maximum store temperature (SMX) is reached. Sensor S4 can optionally be used as the reference sensor for the store emergency shutdown option (OSEM). If heat quantity measurement (OHQM) is activated, S4 and VFD are used as the flow and return sensors respectively.

Commissioning

It is important that a motorised flush and fill centre is used to fill and pressurise the system with solar fluid as follows:

- On dual line pump station connect fill hose to H and connect flush hose to I.
- Close the isolating valve above to the flow meter to ensure all air and liquid passes through the fill centre to filter any air and contaminants.
- Allow the flush pump to run for 1 minute. Close I and pressure the solar system to 4bar. Close H once this is reached. Shut off solar fill pump.
- Allow system to stand at 4bar pressure to make sure there is no leaks.
- After this process is completed without any leaks being present open I and H and allow the flush pump to run.
- While flush pump is running slightly open connections on expansion vessel, pump station and coil. This will allow any air trapped locally to exit the system more easily.
- After this has been completed allow flush pump to run for a further 15 minutes.
- Once this was complete move the fill&flush hoses to the single line pump station and repeat.
- Once you are confident there is no more air in the system (you will be able to see air in the system through the flow meter and also the noise it makes), close I first.
- Allow the system to re-pressurise to 2bar. Once achieved, close H and shut off flush pump.
- Do not turn on the power supply to the solar controller.

Single Orientation Dual Cylinder

Under Roof Remaining Work

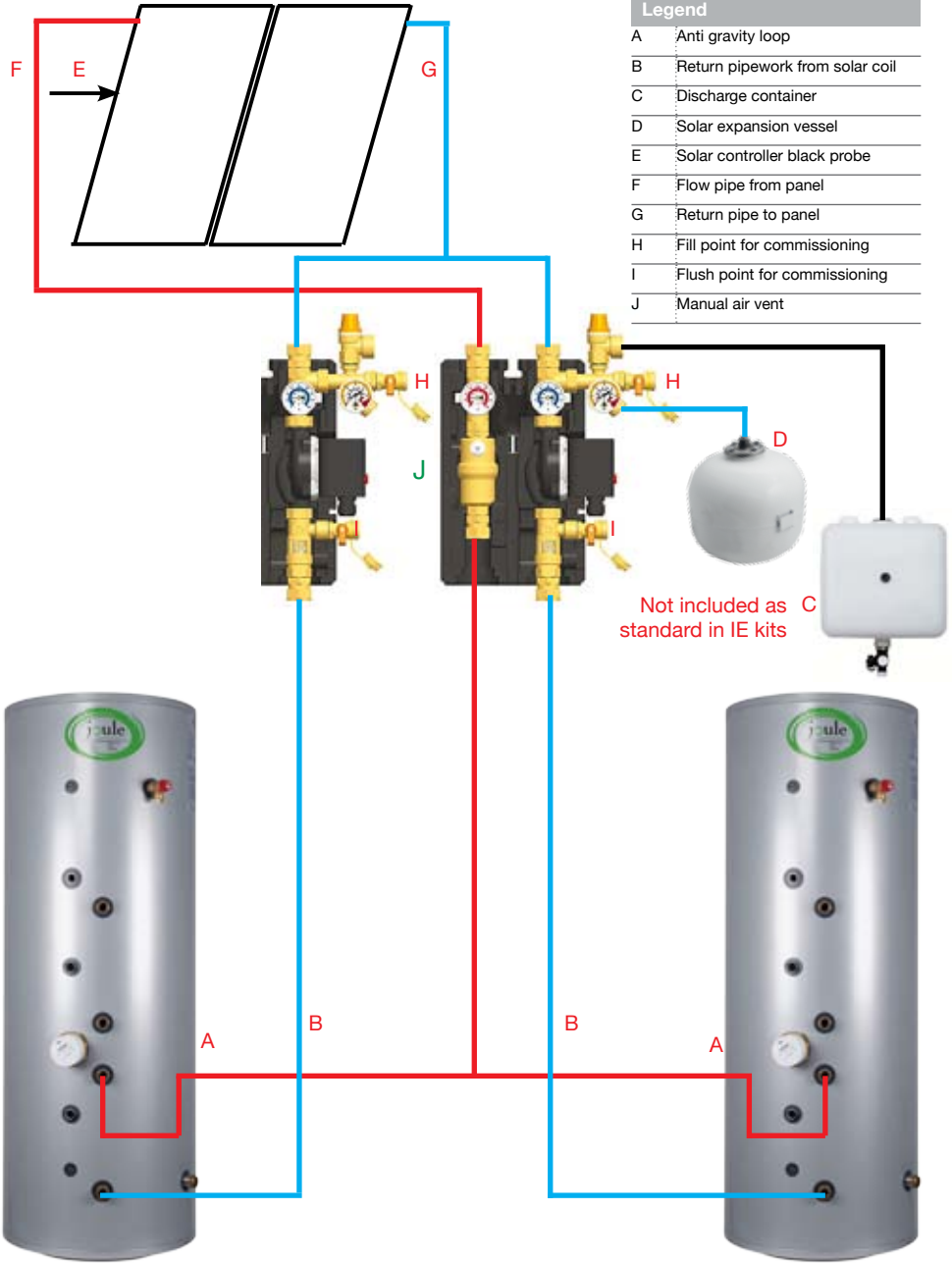

Legend	
A	Anti gravity loop
B	Return pipework from solar coil
C	Discharge container
D	Solar expansion vessel
E	Solar controller black probe
F	Flow pipe from panel
G	Return pipe to panel
H	Fill point for commissioning
I	Flush point for commissioning
J	Manual air vent

Not included as standard in IE kits

Wiring The System



Do not crosswire the power cable with the comms cable on the solar pump. If you do this you will see a flashing green light on the pump.

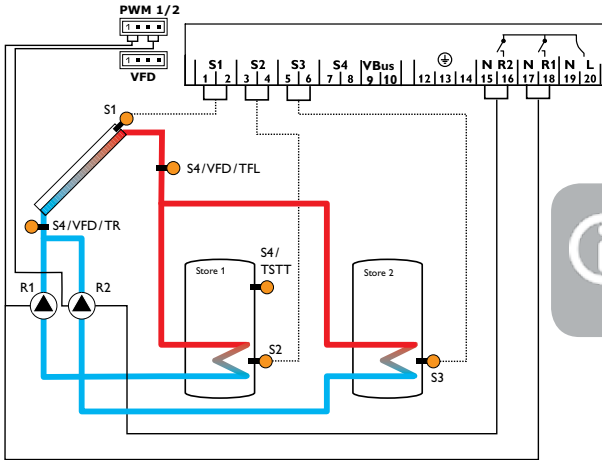

To set up the controller refer to Manual supplied in the box with the controller.

The controller calculates the temperature difference between collector sensor S1 and store sensors S2 and S3. If the difference is larger than or identical to the corresponding adjusted switch-on temperature differences (DT1O / DT2O), one or both solar pumps will be activated by relay 1 and/or relay 2, and the corresponding store will be loaded until the switch-off temperature difference (DT1F/DT2F) or the maximum store temperature (S1MX/S2MX) is reached. The priority logic causes priority loading of the store selected in the PRIO channel, if possible. If PRIO = 0, both stores will be loaded simultaneously. Sensor S4 can optionally be used as the reference sensor for the store emergency shutdown option (OSEM). If heat quantity measurement (OHQM) is activated, S4 and VFD are used as the flow and return sensors respectively.

Commissioning

It is important that a motorised flush and fill centre is used to fill and pressurise the system with solar fluid as follows:

- On dual line pump station connect fill hose to H and connect flush hose to I.
- Close the isolating valve above to the flow meter to ensure all air and liquid passes through the fill centre to filter any air and contaminants.
- Allow the flush pump to run for 1 minute. Close I and pressure the solar system to 4bar. Close H once this is reached. Shut off solar fill pump.
- Allow system to stand at 4bar pressure to make sure there is no leaks.
- After this process is completed without any leaks being present open I and H and allow the flush pump to run.
- While flush pump is running slightly open connections on expansion vessel, pump station and coil. This will allow any air trapped locally to exit the system more easily.
- After this has been completed allow flush pump to run for a further 15 minutes.
- Once this was complete move the fill&flush hoses to the single line pump station and repeat.
- Once you are confident there is no more air in the system (you will be able to see air in the system through the flow meter and also the noise it makes), close I first.
- Allow the system to re-pressurise to 2bar. Once achieved, close H and shut off flush pump.
- Do not turn on the power supply to the solar controller.

Service Record

It is recommended that your hot water system is serviced regularly and that the appropriate Service Record's completed.

Service Provider

Before completing the appropriate Service Record below, please ensure you have carried out the service as described in the manufacturer's instructions.

Service 1 Date

Engineer Name

Company Name

Telephone No

Comments

.....

.....

Signature

Service 1 Date

Engineer Name

Company Name

Telephone No

Comments

.....

.....

Signature

Service 1 Date

Engineer Name

Company Name

Telephone No

Comments

.....

.....

Signature

Service 1 Date

Engineer Name

Company Name

Telephone No

Comments

.....

.....

Signature

Service 1 Date

Engineer Name

Company Name

Telephone No

Comments

.....

.....

Signature

Service 1 Date

Engineer Name

Company Name

Telephone No

Comments

.....

.....

Signature

Service 1 Date

Engineer Name

Company Name

Telephone No

Comments

.....

.....

Signature

Service 1 Date

Engineer Name

Company Name

Telephone No

Comments

.....

.....

Signature

Service 1 Date

Engineer Name

Company Name

Telephone No

Comments

.....

.....

Signature

Service 1 Date

Engineer Name

Company Name

Telephone No

Comments

.....

.....

Signature

JOULE IE

mail Kylemore Park West, Ballyfermot, Dublin 10
tel +353 (1) 623 7080
fax +353 (1) 626 9337
eml info@joule.ie
web www.joule.ie

JOULE PL

mail 23-200 Kraśnik, ul. Towarowa 34.
tel +48 (0) 128811171
fax +48 (0) 814709046
eml biuro@joule-pl.pl
web www.joule-pl.pl

JOULE UK

mail Unit 17C&D Power Road, Plantation Bus. Pk.
Bromborough, Wirral, CH62 3RN
tel +44 (0) 1513 551 094
fax +44 (0) 1513 568 336
eml info@jouleuk.co.uk
web www.jouleuk.co.uk