

KLINGER SCIENTIFIC

Bringing You Science Since 1955

Thermoelectric Effects Apparatus KSCITHEA

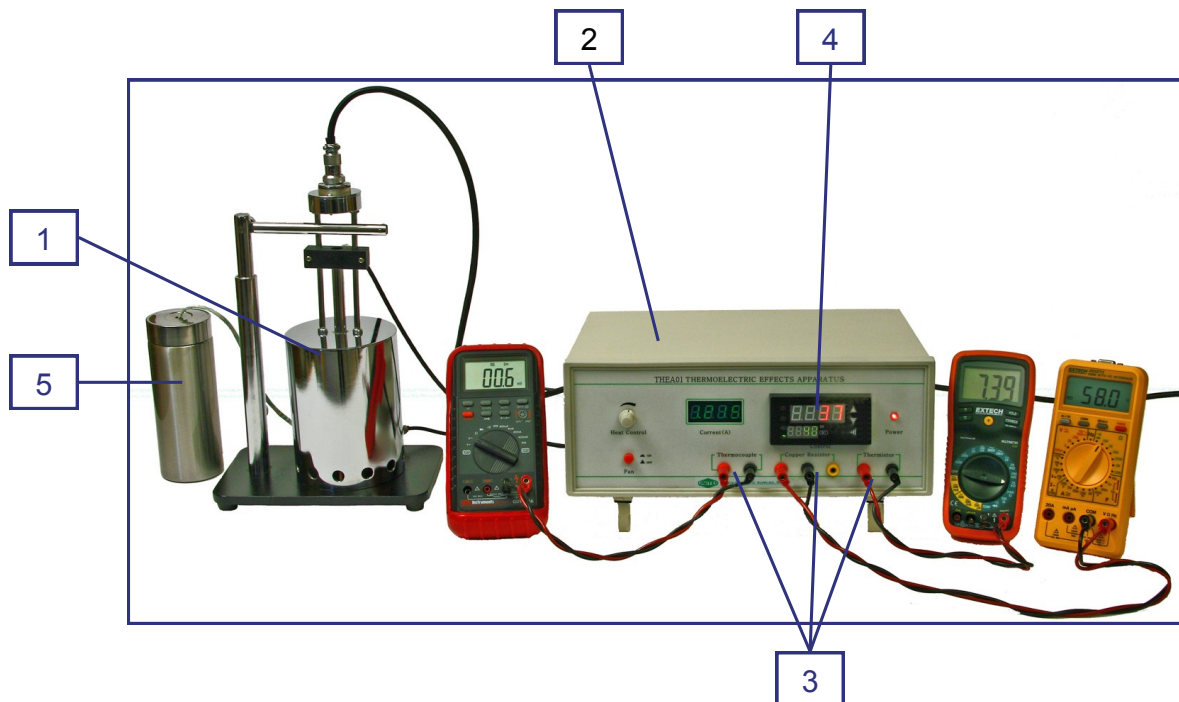

Figure 1

DESCRIPTION

The Thermolectric Effects Apparatus is an educational device that allows students to investigate the thermal characteristics of three commonly-used electrical thermometry devices and also to learn the features and behavior of a closed loop digital temperature control system.

The apparatus consists of an oven (1, *Figure 1*) containing a cooling fan, a massive metal block with an electric heater, the three samples, and the control system sensor, and a control unit (2) that provides the heating current, connectors to the three sample devices (3) and the digital temperature controller (4). The oven and the control unit are connected by three multi-pole cables.

The sample devices are a thermocouple, a three-pole metal resistor, and a thermistor. An insulated flask (5) is provided to hold ice water for the cold junction of the thermocouple. The signals from the three sample devices can be read by any suitable measuring device provided by the user (digital multimeters are shown in *Figure 1* as an example.)

The digital control system can be operated in P, PI, PD, and PID modes to show their characteristics, and a wide range of parameters can be set. A detailed description follows.

SPECIFICATIONS

The Oven and Sample System

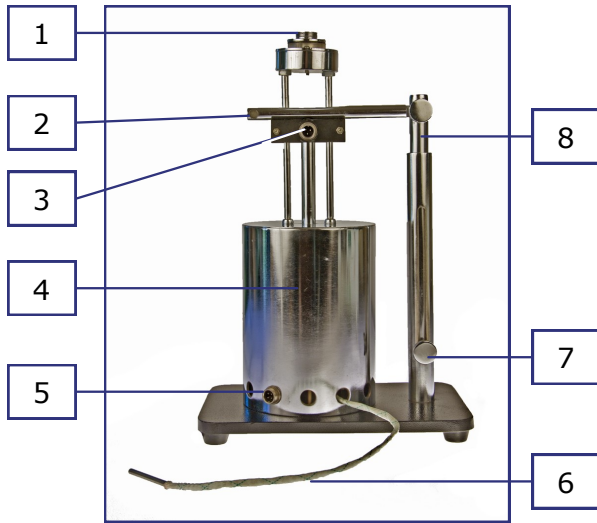

Figure 2

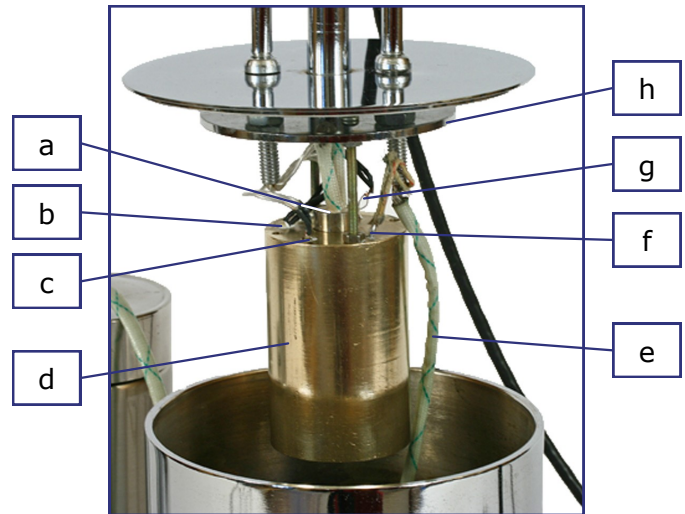

Figure 3

The heating block with the samples is supported from the top cover of the oven on two thin struts. The assembly can be raised out of the oven on a telescoping support rod. *Figures 2 and 3* identify the oven and sample heating block components:

The Oven—*Figure 2* (rear view)

1. Top multi-pole socket(10 poles)
2. Horizontal support rod clamp screw
3. Center multi-pole socket (3 poles)
4. Oven casing
5. Lower multi-pole socket (4 poles)
6. Thermocouple cold junction & lead
7. Locking screw for support rod
8. Telescoping support rod

The Sample Heating Assembly—*Figure 3*

- a. Electric heater cartridge
- b. Resistor
- c. Thermistor
- d. Sample heating block
- e. Thermocouple cold junction lead
- f. Thermocouple hot junction
- g. Control system sensor
- h. Support plate & radiation shield

Thermocouple: Type K (chromel/alumel, approx. $41\mu\text{V}/^\circ\text{C}$)

Resistor: Three-pole connection, approx. 50Ω and 100Ω at 0°C , (PT100 +PT50).

Thermistor: $12\text{k}\Omega$ NTC element. Approximate curve: $\ln R (\Omega) = 3655/T (K) + \text{constant}$

Connectors: Top socket: Sample leads and controller sensor

Center socket: Heater cartridge

Lower socket: Cooling fan

Dimensions: Brass heating block: 40 mm diameter, 67 mm high

Oven: 37 cm high, 14 cm wide, 22 cm deep

Weight: 5.1 kg.

The Control Unit

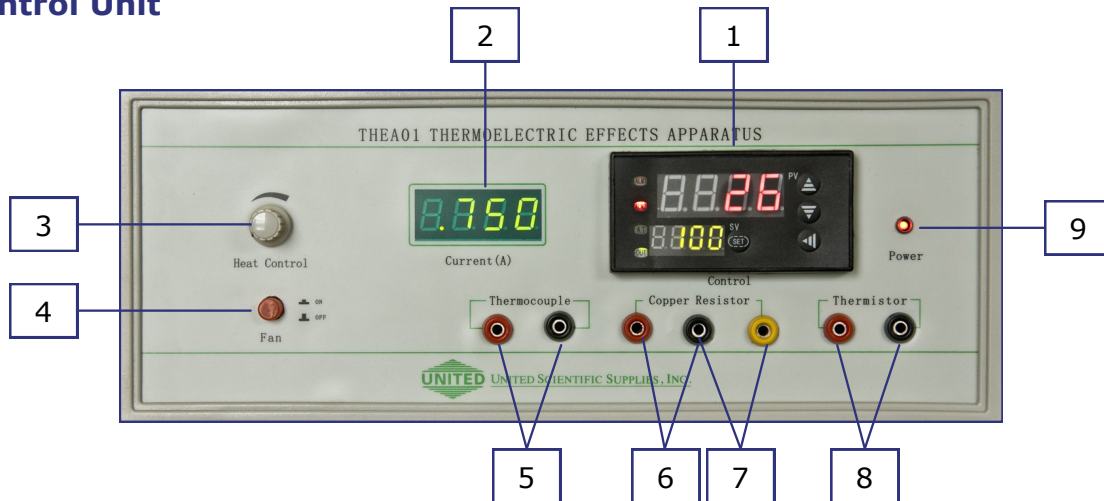

Figure 4

Figure 4 shows the front panel of the control unit:

- | | | | |
|----|---|----|------------------------------------|
| 1. | Temperature controller panel
(see below for details) | 5. | Thermocouple sample output sockets |
| 2. | Heating current display | 6. | 50Ω Pt resistor output sockets |
| 3. | Heating current adjustment knob | 7. | 100Ω Pt resistor output sockets |
| 4. | Cooling fan on/off switch | 8. | Thermistor sample output sockets |
| | | 9. | Power indicator lamp |

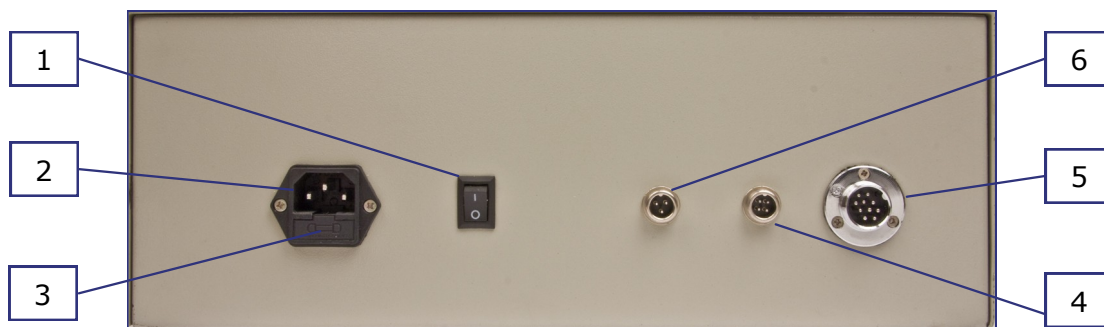

Figure 5

Figure 5 shows the rear panel of the control unit:

- | | | | |
|----|---------------------|----|-------------------------------------|
| 1. | Power on/off switch | 4. | 4-pole socket for cooling fan cable |
| 2. | Power cord socket | 5. | 10-pole socket for sample cable |
| 3. | Fuse | 6. | 3-pole socket for heater cable |



Figure 6

Figure 6 shows the temperature controller panel detail:

- | | |
|--|--|
| 1. Process Value (PV -temperature) display | 6. Set Value (SV -temperature) display |
| 2. Upper temperature limit alarm | 7. Set & menu activation button |
| 3. Lower temperature limit alarm | 8. Next option button |
| 4. Automatic mode indicator | 9. Decrease value button |
| 5. Heater output ON signal | 10. Increase value button |

Heater supply:	Regulated voltage source: 0–36V d.c. 10-turn potentiometer control Digital current display, 0.000–1.999A
Cooling fan:	12V d.c. 0.14A On/off switch control
Digital controller:	Configurable for P, PI, PD, or PID mode Process value (PV) range: 0–400°C (factory default—settable) Set value (SV) range: same as PV range PV temperature display: 4-digit, resolution 1°C or 0.1°C SV temperature display: 4-digit, resolution matches PV 24 settable parameters (see table below) 2 parameters determined by apparatus configuration
Power input:	110VAC/60Hz, 65W
Fuse:	Miniature type, 5 x 20 mm, F1.5A,250V
Dimensions:	13 cm high, 35 cm wide, 31 cm deep
Weight:	5.2 kg.

SETUP

The Oven and Sample System

- **CAUTION!** Avoid touching the samples or the control sensor in their wells in the heating block. They are inserted with thermal conduction paste to ensure good thermal contact with the heating block and are connected by delicate wires that are easily damaged or short circuited.

- Loosen the horizontal support rod clamp (2, *Figure 2*) and the support rod locking screw (7, *Figure 2*). Carefully seat the oven cover on the top of the oven wall with the black crosspiece on the support rods flush with the underside of the horizontal support rod. Re-tighten the two screws.
- When using the cooling fan, the oven cover may be raised a few millimeters to vent the fan's exhaust air and improve the airflow around the heating block.
- Connect the three supplied multi-pole cables to the appropriate sockets on the oven unit (1, 3, & 5, *Figure 2*), making sure that the grooves on the connectors align with the ridges on the sockets (see example, *Figure 7*):

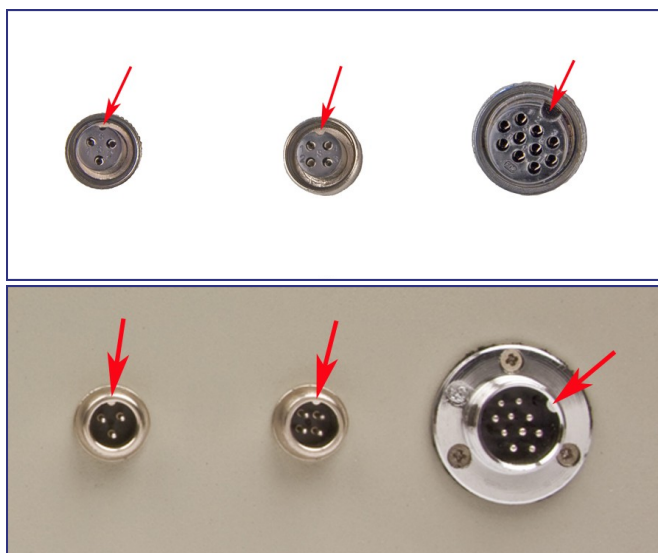

Figure 7

- Fill the insulated flask (5, *Figure 1*) with a mixture of crushed ice and water, position it close to the oven, and insert the cold junction of the thermocouple (6, *Figure 2*) through the hole in the flask lid and into the ice water. Make sure the metal-encapsulated junction is fully immersed. The flask will retain ice water for up to approximately three hours, depending on the ambient temperature of the lab.

The Control Unit

- Position the control unit close to the oven and connect the free ends of the multi-pole cables from the oven to the appropriate sockets on the rear panel of the control unit (4, 5 & 6, *Figure 5*), being careful to observe the correct orientation as before.
- Connect the power cord to the socket on the rear of the control unit (2, *Figure 5*), then to a 110VAC/60Hz outlet.
- Switch on the control unit at the rear panel (1, *Figure 5*). The controller should display "Inp" then "120" or "120.0" to indicate the maximum allowed PV and SV programmed into the controller. After a few seconds, the displays will change to indicate the current PV and SV.
- **NOTE:** The maximum allowed PV&SV can be adjusted via the controller menus (see below). The factory default maximum is 400°C. However, the maximum for this apparatus **should not be set to more than 120°C** to avoid irreversible damage to the thermistor sample.

OPERATION

General

The THEA01 Thermoelectric Effects Apparatus is designed for two types of investigation:

- Investigating the thermal characteristics and measuring techniques for three devices commonly used for industrial and technical thermometry;
- Investigating the configuration, adjustment, and behavior of a closed-loop digital controller operating a simple load with a slow response.

The controller is set up for simple operation by electrical heating and natural cooling, and can be used for precise and relatively rapid temperature control by simply resetting the set value (SV) for the desired temperature and waiting for the process value (PV) to stabilize when investigating the thermal characteristics of the samples.

The controller also allows a wide range of configurations to be easily programmed, permitting the effects of the various configurations on the control behavior to be investigated.

The Samples

Thermocouple

The K-type thermocouple (chromel-alumel*) generates approximately 4mV for a temperature difference of 100°C between the hot and cold junctions. Measurement of the output between room temperature and 100°C can conveniently be made using a DMM with a resolution of 0.01mV or an appropriate datalogger. The temperature of the ice water should be measured before and after the experiment using independent means (thermometer or temperature probe).

Platinum Resistor

The platinum resistor consists of two separate resistors of different values, connected in series, with three connections brought out to the control unit (*Figure 8*):

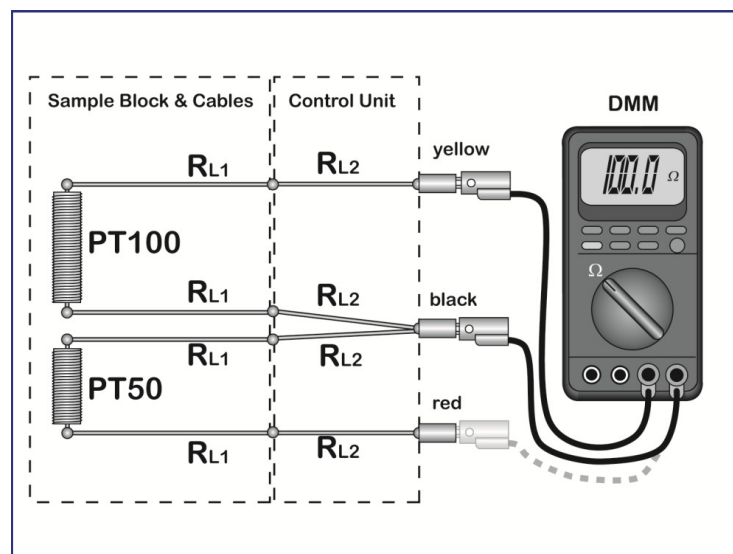

Figure 8

*Chromel = Ni 90%, Cr 10%; Alumel = Ni 95%, Mn 2%, Al 2%, Si 1%

The two resistors are a "PT100" (100Ω at 0°C) and a "PT50" (50Ω at 0°C). Each is connected through the multi-pole cable and the control unit to the front measuring sockets, where one lead of each of the resistors is connected to the central black socket. This makes a 3-wire resistor configuration. All of the four leads from the resistors through the multi-pole cable are identical and can be assumed to have identical resistances, R_{L1} , which will vary with the temperature gradient but always remain equal. Similarly, the resistances of the four identical leads inside the control unit will be equal, at R_{L2} .

The measured resistance between the red and black sockets will be:

$$R_{rb} = PT50 + 2R_{L1} + 2R_{L2} + R_M$$

where R_M is the resistance of the DMM leads.

Similarly, the measured resistance between the black and yellow sockets will be:

$$R_{by} = PT100 + 2R_{L1} + 2R_{L2} + R_M$$

It follows that

$$R_{by} - R_{rb} = PT100 - PT50$$

which is equivalent to PT50, and the effect of the leads with their unknown temperature gradient is eliminated.

The resistances R_{by} and R_{rb} can be conveniently measured by a DMM (or, preferably, two identical DMMs). Alternatively, a more precise measurement can be made using traditional bridge methods.

Thermistor

The thermistor is an NTC resistor with a resistance of about 12kΩ at 25°C (the usual reference temperature for specifying thermistors) and about 1kΩ at 100°C. The resistance can conveniently be measured using a DMM or an appropriate datalogger.

The resistance characteristic of an NTC thermistor can be described by the *B Parameter Equation*:

$$1/T = 1/T_0 + (1/B)\ln(R/R_0)$$

where T is the temperature in Kelvins, R is the resistance in Ohms, R_0 is the resistance at the reference temperature T_0 , usually 25°C (298.12K), and B is a constant that characterizes the particular thermistor. To estimate B from temperature and resistance measurements, it is convenient to rewrite the equation as

$$\ln R = B/T + \ln r_x$$

where $r_x = R_0 e^{-B/T_0}$. This allows B to be estimated from the slope of the linear relation between $\ln R$ and $1/T$.

The Heater and Controller

The Heater

- The heater cartridge in the heating block is powered by a highly stabilized voltage source in the control unit. The output voltage is set by a 10-turn potentiometer (3, *Figure 4*), and the resulting heating current is displayed on the control unit front panel (2, *Figure 4*).
- Make sure the potentiometer is set at mid-range or below (counter-clockwise) when turning the control unit on.

- The maximum heating current is 2A. As the heater cartridge warms up, its resistance increases and the current decreases by a few percent. If a constant heating current is required, it is necessary to monitor the current display during the warm up and adjust the potentiometer until a stable reading is obtained.
- Note that if you are using a heating current close to 2A, when the controller cycles the current on after an off period, the initial current will exceed 2A. The display will show a "1" and three blank digits. The apparatus is constructed to tolerate this small excess current, which will soon return to the set value. However, do not set the current far above 2A.

The Cooling Fan

- The cooling fan is independent of the control system and is switched on and off manually with a button on the control unit front panel (4, Figure 4).
- The cooling fan can be used to speed up the cooling of the heating block, and hence the reaction time of the controlled system, when the controller has switched off the heating current. Correspondingly, it also slows the heating of the block when the current is on.
- As mentioned above, the oven cover may be raised a few millimeters when using the cooling fan to provide a vent for the fan air and improve the cooling function.





The Controller



Figure 9

- Controlled operation for sample measurements:
 - When the control unit is turned on, the controller will display "Inp" for 2 seconds, followed by a number, also for 2 seconds. The number is the maximum temperature the controller can be set to. To prevent accidental overheating of the thermistor, the maximum temperature should be set to "120" or "120.0", depending on the resolution desired (see below for how to set this.)
 - After 4 seconds, the controller reverts to its standard display, with the current heating block temperature displayed (in red) in the "PV" window and the current set temperature shown (in green) in the "SV" window. By factory default, the controller is in PID mode, with the other settable parameters in suitable ranges for efficient control of the oven.
NOTE: *If you have adjusted these values while investigating the controller*

functions, be sure to reset them to their defaults before using the unit for sample measurements. Turning the control unit off does not return the controller parameters to their factory default values.







- Before changing the set temperature for the first time after turning the unit on, position the heat control potentiometer (3, Figure 4) approximately at its midpoint. This prevents an excessively large heating current from flowing when the controller first turns it on. The desired heater current can be set after the first set temperature is implemented and the controller turns the current on.
- **To change the set temperature SV**, press the “next option” button . The rightmost digit of the SV display begins to blink, and can be adjusted using the up  and down  buttons.
- If the adjustment of the digit goes above “9” or below “0”, the digit and the next digit to the left are automatically adjusted accordingly. Alternatively, you can press  again, and the next digit to the left begins blinking for adjustment.
- When the display shows the desired new SV value, press the set button  to implement the new value.
- The signal lamps:
The upper and lower temperature limit alarm lamps, ALM1 and ALM2 (red), will illuminate if the current temperature PV is more than a certain amount above or below the set value SV. The amount can be adjusted as desired (see below.) The default amount is 10°C. The alarm lamps are informational indicators only and do not affect the controller function. The output ON lamp, OUT (green), will illuminate when the heating current is on.
The automatic mode lamp, AT (green), flashes and the SV display flashes the SV value and “-At-” alternately if the automatic mode is engaged. In the default, the automatic mode is OFF. The automatic mode uses a fuzzy logic algorithm to improve the speed of the heating phase. Once the hold temperature is achieved, it disengages.

APPLICATIONS

Measuring the Sample Characteristics

The variation of the output of the three samples with temperature is conveniently measured by connecting DMM's or other measuring devices to the sample output sockets (5–8, Figure 4) then raising the sample temperature in increments of 5°C by successively resetting the SV value as described above, waiting for the control system to stabilize the new temperature, and reading the outputs.

It is convenient to use a resolution of 0.1°C on the controller for this procedure. This allows more precise recording of the temperatures at which the output readings were taken.

- **To set the temperature resolution** enter the controller's adjustment menu by pressing and holding the set button  for 3 seconds. The first menu entry, AL-1, appears in the PV window. Each subsequent press of the set button  advances the menu to the next entry. Continue pressing the  button until the code "dp" appears (last of 26 entries.) Enable the 0.1°C resolution by using the  and  buttons so that the SV window reads "on." Press  to confirm the choice. After 25 seconds with no further button presses, the controller reverts automatically to the normal functional mode with the new settings implemented.
- To reduce the time between readings at stable temperatures a high heating current (close to 2A) can be set and the cooling fan turned on with the oven lid raised a few millimeters to shorten the recovery time from a temperature overshoot.

Sample Temperature Characteristic Curves

Thermocouple:

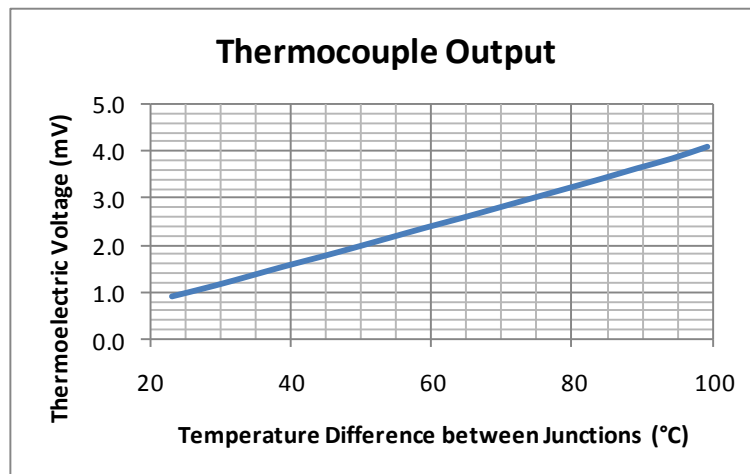

Slope of line: $41.7 \pm 1.4 \mu\text{V}/^\circ\text{C}$

Platinum Resistors:

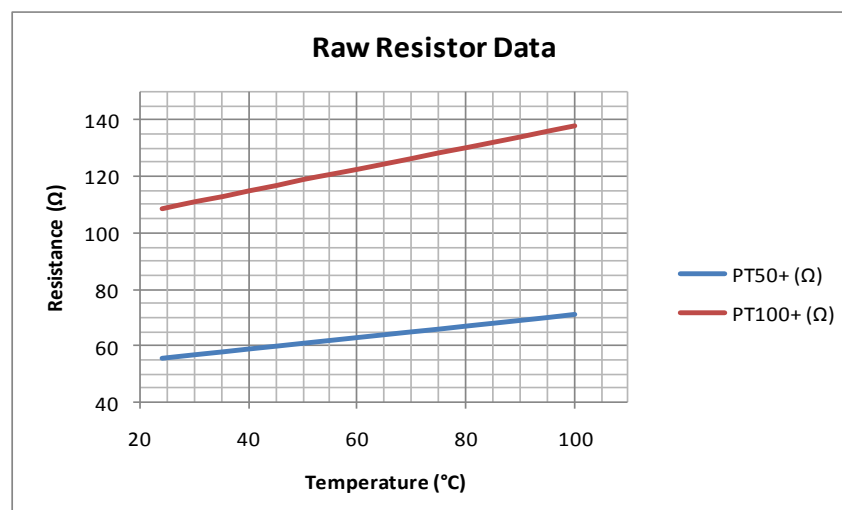

Processed data, showing the 50Ω sensor resistance with the lead effects eliminated:

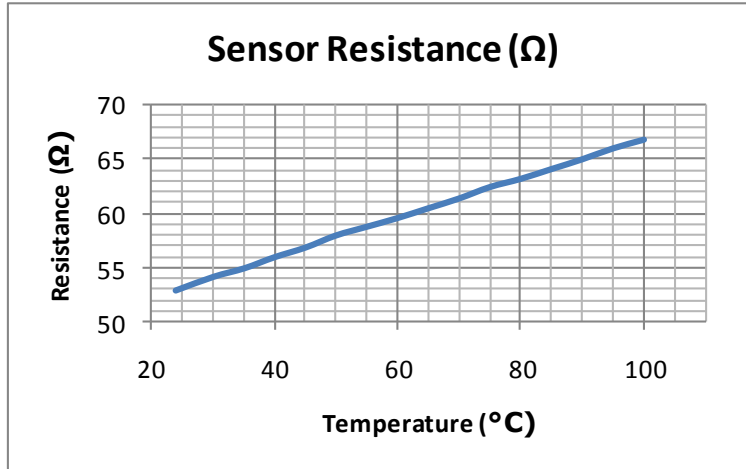

Slope of line: $0.182 \pm 0.009 \text{ } \Omega/^\circ\text{C}$

Thermistor (NTC Resistor):

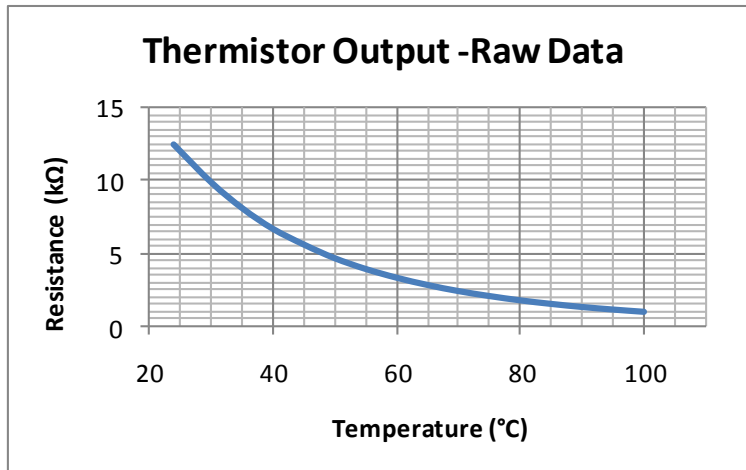

Processed data showing the linear $\ln R$ vs. $1/T$ relationship:

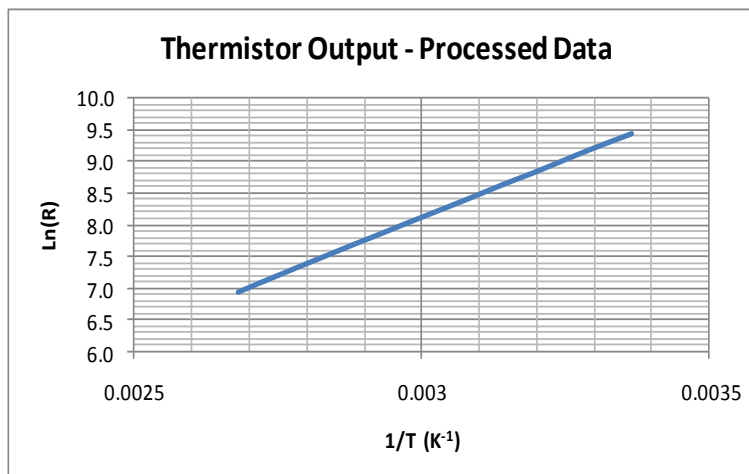

Slope of line: $3655 \pm 52 \text{ K}^{-1}$

Investigating the Digital Control System

The controlled device in this system is an oven with an electrically heated block and natural or forced air cooling. It is a device with a slow response time in both heating and cooling modes. Although the controller has provision for a controlled cooling device, the system does not include one, and so the effects of those parameters relating to cooling cannot be investigated.







The controller can be operated in the P only mode or with any combination of I and D modes added, allowing the influence of these parameters on the stability and performance of the system to be demonstrated.

A detailed description of the theory and practical adjustment of digital control systems is beyond the scope of this manual. The following sources offer thorough treatments:

- FRANKLIN, G.F.; POWELL, J.D. , *Digital control of dynamical systems*, Addison-Wesley. 1981. ISBN 0201820544
- KATZ, P., *Digital control using microprocessors*. Englewood Cliffs: Prentice-Hall, 1981.
- KUO, BENJAMIN C., *Digital Control Systems, 2nd ed.*, U.S.A.: Oxford University Press, 1995 ISBN 0195120647
- OGATA, K., *Discrete-time control systems*, Englewood Cliffs: Prentice-Hall, 1987.
- PHILLIPS, C.L.; NAGLE, H. T. *Digital control system analysis and design*. Englewood Cliffs: Prentice Hall, 1995.
- M. SAMI FADALI; ANTONIO VISIOLI, *Digital Control Engineering*, Academic Press, 2009 ISBN 978-012-374498-2.

The table on the next pages lists all of the adjustable parameters offered on the controller's menu, together with their ranges, effects, and default settings.

To enter the controller's adjustment menu:

- Press and hold the set button  for 3 seconds. The first menu entry, "AL-1", appears in the PV window.
- Each subsequent press of the set button  advances the menu to the next entry.
- The , , , and  buttons are used to select and confirm the option chosen for an entry.
- After stepping through all 26 menu entries, the controller returns to the first entry.
- After 25 seconds with no further button presses, the controller reverts automatically to the normal functional mode with the new settings implemented.

Symbol	Description	Range/Values	Notes	THEA01 Default
AL-1	First alarm (high)	-1999 - +1999	Sets threshold value for first alarm (see also ALP1)	10
AL-2	Second alarm (low)	-1999 - +1999	Sets threshold value for second alarm (see also ALP2)	10
P	P band (heating side)	0.1 – 200% FS	This value needs to be set in PI, PD, and PID modes	0.1
I	Integration time	0 - 360 sec 0 = PD control	Set integration time to eliminate remanent error of P-mode control	240
d	Differentiation time	0 - 360 sec 0 = PI control	Set differentiation time to prevent oscillation and improve control stability	30
AT	Automatic self-regulation	ON/OFF	Enables/disables automatic self-regulation	OFF
T	P relay control	1 - 200 sec	Used to set the reaction time of the P relay and adjust the output power	20
db	Proportional mode dead bandwidth	0 - 10% FS	Sets the size of the P-mode dead band between heating & cooling	0
Hy	Width of relay dead zone	1000 units	Only active when OP-A = OnOf (relay-controlled output)	0
Hy-1	Upper bound of relay dead zone	1000 units	Only active when OP-A = OnOf (relay-controlled output)	1
Hy-2	Lower bound of relay dead zone	1000 units	Only active when OP-A = OnOf (relay-controlled output)	1
Pb	Sensor offset value	±1000 units	Process sensor signal value + this value = Process Value	0
UStP	Automatic regulation mode low Process Value compensation	0.0 - 100.0% FS	Used to reduce process value overshoot in automatic mode	0.0
FILT	Filter coefficient	0 - 1	Software parameter for setting the process measurement sampling. The larger this value, the stronger the protection against noise, but the slower the system response	1
Sn	Sensor input type	J, K, Fe, S, Pt, Cu50	Selects the type of temperature sensor used	Pt
P-SH	Maximum input signal value	Depends on system constraints	Sets the full scale signal value of the process measurement sensor. Cannot exceed 400	120
P-SL	Minimum input signal value	Depends on system constraints	Sets the minimum signal value of the process measurement sensor. Minimum value 0	0
OUTH	Maximum allowable process control output	0.0 – 100.0%	Sets the upper limit of the process signal output. Not available for positional control systems.	100.0

Controller Function Table—continued

Symbol	Description	Range/Values	Notes	THEA01 Default
OUTL	Minimum allowable process control output	0.0 – 99.9%	Sets the lower limit of the process signal output. Not available for positional control systems.	0.0
ALP1	Defines the first alarm function	0 or 1	0 = fixed value alarm (fixed temperature) 1 = tracking alarm (relative to SV)	1
ALP2	Defines the second alarm function	0 or 1	0 = fixed value alarm (fixed temperature) 1 = tracking alarm (relative to SV)	1
COOL	Output type selection	ON/OFF	ON = cooling output OFF = heating output	OFF
OP-A	Main control output method	SSr, rlp, or OnOf	SSr = Pulsed output, SCR controlled rlp = Relay proportional output control OnOf = Relay-controlled output	rlp
OPPO	Turn-on output power	0 – 100%	Process output power at system turn-on	0
C°F	Temperature measurement units	°C or °F	Sets the temperature scale	°C
dp	Temperature resolution	ON/OFF	Enables/disables display resolution of 0.1°C/F (vs. 1°)	OFF

MAINTENANCE

The Thermoelectric Effects Apparatus needs no special maintenance. Store and operate it in a cool, dry place. Take special care to protect the heating block and its connections from mechanical damage and moisture. Do not operate the apparatus in a wet environment. Clean it only with a dry cloth after disconnecting it from the power outlet.

ACCESSORIES AND REPLACEMENT PARTS

The Thermoelectric Effects Apparatus comes with all necessary accessories except the measuring devices for the samples. For replacement of lost or broken parts, contact your United Scientific Supplies distributor.