

Part	No	Material	Size	QTY
Frame	1	L45*5 Angle	2000	2
	2	32*5 Flat Bar	415	4
	3	M10*45 Bolt		4
Grating	4	40*5 Flat Bar	290	68
	5	40*5 Flat Bar	995	4
	6	6*6 Cross Bar	995	6
	7	25*5 Flat Bar	30	4
	8	BUDA.COM.AU	88	2

300HEAVY2

Vincent Buda and Company

Drawings are for guide purposes only and may be subject to change at any time.

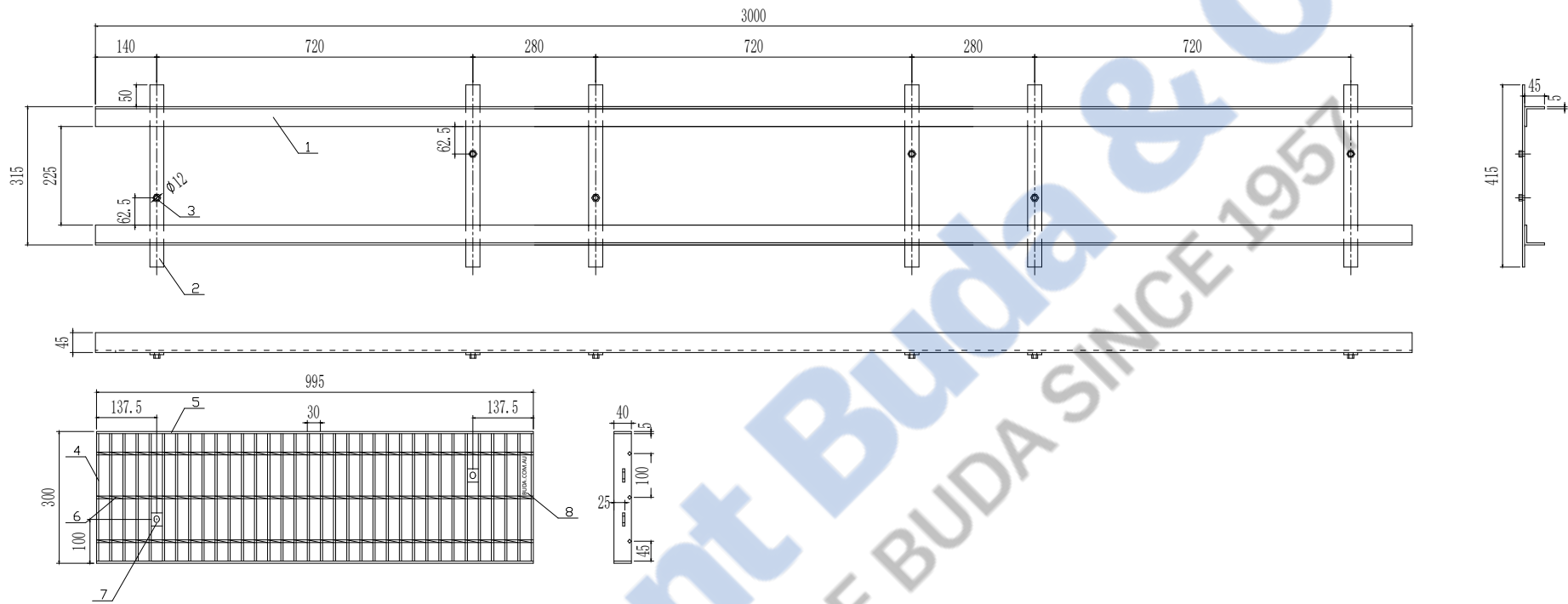

Part	No	Material	Size	QTY
Frame	1	L45*5 Angle	3000	2
	2	32*5 Flat Bar	415	6
	3	M10*45 Bolt		6
Grating	4	40*5 Flat Bar	290	102
	5	40*5 Flat Bar	995	6
	6	6*6 Cross Bar	995	9
	7	25*5 Flat Bar	30	6
	8	BUDA.COM.AU	88	3

300HEAVY3

Vincent Buda and Company

Drawings are for guide purposes only and may be subject to change at any time.