



G2 Series

Locks & latches



Fire Rated: Tested on fire door assemblies in accordance with Australian Standards, refer fire door manufacturer for specific approval details

Legge has long been associated with providing Australasia industry-leading safety, security, style and convenience and the G2 cylindrical lockset is no exception. The G2 lockset offers ANSI/BHMA Grade 2 certification and the Sparta lever, with its 35mm to 45mm clearance, makes it suitable for both residential and light commercial applications requiring compliance with AS1428:1-2009 design for access and mobility code. G2 Series functions include entrance, passage, privacy, patio and dummy trim. Commercial functions such as classroom, storeroom and Vanguard options are also available for added security and safety.

Features

- Sparta lever is compliant with AS1428:1-2009
- Tested in excess of 400,000 operating cycles
- Key removable outside lever for quick and easy cylinder placement
- Snap-on inside rose conceals mounting plate and screws
- Supplied standard with D and T strikes and spacer rings
- Two nickel silver keys per lock supplied with both Schlage 6 pin 'C' keyway and C4 6 pin keyway as standard
- The G2 series is ideally suited for residential, light and medium duty commercial applications
- Non-handed
- The 10 year warranty provides specifiers and users with assured quality and performance

Specification guide

Series	Lever	Function	Finish			
G2	G2	Orbit	O	Passage	PAS	Satin chrome plate..... SCP
		Sparta	S	Privacy.....	.PRI	
				Escape.....	.ESC	
				Entrance.....	.ENT	
				Double cylinder Lock.....	.DCENT	
				Classroom.....	.CLA	
				Store room.....	.STR	
				Dummy trim.....	.DUM	
				Vanguard entrance.....	.VENT	
				Single cylinder deadbolt.....	.G2BOLTSC	
				Double cylinder deadbolt.....	.G2BOLTDC	

Note: Orbit knob only available in G50PD and G80PD Functions

- Series
Select the desired series e.g. G2
- Lever
Select the required lever e.g. Sparta
- Function
Select the required function e.g. G50PD Entrance

Deadbolt

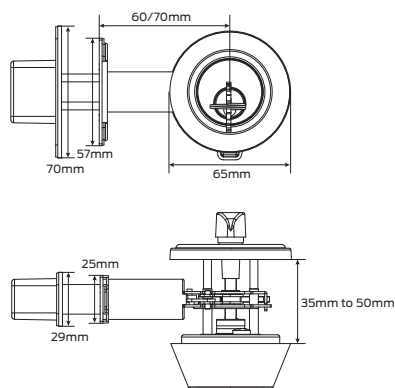

Orbit

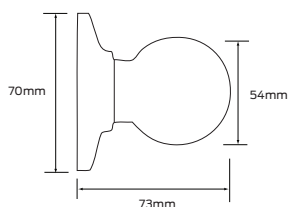



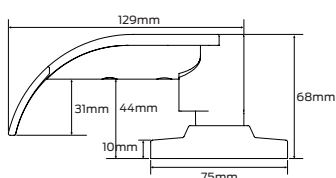







Sparta















Specifications

Door type	Timber or metal
Door thickness	35mm to 50mm 45mm to 60mm available
Chassis	Steel, zinc dichromate plated
Lever	Pressure cast zinc
Knob	Wrought brass
Outer forend	Stainless steel
Bolt	Stainless steel
Strike plate	Stainless steel 45mm standard 22mm optional
Backsets	70mm standard, 60mm and 127mm backset latches available
Key cylinder	Schlage C6 pin keyway and C4 6 pin keyway standard, Schlage E6 pin keyway is optional
Compliance	AS1428:1-2009 design for access and mobility code (Sparta lever)
Finish	Satin chrome plate
Warranty	10 year mechanical

Legge G2 Series non-keyed

Functions	Outside	Inside
Passage latch Both levers always unlocked		
Patio lock Push-button locking. Turning inside lever or closing door releases button, preventing lock-out		
Bath/bedroom privacy lock Push-button locking locks outside lever. Turning inside lever releases button. Outside lever has emergency release		
Escape Deadlatch operated by the inside unrestricted lever only. Blank plate on the outside for extra security against vandalism		
Single dummy trim Dummy trim for one side of door. Used for door pull or as matching inactive trim		

Legge G2 Series keyed

Functions	Outside	Inside
Entrance lock Turn/push-button locking, pushing and turning button locks outside lever requiring use of key until button is manually unlocked Push-button locking: pushing button locks outside lever until unlocked by key or by turning inside lever		
Double cylinder entrance lock Key outside locks/unlocks both handles simultaneously. Key inside locks/unlocks both handles simultaneously		
Classroom lock Outside lever locked and unlocked by key. Inside lever always unlocked		
Storeroom lock Outside lever fixed. Entrance by key only. Inside lever always unlocked		
Single cylinder deadbolt Deadbolt thrown or retracted by key from outside or by turn unit inside. Bolt automatically deadlocks when fully thrown		
Double cylinder deadbolt Deadbolt thrown or retracted by key from either side Bolt automatically deadlocks when fully thrown		

Legge G2 Series Vanguard option

G2 Series keyed lever locks with Vanguard provide vandal resistant technology. Designed for maximum accessibility, security, durability and function, Vanguard sets the standard for door hardware in educational facilities and other applications subject to heavy traffic or abuse. The unique features of Vanguard prevent damage to internal lock components caused by excessive force from individuals kicking, hitting or standing on the lever to gain access. In addition, total facility integration is available with the design and keying compatibility of heavy duty G2 Series lever furniture with Vanguard and standard G2 Series lever functions.

Levers are replacing knobs in the marketplace. The benefit of added grip and leverage that levers provide to those with limited mobility has, however created the opportunity for increased abuse or vandalism. This abuse often renders the lock in-operable, and in some cases, violates the security of the door. While this abuse is commonly associated with schools, it can and does occur in universities, office buildings, commercial and public buildings.

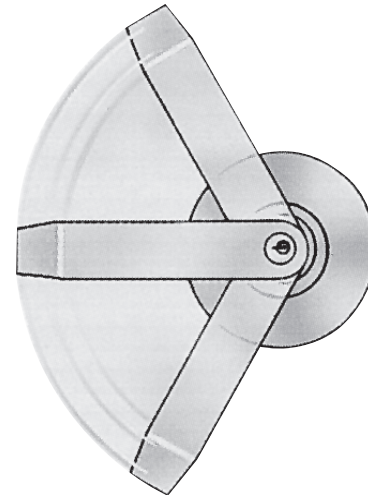

Locked lever freely rotates up and down while remaining securely locked. The Vanguard function also increases resistance to over-rotation of the lever.

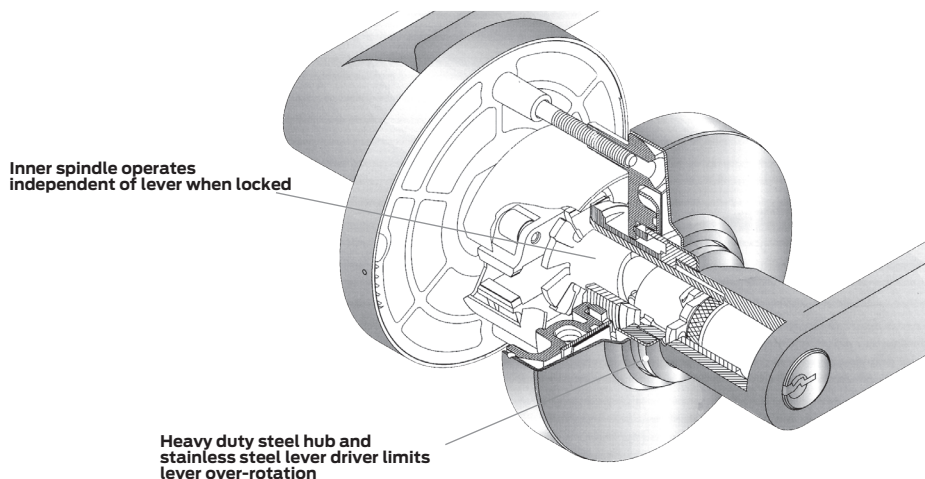

Function

Outside Inside

Entrance/office lock

Push-button locking. Pushing button locks (disengages) outside lever until unlocked with key or by turning inside lever. Inside lever always unlocked. Vanguard is designed to disengage outside spindle from latch with in locked condition



Legge G2 Series accessories

Springlatch

Backset: 60mm, 70mm and 127mm
Finish: Satin chrome plate

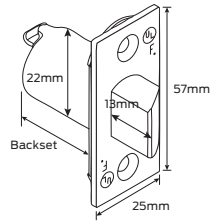

D strike

Finish: Satin stainless steel

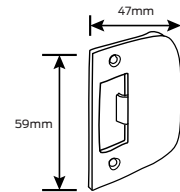

Deadlatch

Backset: 60mm, 70mm and 127mm
Finish: Satin chrome plate

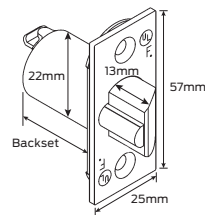

T strike

Finish: Satin stainless steel

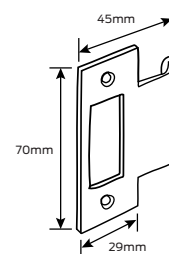

Rebate kit

This kit adapts latches and strikes for 13mm rebated door and frame preparations

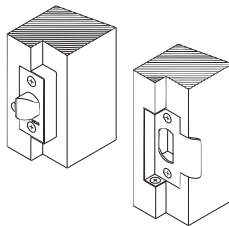

Packing ring

Finish: Satin stainless steel

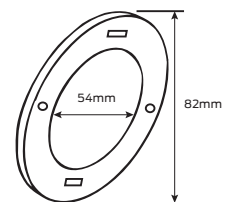



ALLEGION™

PIONEERING SAFETY™

We are
Allegion

Briton ■ LCN ■ LEGGE ■ SCHLAGE ■ VON DUPRIN