



Operator's manual  
**HUSQVARNA AUTOMOWER®**  
**520/550**



EN, English

Read the operator's manual carefully and make sure that you understand the instructions before you use the product.

---

# Contents

---

<b>1 Introduction</b>	
1.1 Support.....	3
1.2 Product description.....	3
1.3 Product overview.....	4
1.4 Symbols on the product.....	5
1.5 Symbols in Automower® Connect.....	5
1.6 Symbols on the battery.....	6
1.7 General manual instructions.....	6
1.8 Overview of the settings structure in Automower® Connect (1).....	7
1.9 Overview of the settings structure Automower® Connect (2).....	8
1.10 Overview of the settings structure in Automower® Connect (3) (Bluetooth® short-range connectivity only).....	9
<b>2 Safety</b>	
2.1 Safety information.....	10
2.2 Safety definitions.....	11
2.3 Safety instructions for operation.....	11
<b>3 Installation</b>	
3.1 Introduction - Installation.....	14
3.2 Main components for installation.....	14
3.3 General preparations.....	14
3.4 Before the installation of the wires.....	14
3.5 Installation of the product.....	19
3.6 To put the wire into position with stakes.....	21
3.7 To bury the boundary wire or the guide wire.....	21
3.8 To extend the boundary wire or the guide wire... ..	22
3.9 After the installation of the product.....	22
3.10 Automower® Connect.....	22
3.11 Settings in Automower® Connect.....	24
<b>4 Operation</b>	
4.1 Main switch.....	30
4.2 Start.....	30
4.3 Operating mode - Start.....	30
4.4 Operating mode - Park.....	31
4.5 To stop the product.....	31
4.6 To switch off the product.....	31
4.7 To adjust the cutting height with Automower® Connect.....	32
4.8 To charge the battery.....	32
<b>5 Maintenance</b>	
5.1 Introduction - maintenance.....	33
5.2 Clean the product.....	33
5.3 Replace the blades.....	34
5.4 Battery.....	34
5.5 Winter service.....	34
<b>6 Troubleshooting</b>	
6.1 Introduction - troubleshooting.....	35
6.2 Fault messages.....	35
6.3 Information messages.....	40
6.4 LED indicator lamp on the charging station.....	42
6.5 LED indicator lamp on the product.....	42
6.6 Symptoms.....	43
6.7 Finding breaks in the loop wire.....	44
<b>7 Transportation, storage and disposal</b>	
7.1 Transportation.....	47
7.2 Storage.....	47
7.3 Disposal.....	47
<b>8 Technical data</b>	
8.1 Technical data.....	48
8.2 Registered trademarks.....	50
<b>9 Warranty</b>	
9.1 Warranty terms.....	51
<b>10 EC Declaration of Conformity</b>	
10.1 EC Declaration of Conformity.....	52

---

# 1 Introduction

---

<b>Serial number:</b>
-----------------------

<b>PIN code:</b>
------------------

The serial number is on the product rating plate and on the product carton.

- Use the serial number to register your product on [www.husqvarna.com](http://www.husqvarna.com).

## 1.1 Support

For support about the product, speak to your Husqvarna servicing dealer.

## 1.2 Product description

---

**Note:** Husqvarna regularly updates the appearance and function of the products. Refer to *Support on page 3*.

---

The product is a robotic lawn mower. The product has a battery power source and cuts the grass automatically. It continuously alternates between mowing and charging. The movement pattern is random, which means that the lawn is mowed evenly and with less wear. The boundary wire and the guide wire controls the movement of the product within the work area. Sensors in the product senses when it is approaching the boundary wire. The front of the product always passes the boundary wire by a specific distance before the product turns around. When the product hits an obstacle or approaches the boundary wire the product selects a new direction.

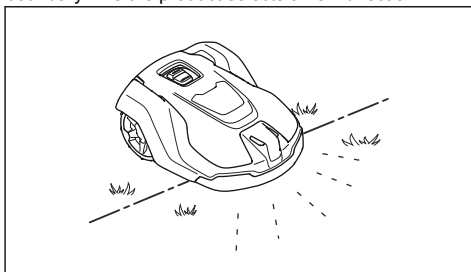

The operator selects the operation settings in the Automower® Connect app. The app shows the selected and possible operation settings, and the operation mode of the product.

### 1.2.1 Mowing technique

The product is emission free, easy to use and saves energy. The frequent cutting technique improves the grass quality and decreases the use of fertilizers. Collection of grass is not necessary.

### 1.2.2 Find the charging station

The product operates until the battery state of charge is low, then it starts to go to the charging station. The product has 3 search methods to find the charging station. Refer to *To find the charging station on page 25*.

### 1.2.3 Automower® Connect

Automower® Connect is a mobile application that makes it possible to select the operation settings remotely. Refer to *Automower® Connect (Bluetooth® only) on page 29*.

### 1.3 Product overview

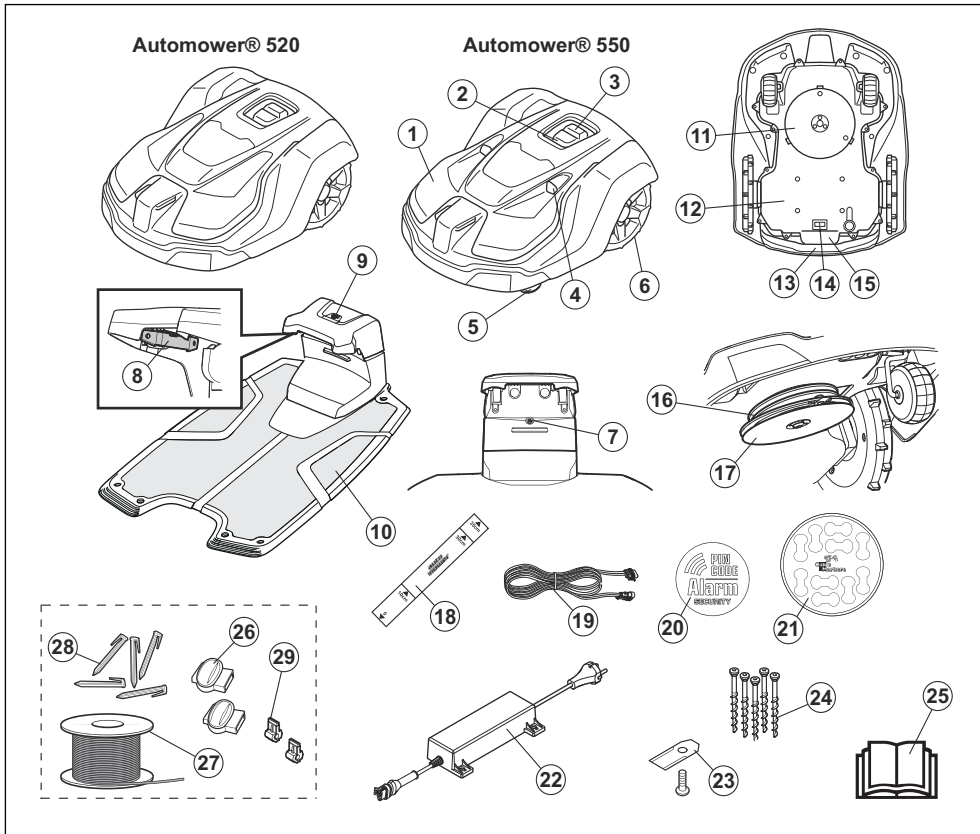

The numbers in the illustration represent:

- |  |  |
|--|--|
| 1. Body  | 13. Handle   |
| 2. LED indicator lamp of the product                 | 14. Main switch  |
| 3. STOP/START button                                 | 15. Rating plate (including product identification code) |
| 4. Ultrasonic sensors                                | 16. Blade disc   |
| 5. Front wheels                                      | 17. Skid plate   |
| 6. Rear wheels                                       | 18. Measurement gauge                                    |
| 7. LED indicator lamp of the charging station        | 19. Low voltage cable                                    |
| 8. Contact strips                                    | 20. Alarm decal  |
| 9. Park button                                       | 21. Cable markers  |
| 10. Charging station                                 | 22. Power supply <sup>1</sup>                            |
| 11. Cutting system                                   | 23. Extra blades   |
| 12. Chassis box with electronics, battery and motors | 24. Screws for securing the charging station             |
|  | 25. Operator's manual and Quick Guide                    |
|  | 26. Couplers for loop wire <sup>2</sup>                  |

<sup>1</sup> The appearance may differ depending on market

<sup>2</sup> Is a part of the Installation kit which is purchased separately.

- 27. Loop wire for boundary loop and guide wire <sup>3</sup>
- 28. Stakes<sup>4</sup>
- 29. Connector for the loop wire <sup>5</sup>

## 1.4 Symbols on the product

These symbols can be found on the product. Study them carefully.



**WARNING:** Read the user instructions before operating the product.



**WARNING:** Disable the product before working on or lifting the product.



**WARNING:** Keep a safe distance from the product when operating. Keep your hands and feet away from the rotating blades.



**WARNING:** Do not ride on the product. Never put your hands or feet close to or under the product.

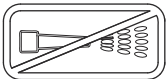

Never use a high-pressure washer or even running water to clean the product.

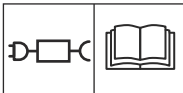

Use a detachable power supply as defined on the rating label next to the symbol.



This product conforms to the applicable EC Directives.



It is not permitted to dispose this product as normal household waste. Ensure that the product is recycled in accordance with local legal requirements.



The chassis contains components which are sensitive to electrostatic discharge (ESD). The chassis must also be resealed in a professional manner. For these reasons the chassis shall only be opened by authorized service technicians. A broken seal can result in the entire or parts of the warranty no longer being valid.



The low-voltage cable must not be shortened, extended or spliced.

Do not use a trimmer nearby the low-voltage cable. Be careful when trimming edges where the cables are placed.

## 1.5 Symbols in Automower® Connect



The schedule menu is used to set when the product cuts the lawn.



The cutting height menu allows the operator to set the cutting height of the product.



The operation menu is used for manual settings for the operation.



The installation menu is used for manual settings for the installation.



The accessories menu is used for settings made for the accessories.



The settings menu is used to set the general product settings. (Only available for Bluetooth® short-range connectivity)



The security menu lets the operator select between 3 security levels. (Only available for Bluetooth® short-range connectivity)

<sup>3</sup> See note 2

<sup>4</sup> See note 2

<sup>5</sup> See note 2



Automower® Connect is where the operator enables and disables the Automower® Connect module on the product. (Only available for Bluetooth® short-range connectivity)

## 1.6 Symbols on the battery



Read the user instructions.



Do not discard the battery into fire and do not expose the battery to a heat source.



Do not immerse the battery into water.

## 1.7 General manual instructions

The following system is used in the Operator's Manual to make it easier to use:

- Text written in *italics* is a text that is in the Automower® Connect app, or is a reference to another section in the Operator's manual.
- Text written in **bold** is one of the buttons on the product or in .

# 1.8 Overview of the settings structure in Automower® Connect (1)

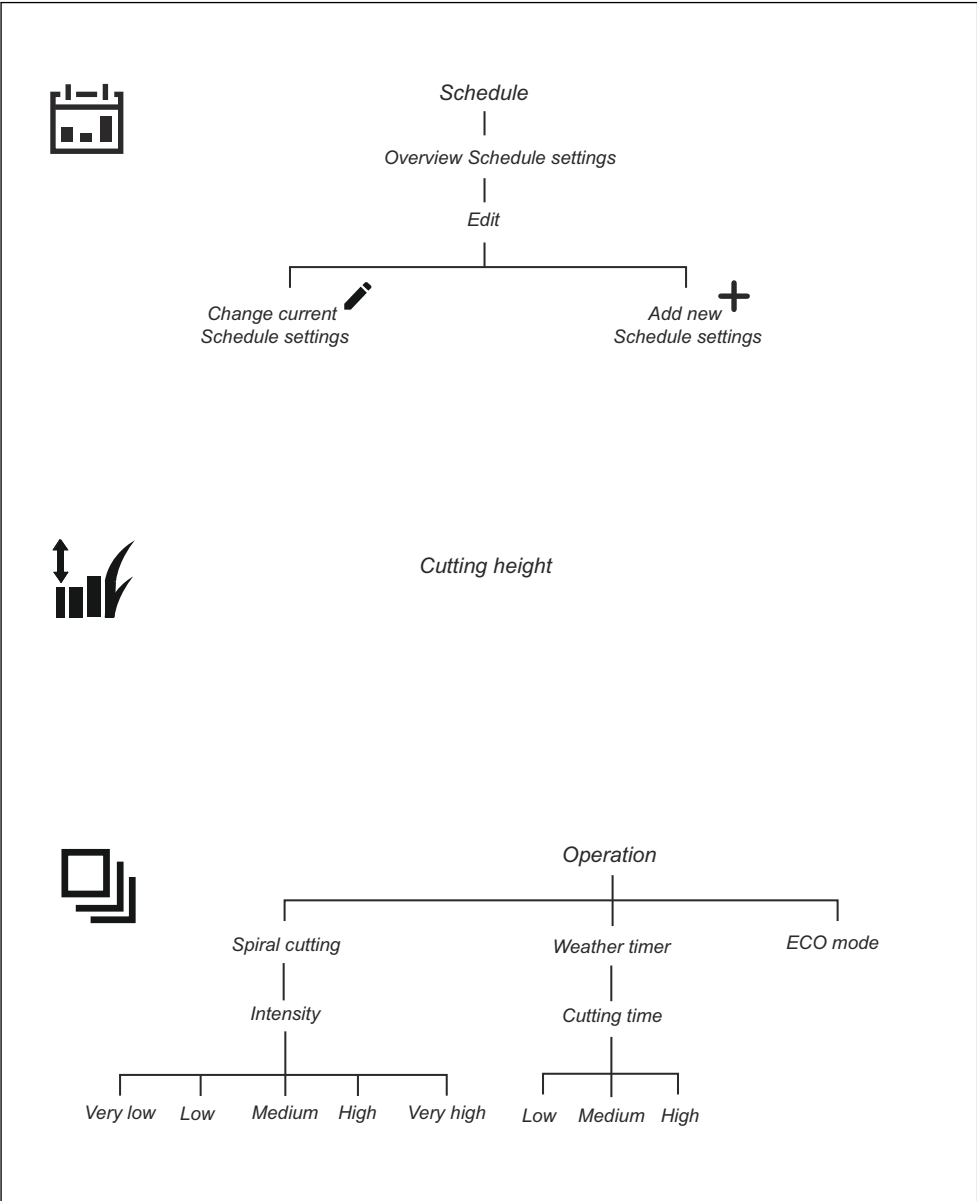

## 1.9 Overview of the settings structure Automower® Connect (2)

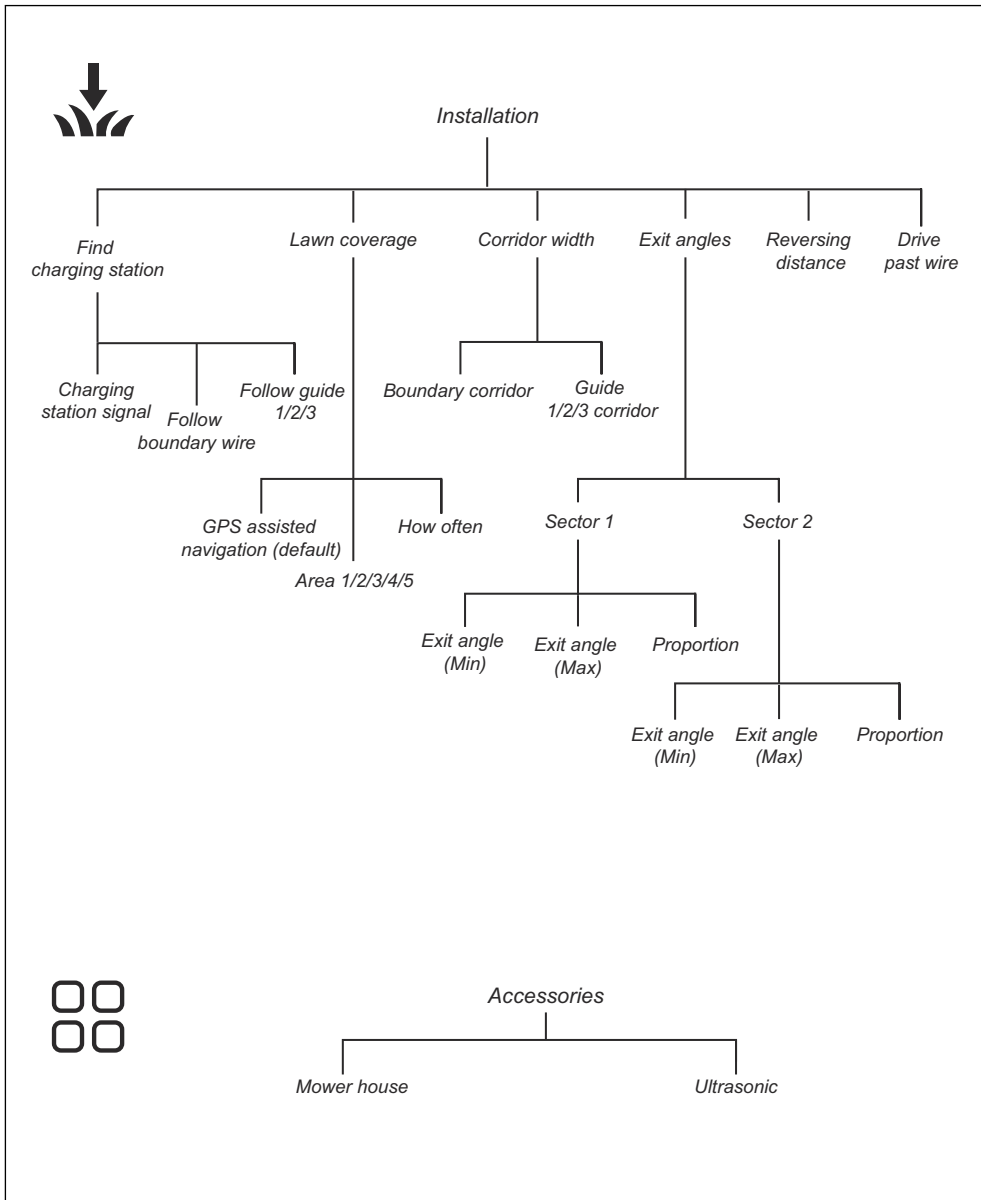



**1.10 Overview of the settings structure in Automower® Connect (3) (Bluetooth® short-range connectivity only)**

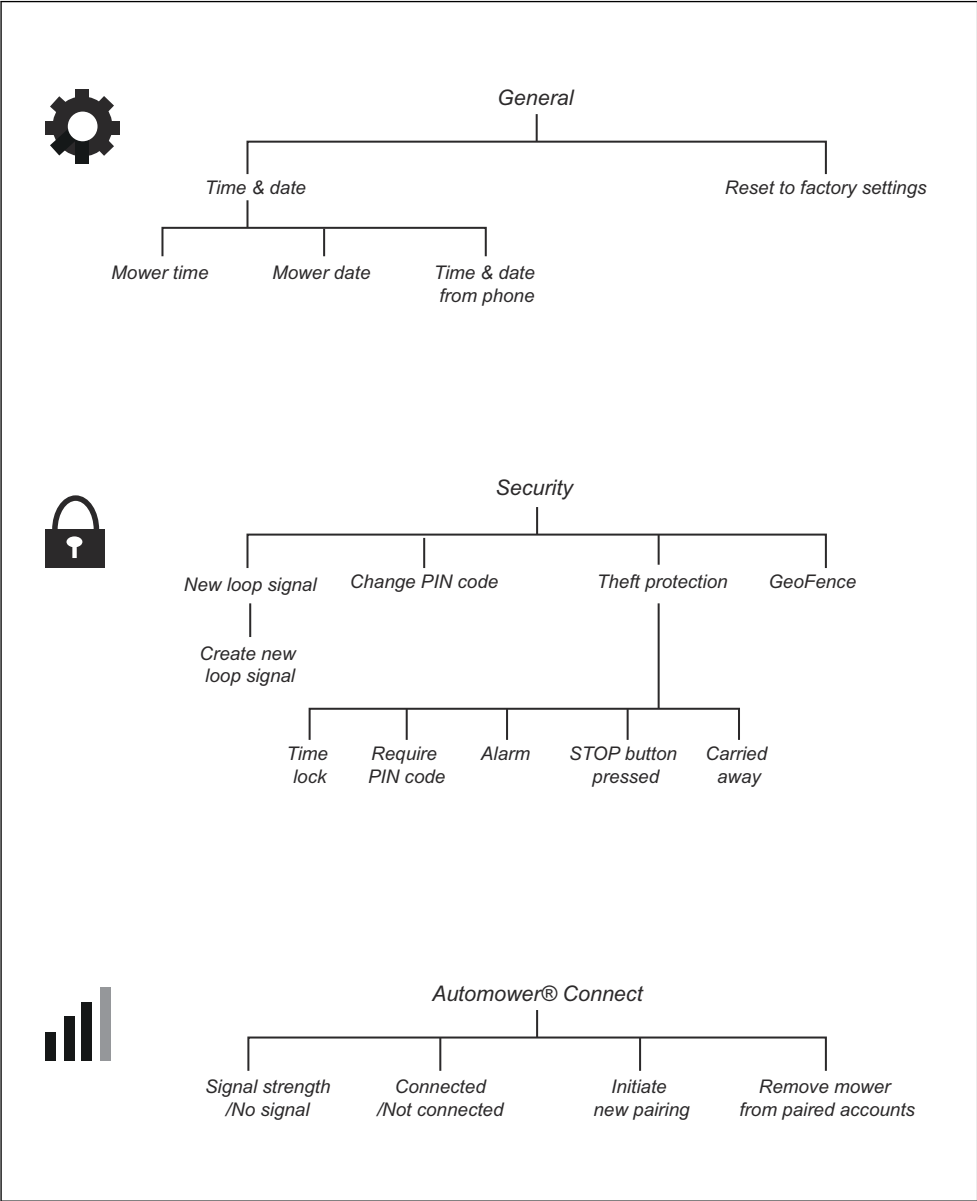

### 2.1 Safety information

#### **2.1.1 IMPORTANT. READ CAREFULLY BEFORE USE. KEEP FOR FUTURE REFERENCE**

The operator is responsible for accidents or hazards occurring to other people or property.

This appliance is not intended for use by persons (including children) with reduced physical, sensory or mental capabilities (that could affect a safe handling of the product), or lack of experience and knowledge, unless they have been given supervision or instruction concerning use of the appliance by a person responsible for their safety.

This appliance can be used by children aged from 8 years and above and persons with reduced physical, sensory or mental capabilities or lack of experience and knowledge if they have been given supervision or instruction concerning use of the appliance in a safe way and understand the hazards involved. Local regulations may restrict the age of the operator. Cleaning and maintenance shall not be made by children without supervision.

Never connect the power supply to an outlet if the plug or cord is damaged. Worn or damaged cord increase the risk of electric shock.

Only charge the battery in the included charging station. Incorrect use may result in electric shock, overheating or leaking of corrosive liquid from the battery. In the event of leakage of electrolyte, flush with water/neutralizing agent. Seek medical help if it comes in contact with the eyes.

Use only original batteries recommended by the manufacturer. Product safety cannot be guaranteed with other than original batteries. Do not use non-rechargeable batteries.

The appliance must be disconnected from the supply mains when removing the battery.



**WARNING:** The product can be dangerous if used incorrectly.



**CAUTION:** Used if there is a risk of damage to the product, other materials or the adjacent area if the instructions in the manual are not obeyed.



**WARNING:** Do not use the product when persons, especially children, or animals are in the work area.

**Note:** Used to give more information that is necessary in a given situation.



**WARNING:** Keep your hands and feet away from the rotating blades. Never put your hands or feet close to or under the product when it is switched on.

## 2.3 Safety instructions for operation

### 2.3.1 Use

- The product may only be used with the equipment recommended by the manufacturer. All other types of use are incorrect. The manufacturer's instructions with regard to operation/maintenance must be followed precisely.
- The product may only be operated, maintained and repaired by persons that are fully conversant with its special characteristics and safety regulations. Please read the Operator's Manual carefully and make sure you understand the instructions before using the product.
- It is not permitted to modify the original design of the product. All modifications are made at your own risk.
- Warning signs shall be placed around the work area of the product if it is used in public areas. The signs shall have the following text: **Warning! Automatic lawn mower! Keep away from the machine! Supervise children!**



**WARNING:** In the event of an injury or accident seek medical help.

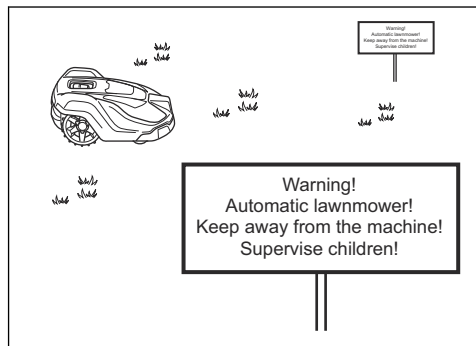

## 2.2 Safety definitions

Warnings, cautions and notes are used to point out specially important parts of the manual.



**WARNING:** Used if there is a risk of injury or death for the operator or bystanders if the instructions in the manual are not obeyed.

- Use the park mode, refer to *Operating mode - Park on page 31* or switch off the product when persons, especially children or animals are in the work area. Refer to *To switch off the product on page 31*. It is recommended to program the product for use during hours when the area is free

from activity. Consider that certain animals, e.g. hedgehogs, are active at night. They can potentially be harmed by the product. Refer to *Schedule on page 24*.

- Do not install the charging station, including any accessory, at a location that is below, or within 60 cm / 24 in. from, any combustible material. Do not install the power supply unit in easily flammable surroundings. In case of malfunction, heating of the charging station and the power supply may occur and create a potential risk of fire.
- Check that there are no foreign objects such as stones, branches, tools or toys on the lawn. If the blades hit foreign objects the blades can be damaged. Always switch off the product before clearing a blockage. Inspect the product for damage before starting the product again. Refer to *To switch off the product on page 31*.

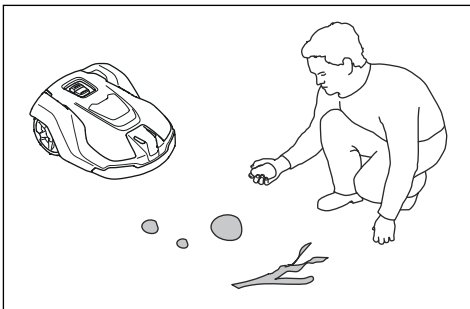

- If the product starts to vibrate abnormally. Always switch off the product and inspect for damage before starting the product again. Refer *To switch off the product on page 31*.
- Switch on the product according to the instructions. When the product is switched on; make sure to keep your hands and feet away from the rotating blades. Never put your hands and feet under the product.
- Never touch moving hazardous parts, such as the blade disc, before it has come to a complete stop.
- Never lift up the product or carry it around when it is switched on.
- The product must never be allowed to collide with persons or other living creatures. If a person or other living creature comes in the way of the product, it shall be stopped immediately. Refer to *To stop the product on page 31*.
- Do not put anything on top of the product or its charging station.
- Do not allow the product to be used with a defective guard, blade disc or body. Neither should it be used with defective blades, screws, nuts or cables. Never connect a damaged cable, or touch a damaged cable before it is disconnected from the supply.

- Do not use the product if the **STOP** button does not work.
- Always switch off the product when it is not in use. The product can only start when the correct PIN code has been entered.
- The product must never be used at the same time as a sprinkler. Use the *Schedule* function so the product and sprinkler never run simultaneously. Refer to *Schedule on page 24*.
- Husqvarna does not guarantee full compatibility between the product and other types of wireless systems such as remote controls, radio transmitters, hearing loops, underground electric animal fencing or similar.
- The built-in alarm is very loud. Be careful, especially if the product is handled indoors.
- Metal objects in the ground (for example reinforced concrete or anti-mole nets) can result in a stoppage. The metal objects can cause interference with the loop signal which then can lead to a stoppage.
- Operation and storage temperature is 0-50 °C / 32-122 °F. Temperature range for charging is 0-45 °C / 32-113 °F. Too high temperatures might cause damage to the product.

### 2.3.2 Battery safety



**WARNING:** Lithium-ion batteries can explode or cause fire if disassembled, short-circuited, exposed to water, fire, or high temperatures. Handle carefully, do not dismantle, open the battery or use any type of electrical/mechanical abuse. Avoid storage in direct sunlight.

For more information about the battery, refer to *Technical data on page 48*

### 2.3.3 How to lift and move the product



**WARNING:** The product must be switched off before lifting it. The product is disabled when the **Main switch** is in position 0.



**CAUTION:** Do not lift the product when it is parked in the charging station. It can damage the charging station and/or the product. Push **STOP** and pull the product out of the charging station before lifting it.

To safely move from or within the work area:

1. Push the **STOP** button to stop the product.

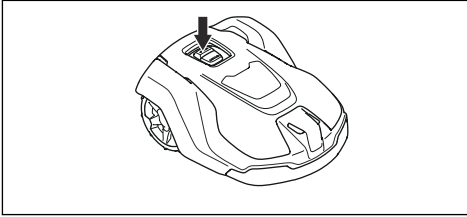

2. Set the main switch in position 0.

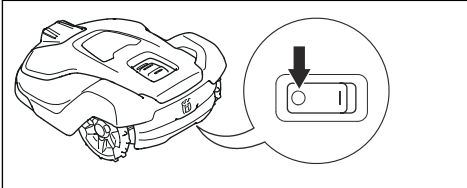

3. Carry the product by the handle with the blade disc away from the body.



### 2.3.4 Maintenance



**WARNING:** When the product is turned upside down the main switch must always be in the 0 position.

The main switch should be set in the 0 position before all work on the chassis of the product, such as cleaning or replacing the blades.

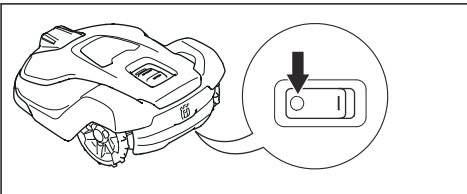

**CAUTION:** Never use a high-pressure washer or even running water to clean the product. Never use solvents for cleaning.



**CAUTION:** Use the plug to disconnect the charging station before any cleaning or maintenance of the charging station or the loop wire.

Inspect the product each week and replace any damaged or worn parts. Refer to *Maintenance on page 33*.

### 2.3.5 In the event of a thunderstorm

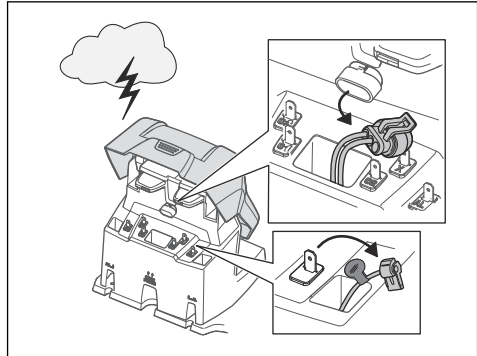

To reduce the risk of damage to electrical components in the product and the charging station, we recommend that all connections to the charging station are disconnected (power supply, boundary wire and guide wire) if there is a risk of a thunderstorm.

1. Mark the wires to simplify reconnecting. The charging station's connections are marked AR, AL and G1/G2/G3.
2. Disconnect all connected wires and the power supply.
3. Connect all the wires and the power supply if there is no longer a risk of thunder. It is important that each wire is connected to the right place.

---

## 3 Installation

---

### 3.1 Introduction - Installation

---



**WARNING:** Read and understand the safety chapter before you install the product.



**CAUTION:** Use original spare parts and installation material.

**Note:** Refer to [www.husqvarna.com](http://www.husqvarna.com) for more information about installation.

Automower® 550 has the Automower® Club Solution where you can use 2 or 3 products in the same installation, refer to *Automower® Club Solution on page 19*.

### 3.2 Main components for installation

The installation involves the following components:

- A robotic lawn mower that mows the lawn automatically.
- A charging station, which has 3 functions:
  - To send control signals along the boundary wire.
  - To send control signals along the guide wire so that the product can follow the guide to specific remote areas in the garden and can find its way back to the charging station.
  - To charge the product.
- A power supply, which is connected to the charging station and a 100-240V power outlet.
- Loop wire, which is laid around the work area and around objects and plants that the product must not run into. The loop wire is used both as boundary wire and guide wire.

### 3.3 General preparations

---



**CAUTION:** Holes with water in the lawn can cause damage to the product.

**Note:** Read through the Installation chapter before beginning the installation. How the installation is done affects how the product performs. It is therefore important to plan the installation carefully.

- Make a blueprint of the work area and include all obstacles. This makes it easier to see the ideal

positions for the charging station, the boundary wire and the guide wire.

- Make a mark on the blueprint where to put the charging station, the boundary wire and the guide wire.
- Make a mark on the blueprint where the guide wire connects to the boundary wire. Refer to *To install the guide wire on page 21*.
- Fill in holes in the lawn.
- Cut the grass before you install the product. Make sure that the grass is maximum 10 cm / 4 in.

**Note:** The first weeks after installation the perceived sound level when cutting the grass may be higher than expected. When the product has cut the grass for some time, the perceived sound level is much lower.

### 3.4 Before the installation of the wires

You can select to attach the wires with stakes or bury them. You can use the 2 procedures for the same work area.



**CAUTION:** If you use a dethatcher in the work area, bury the boundary wire and the guide wire to prevent them from damage.

#### 3.4.1 To examine where to put the charging station

- Keep a minimum 2 m / 7 ft. of free space in front of the charging station. Refer to *To examine where to put the guide wire on page 18*.
- Keep a minimum of 150 cm / 60 in. of free space to the right and left of the center of the charging station.
- Put the charging station near a power outlet.
- Put the charging station on a level surface.
- The baseplate of the charging station must not be bent.

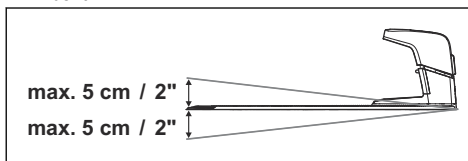

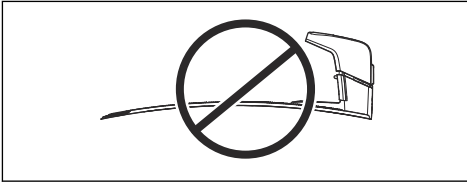

- If the work area has two parts separated with a steep slope, we recommend to put the charging station in the lower section.
- Put the charging station in an area with protection from the sun.
- If the charging station is installed on an island, make sure to connect the guide wire to the island. Refer to *To make an island on page 17*.

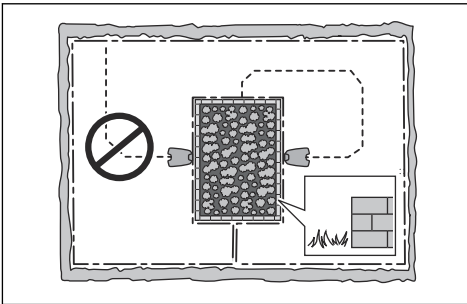

### 3.4.2 To examine where to put the power supply



**WARNING:** Do not cut or extend the low-voltage cable. There is a risk of electrical shock.



**CAUTION:** Make sure that the blades on the product do not cut the low-voltage cable.



**CAUTION:** Do not put the low-voltage cable in a coil or below the charging station plate. The coil causes interference with the signal from the charging station.



- Put the power supply in an area with a roof and protection from the sun and rain.
- Put the power supply in an area with good airflow.

- Use a residual-current device (RCD) with a tripping current of maximum 30 mA when you connect the power supply to the power outlet.

Low-voltage cables of different lengths are available as accessories.

### 3.4.3 To examine where to put the boundary wire



**CAUTION:** There must be a barrier of minimum 15 cm / 6 in. in height between the boundary wire and water bodies, slopes, precipices or public roads. This will prevent damage to the product.



**CAUTION:** Do not let the product operate on gravel.



**CAUTION:** Do not make sharp bends when you install the boundary wire.



**CAUTION:** For careful operation without noise, isolate all obstacles such as trees, roots and stones.

The boundary wire should be put as a loop around the work area. Sensors in the product senses when the product approaches the boundary wire, and the product selects another direction. All parts of the work area must be maximum 35 m / 115 ft. from the boundary wire.

To make the connection easier between the guide wire and the boundary wire, it is recommended to make an eyelet where the guide wire will be connected. Make the eyelet with approximately 20 cm / 8 in. of the boundary wire.

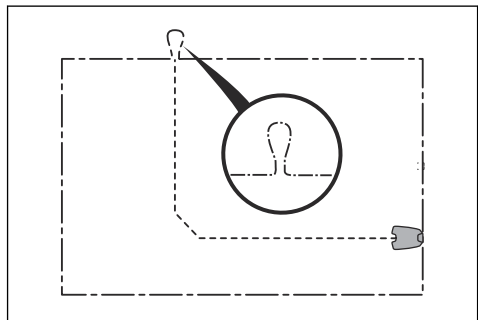

**Note:** Make a blueprint of the work area before you install the boundary wire and guide wire.

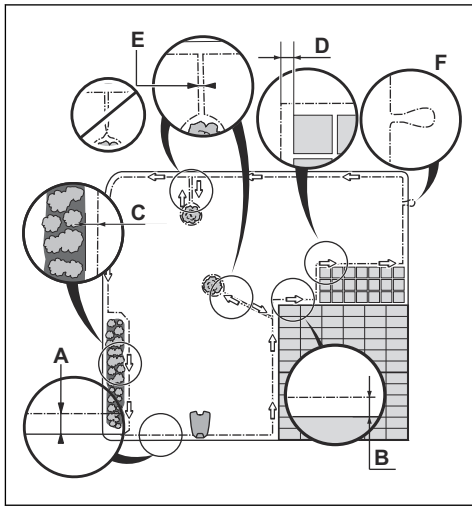

- Put the boundary wire around all of the work area (A). Adapt the distance between the boundary wire and obstacles.
- Put the boundary wire 35 cm / 14 in. (B) from an obstacle that is more than 5 cm / 2 in. high.

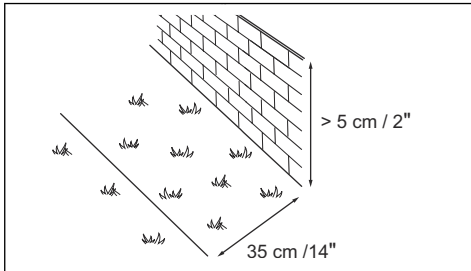

- Put the boundary wire 30 cm / 12 in. (C) from an obstacle that is 1-5 cm / 0.4-2 in. high.

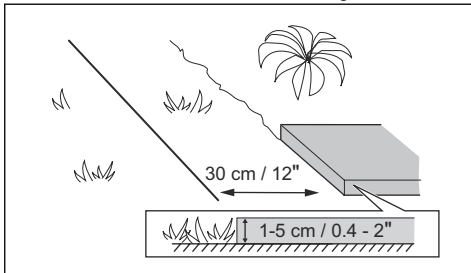

- Put the boundary wire 10 cm / 4 in. (D) from an obstacle that is less than 1 cm / 0.4 in. high.

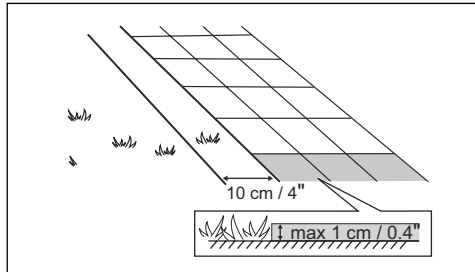

- If you have a paving stone path that is in level with the lawn, put the boundary wire below the paving stone.

**Note:** If the paving stone is minimum 30 cm / 12 in. wide, use the factory setting for the *Drive Past Wire* function to cut all the grass adjacent to the paving stone. Refer to *Drive Past Wire* on page 27.

- If you make an island, put the boundary wire that runs to and from the island near together (E). Put the wires in the same stake. Refer to *To make an island* on page 17.
- Make an eyelet (F) where the guide wire is to be connected to the boundary wire.

#### 3.4.3.1 To put the boundary wire in a slope

The product can operate in 45% slopes. Slopes that are too steep must be isolated with the boundary wire. The gradient (%) is calculated as height per m. Example: 10 cm / 100 cm = 10%.

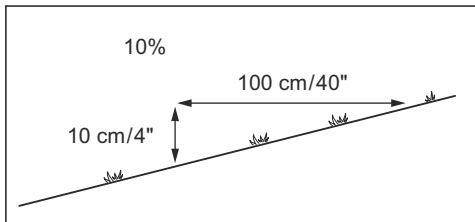

- For slopes steeper than 45% inside the work area, isolate the slope with boundary wire.
- For slopes steeper than 15% along the outer edge of the lawn, put the boundary wire 20 cm / 8 in. (A) from the edge.
- For slopes adjacent to a public road, put a barrier of minimum 15 cm / 6 in. along the outer edge of the slope. You can use a wall or a fence as a barrier.

#### 3.4.3.2 Passages

A passage is a section that has boundary wire on each side and that connects 2 parts of the work area. The distance between the boundary wire on each side in the passage must be a minimum of 60 cm / 24 in.



**Note:** If a passage is less than 2 m / 6.5 ft. wide, install a guide wire through the passage.

The recommended minimum distance between the guide wire and the boundary wire is 30 cm / 12 in. The product always runs to the left of the guide wire as seen facing the charging station. It is recommended to have as much free area as possible to the left of the guide wire (A).

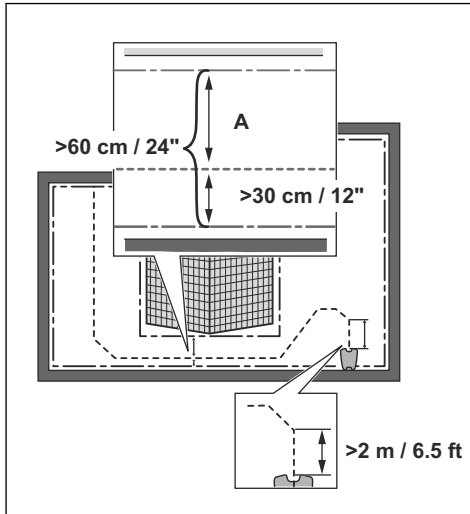

#### 3.4.3.3 To make an island



**CAUTION:** Do not put a section of boundary wire across the other. The sections of boundary wire must be parallel.



**CAUTION:** Do not put the guide wire across the boundary wire.



**CAUTION:** Isolate or remove obstacles that are less than 15 cm / 5.9 in. in height. Isolate or remove obstacles that slope slightly, for example, stones, trees or roots. This will prevent damage to the blades of the product.

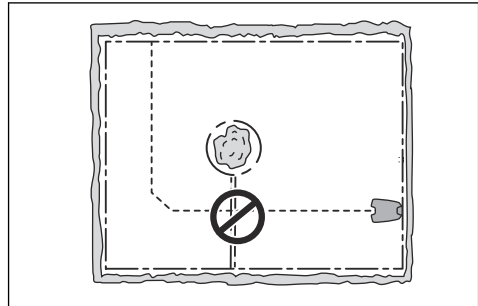

To make an island, isolate areas in the work area with the boundary wire. We recommend to isolate all stable objects in the work area.

Some obstacles are resistant to a collision, for example, trees or bushes that are more than 15 cm / 5.9 in. in height. The product will collide with the obstacle and then select a new direction.

- Put the boundary wire to and around the obstacle to make an island.
- Put the 2 sections of boundary wire to and from the island close together. This will make the product run across the wire.
- Put the 2 sections of boundary wire in the same stake.

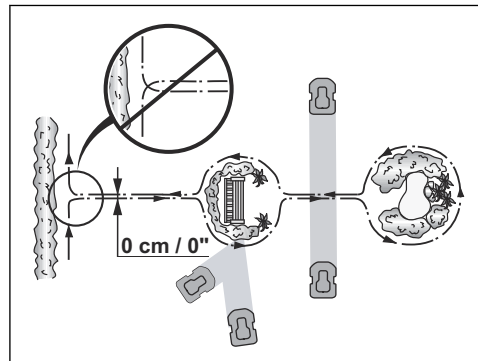

#### 3.4.3.4 To make a secondary area

Make a secondary area (B) if the work area has 2 areas that are not connected with a passage. The work area with the charging station is the main area (A).

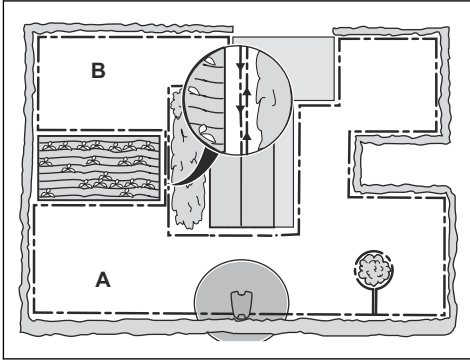

**Note:** The product must be manually moved between the main area and the secondary area.

- Put the boundary wire around the secondary area (B) to make an island. Refer to *To make an island on page 17*.

**Note:** The boundary wire must be put as 1 loop around all of the work area (A + B).

**Note:** When the product cuts grass in the secondary area, the *Secondary area mode* must be selected. Refer to *Operating mode - Start on page 30*.

### 3.4.4 To examine where to put the guide wire

- Put the guide wire in a line at a minimum of 2 m / 7 ft. in front of the charging station.
- Make as much free area as possible to the left of the guide wire when facing the charging station. Refer to *To examine where to put the charging station on page 14*.
- Put the guide wire minimum 30 cm / 12 in. from the boundary wire.
- Do not make sharp bends when you install the guide wire.

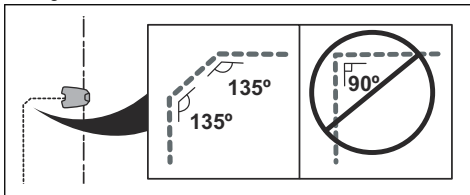

- If the work area has a slope, put the guide wire diagonally across the slope.

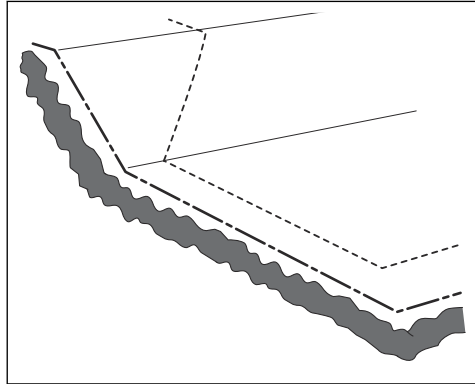

### 3.4.5 Work area examples

- If the charging station is put in a small area (A), make sure that the distance to the boundary wire is at a minimum 3 m / 10 ft. in front of the charging station.
- If the work area has a passage (B) with no guide wire installed, the recommended minimum distance between the boundary wires is 2 m / 6.5 ft. With a guide wire installed through the passage, the recommended minimum distance between the boundary wires is 60 cm / 24 in.
- If the work area has areas which are connected by a narrow passage (B), you can set the product to first follow and then leave the guide wire after a certain distance (C). The settings can be changed in *Lawn coverage on page 26*.
- Use the GPS Assisted Navigation that helps the product select the most optimal operation. Refer to *Lawn coverage on page 26*.
- If the work area includes a secondary area (D), refer to *Secondary area on page 30*. Put the product in the secondary area and select *Secondary area mode*.

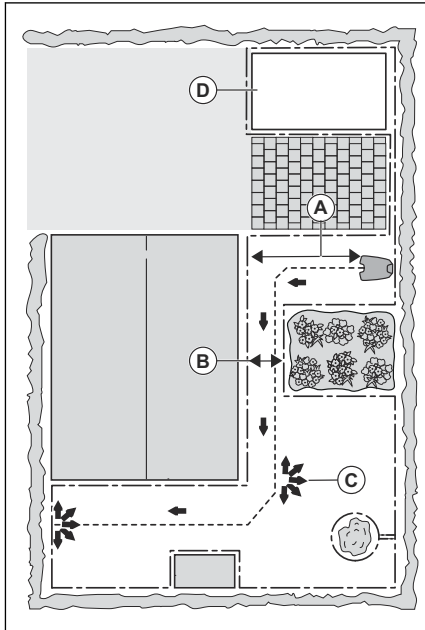

### 3.4.6 Automower® Club Solution

Automower® Club Solution makes it possible to use 2 or 3 products in one installation. It requires special configuration in the product and the installation of the boundary wires and charging stations is different. To use Automower® Club Solution, speak to your local Husqvarna representative.

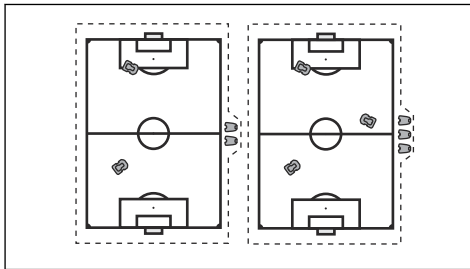

The installation of the boundary wire and charging stations must be made in parallel. The recommended distance (A) between the charging stations is 5 m / 16 ft. Maximum width of the work area is 70 m / 230 ft.

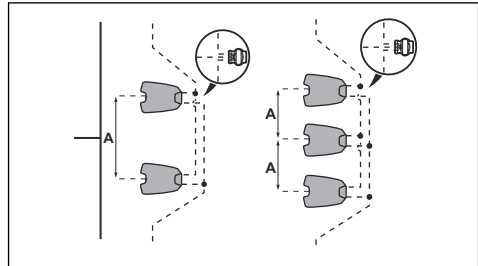

The changes when using the Automower® Club Solution configuration are:

- The product will find the charging station with the charging station signal or follow the boundary wire clockwise.
- You cannot use guide cables.
- You cannot use the **Park** button.
- The blade disc speed and noise level increases.

## 3.5 Installation of the product

### 3.5.1 Installation tools

- Hammer/plastic mallet: To simplify putting the stakes into the ground.
- Edge cutter/straight spade: To bury the boundary wire.
- Combination pliers: For cutting the boundary wire and pressing the connectors together.
- Adjustable plier: For pressing the couplers together.

### 3.5.2 To install the charging station



**WARNING:** Obey national regulations about electrical safety.



**WARNING:** The product is only to be used with the power supply unit supplied by Husqvarna.



**WARNING:** Do not put the power supply at a height where there is a risk it can be put in water. Do not put the power supply on the ground.



**WARNING:** Do not encapsulate the power supply. Condensed water can harm the power supply and increase the risk of electrical shock.



**WARNING:** Risk of Electric Shock. Install only to a residual-current device (RCD) with a tripping current of maximum 30 mA when connecting the power supply to the power outlet. Applicable to USA/Canada. If power supply is installed outdoors: Risk of Electric Shock. Install only to a covered Class A GFCI receptacle (RCD) that has an enclosure that is weatherproof with the attachment plug cap inserted or removed.



**CAUTION:** Do not make new holes in the charging station plate.



**CAUTION:** Do not put your feet on the baseplate of the charging station.



**WARNING:** The power supply cable and extension cable must be outside the work area to avoid damage to the cables.

When connecting the power supply, only use a power outlet that is connected to a residual-current device (RCD).

1. Read and understand the instructions about where to put the charging station. Refer to *To examine where to put the charging station on page 14*.
2. Put the charging station in the selected area.

**Note:** Do not attach the charging station with the screws to the ground until the guide wire is installed. Refer to *To install the guide wire on page 21*.

3. Connect the low-voltage cable to the charging station.
4. Put the power supply at a minimum height of 30 cm / 12 in.

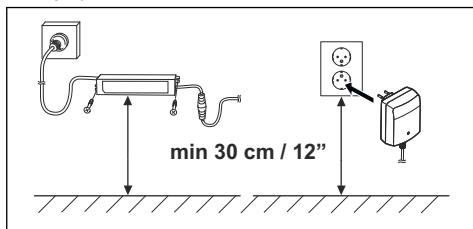

5. Connect the power supply cable to a 100-240V power outlet.

**Note:** When the charging station is connected, it is possible to charge the product. Put the product

in the charging station while the boundary and guide wires are being laid. Switch on the product to start charging the product. Refer to *Main switch on page 30*. Do not continue with any product settings before the installation is complete.

6. Put the low-voltage cable in the ground with stakes or bury the cable. Refer to *To put the wire into position with stakes on page 21* or *To bury the boundary wire or the guide wire on page 21*.
7. Connect the wires to the charging station after the installation of boundary wire and guide wire is complete. Refer to *To install the boundary wire on page 20* and *To install the guide wire on page 21*.
8. Attach the charging station to the ground with the supplied screws after the guide wire is installed. Refer to *To install the guide wire on page 21*.

### 3.5.3 To install the boundary wire



**CAUTION:** Do not put remaining wire in a coil. The coil causes interference with the product.

1. Put the boundary wire around all of the work area. Start and complete the installation behind the charging station.
2. Open the connector and put the boundary wire in the connector.

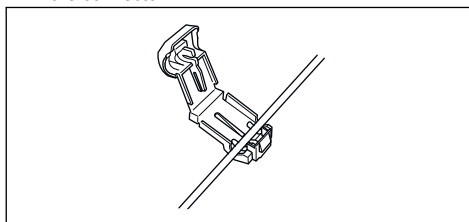

3. Close the connector with a pair of pliers.

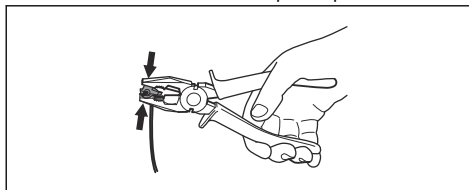

4. Cut the boundary wire 1-2 cm / 0.4-0.8 in. above each connector.
5. Push the right connector onto the metal pin on the charging station with the mark "AR".
6. Push the left connector onto the metal pin on the charging station with the mark "AL".

### 3.5.4 To install the guide wire



**CAUTION:** Twinned cables, or a screw terminal block that is insulated with insulation tape are not satisfactory splices. Soil moisture will cause the wire to oxidize and after a time result in a broken circuit.

1. Open the connector and put the wire in the connector.
2. Close the connector with a pair of pliers.
3. Cut the guide wire 1-2 cm / 0.4-0.8 in. above each connector.
4. Push the guide wire through the slot in the charging station plate.
5. Push the connector onto the metal pin on the charging station with the mark "G1", if applicable, also for "G2" and "G3".
6. Disconnect the charging station from the power outlet.
7. Put the end of the guide wire at the eyelet on the boundary wire.
8. Cut the boundary wire with a pair of wire cutters.
9. Connect the guide wire to the boundary wire with a coupler.

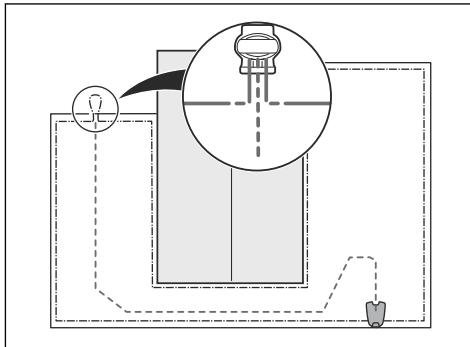

- a) Put the 2 ends of the boundary wire and the end of the guide wire into the coupler.

**Note:** Make sure that you can see the ends of the wires through the transparent area of the coupler.

- b) Push the button on the coupler with an adjustable pliers.

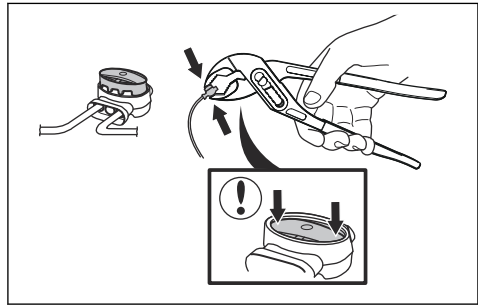

10. Attach the guide wire to the ground with stakes or bury the guide wire in the ground. Refer to *To put the wire into position with stakes on page 21* or *To bury the boundary wire or the guide wire on page 21*.
11. Connect the charging station to the power outlet.

### 3.6 To put the wire into position with stakes



**CAUTION:** Make sure that the stakes hold the boundary wire and the guide wire against the ground.



**CAUTION:** Cutting the grass too low right after installation can damage the wire insulation. Damage to the insulation may not cause disruptions until several weeks or months later.

1. Put the boundary wire and the guide wire on the ground.
2. Put the stakes at a maximum of 30 cm / 12 in. distance from each other.
3. Attach the stakes to the ground with a hammer or a plastic mallet.

**Note:** The wire is overgrown with grass and not visible after a few weeks.

### 3.7 To bury the boundary wire or the guide wire

- Cut a groove in the ground with an edge cutter or a straight shovel.
- Put the boundary wire or the guide wire 1-20 cm / 0.4-8 in. into the ground.

## 3.8 To extend the boundary wire or the guide wire

**Note:** Extend the boundary wire or the guide wire if it is too short for the work area. Use original spare parts, for example couplers.

1. Disconnect the charging station from the power outlet.
2. Cut the boundary wire or the guide wire with a pair of wire cutters where it is necessary to install the extension.
3. Add wire where it is necessary to install the extension.
4. Put the boundary wire or the guide wire into position.
5. Put the wire ends into a coupler.

**Note:** Make sure that you can see the ends of the boundary wire or the guide wire through the transparent area of the coupler.

6. Push down the cover on the coupler with adjustable pliers to attach the wires in the coupler.

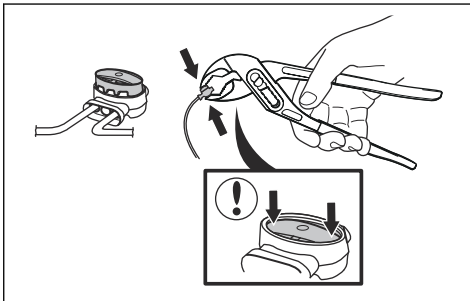

7. Put the boundary wire or the guide wire into position with stakes.
8. Connect the charging station to the power outlet.

## 3.9 After the installation of the product

### 3.9.1 To do a visual check of the charging station

1. Make sure that the indicator LED lamp on the charging station has a green light.
2. If the indicator LED lamp does not have a green light, do a check of the installation. Refer to *LED indicator lamp on the charging station on page 42* and *To install the charging station on page 19*.

### 3.9.2 To do the basic settings

When the product is switched on for the first time, there are some basic settings to do before the product can

start to operate. You must for example pair the product and the charging station, and you can choose to enable the theft protection in GeoFence. Refer to *GeoFence on page 29*. You must also pair the product and the Automower® Connect app to be able to change the settings and operate the product. Refer to *Automower® Connect on page 22*.

1. Switch on the product.

**Note:** The Bluetooth® pairing mode is active for 3 minutes. If pairing has not been successful within this time period, switch off the product. Wait until the LED status indicator is not lit, and then switch on the product again.

2. Enter the factory PIN code.
3. Log in to your Husqvarna account in the Automower® Connect app.
4. Start Bluetooth® on your mobile device.
5. Select *My mowers* in the Automower® Connect app, and then select the plus sign (+).
6. Select model. The Automower® Connect app searches for available products within short-range (Bluetooth®).
7. Select product.
8. Follow the instructions in the Automower® Connect app.

**Note:** It is only necessary to pair the Automower® Connect app and the product once.

**Note:** To disconnect the Automower® Connect app, the app must be fully closed down.

## 3.10 Automower® Connect

The app gives 2 modes of connectivity: Long-range cellular connectivity and Short-range Bluetooth® connectivity.

The product can connect to mobile devices that have the Automower® Connect app installed. Automower® Connect is a free app for your mobile device. The Automower® Connect app gives extended functions to your Husqvarna product. You can:

- See the status of your product.
- Change settings to your product.
- Get extended product information.
- Get an alarm if the product moves out of the work area.
- See statistics of your product.

---

**Note:** All countries do not support Automower® Connect because of regional specified cellular systems. The included Automower® Connect lifetime service only applies if there is a third part sub-supplier of 2G/3G/4G available in the operational area.

---

The Automower® Connect app is preferable if you have one or few products installed. For users with several products we recommend you to use Husqvarna Fleet Services™. Refer to *Husqvarna Fleet Services™ on page 29*.

### 3.10.1 To install the Automower® Connect app

1. Download the Automower® Connect app on your mobile device.
2. Sign up for a Husqvarna account in the Automower® Connect app.
3. An e-mail is sent to the registered e-mail address. Follow the instructions in the e-mail in less than 24 hours to validate your account.
4. Log in to your Husqvarna account in the Automower® Connect app.

### 3.10.2 To pair Automower® Connect and the product

1. Do step 1-7 in *To do the basic settings on page 22*.
2. Obey the instructions in the Automower® Connect app.

### 3.10.3 Dashboard

The dashboard shows the current status of the product both visually and in text. It is very easy to control the product by selecting the options, for example *Park*.

In the lower part of the dashboard there are shortcuts to the *Schedule settings* and the *Map*. The dashboard also shows symbols according to below:

1. The battery status shows the battery state of charge. A flash is shown over the battery symbol when the product charges its battery. A plug is shown over the battery symbol when the product is in the charging station without charging.
2. Cutting height.

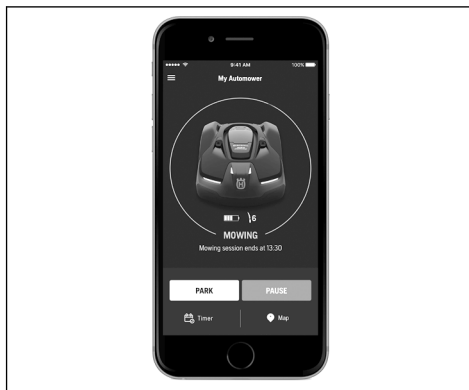

For more information about the operating modes *Start*, *Park* and *Pause*, refer to *Operation on page 30*.

### 3.10.4 Account

In this menu there is an overview of the account settings and you can log off from the app.

#### 3.10.4.1 To set the unit format

1. Select the unit format *Metric* or *Imperial*.

### 3.10.5 My mowers

When choosing *My mowers* you can manage all the products paired to your account, as well as add new ones. If there are several paired products it is possible to select one of them as *Current mower*.

To pair a new product to the Automower® Connect app:

1. Select the plus sign (+).
2. Select model.
3. Follow the instructions in the Automower® Connect app to finalize the pairing.

### 3.10.6 Automower® Direct

Automower® Direct uses short-range Bluetooth® communication, and is included in Automower® 520/550.

Automower® Direct is useful if the operator has the Automower® Connect app and the PIN code, but has not created a Husqvarna account. Automower® Direct is also useful if the connection with the product is only temporary.

Husqvarna cannot guarantee the time period or coverage of the long-range cellular connectivity. There is therefore a possibility to communicate with the product through Bluetooth® if you are in short-range of the product. You can use Automower® Direct without a Husqvarna account as long as you have the product PIN code.

**Note:** The Automower® Direct connection is only valid as long as you are within Bluetooth® range. If you move out of Bluetooth® range, you will lose the Automower® Direct connection and you must do the connection process again.

### 3.10.6.1 To start to use Automower® Direct

1. Download the Automower® Connect app on your mobile device.
2. Select Automower® Direct on the start screen of the Automower® Connect app.
3. Start Bluetooth® on your mobile device and on the product, refer to *To do the basic settings on page 22*.
4. Select the product to pair with in the Automower® Connect app.
5. Enter the PIN code for the product.

**Note:** You have access to the menus and functions as long as you are within Bluetooth® short-range.

## 3.10.7 Map

The map shows the current position of the product and the set centerpoint for GeoFence.

### 3.10.7.1 Map settings

1. Open *Map* in the main menu.
2. Select the settings symbol.
3. Enable or disable *Movement path*.
4. Enable or disable *GeoFence radius*.
5. Select *Map view* or *Satellite view*.

## 3.11 Settings in Automower® Connect

The product has factory settings but the settings can be adapted to each work area.

### 3.11.1 Schedule



In *Schedule* you can change the schedule settings for the product.

The schedule function controls which hours the product should operate and not operate. When the product is not operating it is parked in the charging station. The operating hours and days can be seen in an overview in the Automower® Connect app.

The default schedule setting allows the product to operate around the clock 7 days a week. This is normally a suitable setting for a work area corresponding to the maximum capacity. If the work area is less than the maximum capacity the schedule

should be used to minimize wear on the grass and to the product.

To calculate the schedule setting, refer to *To calculate the schedule setting on page 24*.

#### 3.11.1.1 To edit the schedule settings

1. Select *Settings > Schedule > Edit* in the app.
2. Select the pencil symbol in the app.
3. Select which days of the week and hours the product must operate.
4. Select *Save*.

#### 3.11.1.2 To add a new schedule setting

1. Select *Settings > Schedule > Edit* in the app.
2. Select the plus sign in the app.
3. Select which days of the week and hours the product must operate.
4. Select *Save*.

#### 3.11.1.3 To calculate the schedule setting

1. Calculate the dimension of your lawn in  $m^2 / ft^2$ .
2. Divide the  $m^2 / ft^2$  of the lawn with the approximate operation capacity. Refer to table below.
3. The result is equal to the number of hours that the product must operate each day.

**Note:** The operation capacity is approximate and is calculated for flat and open work area. If the work area has a lot of slopes or obstacles, you need to increase the *Schedule* settings.

Model	Approximate operation capacity, $m^2/h / ft^2 / h$
Automower® 520	92 / 990
Automower® 550	208 / 2240

Example: A lawn of  $500 m^2 / 5400 ft^2$ , cut with an Automower® 520.

$$500 m^2 / 92 \approx 5.5 h.$$

$$5400 ft^2 / 990 \approx 5.5 h.$$

Days / week	h / day	Schedule settings
7	5.5	07:00 - 12:30 / 07:00 am - 12:30 pm

### 3.11.2 Operation





In the Operation's menu it is possible to change the settings of the *Weather timer*, *ECO mode* and *Spiral cutting*.

### 3.11.2.1 Spiral cutting

If the product enters an area where it senses the grass is longer than average, it can change the movement pattern to *Spiral cutting*. This means that the product mows in a spiral pattern to faster cut the area with longer grass. It is possible to set the intensity of the *Spiral cutting*. *Very low / Low* intensity means that *Spiral cutting* begins less often. *High / Very high* intensity means that *Spiral cutting* begins more often.

**Note:** *Spiral cutting* is only started in the *Main area* mode. Cutting in the *Secondary area* mode does not let the product to start *Spiral cutting*. *Spiral Cutting* does not start in slopes steeper than 15%.

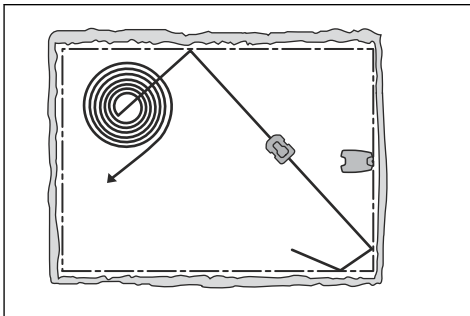

1. Select *Settings > Operation* in the app.
2. Select *On/Off* to enable or disable *Spiral cutting*.
3. Select *Settings > Spiral Cutting > Use > Intensity* to select the level of the function.
4. Select *Save*.

### 3.11.2.2 Weather timer

*Weather timer* automatically adjust the cutting time to the growth of the grass. The product is not permitted to operate more than the schedule settings.

**Note:** When using *Weather timer*, it is recommended to make as much operating time as possible available for *Weather timer*. Do not restrict the schedule more than necessary.

The first operation of the day is set by the schedule settings. The product always complete 1 mowing cycle, and then *Weather timer* selects if the product will continue to operate or not.

**Note:** *Weather timer* is reset if the product does not operate for more than 50 hours, or if a *Reset of all user*

*settings* is done. *Weather timer* is not changed if a *Reset of schedule settings* is done.

### To set the Weather timer

1. Select *Settings > Operation* in the app.
2. Select *on/off* to enable or disable the *Weather timer*.

**Note:** If the cutting results are not satisfactory, the cutting time can be adjusted. Set the cutting time *High* to cut for a longer time or *Low* to cut for a shorter time.

3. Select *Save*.

### 3.11.2.3 ECO mode

If *ECO mode* is activated, it switches off the signal in the boundary loop, the guide wire and the charging station, when the product is parked or is charging.

**Note:** Use *ECO mode* to save energy and avoid interference with other equipment, for example hearing loops or garage doors.

**Note:** To start the product manually in the work area, push the **STOP** button before you remove the product from the charging station. If not, the product can not be started in the work area.

### To set the ECO mode

1. Select *Settings > Operation* in the app.
2. Select *on/off* to enable or disable the *ECO mode* function.
3. Select *Save*.

## 3.11.3 Installation



In the Installation menu it is possible to adapt the settings of the product for best mowing result.

### 3.11.3.1 To find the charging station

The product can be set to search for the charging station in 3 methods:

- *Charging station signal*
- *Follow boundary wire*
- *Follow guide wire*

The factory setting is set to use the 3 search methods at the same time. Use the factory setting to find the charging station as fast as possible and to keep the risk of tracks on the lawn to a minimum. The product always starts to search for the *Charging station signal*. After a

specified time interval, it also uses *Follow guide* and *Follow boundary wire*.

Causes why the product cannot follow the wire:

- Obstacles near the wire have not been isolated.
- The charging station, the boundary wire or the guide wire are not installed according to the instructions in *To install the charging station on page 19*, *To install the boundary wire on page 20* and in *To install the guide wire on page 21*.

#### To change the signal range of the charging station

For some installations it is necessary to decrease the signal of the charging station. For example when the charging station is put near an obstacle such as a bush or wall and the signal reaches to the other side of the obstacle. The product knows that it is close to the charging station and tries to dock, but the objects prevents it. The options are *min*, *avg* (average) or *max*.

**Note:** The recommended setting is *max*. It is usually better to move the charging station, than to decrease the range of the charging station signal.

1. Select *Settings > Installation > Find charging station* in the app.
2. Select signal range.
3. Select *Save*.

#### To set the delay time for the guide wire and the boundary wire

1. Select *Settings > Installation > Find charging station* in the app.
2. Select *on/off* to enable or disable to follow the wire.
3. Move the horizontal bar to set the time delay.
4. Select *Save*.

#### 3.11.3.2 Lawn coverage

The product has GPS Assisted Navigation that helps the product select the most optimal operation.

Use the *Lawn coverage* function to set the settings to manual.

#### To set the GPS function

1. Select *Installation > Settings > Lawn coverage* in the app.
2. Select *on/off* to disable or enable the GPS function.

**Note:** When GPS assisted navigation is enabled it is used while there is a GPS service. The GPS assisted navigation is used even if manual settings have been made. Only when GPS service is not available, the manual settings are used.

3. Select *Save*.

#### To set the Lawn Coverage function

The *Lawn Coverage* function is used to guide the product to remote parts of the work area. If the work area includes remote parts that are connected with narrow passages, the *Lawn Coverage* function is useful to keep a well-cut lawn in all parts of the yard. You can set a maximum of 5 remote areas where the product starts to cut the lawn.

With the *Lawn Coverage* function the product first follows and then leaves the guide wire after a certain distance and starts to mow the lawn.

Area A, approximately 50%

Area B, approximately 30%

Area C, approximately 20%

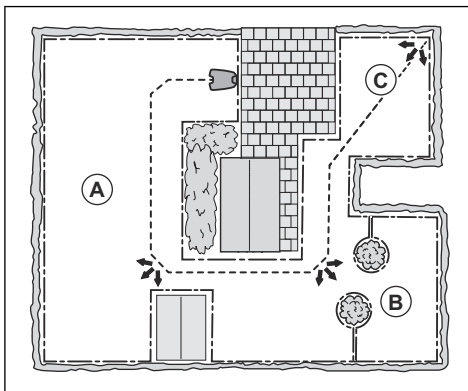

Each area can be enabled or disabled, without having to enter the settings again.

1. Select *Settings > Installation > Lawn coverage* in the app.
2. Select *on/off* to disable the GPS function to set the *Lawn Coverage*.
3. Select *on/off Area 1-5* to activate the area.
4. Move the horizontal bar to set which wire the product will follow. The product can follow *Boundary wire left*, *Boundary wire right* or one of the guide wires.
5. Move the horizontal bar to set the distance the product must follow the wire. The product then leaves the wire and starts to cut the lawn. Refer to *To measure the distance from the charging station on page 27*.
6. Move the horizontal bar to set how often the product goes to each area. At all other times, the products starts to cut near the charging station. The percentage is equal to the percentage of the area in relation to the complete work area.
  - a) Measure the area.

- b) Divide the measured area with the total work area.
- c) Convert the result to percentage.
- d) Move the horizontal bar to set the distance from the charging station.

7. Select *Save*.

The default settings lets the product follow the guide wire 300 m / 980 ft. in 20% of the times it leaves the charging station. If the guide wire is less than 300 m / 980 ft. the product will follow it to the point where the guide wire is connected to the boundary wire.

**To measure the distance from the charging station**

1. Put the product in the charging station.
2. Select *Settings > Installation > Lawn coverage* in the app.
3. Move the horizontal bar to set the distance to the charging station to maximum.
4. Select *Test: Area 1-5 setup*.
5. Follow the instructions in the app to start the test.
6. Push the **STOP** button when the product is at the distance you select to measure. The distance shows in the app.

**To do a test of the Lawn Coverage function**

1. Put the product in the charging station.
2. Select *Settings > Installation > Lawn coverage* in the app.
3. Select *Test: Area 1-5 setup*.
4. Follow the instructions in the app to start the test.
5. The product will run to the starting point for this area.

**3.11.3.3 Corridor width**

The boundary wire corridor is the area adjacent to the boundary wire and the guide corridor is the area adjacent to the guide wire. The product uses the corridors to find the charging station. When the product moves in the direction of the charging station, it always moves to the left of the guide wire.

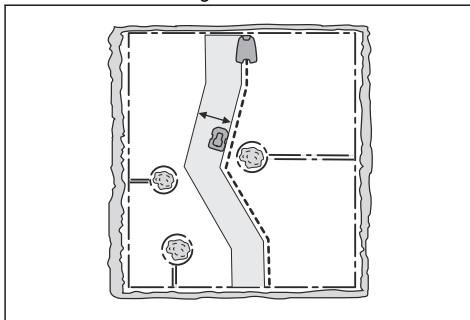

The corridor width is adjusted automatically. Only some times it is necessary to enter manual settings. The

corridor width can be set between 0-9. If guide corridor width is set to 0, the product straddles the guide wire. The factory setting is 6 for the boundary wire and 9 for the guide wire.

**To set the corridor width**

1. Select *Settings > Installation > Corridor width* in the app.
2. Move the horizontal bar to set the width.
3. Select *Save*.

**Note:** Make the corridor width as wide as possible for a minimum risk of lines in the lawn.

**3.11.3.4 Exit angles**

In the factory setting the product moves out from the charging station in a direction in the 90°-270° exit sector. Change the exit angles to make it easier for the product to find the work areas. If the charging station is put in a passage, 2 exit angles, for example 70°-110° and 250°-290°, can be used. When 2 exit angles are used, it is necessary to set how frequently the product must move out from the charging station in Sector 1. Use the Proportion function to set how frequently the product must use each sector. For example 75% means that the product moves out from the charging station in Sector 1 on 75% of the times and 25% of the times in Sector 2.

**To set the exit angles**

1. Select *Settings > Installation > Exit angles* in the app.
2. Move the horizontal bar to set the angles in degrees for the sectors, and proportion as a percentage.
3. Select *Save*.

**3.11.3.5 Reversing distance**

The reversing distance makes the product move in reverse for a set distance, before the product starts to cut the lawn. The factory setting is 60 cm / 24 ft.

**To set the reversing distance**

1. Select *Settings > Installation > Reversing distance* in the app.
2. Move the horizontal bar to set the distance.
3. Select *Save*.

**3.11.3.6 Drive Past Wire**

The front of the product always moves past the boundary wire by a specified distance before the product moves back into the work area. The factory setting for the *Drive Past Wire function* is 31 cm / 12 in. You can select a distance of 20-50 cm / 8-20 in.

**Note:** With the factory setting the product will cut 11 cm / 4 in. past the wire.

---

**Note:** If the *Drive Past Wire* distance is changed, the distance will change along the boundary wire everywhere in the work area.

---

#### To set the Drive past wire

1. Select *Settings > Installation > Drive past wire* in the app.
2. Move the horizontal bar to set the distance.
3. Select *Save*.

### 3.11.4 Accessories



Settings for accessories mounted on the product can be made in this menu.

#### 3.11.4.1 To avoid collisions with the Automower® house

When this option is enabled, the wear on the product and the Automower® house is reduced, but it can result in more uncut grass around the charging station.

1. Select *Settings > Installation > Mower house* in the app.
2. Select *on/off* to enable or disable the function.
3. Select *Save*.

#### 3.11.4.2 To set the ultrasonic

1. Select *Settings > Installation > Ultrasonic* in the app.
2. Select *on/off* to enable or disable the function.
3. Select *Save*.

### 3.11.5 General (Bluetooth® only)



This function is used to set time and date, or to reset to default settings.

#### 3.11.5.1 Time & date

The time and date can be changed manually, or by using the time and date from the mobile device.

##### To set the time & date

1. Select *Settings > General > Time & Date* in the app.
2. Select *Time & Date from phone* or select the pencil to enter the correct time and date.
3. Select *Save*.

#### 3.11.5.2 Reset to factory settings

The user settings can be reset to factory settings.

---

**Note:** *PIN code, Loop signal, Messages and Date & Time* will not be reset.

---

#### To reset to factory settings

1. Select *Settings > General > Reset* in the app.
2. Select *Reset to factory settings*.

### 3.11.6 Security (Bluetooth® only)



The security settings controls the PIN code, the GeoFence and other security functions. The correct PIN-code must be entered to get access to the *Security* menu in the Automower® Connect app.

#### 3.11.6.1 New loop signal

The loop signal is randomly selected to create a unique link between the product and the charging station. In rare cases, there may be a need to generate a new signal, for instance if 2 adjacent installations have a very similar signal.

##### To create a New loop signal

1. Put the product in the charging station.
2. Select *Security > New loop signal > Create new loop signal* in the app.
3. Select *Save*.
4. Wait for confirmation that the loop signal has been generated. This usually takes about 10 seconds.

#### 3.11.6.2 To change the PIN code

1. Select *Security > Change PIN code* in the app.
2. Enter the PIN code.
3. Enter the new PIN code.
4. Enter the new PIN code to confirm.
5. Make a note of the new PIN code in Memo. Refer to *Introduction on page 3*.

#### 3.11.6.3 Theft protection

In the *Theft Security* menu it is possible to set the alarm duration and also what events should trigger the alarm. The factory setting is to require PIN code and the alarm duration is 1 min.

##### Time lock

The time lock can be set between 1 to 100 days. The factory setting is 30 days. When the selected number of days has gone by, the product continues to operate as usual. To enter new settings the PIN code must be entered.

### Require PIN code

This function means that the product cannot be operated or controlled after the **STOP** button has been pushed without first entering the correct PIN code. If the incorrect PIN code is entered 5 times, the product is locked for a time. The lock is extended for each new incorrect try.

### Alarm duration

There is a possibility to set how long the alarm signal should last. A setting between 1 and 10 minutes is possible.

### STOP button pressed

If the alarm "*STOP button pressed*" is enabled, the alarm goes off if someone presses the **STOP** button and the PIN code is not entered within 30 seconds.

### Carried away

If the alarm *Carried away* is enabled, the product senses unexpected motions, and the alarm goes off.

### To set the Theft protection

1. Select *Settings > Security > Theft protection* in the app.
2. Select the on/off button to enable or disable the *Time lock, Require PIN code, STOP button pressed* and *Carried away*.
3. Move the horizontal bar to select the duration of the alarm.

### 3.11.6.4 GeoFence

GeoFence is a GPS-based theft protection that makes a virtual fence for the product. If the product is more than a set distance away from the center position the product will be deactivated and an alarm will start. The PIN code is needed to deactivate the alarm and to start the product again.

### To set the center position and radius for the GeoFence function

1. Select *Settings > Security > GeoFence* in the app.
2. Put the product in a central position of the work area.
3. Select the on/off button to enable or disable the GeoFence function. The center position will be set to the current position of the product.
4. Use the horizontal bar to set the radius.

### 3.11.7 Automower® Connect (Bluetooth® only)



In *Automower® Connect* you can enable or disable the Automower® Connect module. You can also see the signal strength, connectivity status, initiate new pairing or remove the product from the paired accounts.

### 3.11.8 Messages (Bluetooth® only)

In this menu the previous fault and information messages can be found. For some of the messages, there are tips and advice to help to rectify the fault.

---

**Note:** The *Messages* menu is only available for Bluetooth® short-range connectivity.

---

If the product is disrupted in any way, for example it is trapped or the battery is low, a message is saved relating to the disruption and the time it happened.

If the same message is repeated several times, this may indicate that an adjustment to the installation or the product is required. Refer to *Installation on page 14*.

### 3.11.9 Husqvarna Fleet Services™

Husqvarna Fleet Services™ is a cloud solution that gives the commercial fleet manager an overview of all products. It also gives the fleet manager the possibility to control all products remotely. Husqvarna Fleet Services™ is included for Automower® 520/550. For more information about Husqvarna Fleet Services™, refer to [www.husqvarna.com](http://www.husqvarna.com).

### 3.11.9.1 To connect to the product with Husqvarna Fleet Services™

1. Download the Husqvarna Fleet Services™ app and Automower® Connect app to your mobile device.
2. Create a Husqvarna Fleet Services™ account ([www.husqvarna.com](http://www.husqvarna.com)).
3. Log on to the Husqvarna Fleet Services™ app.
4. Set the **Main switch** on the product to position *1*.

---

**Note:** The Bluetooth® pairing mode is active for 3 minutes. If pairing has not been successful within this time period, switch off the product. Wait until the LED status indicator is not lit, and then switch on the product again.

---

5. Select the plus sign (+) in the Husqvarna Fleet Services™ app.
  6. Select *Automower®* and then *Automower® Pro*. The Husqvarna Fleet Services™ app searches for available products within short-range (Bluetooth®).
  7. Select product.
  8. Select *Acquire pairing code* to connect the product to your Husqvarna Fleet Services™ account.
  9. Obey the instructions in the Husqvarna Fleet Services™ app.
- 

**Note:** It is only necessary to pair Husqvarna Fleet Services™ app and the product once.

---

## 4 Operation

### 4.1 Main switch



**WARNING:** Read the safety instructions carefully before you start the product.



**WARNING:** Keep your hands and feet away from the rotating blades. Do not put your hands or feet near to or below the product when the cutting motor is on.



**WARNING:** Do not use the product when persons, especially children, or animals are in the work area.

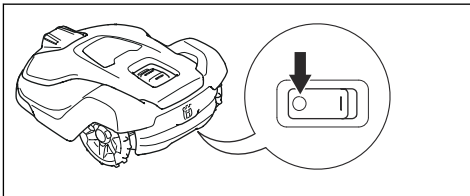

- Set the **Main switch** in the *1* position to start the product.
- Set the **Main switch** in the *0* position when the product is not in use or before you do inspection or maintenance on the product.

### 4.2 Start

1. Set the **Main switch** to position *1*.
2. Open the Automower® Connect app.
3. Select the *Dashboard*.
4. Select *Start* in the Automower® Connect app.

If the product is parked in the charging station, it will only leave the charging station when the battery is fully charged and if the schedule is set to allow the product to operate.

**Note:** Make sure that the **START** button on top of the product is in the correct position. The product does not start if the **STOP** button is activated.

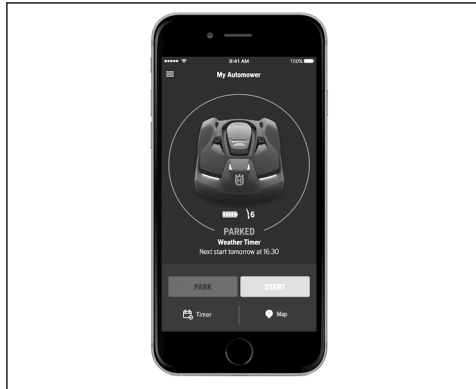

### 4.3 Operating mode - Start

When *Start* has been selected the following operation selections can be selected.

- Main area
- Override schedule
- Secondary area

#### 4.3.1 Main area

*Main area* is the standard work mode where the product cuts grass and charges automatically.

1. Open the Automower® Connect app.
2. Select *Dashboard* in the Main menu.
3. Select *Start*
4. Select *Resume on main area* to start the product.

#### 4.3.2 Override schedule

Any schedule settings can be temporarily overridden by selecting *Override schedule*.

1. Select *Dashboard* in the Main menu.
2. Select *Start*.
3. Slide the horizontal bar of *Override schedule* to find a suitable override duration. It is possible to override the schedule up to 7 days.
4. Select a suitable override duration.

#### 4.3.3 Secondary area

To mow secondary areas the operating mode *Secondary area* must be selected. In this mode, the operator must move the product manually between the main area and the secondary area. The product mows for a selected period of time or until the battery is empty. When the battery is empty the product stops. Put the product in the charging station to charge the battery. When the battery is charged, the product moves out of the charging station and stops. The product is now

prepared to start operation, but needs confirmation from the operator first. In the *Secondary area* mode, the product operates for a selected period of time or until the battery is empty.

**Note:** If you want to cut the main area after the battery is charged, set the product to *Main area* mode before you put the product in the charging station.

## 4.4 Operating mode - Park

When selecting *Park* the following operation selections can be chosen.

- Park until further notice
- Start with schedule
- Parking duration

### 4.4.1 Park until further notice

The operation mode *Park* means that the product goes back to the charging station where it stays until a new operation mode is selected and the **START** button is pushed.

### 4.4.2 Start on next schedule

The product goes back to the charging station where it stays until the next schedule setting let the product to operate. Use the operation selection to stop operation temporary, for example for irrigation or for games on the lawn.

### 4.4.3 Parking duration

The product goes back to the charging station and stays for the selected park duration. Use the operation selection to temporary stop an ongoing mowing cycle and let the product to stay in the charging station.

### 4.4.4 The charging station's park button

The **PARK** button on the charging station is used to call the product back to the charging station. *Park* in the Automower® Connect app offers the same function. The **PARK** button on the charging station is useful for instance when the product operates in a large work area and the operator does not have access to the Automower® Connect app.

An LED in the **PARK** button is lit when the button has been pressed. The LED diode goes out when the product is parked in the charging station.

The product stays in the charging station until *Start* in the Automower® Connect app is activated.



### 4.4.5 Operating mode - Pause

When selecting *Pause* in the Automower® Connect app, the product stop the current activity and pause. The product is paused until either *Park* or *Start* is selected in the Automower® Connect app.

## 4.5 To stop the product

1. Push the **STOP** button on top of the product.

The product stops and the cutting motor stops.

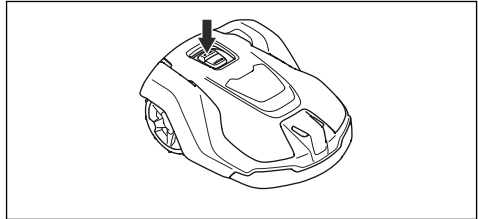

## 4.6 To switch off the product

1. Press the **STOP** button on top of the product.
2. Set the **Main switch** to position 0.

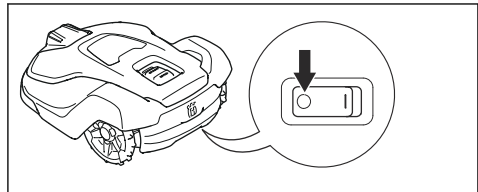

**WARNING:** Always switch off the product using the main switch if it requires maintenance, or if the product must be moved outside the work area.

## 4.7 To adjust the cutting height with Automower® Connect

The cutting height can be varied from MIN (2 cm / 0.8 in.) to MAX (6 cm / 2.5 in.).

---

**Note:** During the first weeks after a new installation, the cutting height must be set to MAX to avoid damaging the loop wire. After this, the cutting height can be lowered step by step every week until the desired cutting height has been reached.

---

1. Select *Settings > Cutting height*.
2. Move the horizontal bar to set the cutting height.
3. Select *Save*.

## 4.8 To charge the battery

---



**WARNING:** Only charge the product using a charging station which is intended for it. Incorrect use may result in electric shock, overheating or leakage of corrosive liquid from the battery.

In the event of leakage of electrolyte flush with water and seek medical help if it comes in contact with the eyes etc.

---

When the product is new or has been in storage for a long period, the battery can be empty, charge the battery before you start the product.

1. Set the **Main switch** to position *1*.
2. Put the product in as far as possible in the charging station. Make sure that the product and the charging station is connected. Refer to contact and charging strips in *Product overview on page 4*.
3. Make sure that the charging is in progress in the Automower® Connect app.



---

## 5 Maintenance

---

### 5.1 Introduction - maintenance



**WARNING:** The product must be switched off before any maintenance is done. The product is disabled when the **Main switch** is in position 0.



**WARNING:** Wear protective gloves.

For better operation and longer service life, make sure to clean the product regularly and replace worn parts. All maintenance and servicing must be done according to Husqvarna's instructions. Refer to *Warranty on page 51*.

When the product is first used, the blade disc and blades should be inspected once a week. If the amount of wear during this period has been low, the inspection interval can be increased.

It is important that the blade disc rotates easily. The edges of the blades should not be damaged. The lifetime of the blades varies immensely and depends for instance on:

- Operating time and size of the work area.
- Type of grass and seasonal growth.
- Soil, sand and use of fertilizers.
- The presence of objects such as cones, windfalls, toys, tools, stones, roots and the like.

The normal life is 2 to 5 weeks when used under favorable conditions. Refer to *Replace the blades on page 34* on how to replace the blades.

**Note:** Working with blunt blades gives a poorer mowing result. The grass is not cut cleanly and more energy is needed resulting in the product not mowing such a large area.

### 5.2 Clean the product

It is important to keep the product clean. A product with large amounts of grass stuck to it will not cope as well with slopes. It is recommended to clean using a brush.

Husqvarna recommends to use a special cleaning and maintenance kit, available as an accessory. Contact your Husqvarna representative for more information.



**CAUTION:** Never use a high-pressure washer to clean the product. Never use solvents for cleaning.

### 5.2.1 Chassis and blade disc

Inspect the blade disc and blades once a week.

1. Set the **Main switch** to position 0.
2. Lift the product onto its side.
3. Clean the blade disc and chassis using for example a dish brush. At the same time, check that the blade disc rotates freely in relation to the foot guard. Also, check that the blades are intact and can pivot freely.

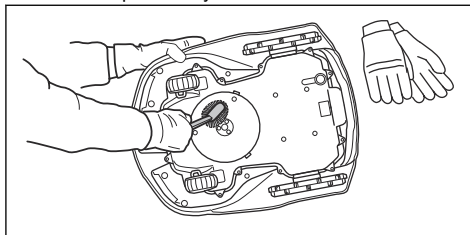

### 5.2.2 Chassis

Clean the underside of the chassis. Brush or wipe with a damp cloth.

### 5.2.3 Wheels

Clean around the wheels. Grass on the wheels can impact on how the product performs in slopes.

### 5.2.4 The body of the product

Use a moist, soft sponge or cloth to clean the body of the product. If the body of the product is dirty, use a mild soap solution to clean it.

### 5.2.5 Charging station



**WARNING:** Disconnect the power supply from the power outlet before any maintenance, or cleaning of charging station or power supply.

Clean the charging station regularly from grass, leaves, twigs and other objects that may impede docking.

## 5.3 Replace the blades



**WARNING:** Use blades and screws of the right type. Husqvarna can only guarantee safety when using original blades. Only replacing the blades and reusing the screw can result in a screw wearing during mowing. The blades can then be propelled from under the body and cause serious injury.

Replace worn or damaged parts for safety reasons. Even if the blades are intact, they should be replaced on a regular basis for the best mowing result and low energy usage. All 3 blades and screws must be replaced at the same time to obtain a balanced cutting system. Use Husqvarna original blades embossed with the crowned H-mark logotype, refer to *Technical data on page 48*.

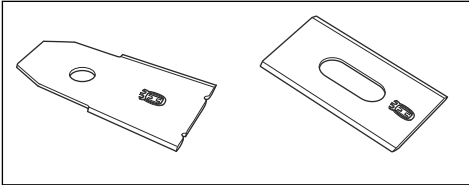

### 5.3.1 To replace the blades

1. Push the **STOP** button
2. Set the **Main switch** to position 0.

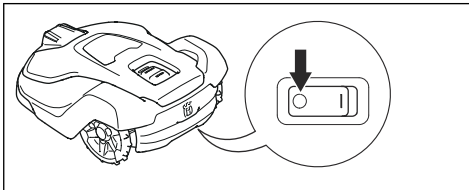

3. Turn the product upside down. Put the product on a soft and clean surface to avoid scratching the product.
4. Rotate the skid plate so that its holes align with the screws for the blade.
5. Remove the 3 screws with a screwdriver.

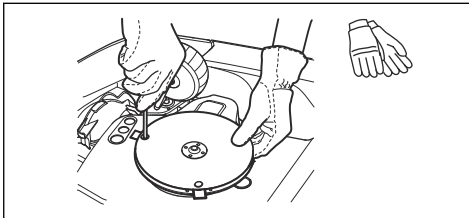

6. Remove the 3 blades.

7. Attach 3 new blades and screws.
8. Make sure that the blades can pivot freely.

## 5.4 Battery



**WARNING:** Only charge the product using a charging station which is intended for it. Incorrect use may result in electric shock, overheating or leakage of corrosive liquid from the battery. In the event of leakage of electrolyte flush with water and seek medical help if it comes in contact with the eyes etc.



**WARNING:** Use only original batteries recommended by the manufacturer. Product safety cannot be guaranteed with other batteries. Do not use non-rechargeable batteries.



**CAUTION:** The battery must charge a complete cycle before winter storage. If the battery is not fully charged it can be damaged and in certain cases be rendered useless.

If the operating time for the product is shorter than normal between charges, this indicates that the battery is getting old and eventually needs replacing.

**Note:** Battery life is dependent on the length of the season and how many hours a day the product is operating. A long season or many hours of use a day means that the battery must be replaced more regularly. The battery is fine as long as the product maintains a well-cut lawn.

## 5.5 Winter service

Take your product to your Husqvarna central service for service prior to winter storage. Regular winter service will maintain the product in good condition and create the best conditions for a new season without any disruptions.

Service usually includes the following:

- Thorough cleaning of the body, the chassis, the blade disc and all other moving parts.
- Testing of the product's function and components.
- Checking and, if required, replacing wear items such as blades and bearings.
- Testing the product's battery capacity as well as a recommendation to replace battery if necessary.
- If new firmware is available, the product is updated.

---

## 6 Troubleshooting

---

### 6.1 Introduction - troubleshooting

All messages can be found in the *Messages* menu in Automower® Connect. More suggestions for steps to take in the event of malfunction or symptoms can be found on [www.husqvarna.com](http://www.husqvarna.com).

---

**Note:** The *Messages* menu is only available for short-range connectivity (Bluetooth®).

---

### 6.2 Fault messages

The list below shows a number of fault messages that may be shown in the app. Speak to your local Husqvarna representative if the same message shows frequently.

Message	Cause	Action
<i>Wheel motor blocked</i>	Grass or other objects is wound around the drive wheel.	Examine the drive wheel and remove the grass or other object.
<i>Cutting system blocked</i>	Grass or other objects is wound around the blade disc.	Examine the drive wheel and remove the grass or other object.
	The blade disc are in a pool of water.	Move the product and prevent the collection of water in the work area.
<i>Cutting height blocked</i>	Grass or other objects is wound around the cutting height adjustment, or between the blade disc and chassis.	Examine the blade disc and the bellows around the cutting height adjustment, and remove any grass or other objects that may have got stuck.
<i>Trapped</i>	The product is blocked in a small area behind a number of obstacles.	Examine if there are obstacles which make it hard for the product to move away from this location.

<b>Message</b>	<b>Cause</b>	<b>Action</b>
<i>No loop signal</i>	The power supply or the low-voltage cable is not connected.	Examine the LED status on the charging station. If there is no power to the charging station, the LED is not lit. Examine the power outlet connection and if a residual-current device is engaged. Make sure that the low-voltage cable is connected to the charging station.
	The power supply or the low-voltage cable is damaged.	Replace the power supply or low-voltage cable.
	The boundary wire is not connected to the charging station.	Make sure that the boundary wire connectors are fitted properly to the charging station. Replace connectors if damaged. Refer to <i>To install the boundary wire on page 20</i> .
	Boundary wire broken.	Examine the LED on the charging station. If the LED indicates that there is a break in the boundary wire, find out where the break is. Replace the damaged section of the loop with a new loop wire. Use an original coupler to make a splice of the loop ends. Refer to <i>Finding breaks in the loop wire on page 44</i> .
	<i>ECO mode</i> is activated and the product has attempted to start outside the charging station.	Put the product in the charging station. Start the product. Refer to <i>Start on page 30</i> .
	The boundary wire is crossed on its way to and from an island.	Make sure that the boundary wire is put down correctly. Refer to <i>To install the boundary wire on page 20</i> .
	The product does not find the loop signal from the charging station.	Put the product in the charging station and generate a new loop signal. Refer to <i>New loop signal on page 28</i> .
	Disturbances from metal objects (fences, reinforcement steel) or buried cables close by.	Try to move the boundary wire and/or make more islands in the work area to increase the signal strength.
	The product is too far from the boundary wire.	Redo the installation of the boundary wire so that all parts of the work area is maximum 35 m / 115 ft. from the boundary wire.
<i>Wrong PIN code</i>	An incorrect PIN code has been entered. 5 tries are permitted, and the product is then blocked for a period of time.	Enter the correct PIN code. Speak to your local Husqvarna representative if you forget the PIN code.

<b>Message</b>	<b>Cause</b>	<b>Action</b>
<i>Outside work area</i>	The boundary wire connections to the charging station are crossed.	Make sure that the boundary wire is connected correctly to the charging station. Refer to <i>To install the boundary wire on page 20</i> .
	The boundary wire is too close to the edge of the work area.	Make sure that the boundary wire is put down correctly. Refer to <i>To install the boundary wire on page 20</i> .
	The work area slopes too much by the boundary loop.	
	The boundary wire is laid in the wrong direction around an island.	
	Disturbances from metal objects (fences, reinforcement steel) or buried cables close by.	Try to move the boundary wire and/or make more islands in the work area to increase the signal strength.
	The product finds it hard to distinguish the signal from another product installation close by.	Put the product in the charging station and generate a new loop signal. Refer to <i>New loop signal on page 28</i> .
<i>Empty battery</i>	The product cannot find the charging station.	Change the position of the guide wire. Refer to <i>To examine where to put the guide wire on page 18</i> .
		Check the installation settings about how to find the charging station. Refer to <i>To find the charging station on page 25</i> .
	The battery is spent.	Replace the battery. Refer to <i>Battery on page 34</i> .
	The charging station's antenna is defective.	Check if the indicator lamp in the charging station flashes red. Refer to <i>LED indicator lamp on the charging station on page 42</i> . This problem requires action by authorized service technician.
<i>No drive</i>	The product has hit an obstacle and stopped or the wheels cannot move on the wet grass.	Free the product and rectify the reason for the lack of drive. If it is due to wet grass, wait until the lawn has dried before using the product.
	The work area includes a steep slope.	Maximum guaranteed slope is 45%. Steeper slopes should be isolated. Refer to <i>To put the boundary wire in a slope on page 16</i> .
	The guide wire is not laid at an angle on a slope.	If the guide wire is laid on a slope, it must be laid at an angle across the slope. Refer to <i>To examine where to put the guide wire on page 18</i> .
<i>Wheel motor overloaded</i>	Grass or other objects is wound around the drive wheel.	Examine the drive wheel and remove grass or other objects.

<b>Message</b>	<b>Cause</b>	<b>Action</b>
<i>Charging station blocked</i>	The contact between the charging strips and contact strips may be poor and the product has made a number of attempts to charge.	Put the product in the charging station and check that the charging plates and contact plates make good contact.
	An object is obstructing the product.	Remove the object.
	The charging station is tilted or bent.	Confirm that the charging station is placed on a fully flat and horizontal ground. The charging station must not be tilted or bent.
<i>Stuck in charging station</i>	The product slips on the baseplate.	Clean the baseplate.
	There is an object in the way of the product preventing it from leaving the charging station.	Remove the object.
<i>Upside down</i>	The product is leaning too much or has turned over.	Turn the product the right way up.
<i>Mower tilted</i>	The product is tilted more than the maximum angle.	Move the product to a flat area.
<i>Needs manual charging</i>	The product is set to the <i>Secondary area</i> operating mode.	Place the product in the charging station. This behavior is normal and no action is required.
<i>Next start hh:mm</i>	The schedule setting prevents the product from operating.	Change the schedule settings. Refer to <i>Schedule on page 24</i> .
	The clock on the product is not correct.	Set the time. Refer to <i>Time &amp; date on page 28</i> .
<i>Lifted</i>	The lift sensor is engaged because the product hit an object or/and is blocked.	Free the product. If the problem stays, speak to your approved servicing dealer.
<i>Collision sensor problem, front/rear</i>	The body of the product can not move freely around its chassis.	Remove dirt or objects between the chassis and the body to make sure that the body can move freely around the chassis.
	The product has become stuck.	Free the product and rectify the reason.
<i>Wheel motor blocked right/left</i>	Grass or other object is wrapped around the drive wheel.	Clean the wheels and around the wheels.
<i>Alarm! Mower switched off</i>	The alarm was activated because the product was switched OFF.	Adjust the mower security settings in the <i>Security</i> menu. Refer to <i>Security (Bluetooth® only) on page 28</i> .
<i>Alarm! Mower stopped</i>	The alarm was activated because the product was stopped.	
<i>Alarm! Mower lifted</i>	The alarm was activated because the product was lifted.	
<i>Alarm! Mower tilted</i>	The alarm was activated because the product was tilted.	
	The product is tilted more than the maximum angle.	Move the product to a flat area.

<b>Message</b>	<b>Cause</b>	<b>Action</b>
<i>Electronic problem</i>	Temporary electronic or firmware related issue in the product.	Restart the product.  If the problem stays, speak to your approved servicing dealer.
<i>Loop sensor problem, front/rear</i>		
<i>Charging system problem</i>		
<i>Tilt sensor problem</i>		
<i>Temporary problem</i>		
<i>Wheel drive problem, right/left</i>		
<i>Invalid device combination</i>		
<i>Ultrasonic problem</i>		
<i>GPS navigation problem</i>		
<i>Temporary battery problem</i>		
<i>Faulty mix of batteries</i>		
<i>Battery problem</i>	Temporary battery or firmware related issue in the product.	Restart the product.  If the problem stays, speak to your approved servicing dealer.
	Wrong type of battery	Use only original batteries recommended by the manufacturer.
<i>Battery temperature outside limits</i>	The product does not operate if the battery temperature is too high or too low.	The product starts to operate again when the temperature is between the set limits and the schedule settings let the product to operate. Make sure that the charging station is put in an area with protection from the sun.
<i>Charging current too high</i>	Wrong or faulty power supply unit.	Restart the product.  If the problem stays, speak to your approved servicing dealer.
<i>Connectivity problem</i>	Potential problem on the connectivity circuit board in the product.	Restart the product.  If the problem stays, speak to your approved servicing dealer.

## 6.3 Information messages

The list below shows a number of information messages that may be found in the *Messages* menu in the Automower® Connect app. Contact your local Husqvarna representative if the same message appears often.

Message	Cause	Action
<i>Low battery</i>	The product cannot find the charging station.	Change the position of the guide wire. Refer to <i>To examine where to put the guide wire on page 18</i> . Make sure that the installation settings about how to find the charging station is correct. Refer to <i>Battery on page 34</i> .
	The battery is spent.	Replace the battery. Refer to <i>Battery on page 34</i> .
	The charging station's antenna is defective.	Check if the indicator lamp in the charging station flashes red. Refer to <i>LED indicator lamp on the charging station on page 42</i> . This problem requires action by authorized service technician.
<i>Settings restored</i>	Confirmation that a <i>Reset all user settings</i> has been carried out.	This is normal. No action required.
<i>Limited cutting height</i>	The cutting height adjustment cannot move.	Examine the cutting height adjustment and remove grass or other objects. If the problem stays, speak to your approved servicing dealer.
<i>Unexpected cutting height adj</i>		
<i>Limited cutting height range</i>		
<i>Cutting height problem</i>		
<i>Cutting height blocked</i>		
<i>Cutting system imbalance</i>	The product has discovered vibrations in the blade disc.	Verify that the blades and screws are intact and not worn out. Verify that all blades are correctly mounted. Check that no double blades are mounted on any of the three blade positions.
<i>Slope too steep</i>	The product stopped because the slope is too steep.	Change the installation of the boundary wire to not include this steep part of the work area. Refer to <i>To install the boundary wire on page 20</i> .
<i>Guide 1 not found</i> <i>Guide 2 not found</i> <i>Guide 3 not found</i>	The guide wire is not connected to the charging station.	Check that the guide wire's connector is tightly connected to the charging station. Refer to <i>To install the guide wire on page 21</i> .
	Break in the guide wire.	Find out where the break is. Replace the damaged section of the guide wire with a new loop wire and splice using an original coupler.
	The guide wire is not connected to the boundary loop.	Check that the guide wire is connected correctly to the boundary loop. Refer to <i>To install the guide wire on page 21</i> .



<b>Message</b>	<b>Cause</b>	<b>Action</b>
<i>Guide calibration failed</i>	The product has failed to calibrate the guide wire.	Check that the guide wires are installed according to the instructions. Refer to <i>To install the guide wire on page 21</i> . The next time the product moves out from the charging station, a new guide calibration is done.
<i>Guide calibration accomplished</i>	The product has succeeded to calibrate the guide wire.	No action required.
<i>GPS navigation problem</i>	Problem with the GPS assisted navigation equipment.	Contact your local Husqvarna representative if this message appears often.
<i>Weak GPS signal</i>	The sky is blocked in large parts of the work area.	If possible, remove objects that can cause a blockage of the GPS signal.
		Disable the GPS navigation function and use the lawn coverage function. Refer to <i>Lawn coverage on page 26</i> .
<i>Difficult finding home</i>	The product has been following the boundary wire several laps without finding the charging station.	The installation has not been done correctly. Refer to <i>Installation on page 14</i> .
		Wrong corridor width setting on boundary wire. Refer to <i>Corridor width on page 27</i> .
		The product was started on a Secondary area with the Main area setting.
<i>Temporary problem with the server.</i>	Please try again.	Contact your local Husqvarna representative if this message appears often.
<i>Connection problems</i>	Problem with the Automower® Connect module	Restart the product. If there still is a connection problem, try to unpair the product ( <i>My mowers</i> ) and then pair it again. If the problem remains, contact your local Husqvarna representative.
<i>Connection settings restored</i>	Settings for wireless connectivity have been restored due to an error.	Check and revise settings if necessary.
<i>SIM card requires PIN</i>	The SIM card must be unlocked.	Make sure the correct SIM PIN has been entered into the mower's menu (Network > SIM card). Contact your local Husqvarna representative if this message appears often.
<i>SIM card locked</i>	The SIM card must be replaced.	Contact your local Husqvarna representative.
<i>SIM card not found</i>	Automower® Connect requires a SIM card to be inserted in the mower.	Contact your local Husqvarna representative.
<i>GeoFence problem</i>	The GeoFence is not work due to poor (or no) communication with the system.	Contact your local Husqvarna representative.

## 6.4 LED indicator lamp on the charging station

For a fully functional installation, the indicator lamp in the charging station must emit a solid or flashing green light. If any other color than green is visible, follow the troubleshooting guide below.

There is more help on [www.husqvarna.com](http://www.husqvarna.com). If you still need help, please contact your local Husqvarna representative.

Light	Cause	Action
Green solid light	Good signals	No action required
Green flashing light	The signals are good and <i>ECO mode</i> is activated.	No action required. For more information on <i>ECO mode</i> . Refer to <i>ECO mode on page 25</i> .
Blue flashing light	The boundary loop is not connected to the charging station.	Check that the boundary wire connectors are fitted properly to the charging station. Refer to <i>To install the boundary wire on page 20</i> .
	Break in the boundary loop.	Find out where the break is. Replace the damaged section of the loop with a new loop wire and splice using an original coupler.
Red flashing light	Interruption in the charging station's antenna.	Contact your local Husqvarna representative.
Red solid light	Fault in the circuit board or incorrect power supply in the charging station. The fault should be rectified by an authorized service technician.	Contact your local Husqvarna representative.

## 6.5 LED indicator lamp on the product

There is a LED indicator lamp on top of the product, which shows the current status:

Light	Cause	Action
Green solid light	The product is either mowing the lawn, or leaving the charging station.	No action required.
Blue solid light	The product is either paused, parked, charging or is searching for the charging station.	No action required.
Yellow solid light	The <b>STOP</b> button has been pressed.	Press the <b>START</b> button on top of the product to start it again.
Red solid light	The product has stopped due to an error.	Clear the error by pressing the <b>STOP</b> button, and then activate the product by pressing the <b>START</b> button on top of the product.
Yellow flashing light	The product requests the PIN code.	The PIN code needs to be confirmed in the Automower® Connect app before the product can be activated.

There is more help on [www.husqvarna.com](http://www.husqvarna.com). If you still need help, please contact your local Husqvarna representative.

## 6.6 Symptoms

If your product does not work as expected, follow the symptoms guide below.

There is a FAQ (Frequently Asked Questions) on [www.husqvarna.com](http://www.husqvarna.com) which provides more detailed answers to a number of standard questions. Contact your local Husqvarna representative if you still cannot find the reason for the fault.

Symptoms	Cause	Action
The product has difficulty docking.	The boundary wire is not laid in a long straight line that is far enough out from the charging station.	Check that the charging station has been installed correctly. Refer to <i>To install the charging station on page 19</i>
	The charging station is on a slope.	Place the charging station on a surface that is entirely level. Refer to <i>To examine where to put the charging station on page 14</i> .
The product runs at the wrong time	The product clock needs to be set.	Set the clock. Refer to <i>Time &amp; date on page 28</i> .
	The start and stop times for mowing are incorrect.	Reset the start time and stop time settings for mowing. Refer to <i>Schedule on page 24</i> .
The product vibrates.	Damaged blades lead to imbalance in the cutting system.	Inspect the blades and screws and replace them if necessary. Refer to <i>To replace the blades on page 34</i> .
	Too many blades in the same position lead to imbalance in the cutting system.	Check that only one blade is fitted at each screw.
	Different versions (thickness) of Husqvarna blades are used.	Check if the blades are of different versions.
The product runs, but the blade disc does not rotate.	The product searches for the charging station.	No action. The blade disc does not rotate when the product is searching for the charging station.
The product mows for shorter periods than usual between charges.	Grass or other foreign object blocks the blade disc.	Remove and clean the blade disc. Refer to <i>Chassis and blade disc on page 33</i> .
	The battery is spent.	Replace the battery. Refer to <i>Battery on page 34</i> .
Both the mowing and charging times are shorter than usual.	The battery is spent.	Replace the battery. Refer to <i>Battery on page 34</i> .
The product is parked for hours in the charging station.	The product is parked due to a schedule setting, or because <i>Park until further notice</i> has been chosen in the app.	Open the app and edit the schedule settings, or go to <i>Dashboard</i> and start the product.
	The product does not operate if the battery temperature is too high or too low.	The product starts to operate again when the temperature is between the set limits and the schedule settings let the product to operate. Make sure that the charging station is put in an area with protection from the sun.
The product often moves in circles or spirals.	Spiral cutting is a natural part of the product's movement patter.	Adjust the intensity of spiral cutting. This function can be disabled if necessary. Refer to <i>Spiral cutting on page 25</i> .

Symptoms	Cause	Action
The product turns round and stays on a small area for several minutes.	This is completely normal for the product. The product have GPS assisted navigation that contributes to an even result.	No action.
Uneven mowing results.	The product works too few hours per day.	Increase the mowing time. Refer to <i>Schedule on page 24</i> .  The <i>Weather timer</i> senses that the lawn has been mowed more than it actually has. Increase the intensity level in the <i>Weather timer</i> . Disable the <i>Weather timer</i> if this does not help.
	The settings for the <i>Lawn coverage</i> function are incorrect in relation to the layout of the work area. <b>Note:</b> Not applicable if GPS assisted navigation is enabled.	Do a check of the settings for the <i>Lawn coverage</i> function. Refer to <i>Lawn coverage on page 26</i> .Lawn coverage.
	The shape of the work area requires the use of <i>Area 1-5</i> for the product to find its way to all remote areas. <b>Note:</b> Not applicable if GPS assisted navigation is enabled.	Use <i>Area 1-5</i> to steer the product to a remote area. Refer to <i>Lawn coverage on page 26</i> .
	Work area is too large.	Try to limit the work area, or to extend the work time. Refer to <i>To calculate the schedule setting on page 24</i> .
	Dull blades.	Replace all the blades. Refer to <i>Replace the blades on page 34</i> .
	Long grass in relation to the set cutting height.	Increase the cutting height and then successively lower it.
	Accumulation of grass by the blade disc or around the motor shaft.	Check that the blade disc rotates freely and easily. If not, screw off the blade disc and remove grass and foreign objects. Refer to <i>Chassis and blade disc on page 33</i> .

## 6.7 Finding breaks in the loop wire

Breaks in the loop wire are usually the result of unintentional physical damage to the wire such as when gardening with a shovel. In countries with ground frost, also sharp stones that move in the ground can damage the wire. Breaks can also occur due to the wire being stretched excessively during installation.

Mowing the grass too low right after the installation can damage wire insulation. Damage to the insulation may not cause disruptions until several weeks or months later.



**CAUTION:** Always select the maximum cutting height the first weeks after installation and then lower the height one step at a time every second week until the desired cutting height has been reached.

A defective splicing of the loop wire can also lead to disruptions several weeks after the splice was done. A

faulty splice can, for example, be the result of the coupler not being pressed together hard enough with a pair of pliers, or that a coupler of lower quality than the original coupler has been used.

**Note:** Please first check all known splices before further troubleshooting is done.

A wire break can be located by gradually halving the distance of the loop where the break may have occurred until there is only a very short section of the wire left.

The following method does not work if *ECO mode* is activated. Make sure first that *ECO mode* is turned off. Refer to *ECO mode on page 25*.

1. Check that the indicator lamp in the charging station flashes blue, which indicates a break in the boundary loop. Refer to *LED indicator lamp on the charging station on page 42*.

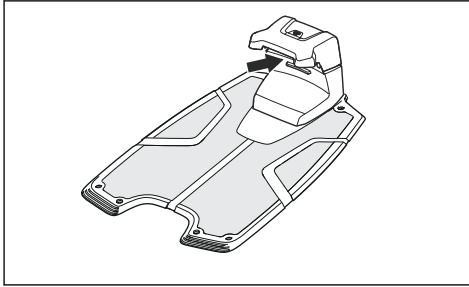

2. Check that the boundary wire connections to the charging station are properly connected and not damaged. Check that the indicator lamp in the charging station is still flashing blue.

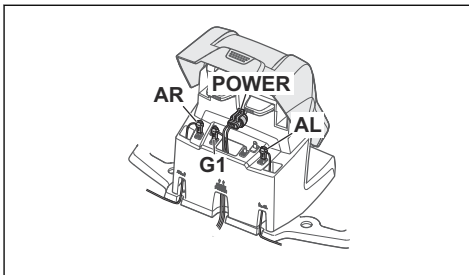

3. Switch the connections between the guide wire and the boundary wire in the charging station.

Start by switching connection AL and G1. Some models have additional guide wires. The same procedure can be followed for them.

If the indicator lamp is lit with a solid green light, then the break is somewhere on the boundary wire between AL and the point where the guide wire is connected to the boundary wire (thick black line in the illustration).

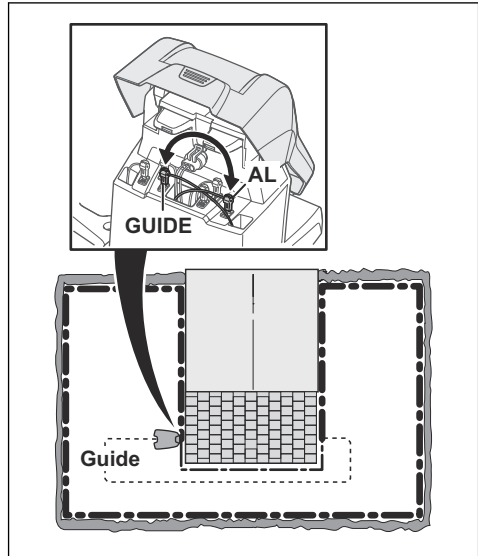

To rectify the fault you will need boundary wire, connector(s) and coupler(s):

- a) If the suspected boundary wire is short then it is easiest to exchange all of the boundary wire between AL and the point where the guide wire is connected to the boundary wire (thick black line).
- b) If the suspected boundary wire is long (thick black line) then do as follows: Put AL and G1 back to their original positions. Then disconnect AR. Connect a new loop wire to AR. Connect the other end of this new loop wire at the middle of the suspected wire section.

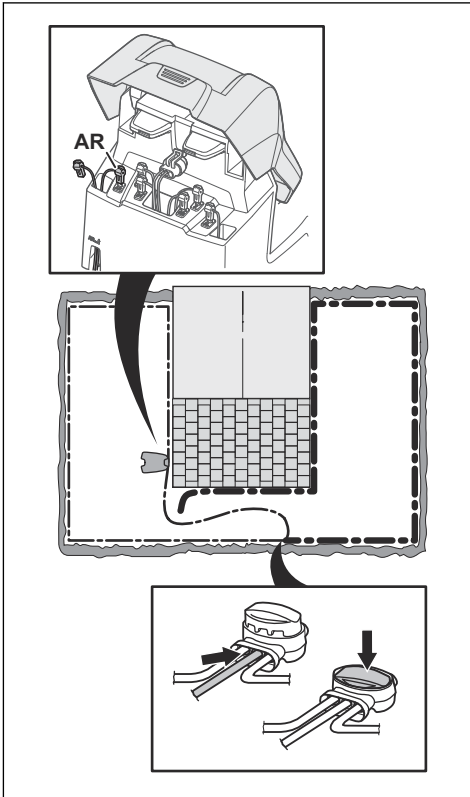

If the indicator lamp now is green, then the break is somewhere in the wire between the disconnected end to the point where the new wire is connected (thick black line below). In that case, move the connection for the new wire closer to the disconnected end (roughly at the middle of the suspected wire section) and check again if the indicator lamp is green.

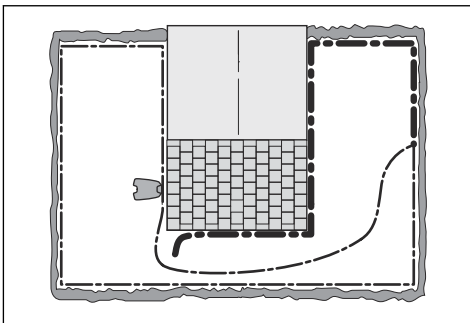

Continue until only a very short section of the wire remains which is the difference between a solid green light and a flashing blue light. Then follow instruction in step 5 below.

4. If indicator lamp still flashes blue in step 3 above: Put AL and G1 back in their original positions. Then switch AR and G1. If indicator lamp now is lit with a solid green light then disconnect AL and connect a new boundary wire to AL. Connect the other end of this new wire at the middle of the suspected wire section. Follow the same approach as in 3a) and 3b) above.
5. When the break is found, the damaged section must be replaced with a new wire. Always use original couplers.

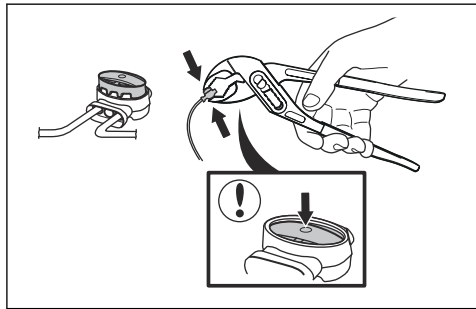

## 7 Transportation, storage and disposal

### 7.1 Transportation

The supplied Li-ion batteries obey the Dangerous Goods Legislation requirements.

- Obey all applicable national regulations.
- Obey the special requirement on package and labels for commercial transportations, including by third parties and forwarding agents.

### 7.2 Storage

- Fully charge the product. Refer to *To charge the battery on page 32*.
- Disconnect the product with the **main switch**. Refer to *To switch off the product on page 31*.
- Clean the product. Refer to *Clean the product on page 33*.
- Keep the product in a dry, frost free space.
- Keep the product with all wheels on level ground during storage, or use a Husqvarna wall hanger.
- If you keep the charging station indoors, disconnect and remove the power supply and all the connectors from the charging station. Put the end of each connector wire in a container with grease.

**Note:** If you keep the charging station outdoors, do not disconnect the power supply and the connectors.

### 7.3 Disposal

- Obey the local recycling requirements and applicable regulations.
- For questions about how to remove the battery, refer to *To remove the battery on page 47*.

#### 7.3.1 To remove the battery



**CAUTION:** Only remove the battery when you dispose the product. When you remove the warranty seal, the Husqvarna warranty is no longer applicable.

1. Disconnect the product with the **Main switch**. Refer to *To switch off the product on page 31*.
2. Pull out the grommet on the charging cable at the very front of the product, and carefully remove the connector.
3. Lift the cover, one corner at a time.
4. Remove the 14 screws with a Torx 20.

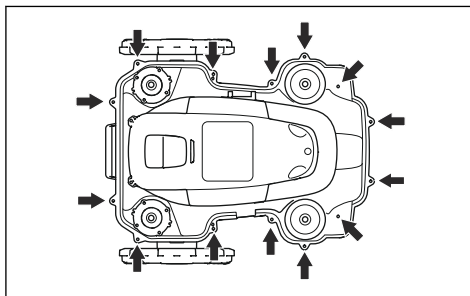

5. Lift the rear edge of the top section of the chassis.
6. Disconnect the cable from the main circuit board.
7. Remove the top section of the chassis.
8. Remove the 3 screws that holds the battery with a Torx 20.

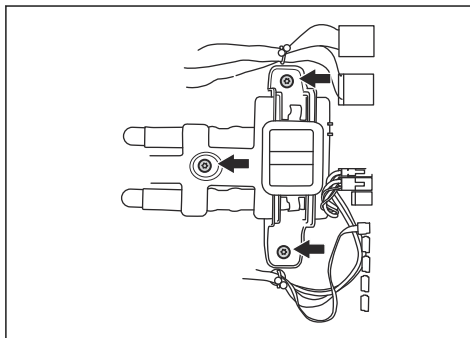

9. Disconnect the battery connection from the main circuit board.
10. Open the battery cover and remove the battery.

## 8 Technical data

### 8.1 Technical data

<b>Dimensions</b>	<b>Automower® 520</b>	<b>Automower® 550</b>
Length, cm / in.	72 / 28.3	72 / 28.3
Width, cm / in.	56 / 22	56 / 22
Height, cm / in.	31 / 12	31 / 12
Weight, kg / lbs	13.3 / 29.3	13.5 / 29.8

<b>Electrical system</b>	<b>Automower® 520</b>	<b>Automower® 550</b>
Battery, Lithium-Ion 18V, 4.0 Ah, Art. No	593 11 41-02, 593 11 42-01, 593 11 41-04, 580 68 33-03	
Battery, Lithium-Ion 18.25V, 4.0 Ah, Art. No	593 11 41-03, 593 11 42-02, 580 68 33-04	
Battery, Lithium-Ion 18V, 5.0 Ah, Art. No		593 11 84-01, 593 11 84-03, 588 14 64-02 (2 pcs.) 5.0 Ah/battery
Battery, Lithium-Ion 18V, 4.9 Ah, Art. No		593 11 84-02, 588 14 64-03 (2 pcs.) 4.9 Ah/battery
Power supply (28V DC), V AC	100-240	100-240
Low voltage cable length, m/ ft	10 / 33	10 / 33
Mean energy consumption at maximum use	17 kWh/month in a 2200 m <sup>2</sup> / 0.55 acre work area	23 kWh/month in a 5000 m <sup>2</sup> / 1.25 acre work area
Charging current, A DC	2.2	7
Type of Power Supply Unit <sup>6</sup>	ADP-60JR XX, FW7438/28/D/XX/Y	ADP-200JR XX, ADP-200MR XX, FW7458/28/D/XX/Y
Average mowing time, min	75	270
Average charging time, min	50	60

<b>Boundary wire antenna</b>	<b>Automower® 520</b>	<b>Automower® 550</b>
Operating Frequency Band, Hz	100-80000	100-80000
Maximum magnetic field <sup>7</sup> , dBuA/m	82	82
Maximum Radio-frequency power <sup>8</sup> , mW @60m	<25	<25

<sup>6</sup> XX, YY can be any alphanumeric characters or blank for marketing purpose only, no technical differences.

<sup>7</sup> Measured according to EN 303 447.

<sup>8</sup> Maximum active output power to antennas in the frequency band in which the radio equipment operates.



Sound data <sup>9</sup>	Automower® 520	Automower® 550
Noise emissions uncertainties $K_{WA}$ , dB (A)	1	1
Measured sound power noise level, dB (A)	58	60
Guaranteed sound power noise level, dB (A)	59	61
Sound pressure noise level at the operator's ear <sup>10</sup> , dB (A)	47	49

Mowing	Automower® 520	Automower® 550
Cutting system	3 pivoted cutting blades	
Maximum cutting motor speed, rpm	2300	2300
Power consumption during cutting, W +/- 20 %	30	35
Cutting height, cm / in.	2-6 / 0.8-2.4	2-6 / 0.8-2.4
Cutting width, cm / in.	24 / 9.4	24 / 9.4
Narrowest possible passage, cm / in.	60 / 24	60 / 24
Maximum slope for cutting area, %	45	45
Maximum slope for boundary wire, %	15	15
Maximum length boundary wire, m / ft	800 / 2600	800 / 2600
Maximum length guide loop <sup>11</sup> , m / ft	400 / 1300	400 / 1300
Maximum distance to boundary wire, m / ft	35 / 115	35 / 115
Working capacity, m <sup>2</sup> / acre(s) +/- 20%	2200 / 0.55	5000 / 1.25

IP-classification	Automower® 520	Automower® 550
Robotic lawn mower	IPX4	IPX4
Charging station	IPX1	IPX1
Power supply	IP44	IP44

Frequency Band Support	
Bluetooth® Frequency range	2400.0-2483.5 MHz
Automower® Connect 2G	GSM 850 MHz, E-GSM 900 MHz, DCS 1800 MHz, PCS 1900 MHz
Automower® Connect 3G	Band 19 (800 MHz), Band 5 (850 MHz), Band 8 (900 MHz), Band 2 (1900 MHz), Band 1 (2100 MHz)
Automower® Connect 4G	Band 12 (700 MHz), Band 17 (700 MHz), Band 28 (700 MHz), Band 13 (700 MHz), Band 20 (800 MHz), Band 26 (850 MHz), Band 5 (850 MHz), Band 19 (850 MHz), Band 8 (900 MHz), Band 4 (1700 MHz), Band 3 (1800 MHz), Band 2 (1900 MHz), Band 25 (1900 MHz), Band 1 (2100 MHz), Band 39 (1900 MHz)

<sup>9</sup> Determined according to Directive 2006/42/EC and standard EN 50636-2-107.

<sup>10</sup> Sound pressure noise uncertainties  $K_{pA}$ , 2-4 dB (A).

<sup>11</sup> The guide loop is the loop that is formed by the guide wire and the part of the boundary wire from the junction with the guide wire to the right connection in the charging station.

<b>Power Class</b>		
Bluetooth® Output power	8 dBm	
Automower® Connect 2G	Power Class 4 (GSM/E-GSM)	33 dBm
	Power Class 1 (DCS/PCS)	30 dBm
	Power Class E2 (GSM/E-GSM)	27 dBm
	Power Class E2 (DCS/PCS)	26 dBm
Automower® Connect 3G	Power Class 3	24 dBm
Automower® Connect 4G	Power Class 3	23 dBm

Full compatibility cannot be guaranteed between the product and other types of wireless systems such as remote controls, radio transmitters, hearing loops, buried electric animal fencing or similar.

The products are made in England or the Czech Republic. See information on the rating plate. Refer to *Product overview on page 4*.

## 8.2 Registered trademarks

The *Bluetooth®* word mark and logos are registered trademarks owned by *Bluetooth SIG, inc.* and any use of such marks by Husqvarna is under license.

---

## 9 Warranty

---

### 9.1 Warranty terms

Husqvarna® warranty covers this product's functionality for a period of 2 years from date of purchase. The warranty covers serious faults relating to materials or manufacturing faults. Within the warranty period, we will replace the product or repair it at no charge if the following terms are met:

- The product and the charging station may only be used in compliance with the instructions in this Operator's Manual. This manufacturer's warranty does not affect warranty entitlements against the dealer/retailer.
- End-users or non-authorized third parties must not attempt to repair the product.

Examples of faults which are not included in the warranty:

- Damage caused by water seepage from using a high-pressure washer, or from being submerged under water, for example when heavy rain forms pools of water.
- Damage caused by lightning.
- Damage caused by improper battery storage or battery handling.
- Damage caused by using a battery that is not a Husqvarna original battery.
- Damage caused by not using Husqvarna original spare parts and accessories, such as blades and installation material.
- Damage to the loop wire.
- Damage caused by non-authorized changing or tampering with the product or its power supply.

The blades and wheels are seen as disposable and are not covered by the warranty.

If an error occurs with your Husqvarna product, please contact Husqvarna customer service for further instructions. Please have the receipt and the product's serial number at hand when contacting Husqvarna customer service.

---

# 10 EC Declaration of Conformity

---

## 10.1 EC Declaration of Conformity

**Husqvarna AB**, SE-561 82 Huskvarna, Sweden, tel: +46-36-146500, declares that the robotic lawn mowers **HUSQVARNA AUTOMOWER® 520, 550** with serial numbers dating 2020 week 45 and onwards (the year and week is clearly stated on the rating plate, followed by the serial number), comply with the requirements of the COUNCIL'S DIRECTIVE as listed below including applied standards.

- Directive "relating to machinery" **2006/42/EC**.
  - **EN 60335-1:2012**
  - **EN 50636-2-107:2015**
  - **EN 62233:2008**.
- Directive on "restriction of use of certain hazardous substances" **2011/65/EU**:
  - **EN IEC 63000:2018**
- Directive "relating to radio equipment" **2014/53/EU**.  
**Safety**
  - See directive **2006/42/EC** above.

### Electromagnetic compatibility

- **EN 55032:2015**
- **ETSI EN 301 489-1** V2.2.3
- **ETSI EN 301 489-17** V3.1.1
- **ETSI EN 301 489-19** V2.1.1
- **ETSI EN 301 489-52** V1.1.1

### Efficient use of the spectrum

- **Draft ETSI EN 303 447** V1.2.1\_0.1.14
- **ETSI EN 300 328** V2.2.2

For HUSQVARNA AUTOMOWER equipped with Automower Connect 3G/2G:

- **ETSI EN 301 511** V12.5.1
- **ETSI EN 301 908-1** V13.1.1
- **ETSI EN 301 908-2** V11.1.2
- **ETSI EN 303 413** V1.1.1

For HUSQVARNA AUTOMOWER equipped with Automower Connect 4G/2G:

- **ETSI EN 301 511** V12.5.1
- **ETSI EN 301 908-1** V13.1.1
- **ETSI EN 301 908-13** V11.1.2
- **ETSI EN 303 413** V1.1.1











**Husqvarna**<sup>®</sup>

AUTOMOWER<sup>®</sup> is a trademark owned by Husqvarna AB.  
Copyright<sup>®</sup> 2021 HUSQVARNA. All rights reserved.

[www.husqvarna.com](http://www.husqvarna.com)

---

Original instructions

1142659-26



2021-01-19