

SPROLINK[®]

www.sprolink.com

SEAMLESS PROFESSIONAL SCALER AND SWITCHER



VC1

USER MANUAL

Content

1. Product Features	2
2. Product Introduction	3
3. Hardware Overview	4
3.1 Front Panel.....	4
3.2 Back Panel.....	6
4. Operations	7
4.1 Menu Structure.....	7
4.2 Output Format.....	8
4.3 Screen Parameters Setting.....	10
4.4 PIP Setting.....	10
4.5 Cascading Split Setting.....	12
4.6 EDID Management.....	15
4.7 Advanced Settings.....	16
4.7.1 Input.....	16
4.7.2 Output.....	17
4.7.3 Special-effect transitions (double-click MENU).....	17

1. Product Features



- Supports Seamless Switching Between All the Signals
- Supports Customized Resolution Within 2.5 Million Pixels
- PIP Combination of Any Two Signals
- Supports EDID Management, to Realize Pixel to Pixel
- Multiple Units Could Be Cascaded
- With Built-in Slot for 2 Sending Cards
- Support Thirty Party Control System with Open Protocol

2. Product Introduction

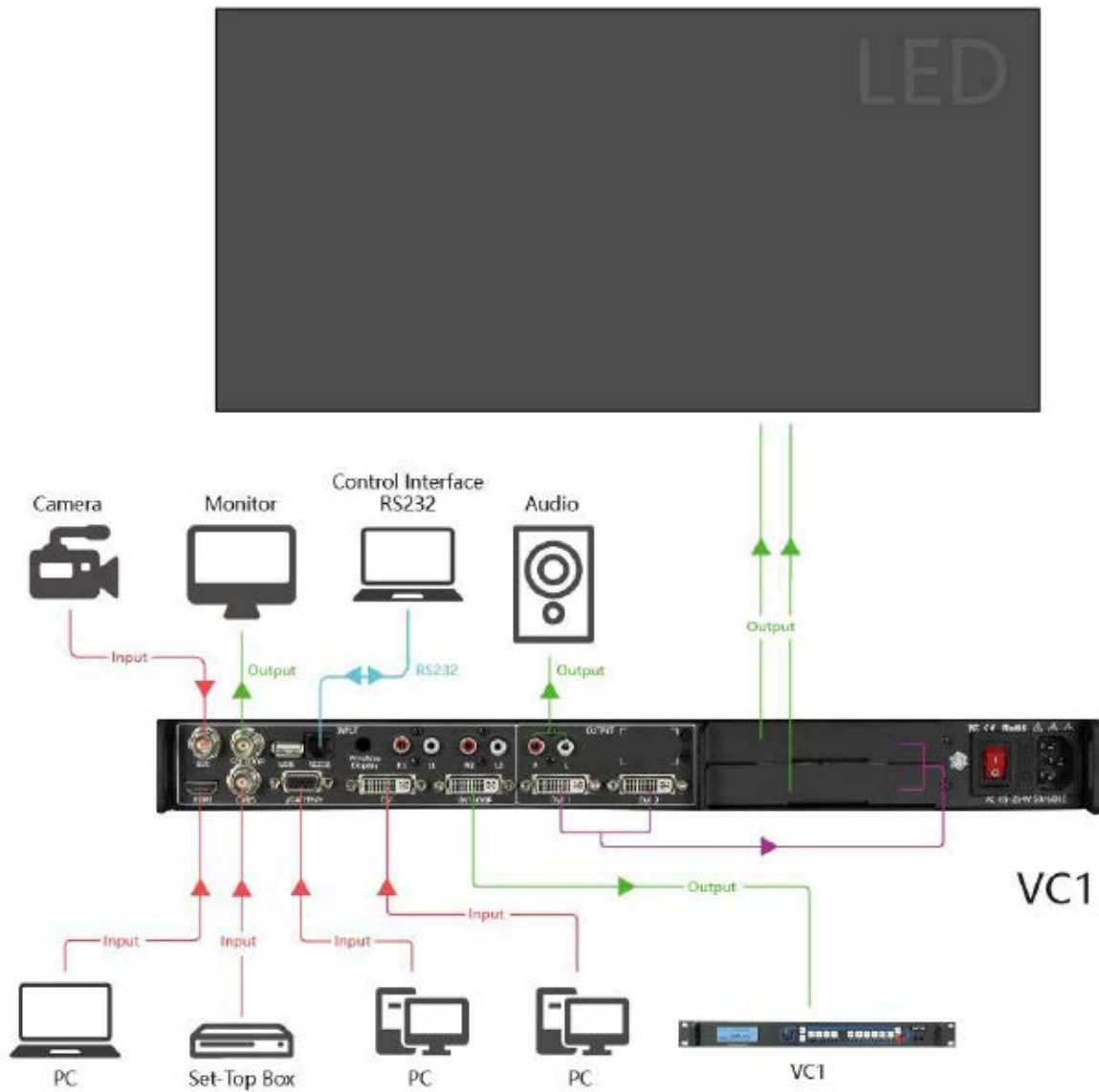

3. Hardware Overview

3.1 Front Panel

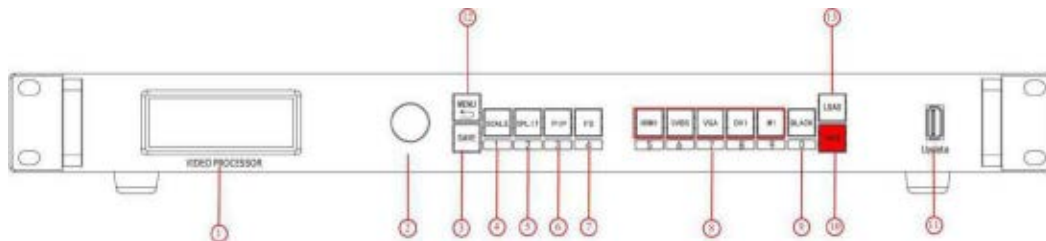

OLED display panel

1	Display the current working status and menu for buttons control.
---	--

Knob

2	Use for menu selection: rotating knob to find the option, and press the knob to confirm.
---	--

Buttons

3	SAVE button: To save the parameters after setting, by using "LOAD" to load the saved data. Press SAVE, the buttons "SCALE.....BLACK" are representing saving modes of 1\2\3\4\5\6\7\8\9\0 separately, press any button to save the current parameters to the specified saving mode.
4	SCALE Button: To adjust the size and position of the picture, input numbers by the " 1-0" buttons under M1-DVI 4, or using the knob to adjust the number.
5	SPLIT Button: To make multiple units cascaded, and setting split parameters.
6	PIP Button: Turn on two signals displaying and adjust pictures layout between

	layer A and layer B.
7	<p>FS Button: Press FS button to show in the full-screen display mode</p>
8	<p>INPUT Button: To select source signal, the button lights up while used as input. When there are more than 2 buttons lighting up, the one flashing is the one just be chosen, and the steady lighting one is the source signal displayed, M1 represents SDI input.</p>
9	<p>Black Button: Press to show black screen.</p>
10	<p>TAKE Button: In the working mode of TAKE, choose the preset picture, and press TAKE to switch into the main output. Press TAKE for 5 seconds to enter into TAKE working mode, press 5 seconds to turn it off.</p>
11	<p>USB: To program or upgrade.</p>
12	<p>MENU Button: Press to enter into the menu, by using knob to find the specified menu, press MENU again to return to the previous menu.</p>
13	<p>LOAD Button: To load the preset saving modes. Press LOAD, buttons of "SCALE---BLACK" are representing saving modes of 1\2\3\4\5\6\7\8\9\0, press any of the key to load the corresponding saving modes.</p>

3.2 Back Panel

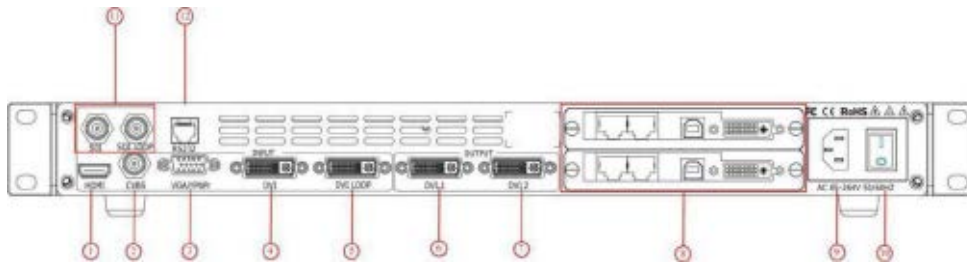

Input connectors

1	HDMI 1.3: Supports 2560*816@60 and 2k input
2	CVBS: Supports input of 576i and 480i
3	VGA\Ypbpr: Supports 2k input, this could be set as VGA or Ypbpr input in the advanced menu.
4	DVI: Supports 2k input and user defined EDID
5	SDI + SDI Loop: Optional module, support 3G SDI\HD SDI\SD SDI

Output connectors

6	DVI LOOP: Output the original DVI signal to another device, usually used in cascading to another device
7	DVI 1 output: Output to the monitor or sending card display screen.
8	DVI 2 output: Output to the monitor or sending card display screen, the same picture as DVI 1
9	Card slot: Built-in card slot for 2 sending cards(small)

Switching and power supply

10	IEC-Power connector: AC 85-264V, 50/60HZ, maximum power 45W
11	Power switch

4. Operations

- Menu Structure
- Output Format
- Screen Parameters Setting
- PIP Setting
- Cascading Split Setting
- EDID management
- Advanced Settings

4.1 Menu Structure

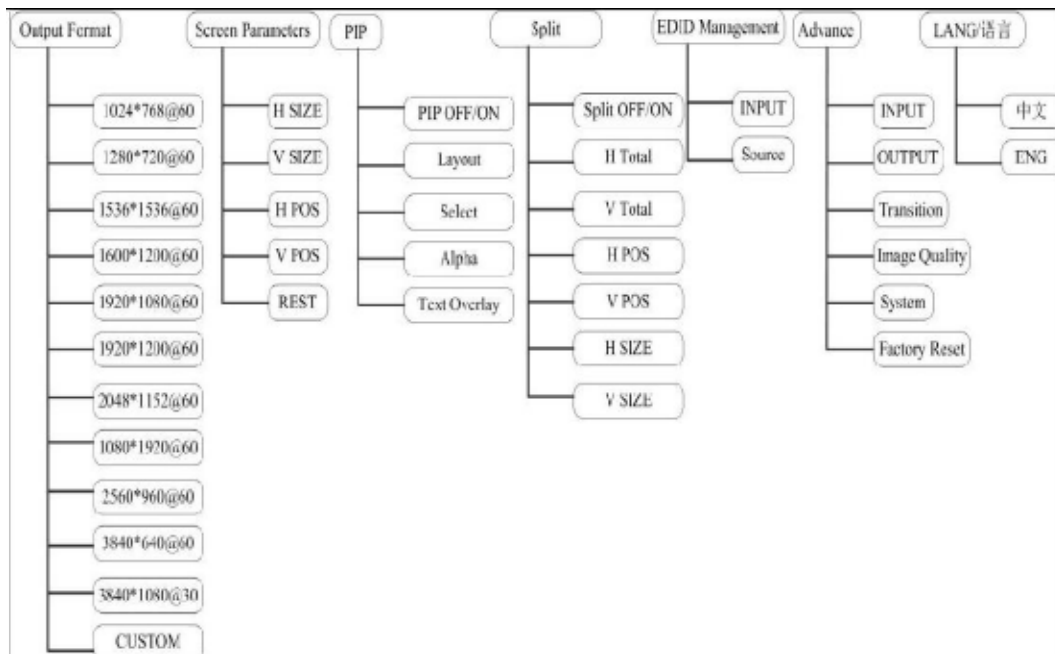

4.2 Output Format

VC1 default output resolution is 1920*1080@60, push SCALE button to resize display when the screen is smaller than 1920*1080, set the output resolution as below:

1. Press MENU button to find the resolution and press knob to confirm.



2. Turning the knob to find the correct resolution, or choose "Customized Resolution", press knob to Confirm.

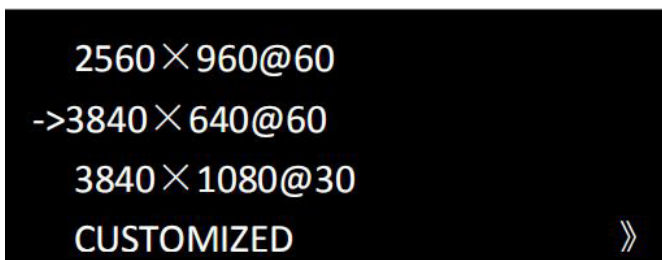
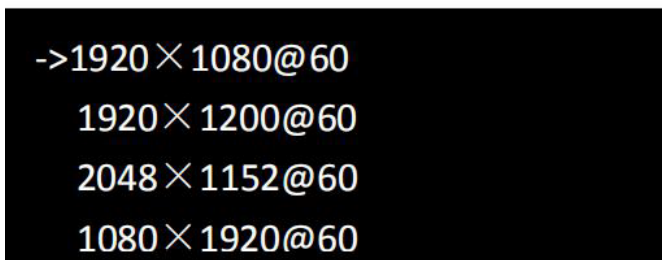
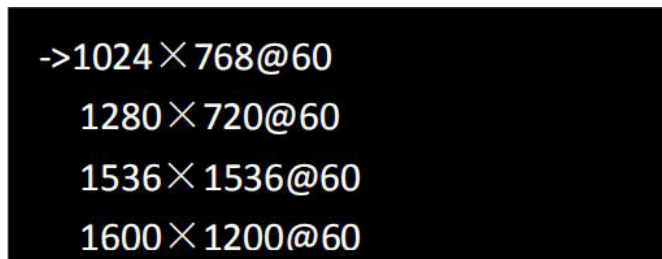

3. Enter into "Customized Resolution" , press knob to confirm.

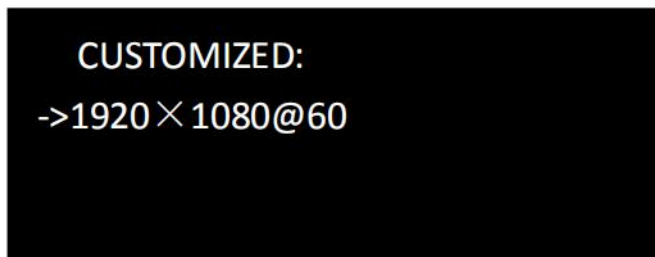

4. Set Input resolution as: 2880x768@60HZ.

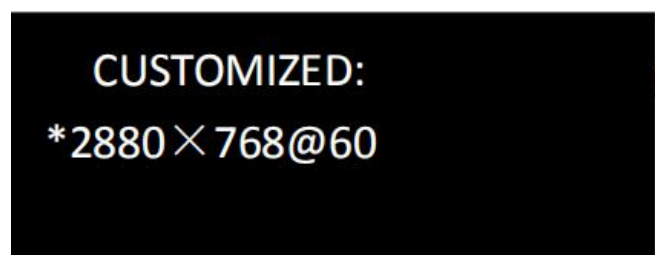

5. Set 2880 by the numeric buttons, press knob and then set 768 and 60fps. Push knob to confirm settings.

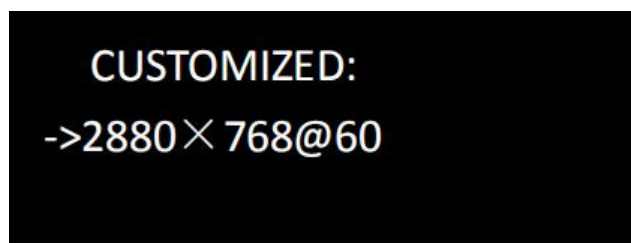

6. Press MENU, return to the previous menu to check if it was changed successfully.

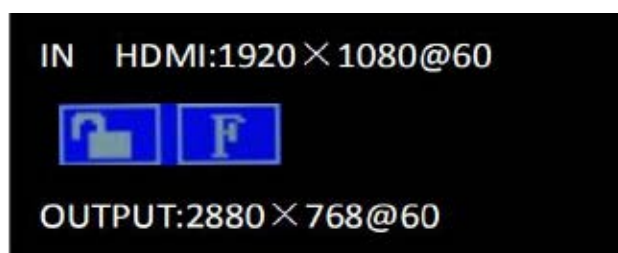

4.3 Screen Parameters Setting

After set the output resolution, scale the full image on screen. Here we make picture full-fill the screen size in 1536*1080.

Press SCALE button, turning the knob to find the width, press knob to revise it, when the icon changed into “->” , “1/2/3/...0” Screen-silk buttons light up, these are the numeric button to set parameters.

Width 1536 resolution, press knob to confirm.

Set the height in the same way, resize it into 1080.

-> H	SIZE	1536
V	SIZE	1080
H/V	SIZE	1536
H	POS	0

4.4 PIP Setting

Dual pictures display: how to make PIP function, and one layer in the center of screen of 1920*736.

1. Turn on PIP: PIP could be active by PIP button or PIP in MENU.

OUTPUT FORMAT	»
SCREEN PARAMETERS	»
-> PIP	»
SPLIT	»

2. Choose the layout- "centered" .

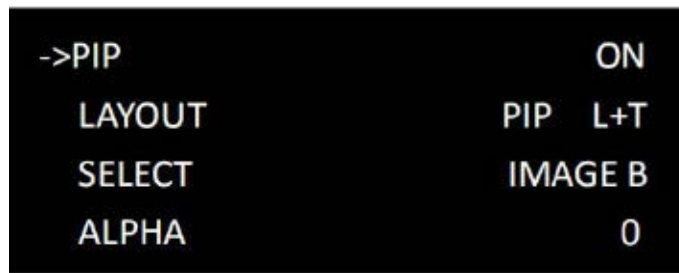

3. Select AB layers to adjust, A represents the bigger picture in background, and B represents the smaller one in foreground.

(As long as PIP is available, SPLIT button could also be used to select layer A or layer B) .



4. Start with layer A, firstly press DVI button to switch source signal into DVI button.



5. Set picture size of layer A: press Scale button to set the layer A size into 1920*736, layer A size was setting successfully.

H	SIZE	1920
->V	SIZE	736
H/V	SIZE	1920
H	POS	0

6. Press SPILT button to choose layer B, use HDMI signal as the source for the smaller picture.

7. Resize layer B: press Scale button to set size and position of layer B.



8. Press SAVE button to save all above parameters into the saving mode, it could be easily used by press "LOAD button" in the future applications.

4.5 Cascading Split Setting

There is a screen 3328*960, the 1792*960 resolution on the left, the 1536*960 resolution on the right. Adjust the picture to full fill the screen,

2 sending cards and two units of VC1 use here.

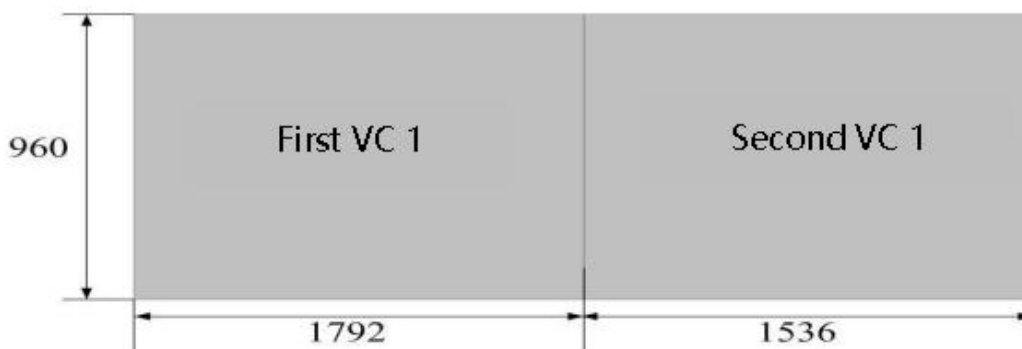

Setting as below

Apply DVI signal input for the first unit of VC1, the same signal was given to the second processor by DVI LOOP out. For the first VC1 with DVI 1 output to the sending card 1 for the left screen, the second VC1 with DVI 1 output to the sending card for the right screen.

Parameters setting of the first VC1

1. Press SPILT button to enable control.

SPLIT	ON
-> H TOTAL	3328
V TOTAL	960
H POS	0

2. Set height and width of the whole screen 3328*960.

SPLIT	ON
H TOTAL	3328
-> V TOTAL	960
H POS	0

3. Set the position of the current device parameter, the default position is 0,0 (0 in horizontal and 0 vertical)

SPLIT	ON
H TOTAL	3328
-> V TOTAL	960
H POS	0

4. Set the width and height parameter in the first device to 1792*960.

SPLIT	ON
H TOTAL	3328
-> V TOTAL	960
H POS	0

V POS	0
-> H SIZE	1792
V SIZE	960
SAVE TO	>>

Save all settings into saving mode 1.

Parameters setting of the second VC1

1. The second VC1 is for the right screen, so the position is behind the first screen, the total width and height is the same as the first VC1.

SPLIT	ON
H TOTAL	3328
V TOTAL	960
->H POS	1792

2. Set the current screen width and height 1536*960.

-> V POS	0
H SIZE	1536
V SIZE	960
SAVE TO	>>

3. Save all above settings into saving mode 1 as well.

All the settings were finished, tiny adjustments could be done if there is any problem.

4.6 EDID Management

PC output resolution is 1920*1080, EDID Management can custom the input resolution to make pixel by pixel display in screen. Here we apply EDID on 1536x1536 screen.

1. Press MENU button enter into EDID Management.

->EDID MANAGEMENT	>>
ADVANCE	>>
LANG/语言	ENG

2. Press knob to enter EDID editing, choose DVI.

```
INPUT          DVI
*SOURCE       YSDVI
```

3. Find EDID source, choose user-defined

```
INPUT          DVI
->SOURCE      CUSTOM
```

4. Press the knob to confirm, setting the resolution as 1536x1536.

```
CUSTOMIZED:
->1536×1536@60
```

5. EDID modification finished, some PC need to be plugged in and out to enable it.

4.7 Advanced Settings

4.7.1 Input

Enlarge: crop the picture, cut off unnecessary part of the picture, enlarge picture in the following methods.

```
H  LEFT      0
H  RIGHT     0
H  LEFT/RIGHT 0
-> CENTER    0
```

VGA adjustment: adjust VGA input offset.

```
->AUTO ADJUST
H POS 1792
V POS 1792
CLOCK 1792
```

ADC adjustment: adjust offset of signals like CVBS etc.

```
->ADC AUTO ADJUST >>
ADC RESET ALL >>
```

4.7.2 Output

Output signal selection: change output signal in DVI or HDMI format Bit

depth: adjust output bit depth.

Color range: adjust into image or video, when "black screen function

"is not working, you should firstly check the color rang here.

DE adjustment: Used to adjust the output offset.

```
->DVI MODE DVI
BIT DEPTH 8 BIT
DATA RANGE IMAGE
DE ADJUST >>
```

4.7.3 Special-effect transitions (double-click MENU)

Deinterlacing: all interlace lines would be removed after deinterlacing

enabled Image. Enhancement: this function is valid for main source

signal by default, screen would be black for a few seconds when switching into the other signal.

Switching mode: Multiple switching modes like pull - curtain switching and fade in fade out, straight cut, etc.: Multiple curtain switch and fade in and fade out, straight cut and so on.

Switching Time: switching time could be set between 0~3 seconds.

->DEINTERLACE	ON
IMAGE ENHANCE	OFF
MODE	DISSOLVE
FADE TIME	0.5S

Image quality adjustment: Brightness, contrast, saturation, sharpness etc., all could be adjusted according to your request.

-> BRIGHTNESS	51
CONTRAST	55
SATURATION	50
SHARPNESS	50

Hot backup: hot backup for input.

After enable hot backup, set the first group as backup signal.

Input would be automatically switch to the second group when first signals disappeared. Input would be automatically switch to the third group when losing the second signals.

HOT BACKUP	ON
BACKUP_1	DVI
BACKUP_2	HDMI
-> BACKUP_3	VGA

Customized buttons: Black button could be customized.

Factory reset: Settings and options will be restored to factory state.



Language: This device supports Chinese and English.

SPROLINK[®]

CREATIVE VIDEO REVOLUTION

XIAMEN SPROLINK SCIENCE & TECHNOLOGY CO., LTD

 Unit 301, No.1734, Gangzhong Road, Xiamen Free Trade Zone, China.

 sales@sprolink.com  +86 592 556 5698  www.sprolink.com