

**SPECIAL
LITE** PRODUCTS COMPANY, INC.

Site Amenities

**Traffic Regulatory Signage,
Poles, Hardware & Accessories
and Commercial Lighting**

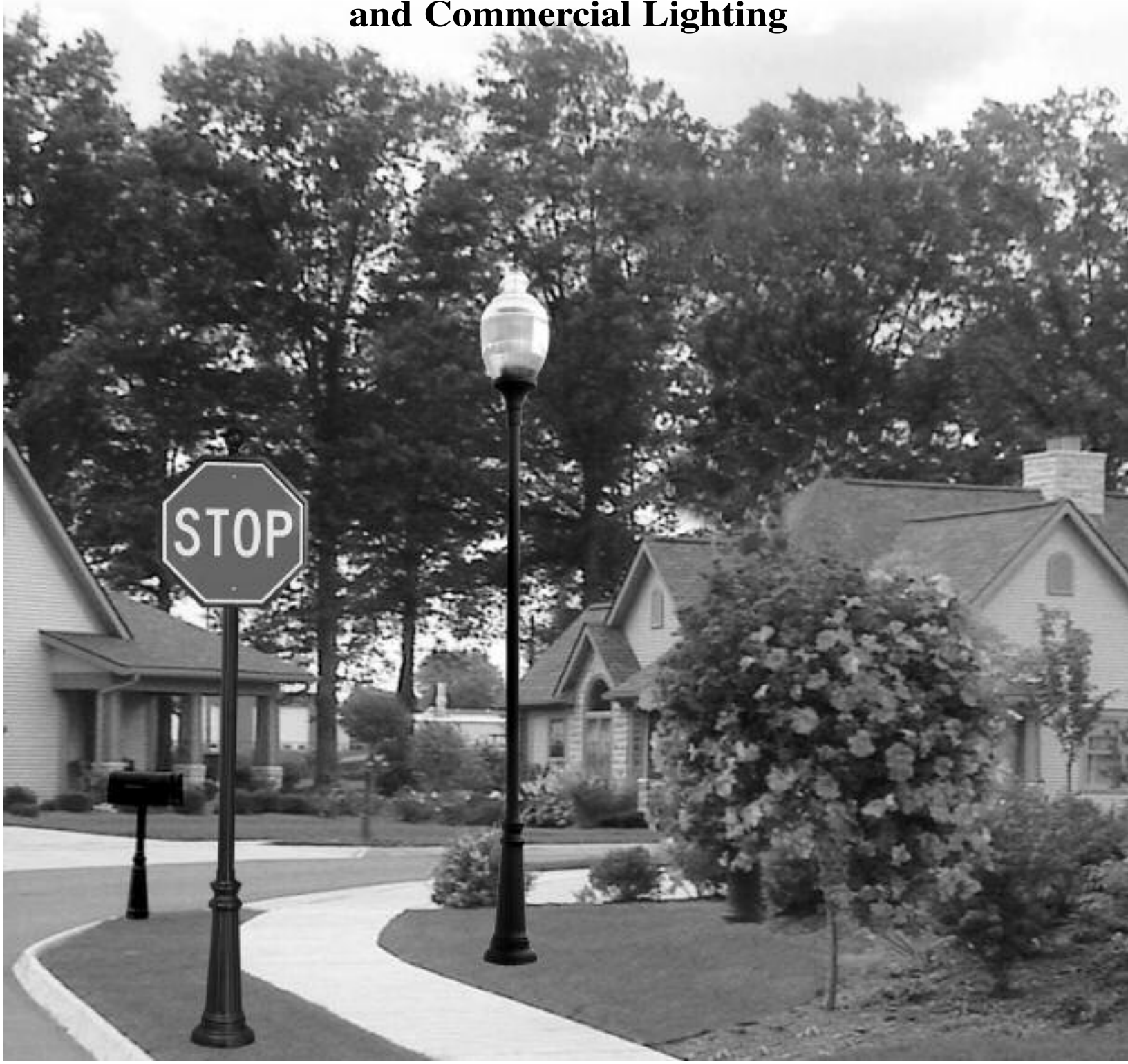



1634 Latrobe-Derry Road Loyallhanna, PA 15661
Phone 724-537-4711 Fax 724-537-9313
www.specialliteproducts.com
customer_service@specialliteproducts.com

For over forty years Special Lite Products Company, Inc. has been designing and manufacturing the finest quality commercial and residential lighting, mailboxes and signage products.

This new Site Amenities catalog is focused for the commercial and residential developer, home builders associations and home owners associations.

Whether you have been purchasing from us since the sixties or are contemplating ordering for the first time, our commitment to you will always remain the same: a quality product, an excellent value, and outstanding customer service. Your complete satisfaction is our only goal.



Turn your project
from *ordinary* to
EXTRAORDINARY!

Special Lite Products has a large selection of Lighting Fixtures, Traffic Signage and Mailboxes. We can also custom design products to meet your needs!

Call us today...





Vista Series

3" & 4" O/D Round Fluted Pole •A low cost method to inspire sales by adding street appeal
 •Maintenance Free •Also Available in a U.S. Department of Transportation approved Break Away Pole

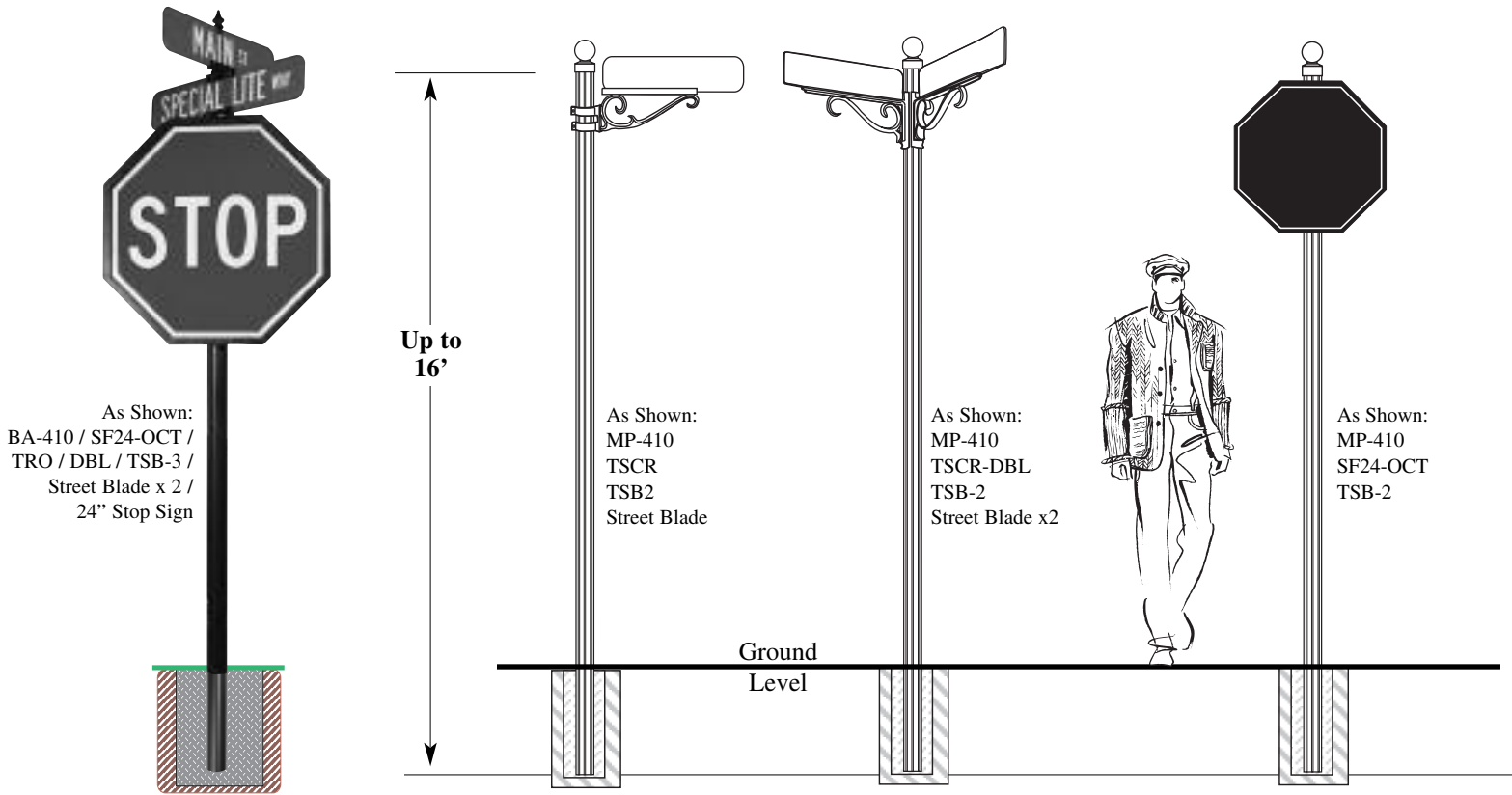

Classic Series

3" & 4" O/D Round Fluted Pole •Help build the sales of your Community by adding continuity to appearance and theme. •Compliments traditional and contemporary architecture
 •Also Available in a U.S. Department of Transportation approved Break Away Pole

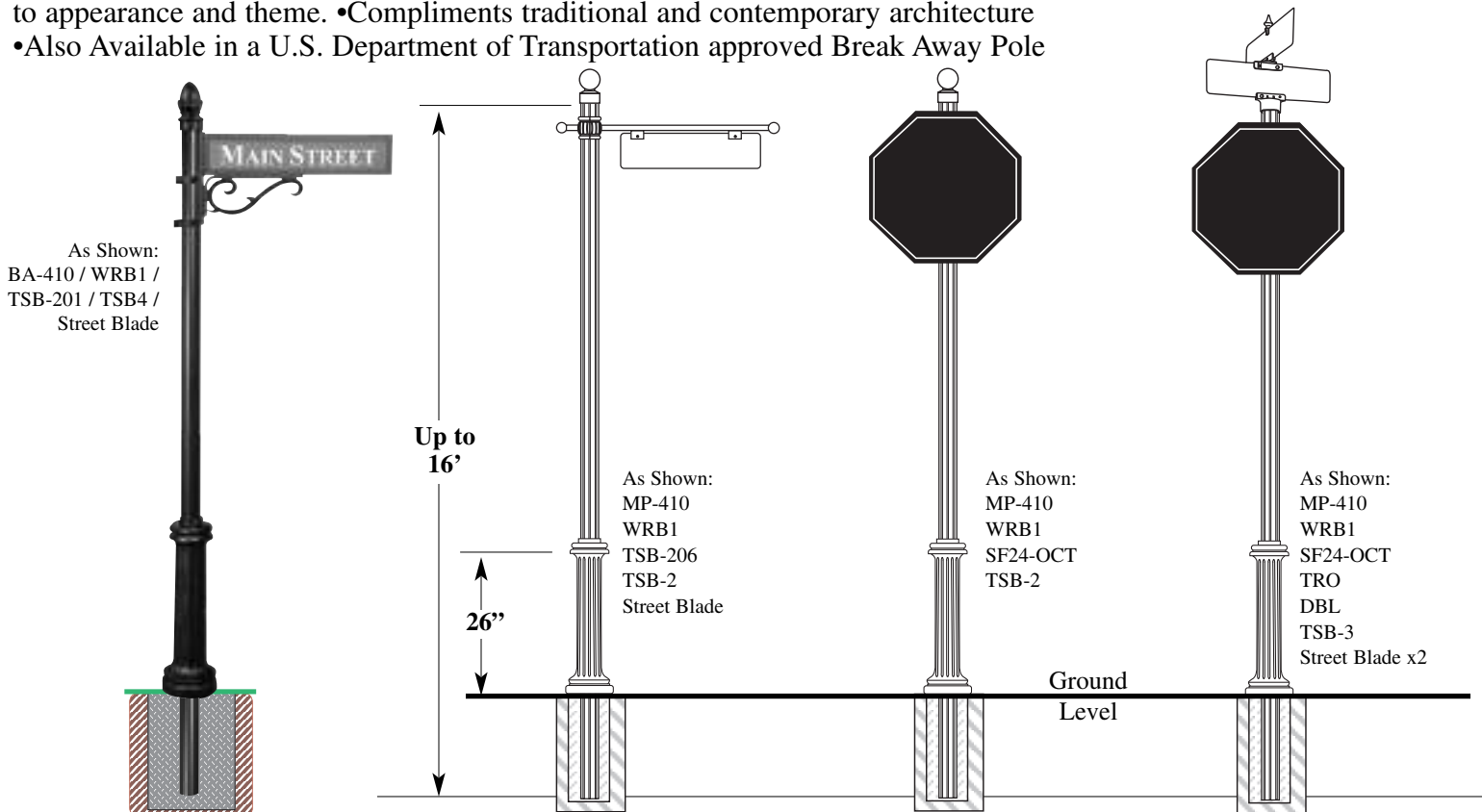

Vista Series poles available in:



3" Smooth Breakaway



3" Fluted



3" Fluted Breakaway

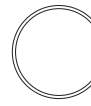

4" Smooth



4" Fluted

Approved By:



Approved By:

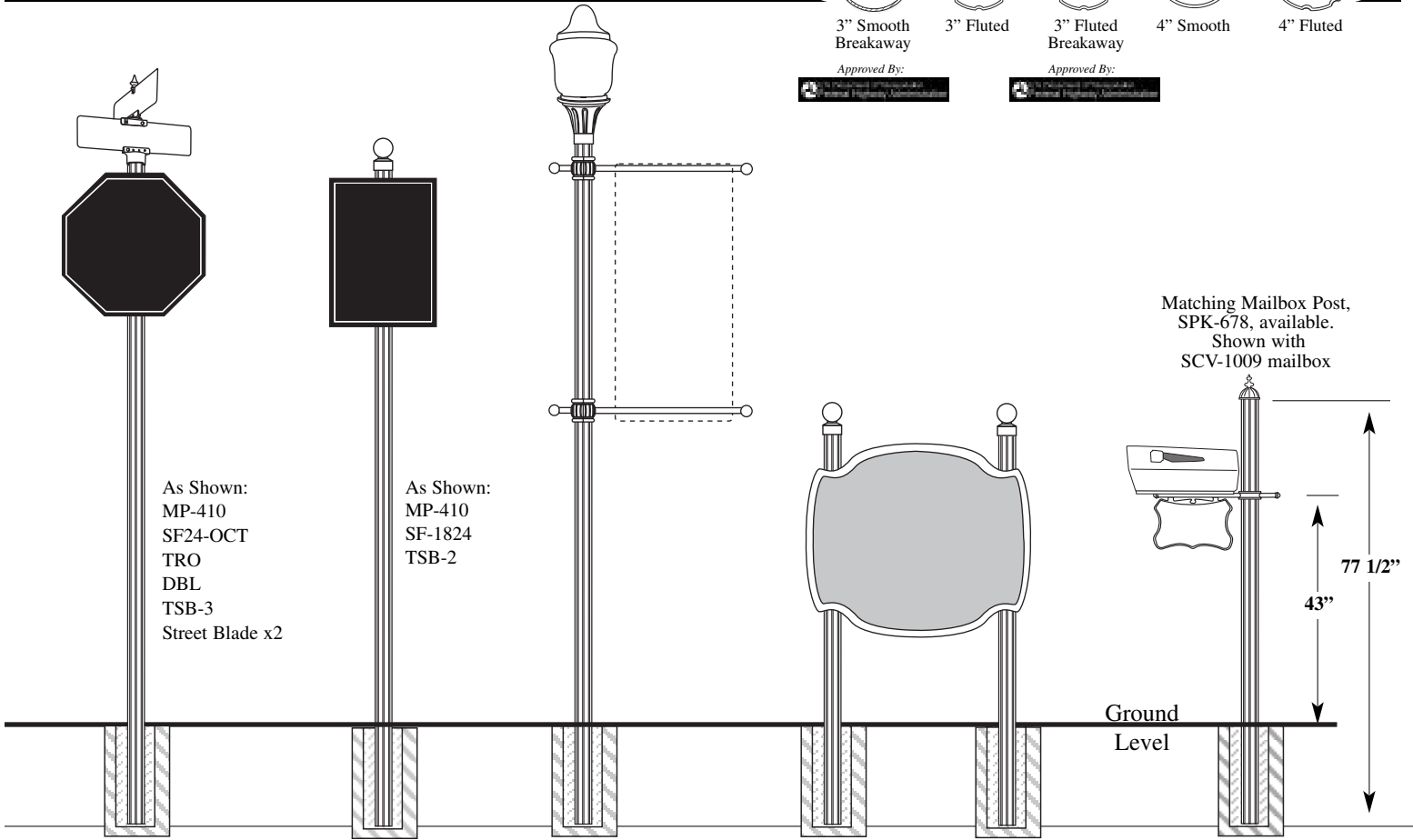

As Shown:
MP-410
SF24-OCT
TRO
DBL
TSB-3
Street Blade x2

As Shown:
MP-410
SF-1824
TSB-2

Matching Mailbox Post,
SPK-678, available.
Shown with
SCV-1009 mailbox

Ground
Level

Classic Series poles available in:



3" Smooth Breakaway



3" Fluted



3" Fluted Breakaway

Approved By:



Approved By:

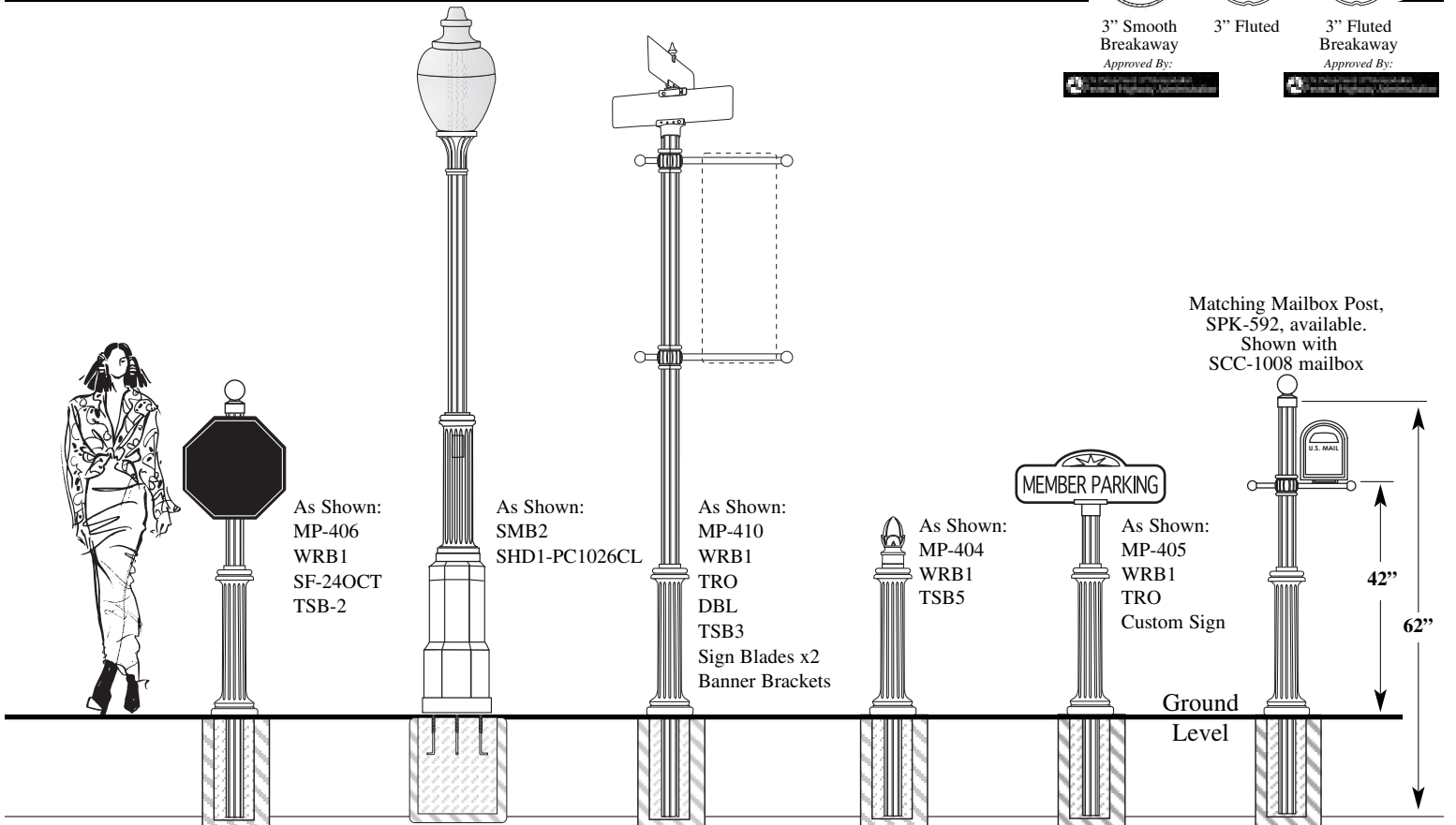

As Shown:
MP-406
WRB1
SF-24OCT
TSB-2

As Shown:
SMB2
SHD1-PC1026CL

As Shown:
MP-410
WRB1
TRO
DBL
TSB3
Sign Blades x2
Banner Brackets

As Shown:
MP-404
WRB1
TSB5

As Shown:
MP-405
WRB1
TRO
Custom Sign

Matching Mailbox Post,
SPK-592, available.
Shown with
SCC-1008 mailbox

Ground
Level



Main Street Series

4"x4" Square Pole with sculpted corners •Rust Free Extruded Aluminum •Maintenance free Powder Coated base finishes •Coordinating mailboxes, mailbox posts, address plaques and outdoor lighting

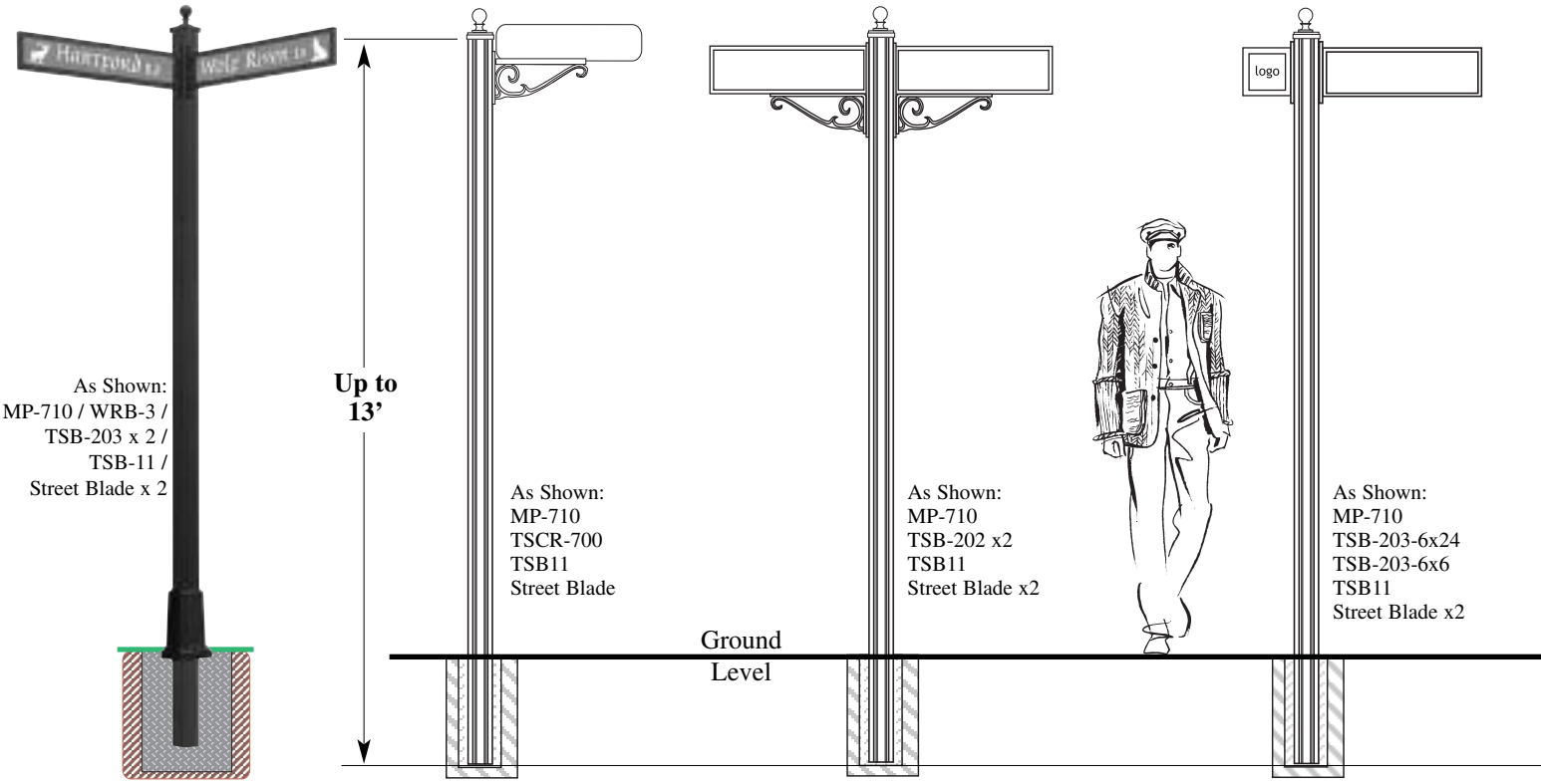

Town Square Series

3" & 4" O/D Round Fluted Pole •High Grade Aluminum with Brass and Stainless Steel Hardware increases Property Values •Also Available in a U.S. Department of Transportation approved Break Away Pole

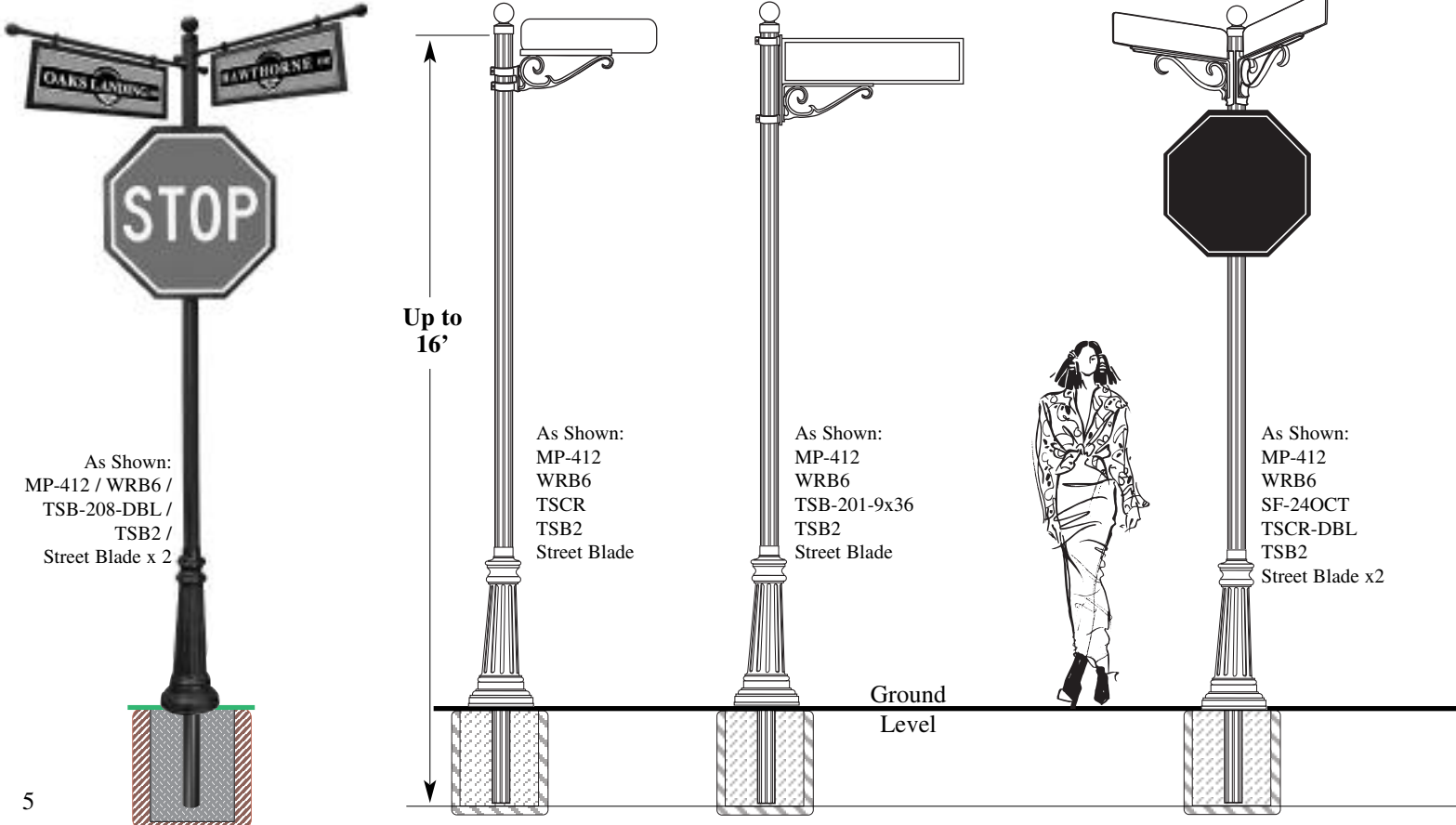

Main Street Series poles available in:

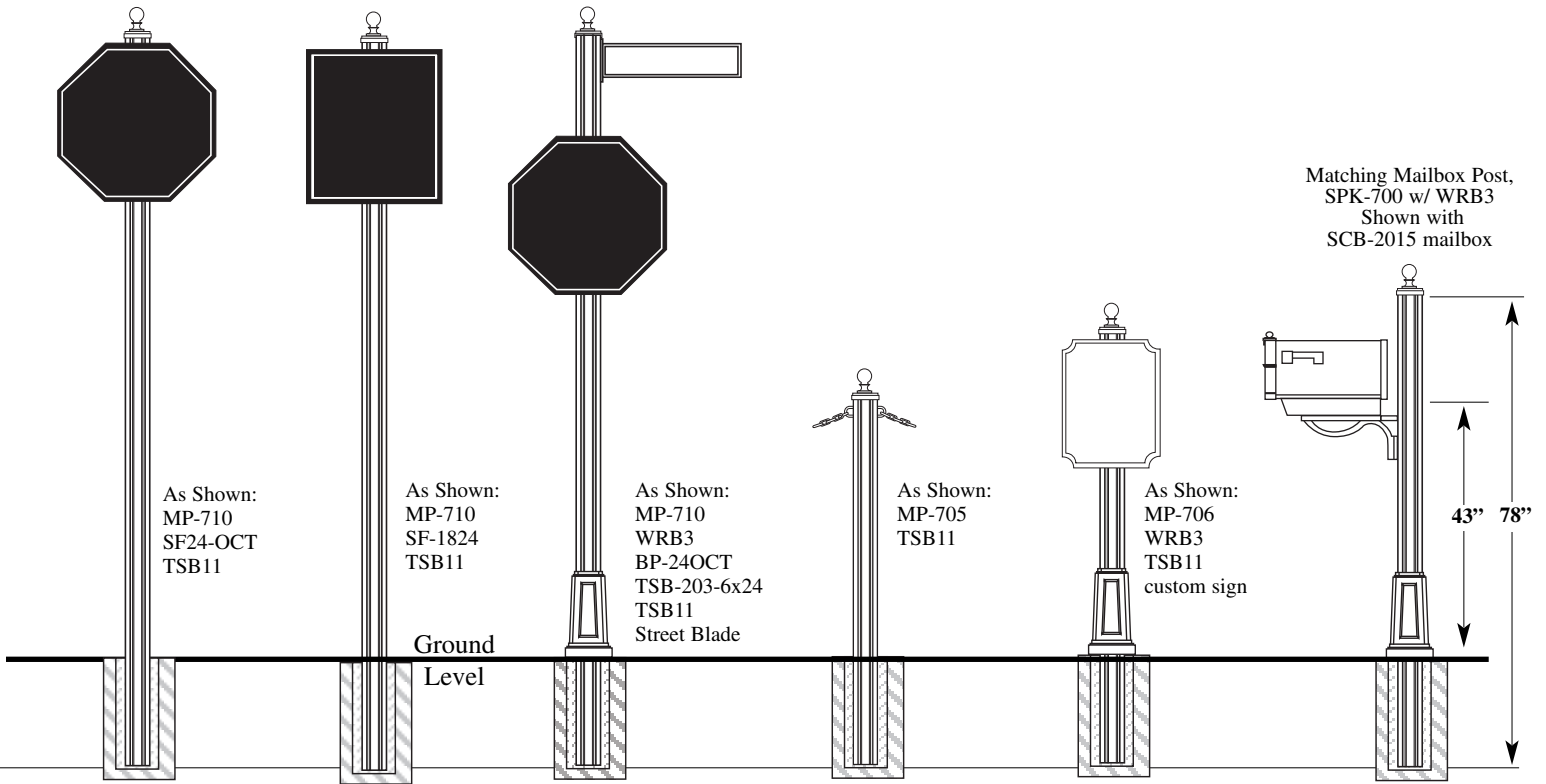
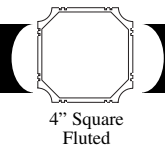

Town Square Series poles available in:

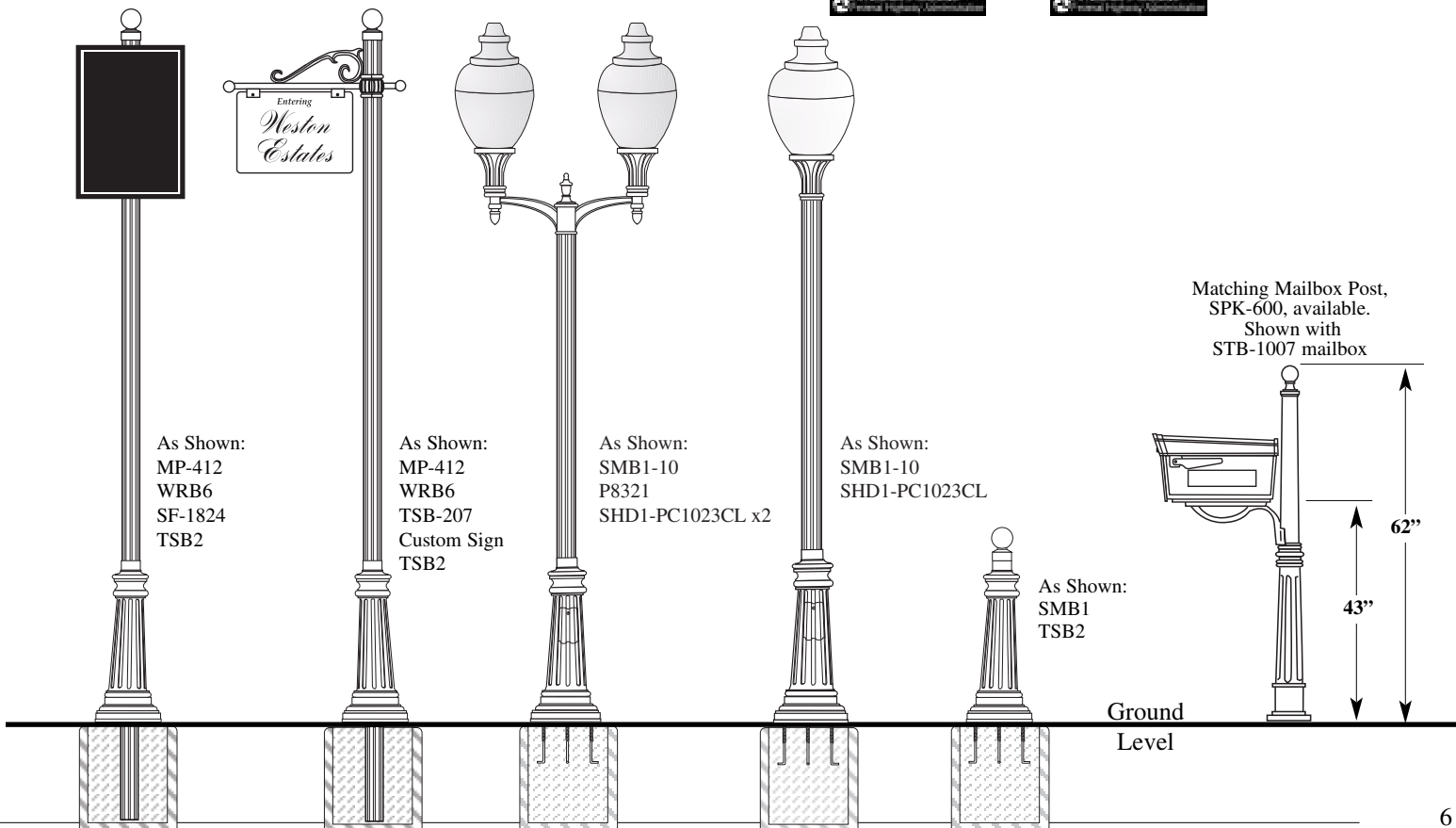
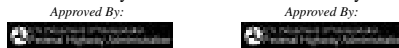

3" Poles and Accessories

Our Direct Burial Poles and accessories are made of Extruded Aluminum and Cast Aluminum and are available in your choice of 14 durable powder coated base finishes. Poles require a minimum of 18" of the pole be submerged into the concrete pad for proper installation. The end user must check the local codes and ordinances for minimum depth required for safe installation.

Ordering Example: BA-410 / WRB6 / TSB-201 / TSB2. (3" x 10' Smooth Pole / Town Square Base / Single Sign Mount / Pole Topper)

Pole Toppers: All Toppers completely cover the top of the post to keep out the elements.



TSB2



TSB4



TSB5



TSB7



TSB10

Poles: 3" O/D Extruded Aluminum Poles.

(Break Away Poles are Federal Highway Administration Approved).

As Shown:
BA-410 / WRB6 / TSCR-DBL / TSB2 / SF-24OCT

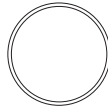

Smooth Break Away
FHWA Approved Breakaway Smooth Wall Pole

Over All Pole Length	8' Length	10' Length	12' Length	14' Length	16' Length
	Model #	Model #	Model #	Model #	Model #
	BA-408	BA-410	BA-412	BA-414	BA-416

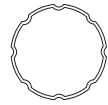

Fluted
Fluted channels adds to the strength of the pole and presents a more upscale appearance

MP-408	MP-410	MP-412	MP-414	MP-416
--------	--------	--------	--------	--------



Fluted Break Away
FHWA Approved Breakaway Fluted Wall Pole

BC-408	BC-410	BC-412	Not available at this time	Not available at this time
--------	--------	--------	----------------------------	----------------------------

Bases: Bases fit over a 3" O/D round pole to add a decorative touch to the pole. Made of cast aluminum with a powder coated finish.



WRB1
Vista Series
Two Piece Design
26" Height
7 1/2" Dia.



WRB2
Del Flora Series
26" Height
6 3/4" Dia.



WRB6
Town Square Series
32" Height
11 3/4" Dia.



WRB7
4 3/16" Height
7" Dia.



WRB8
10 1/4" Height
9 1/4" Dia.

3" Pole - Street Sign Mounting

The TSB series of Street Sign Holders can be ordered to hold any size Sign Blade. Add the height and length of the Sign Blade in inches to the end of the item number of the desired sign. For example: for a 6" x 24" Sign Blade in a TSB201 bracket the item number would be TSB201-624. Length of the arm's bar will vary with the length of the Sign Blade. Sign Blades sold separately.

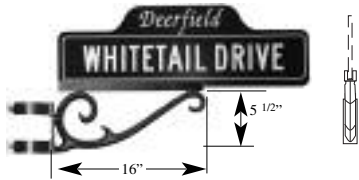

item# **TSCR**
for use with 3" O/D round poles
Scroll: 16" long, 5 1/2" high



item# **TSCR-700**
for use with any Special Lite pole
Scroll: 16" long, 5 1/2" high



item# **TSCR-DBL**
Two TSCR brackets welded together at a 90° angle. For use with 3" O/D round poles
Scroll: 16" long, 5 1/2" high



item# **TSB-201**
for use with 3" O/D round poles
TSB201-624: holds 6" x 24" Street Blade
Scroll: 16" long, 5 1/2" high



item# **TSB-201-DBL**
Two TSB-201 brackets welded together at a 90° angle. For use with 3" O/D round poles
Scroll: 16" long, 5 1/2" high



item# **TSB-202**
for use with any Special Lite pole
TSB202-624: holds 6" x 24" Street Blade
Scroll: 16" long, 5 1/2" high



item# **TSB-203**
for use with any Special Lite pole
TSB-203-624: holds 6" x 24" Street Blade
Shown with a **TSB-203-66** Custom Frame
Custom Frames can be used to display logos and other images opposite street signs.



item# **TSB-205**
for use with 3" O/D round poles
TSB205-624: holds 6" x 24" Street Blade



item# **TSB-205-DBL**
Two TSB-205 brackets welded together at a 90° angle. For use with 3" O/D round poles



item# **TSB-206**
for use with 3" O/D round poles



item# **TSB-207**
for use with 3" O/D round poles
Scroll: 16" long, 5 1/2" high



item# **TSB-208**
for use with 3" O/D round poles
(shown mounted to smooth pole - sold separately.)



item# **TSB-208-DBL**
for use with 3" O/D round poles
(shown mounted to smooth pole with TSB2 pole topper - both sold separately.)



item# **TSB-209**
for use with 3" O/D round poles
(shown mounted to smooth pole with TSB2 pole topper - both sold separately.)



item# **TSB-210**
for use with 3" O/D round poles
(shown mounted to smooth pole - sold separately.)

4" Poles and Accessories







Our Direct Burial Poles and accessories are made of Extruded Aluminum and Cast Aluminum and are available in your choice of 14 durable powder coated base finishes. Poles require a minimum of 18" of the pole be submerged into the concrete pad for proper installation. The end user must check the local codes and ordinances for minimum depth required for safe installation.

Ordering Example: MP-612 / WRB9 / TSB-601 / TSB60. (4" x 12' Fluted Pole / Town Square Base / Single Sign Mount / Pole Topper)

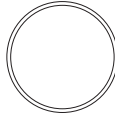
Pole Toppers: All Pole Toppers completely cover the top of the post to keep out the elements.

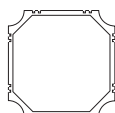

Poles: 4" O/D Extruded Aluminum Poles.

		Over All Pole Length				
		8' Length	10' Length	12' Length	14' Length	16' Length
  <p>Smooth Round offers a smooth, clean look</p>	Model # 608	Model # 610	Model # 612	Model # 614	Model # 616	
  <p>Fluted Round Fluted channels adds to the strength of the pole and presents a more upscale appearance</p>	MP-608	MP-610	MP-612	MP-614	MP-616	
  <p>Fluted Square Sculpted corners and accent flutes gives this pole a unique look</p>	MP-708	MP-710	MP-712	MP-413	N/A	

Bases: Bases fit over a 4" O/D poles to add a decorative touch to the pole. Made of cast aluminum with a powder coated finish.



WRB3
14" Height
7" Width

(For square post only)



WRB11
16" Height
13" Dia.



WRB9
Town Square Series
32" Height
11 3/4" Dia.

See pages 21-22 for more commercial light fixture options.

4" Pole - Street Sign Mounting

The TSB series of Street Sign Holders can be ordered to hold any size Sign Blade. Add the height and length of the Sign Blade in inches to the end of the item number of the desired sign. For example: for a 6" x 24" Sign Blade in a TSB601 bracket the item number would be TSB601-624. Length of the arm's bar will vary with the length of the Sign Blade. Sign Blades sold separately.

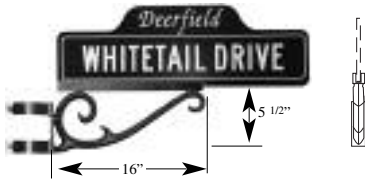

item# **TSCR-600**
for use with 4" O/D round poles
Scroll: 16" long
5 1/2" high



item# **TSCR-700**
for use with any Special Lite pole
Scroll: 16" long
5 1/2" high



item# **TSCR-600-DBL**
Two TSCR brackets welded together at a 90° angle. For use with 4" O/D round poles
Scroll: 16" long
5 1/2" high



item# **TSB-601**
for use with 4" O/D round poles
TSB601-624: holds 6" x 24" Street Blade
Scroll: 16" long
5 1/2" high



item# **TSB-601-DBL**
Two TSB-601 brackets welded together at a 90° angle. For use with 4" O/D round poles



item# **TSB-202**
for use with any Special Lite pole
TSB202-624: holds 6" x 24" Street Blade
Scroll: 16" long
5 1/2" high

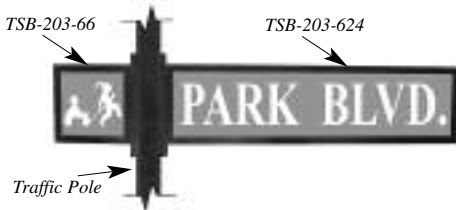

item# **TSB-203**
for use with any Special Lite pole
TSB-203-624: holds 6" x 24" Street Blade
Shown with a **TSB-203-66** Custom Frame
Custom Frames can be used to display logos and other images opposite street signs.



item# **TSB-605**
for use with 4" O/D round poles
TSB605-624: holds 6" x 24" Street Blade



item# **TSB-605-DBL**
Two TSB-605 brackets welded together at a 90° angle. For use with 4" O/D round poles



item# **TSB-608**
for use with 4" O/D round poles (shown mounted to smooth pole - sold separately.)



item# **TSB-608-DBL**
for use with 4" O/D round poles (shown mounted to smooth pole with TSB60 pole topper - both sold separately.)



item# **TSB-609**
for use with 4" O/D round poles (shown mounted to smooth pole with pole topper - both sold separately.)



item# **TSB-610**
for use with 4" O/D round poles (shown mounted to smooth pole - sold separately.)



As Shown:
MP-710 / TSB202 /
TSB11 / SF-24OCT

Street Sign Blades & Brackets

Pole top mounting brackets and finials

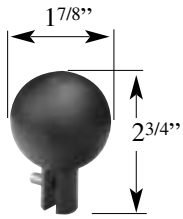

item# **TSB8**
Finial for
Flat Street Blade
item# **TSB8X**
Finial for
Extruded Street
Blade

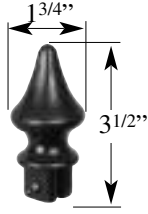

item# **TSB3**
Finial for
Flat Street Blade
item# **TSB3X**
Finial for
Extruded Street
Blade



Fits 3" O/D round posts.
Holds one Street Blade

item # **TRO** -for
Flat Aluminum Blades

item # **TRO-X** -for
Extruded Aluminum
Blades



Fits onto a Street Blade.
Holds one Street Blade

item# **DBL** -for
Flat Aluminum Blades

item # **DBL-X** -for
Extruded Aluminum
Blades



4" to 3"
Pole Adaptor
item# **TSB15**
Easily attach
3" O/D Finials
or Brackets to a
4" O/D Pole.

Street Sign Blades

- Custom lengths available on request
- .080 thickness and extruded blades
- Sign Blades and Lettering available in a wide variety of colors & fonts
- We can place Logos and Line Art images on the Sign Blades

Flat Aluminum

6" High Blade

By necessary length



9" High Blade

By necessary length



Extruded Aluminum Blade

6" High Blade

By necessary length

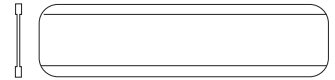

9" High Blade

By necessary length

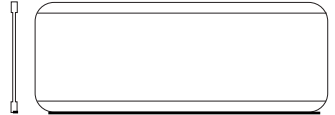

Custom Blade Designs available

- Special Lite Products can custom cut vinyl to give your basic street signs a unique look or custom cut metal blades to create logos or other designs to make your signs stand out from the rest.

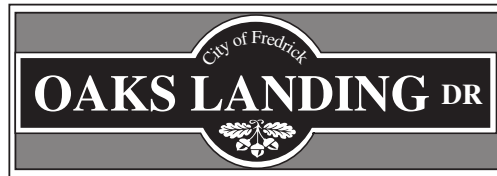

Traffic Sign Back Plates- Measurements are for the Sign Blade going onto the backplate. Backplates have a 1" wide edge on all sides. The Traffic back plates are provided undrilled for custom mounting. To order a custom backplate use the item number BP followed by the height then the width of the sign. For example: to order a Back Plate for a 24" x 30" sign the item number would be BP-2430.

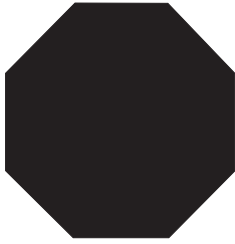

24" Back Plate BP-24-OCT
30" Back Plate BP-30-OCT



24" x 24" Back Plate BP-2424
30" x 30" Back Plate BP-3030



12" x 18" Back Plate BP-1218
18" x 24" Back Plate BP-1824

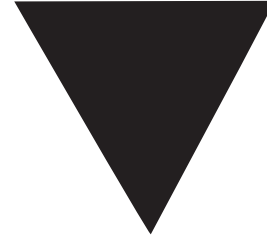

30" Back Plate BP30-TRI
36" Back Plate BP36-TRI
measurement is corner to corner

Traffic Sign Frames- Measurements are for the Sign Blade going into the frame. Sign Frames have a 1" square edge on all sides. To order a custom Sign Frame, use the item number SF followed by the height then the width of the sign. For example: to order a Frame for a 18" x 30" sign the item number would be SF-1830.



24" Frame SF24-OCT
30" Frame SF30-OCT



24" x 24" Frame SF-2424
30" x 30" Frame SF-3030



12" x 18" Frame SF-1218
18" x 24" Frame SF-1824



30" Frame SF30-TRI
36" Frame SF36-TRI
measurement is point to point

Mounting Brackets



item# **TSB1** - For 3" O/D Poles
item# **TSB61** - For 4" O/D Poles
Pole Sign Bracket/Hardware
(set of 2)



item# **TSB9** - For 3" O/D Poles
item# **TSB62** - For 4" O/D Poles
Sign Bracket/Hardware Back-to-Back Signage Mount
(set of 2)

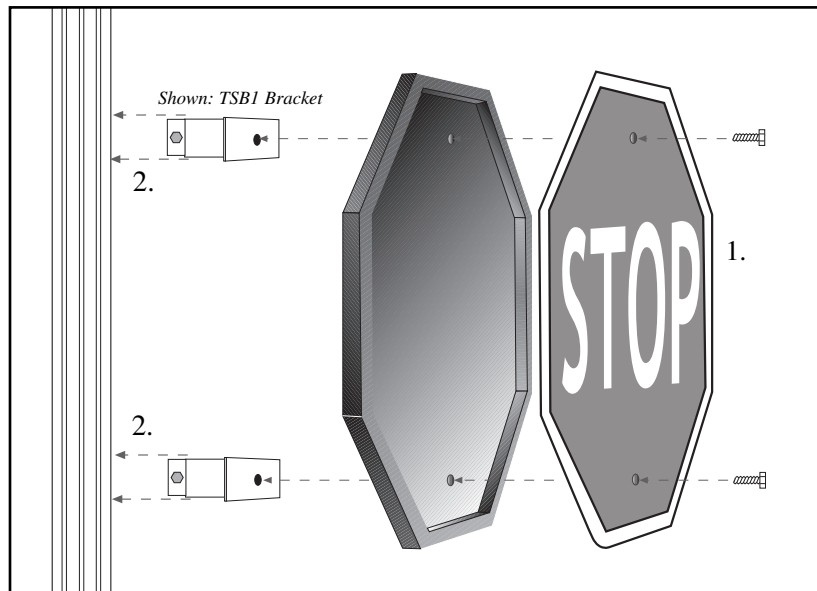

Frame and Back Plate mounting diagram



item# **TSB14** - For 3" O/D Poles
item# **TSB63** - For 4" O/D Poles
Pole Sign Bracket/Hardware
(set of 2)



*TSB14 and TSB63
Mounting Example*



TSB13
Vandal Proof Nuts
(pack of 10)

Special Purpose & Custom Signage

Custom Aluminum Signs for all your property needs.

- Available in economy priced non-reflective and reflective vinyls.
- Heavy-duty powder coated .080 aluminum sign blades
- No set-up charge (*custom logos must be provided in correct format to avoid production delays*)



A. CHOOSE YOUR SIZE:
Pick the size that will meet your specific needs.

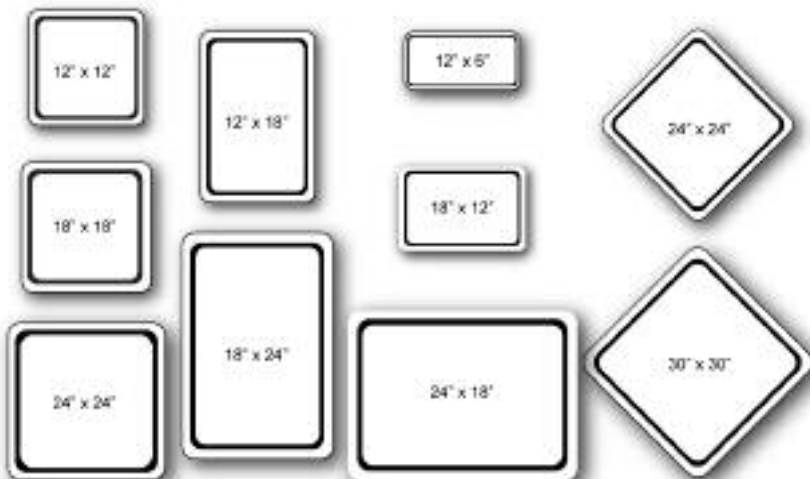

B. CHOOSE YOUR COLOR COMBO:
Pick from the choices below.

Background Color	Vinyl Color
1. Black	1. Black
2. White	2. White
3. Green	3. Green
4. Burgundy	4. Red
5. Mocha	5. Blue

C. CHOOSE YOUR Font:
Pick from the choices below.

Style #	
Arial	CUSTOM SIGN
Trajan	CUSTOM SIGN
Textile	CUSTOM SIGN

D. ADD YOUR LOGO OR FREE SYMBOL:
Choose from our symbol collection below or submit your own logo (*must be submitted as an Illustrator .EPS file.*)



Entrance Signage / Custom Signage

Specially designed area directional and entrance signs can be placed throughout your community or business complex to direct motorists, bicyclist and pedestrians to key locations. Standard and custom size signs available. Signs can be made from a variety of materials. Add decorative poles bases and toppers to create beautiful signage units for your community or commercial property. Call today for more information and pricing.



Lighted Address Plaques Give your home the mark of distinction with a bright and durable Lighted Address Plaque. Visible at over 100 feet away, these Low Voltage Address Plaques are made from Cast Aluminum or Rigid Polymer. These Plaques can be wired directly to your door bell transformer or plugged directly into a wall outlet with the optional Wall Outlet Transformer. Ten feet of Low Voltage wire is included with the Plaques. Choose up to five 4 inch black numbers per Lighted Address Plaque at the time of order. Cast Aluminum Address Plaque frames available in all Special Lite finishes.



Kingsport SAP-4210

14 1/2" W x 10 3/8" H
Cast Aluminum Frame



Manor SAP-4220

13 7/8" W x 8 7/8" H
Cast Aluminum Frame

Manor SAP-4230

13 7/8" W x 8 7/8" H
High Impact Polymer Frame
Black Finish only



Replacement Door Bell Transformer
DBT-4200



Wall Outlet Transformer
WOT-4200



Cast Aluminum Address Plaques

Our line of Cast Aluminum Address Plaques help you mark your home with a unique style. Solid cast aluminum and powder coated to withstand the elements, these beautiful plaques coordinate with our mailboxes and outdoor lighting fixtures. (Up to five 3" numbers in your choice of Polished Brass or Stainless Steel; specified at time of order.)



Colonial SAP-4170

12" W x 7 1/4" H
Available in all finishes
with Matching Background



Traditional SAP-4140

11 1/2" W x 6" H
Available in all finishes
with Matching Background



Boulevard SAP-4190

16 1/2" W x 11" H
Available in all finishes
with Matching Background



Floral SAP-4110

12 3/4" W x 9 1/2" H
Available in all finishes
with White Background



Classic SAP-4180

14 1/4" W x 10 1/2" H
Available in all finishes
with White Ceramic Background

Bollards Decorative Cast Aluminum Bollards can be used at key locations to create a sense of separation between pedestrian and vehicular areas and to add visual interest to the streetscape. Please specify if chain loops are required. Bollards ship standard without chain loops.

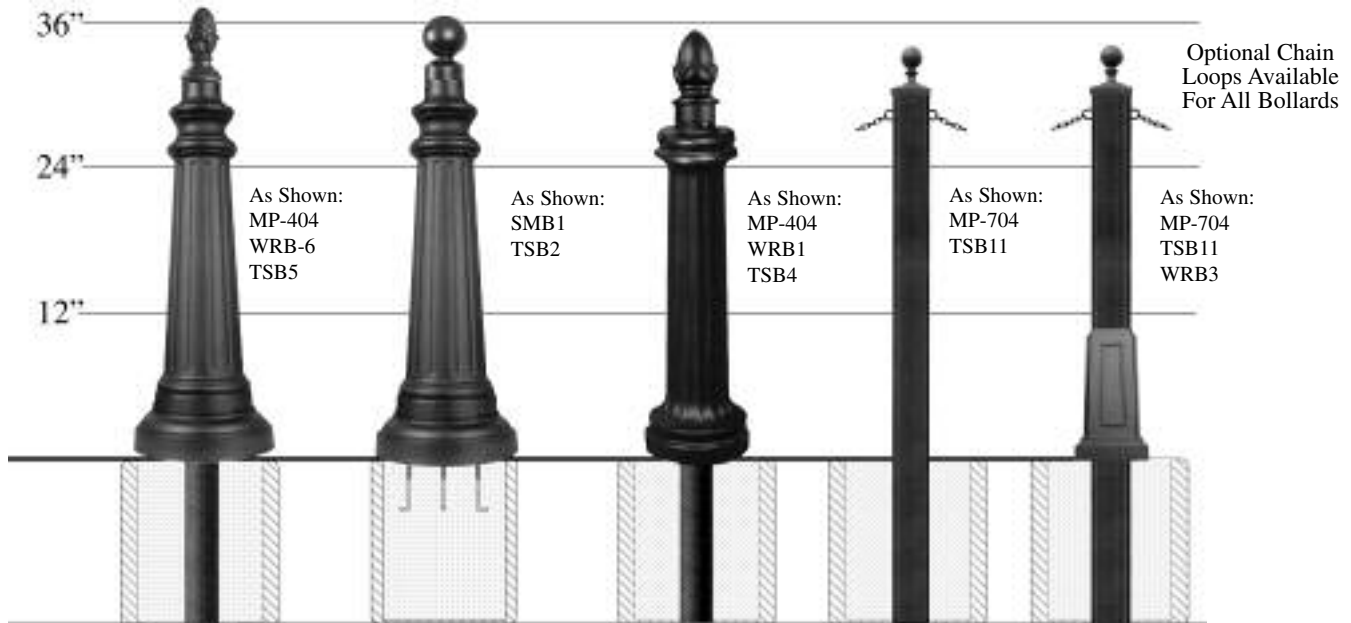

CRASH TESTS: We have not conducted nor do we intend to conduct a laboratory crash test. We do not boast or claim that given bollards will withstand any given force or impact for liability purposes. It would be comparable to saying all telephone poles or trees will withstand the same impact. Bollards are manufactured and designed as a deterrent and safety precaution.

Cluster Box Units

The Florence vital™ 1570 series cluster box unit design has been adopted by the USPS as the design standard for all CBUs manufactured in the United States. We are pleased to offer a complete line of USPS approved cluster box units to fit your individual project needs. We are proud to offer you the security and reliability that the USPS depends on every day.

Standard Features:

- * Robotically welded cabinet and hood seams
- * Rugged, weather resistant powder coat finish resists scratching and vandalism
- * Constructed of 300 series stainless steel and aircraft aluminum, including aluminum pedestal
- * Master front loading door designed to prevent prying with interlocking overlap seams
- * Solid aluminum mail slot frame, similar to Florence exclusive HSCBU design, protects adjacent customer compartment and collection compartment
- * Silver adhesive metal placards with black numbers 1-16 and 1P-2P

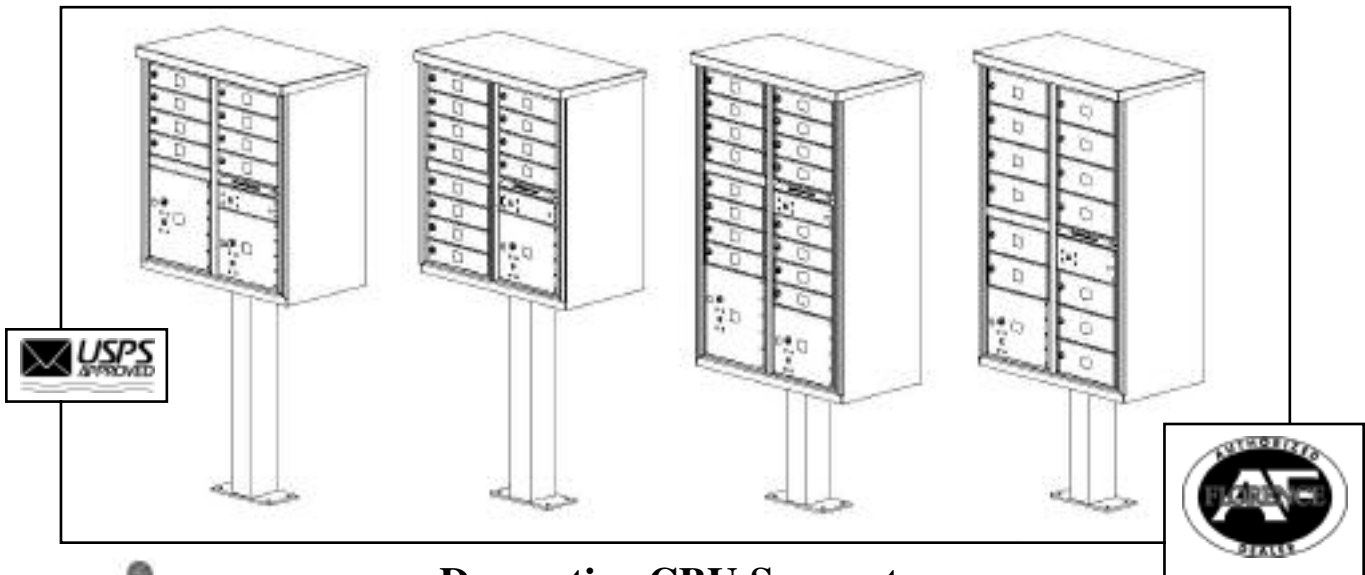

Decorative CBU Supports



Looking for a way to turn your standard CBU into something more “upscale”? Special Lite Products has created a CBU upgrade kit. This kit is designed to fit the most popular styles of CBUs and can be used as a retro fit or new installation.

Our kit features all cast/extruded aluminum construction, stainless steel screws, and a powder-coated finish. Installation is quick and easy.

Please contact us on pricing for your specific model.



Curbside Mailboxes *(See our catalog for our full line of mailboxes.)*

Berkshire Curbside

The Berkshire Mailbox presents an impressive face. The one piece cast aluminum door features deeply cut details with a rich, leather grain textured panel. The rust proof cast aluminum body construction creates a weather resistant mailbox and the stainless steel spring hinge and magnetic catch will keep the door secure.



The Berkshire is available with numerous Address Number options. We can install up to five 2" address numbers in Stainless Steel or Polished Brass on the door, up to five 3" numbers on the optional side panels or in both locations.

Description	Item #	Height	Width	Depth
Berkshire Curbside	SCB-1015	10"	9"	19 3/4"
Berkshire Curbside w/ Paper Tube	SCB-2015	15"	9"	19 3/4"

Town Square Curbside



Presenting a sleek modern design, the Town Square will complement both contemporary and traditional architecture perfectly. Combining modern design elements with classic styling, this mailbox is not an "off the shelf" mailbox and will improve the curb-appeal of your home.

Description	Item #	Height	Width	Depth
Town Square Curbside	STB-1007	10 3/4"	10 1/2"	21"
Town Square Curbside w/ Paper Tube	STB-2007	15 1/4"	10 1/2"	21"

Classic Curbside



The traditional shape of our Classic Mailbox is the only thing this mailbox has in common with a typical curbside mailbox. The solid cast aluminum construction, with thicker walls than our competitors, provides added strength, and the powder coated finish will maintain a lifetime of beauty.

Description	Item #	Height	Width	Depth
Classic Curbside	SCC-1008	10"	8 3/4"	20"
Classic Curbside w/ Paper Tube	SCC-2008	15"	8 3/4"	20"

Mailbox Posts: Each Cast Aluminum Mailbox Post has maintenance free Powder Coated base finish. Our Aluminum Mailbox Posts have an 18" burial portion to ensure a secure base for your mailbox.
(See our catalog for our full line of posts.)



SPK-600
Ashland Post
 Surface Mount or
 Direct Burial Post
 Overall Height: 62"
 Base Dia.: 7 1/2"



SPK-590
Bradford Post
 Direct Burial Post
 Overall Height: 58"
 Base: 8 1/2" Dia



SPK-651
Albion Post
 Direct Burial Post with
 Decorative Bracket
 Overall Height: 79"



SPK-700
Main Street Post
 4" Square Fluted Post
 Direct Burial Post
 Overall Height: 78"

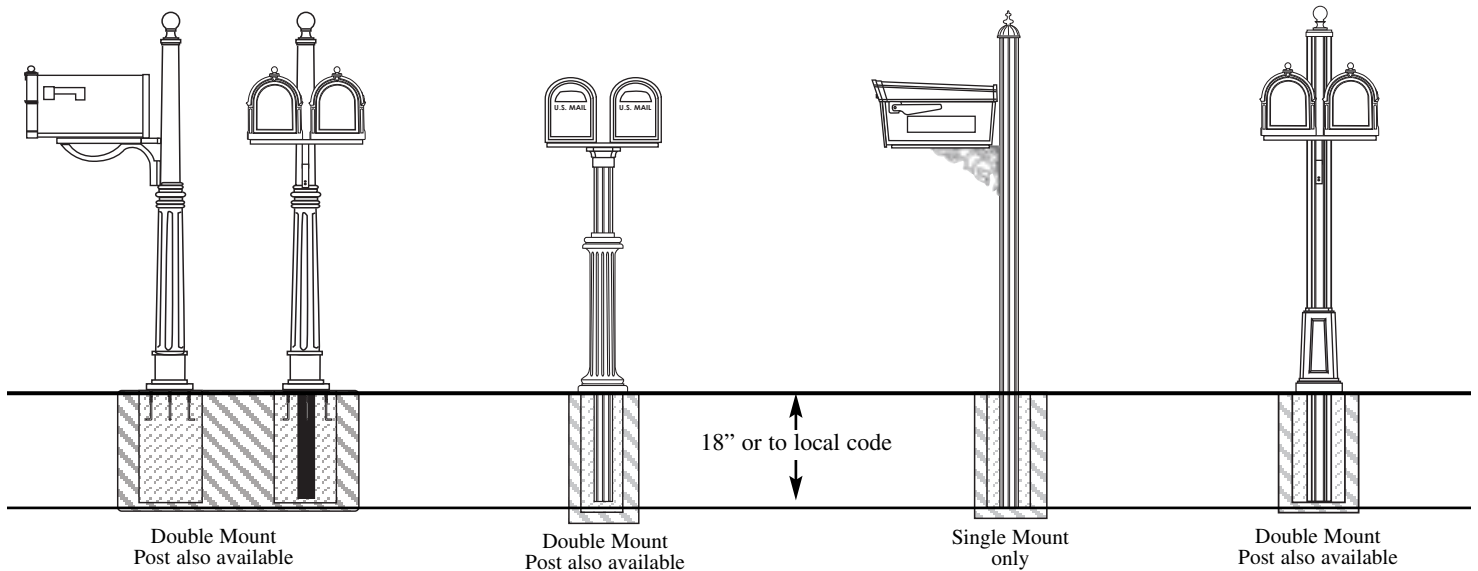

Commercial Lighting

Coordinated decorative street lighting will improve vehicular safety, while enhancing the visual image of the community. Special landscape areas and signage locations should be lit, as well as locations with unique features.

Whether you are a builder creating a master planned community or an architect developing a new lifestyle center, Special Lite Products offers the value you've been looking for. These are rust free and maintenance free outdoor lighting fixtures that increase property values and bring a decorative, uniform appearance to both old and new communities

We also offer several choices of Commercial Lighting Globes with several High Intensity Discharge lighting options. Lamp post choices available up to 16' in height.



Commercial Lighting Poles

Direct Burial Poles: Requires a minimum of 18" of the pole be submerged into the concrete pad for proper installation. The end user must check the local codes and ordinances for minimum depth required for safe installation.

Surface Mount Pole: The SMB1 and SMB2 Bases may be mounted to a concrete pad by means of "J"-bolts embedded in the concrete (*sold separately*).

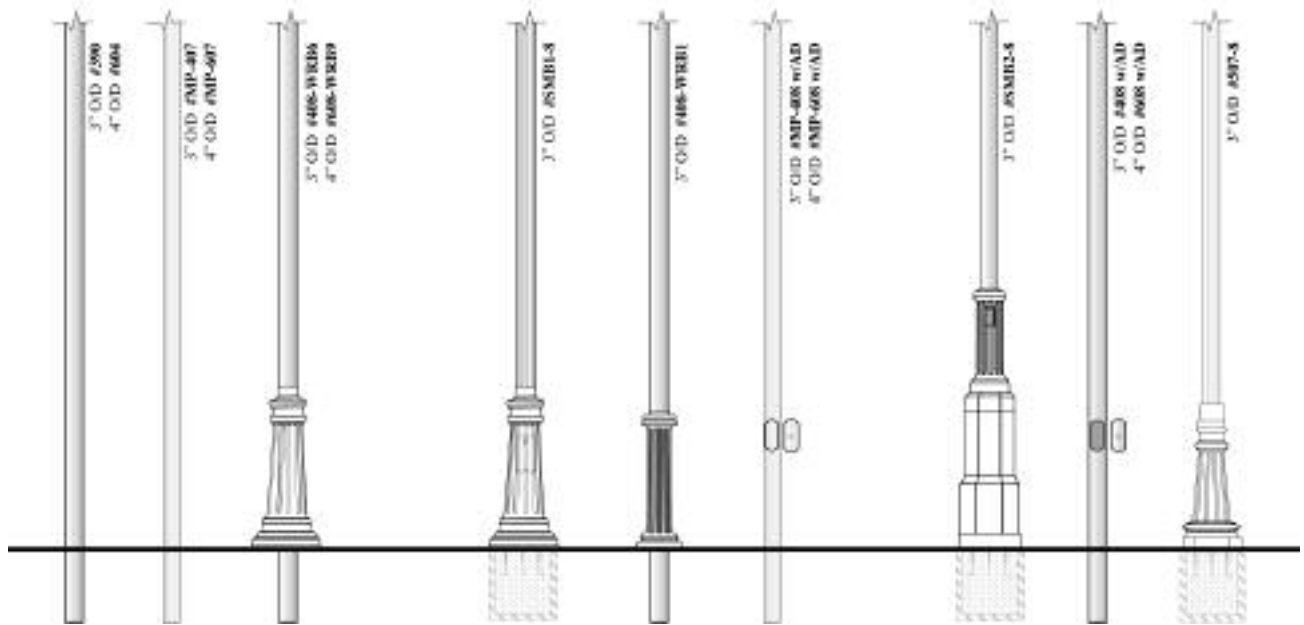

3" Pole Description and Available Model Numbers

Description	7' Model #	8' Model #	10' Model #	12' Model #	14' Model #	16' Model #
3" O/D Smooth Pole	390	408	410	412	414	416
3" O/D Fluted Pole	MP-407	MP-408	MP-410	MP-412	MP-414	MP-416
3" O/D Smooth Pole w/ WRB6 Base**	390-WRB6	408-WRB6	410-WRB6	412-WRB6	414-WRB6	416-WRB6
Surface Mount Base w/ 3" O/D Fluted Pole and Access Door	N/A	SMB1-8	SMB1-10	SMB1-12	SMB1-14	N/A
3" O/D Smooth Pole w/ WRB1 Base**	390-WRB1	408-WRB1	410-WRB1	412-WRB1	414-WRB1	416-WRB1
3" O/D Fluted Pole w/ Access Door	MP-407-w/AD	MP-408-w/AD	MP-410-w/AD	MP-412-w/AD	MP-414-w/AD	MP-416-w/AD
Surface Mount Base w/ 3" O/D Smooth Pole and Access Door	N/A	SMB2-8	SMB2-10	SMB2-12	SMB2-14	N/A
3" O/D Smooth Pole w/ Access Door	390-w/AD	408-w/AD	410-w/AD	412-w/AD	414-w/AD	416-w/AD
3" O/D Fluted Pole and Sculpted Base	N/A	507-8	507-10	507-12	N/A	N/A

4" Pole Description and Available Model Numbers

Description	7' Model #	8' Model #	10' Model #	12' Model #	14' Model #	16' Model #
4" O/D Smooth Pole	607	608	610	612	614	616
4" O/D Fluted Pole	MP-607	MP-608	MP-610	MP-612	MP-614	MP-616
4" O/D Smooth Pole w/ WRB9 Base**	607-WRB9	608-WRB9	610-WRB9	612-WRB9	614-WRB9	616-WRB9
4" O/D Fluted Pole w/ Access Door	MP-607-w/AD	MP-608-w/AD	MP-610-w/AD	MP-612-w/AD	MP-614-w/AD	MP-616-w/AD
4" O/D Smooth Pole w/ Access Door	607-w/AD	608-w/AD	610-w/AD	612-w/AD	614-w/AD	616-w/AD

** = Pole and Base are priced separately

Commercial Lighting

High Intensity Discharge Lighting or HID offers the advantages over incandescent lighting of increased energy efficiency, longer bulb life, and brighter light. We offer two **HID** light sources, High Pressure Sodium and Metal Halide. These quality lighting fixtures are manufactured from Cast Aluminum with enclosed ballast and stainless steel hardware. The Globe is held onto the fitter by four 1/4-20 set screws and the Ballast can be easily changed in the field by loosening two screws. Porcelain socket will be Medium or Mogul base. Lamp not included. TSB-15 (4" to 3" Pole Adaptor) required if using with a 4" O/D pole (*sold separately*).

Metal Halite

- Produces a pure white light
- Enormous amount of light with excellent color rendering
- Bulbs last six times longer than incandescent

High Pressure Sodium

- Produces a golden-pink cast
- Most efficient light source commercially available
- Bulbs rated at 24,000 hours

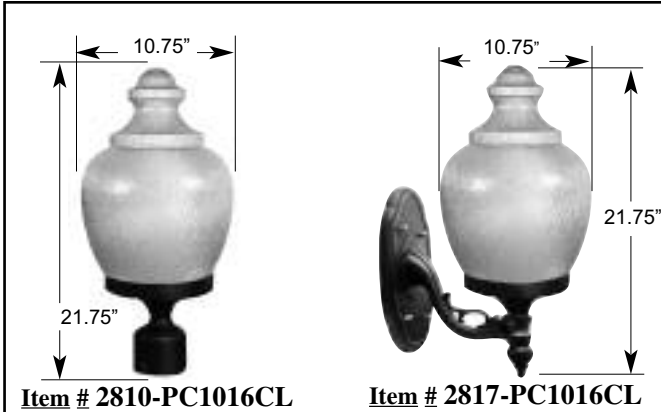

Item # 2810-PC1016CL

Item # 2817-PC1016CL

Acorn Light 16" Polycarbonate Globe

MODEL #: 2810-PC1016CL-INCAN
DESCRIPTION: INCANDESCENT - 300 Watt Max
VOLTAGE: 110
SOCKET: MEDIUM
For HID options see our Post Line Ballasts on page 26, HPS or MH 50w Max

MODEL #: 2817-PC1016CL-INCAN
DESCRIPTION: INCANDESCENT- 300 Watt Max
VOLTAGE: 110
SOCKET: MEDIUM

SHD1-PC1023CL High Pressure Sodium Acorn Light 23" Polycarbonate Globe

shown with a W8317

MODEL #	DESCRIPTION	VOLTAGE	SOCKET
SHD1-PC1023CL-INCAN	INCANDESCENT - Max 250 Watt	120	MEDIUM
SHD1-PC1023CL-50HPS	50 WATT HIGH PRESSURE SODIUM	120-277	MEDIUM
SHD1-PC1023CL-70HPS	70 WATT HIGH PRESSURE. SODIUM	120-208-240-277	MEDIUM
SHD1-PC1023CL-100HPS	100 WATT HIGH PRESSURE SODIUM	120-208-240-277	MEDIUM
SHD1-PC1023CL-150HPS	150 WATT HIGH PRESSURE SODIUM	120-208-240-277	MOGUL

Metal Halide Acorn Light 23" Polycarbonate Globe

Model #	Description	Voltage	Socket
SHD1-PC1023CL-50MH	50 WATT METAL HALIDE	120-277	MEDIUM
SHD1-PC1023CL-70MH	70 WATT METAL HALIDE	120-208-240-277	MEDIUM
SHD1-PC1023CL-100MH	100 WATT METAL HALIDE	120-208-240-277	MEDIUM

SHD1-PC1026CL High Pressure Sodium Acorn Light 26" Polycarbonate Globe

Model #	Description	Voltage	Socket
SHD1-PC1026CL-INCAN	INCANDESCENT - Max 250 Watt	120	MEDIUM
SHD1-PC1026CL-50HPS	50 WATT HIGH PRESSURE SODIUM	120-277	MEDIUM
SHD1-PC1026CL-70HPS	70 WATT HIGH PRESSURE SODIUM	120-208-240-277	MEDIUM
SHD1-PC1026CL-100HPS	100 WATT HIGH PRESSURE SODIUM	120-208-240-277	MEDIUM
SHD1-PC1026CL-150HPS	150 WATT HIGH PRESSURE SODIUM	120-208-240-277	MEDIUM
SHD1-PC1026CL-250HPS	250 WATT HIGH PRESSURE SODIUM	120-208-240-277	MOGUL

Metal Halide Acorn Light 26" Polycarbonate Globe

Model #	Description	Voltage	Socket
SHD1-PC1026CL-50MH	50 WATT METAL HALIDE	120-277	MEDIUM
SHD1-PC1026CL-70MH	70 WATT METAL HALIDE	120-208-240-277	MEDIUM
SHD1-PC1026CL-100MH	100 WATT METAL HALIDE	120-208-240-277	MEDIUM
SHD1-PC1026CL-150MH	150 WATT METAL HALIDE	120-208-240-277	MEDIUM

SHD3-PC1026CL Metal Halide Acorn Light 26" Polycarbonate Globe

Model #	Description	Voltage	Socket
SHD3-PC1026CL-175MH	175 WATT METAL HALIDE	120-208-240-277	MOGUL
SHD3-PC1026CL-250MH	250 WATT METAL HALIDE	120-208-240-277	MOGUL

See pages 23 & 24 for Type III, Type V, Prismatic Globe, House Shields and Night Sky Friendly Accessories.

Commercial Sphere Lighting

Cast Aluminum fixture with enclosed ballast and stainless steel hardware. Ballast can be easily changed in the field by loosening two screws. Porcelain socket will be Medium or Mogul base. Spherical Replacement Globes are available in White or Clear Finishes Lamp not included. TSB-15 (4" to 3" Pole Adaptor) required if using with a 4" O/D pole (*sold separately*).



↑ Fitter-3" Tenon

Item #

SHD2-PC3018WH

Globe available in White and Clear finishes.

High Pressure Sodium Sphere Light - 16" White Polycarbonate Globe			
Model #	Description	Voltage	Socket
SHD2-PC3016WH-INCAN	INCANDESCENT - 300 Watt Max	120	MEDIUM
SHD2-PC3016WH-50HPS	50 WATT HIGH PRESSURE SODIUM	120-277	MEDIUM
SHD2-PC3016WH-70HPS	70 WATT HIGH PRESSURE. SODIUM	120-208-240-277	MEDIUM
SHD2-PC3016WH-100HPS	100 WATT HIGH PRESSURE SODIUM	120-208-240-277	MEDIUM
SHD2-PC3016WH-150HPS	150 WATT HIGH PRESSURE SODIUM	120-208-240-277	MOGUL

Metal Halide Sphere Light - 16" White Polycarbonate Globe			
Model #	Description	Voltage	Socket
SHD2-PC3016WH-50MH	50 WATT METAL HALIDE	120-277	MEDIUM
SHD2-PC3016WH-70MH	70 WATT METAL HALIDE	120-208-240-277	MEDIUM
SHD2-PC3016WH-100MH	100 WATT METAL HALIDE	120-208-240-277	MEDIUM

High Pressure Sodium Sphere Light - 18" White Polycarbonate Globe			
Model #	Description	Voltage	Socket
SHD2-PC3018WH-INCAN	INCANDESCENT - 400 Watt Max	120	MEDIUM
SHD2-PC3018WH-50HPS	50 WATT HIGH PRESSURE SODIUM	120-277	MEDIUM
SHD2-PC3018WH-70HPS	70 WATT HIGH PRESSURE. SODIUM	120-208-240-277	MEDIUM
SHD2-PC3018WH-100HPS	100 WATT HIGH PRESSURE SODIUM	120-208-240-277	MEDIUM
SHD2-PC3018WH-150HPS	150 WATT HIGH PRESSURE SODIUM	120-208-240-277	MOGUL

Metal Halide Sphere Light - 18" White Polycarbonate Globe			
Model #	Description	Voltage	Socket
SHD2-PC3018WH-50MH	50 WATT METAL HALIDE	120-277	MEDIUM
SHD2-PC3018WH-70MH	70 WATT METAL HALIDE	120-208-240-277	MEDIUM
SHD2-PC3018WH-100MH	100 WATT METAL HALIDE	120-208-240-277	MEDIUM

HID Light Output

Item #	Wattage	Light Output (lumens)	Lamp Life (hours)	Item #	Wattage	Light Output (lumens)	Lamp Life (hours)
MH-50	50	1,900	24,000	HPS-50	50	1,900	24,000
MH-70	70	2,050	16,000	HPS-70	70	2,050	16,000
MH-100	100	4,300	24,000	HPS-100	100	4,300	24,000
				HPS-150	150	5,000	24,000

110 Volt Sphere Lighting

- 3" Standard Cast Aluminum Fitters with Medium Base Sockets

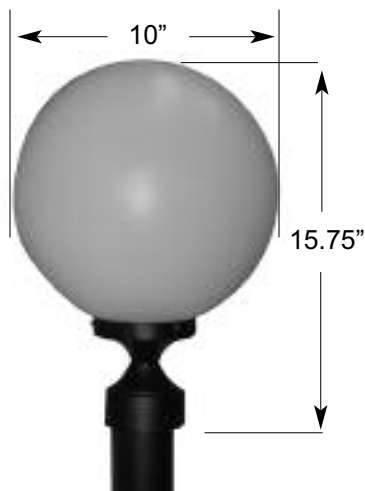

Item #

2790-AC3010 (shown)

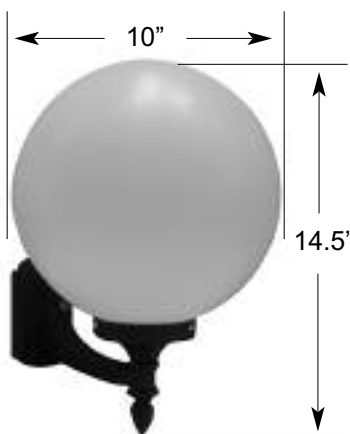

Item #

2797-AC3010 (shown)

White Acrylic Sphere Lites

(available in 10" and 12" Dia.)

Acrylic globes possess low impact strength, medium heat resistance and offers good weatherability when exposed to UV.

- Medium Base Socket Standard.
- Maximum Wattage is 100 Watts
- Incandescent
- Not available in H.I.D.

Available Products:

2790-AC3010	Post Mount 10" Globe
2790-AC3012	Post Mount 12" Globe
2797-AC3010	Wall Mount 10" Globe
2797-AC3012	Wall Mount 12" Globe

Replacement Polycarbonate & Acrylic Globes

We can supply a complete line of replacement O.E.M. street light globes. Traditional acorn globes are available in textured clear and Sphere globes are offered in clear and white.

In addition we offer a complete line of today's state of the art Acrylic Prismatic globes with the latest Internal reflector technology. Our Prismatic globes are available in several different light distribution patterns.

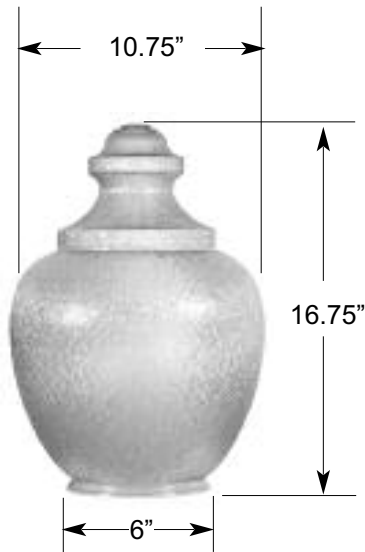

Item # **PC1016CL**

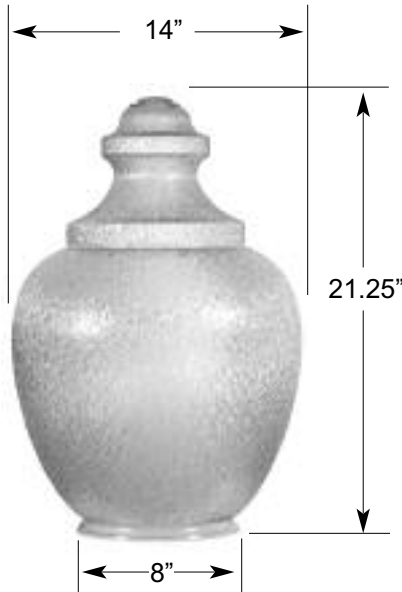

Item # **PC1023CL**



Item # **PC1026CL**

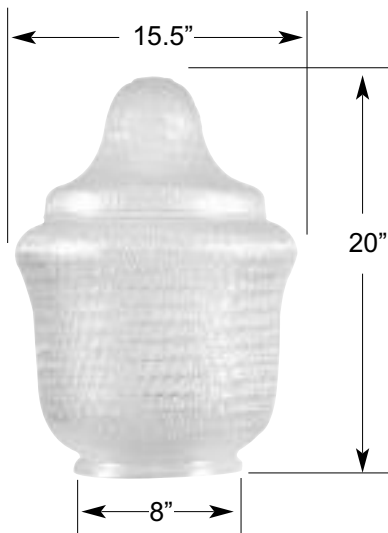

Item # **PC2020CL**

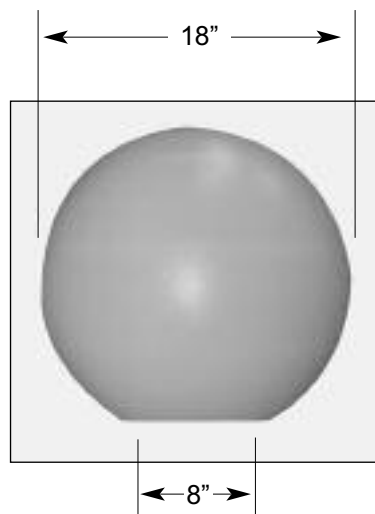

Item # **PC3016WH** White Globe

Item # **PC3018WH** White Globe

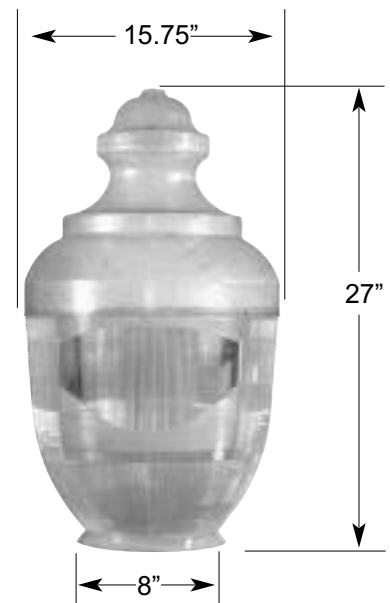

Item # **AC1026CL** Type III Distribution

Item # **AC1026CL** Type V Distribution

Optics



Type III Distribution



Type V Distribution

Accessories-Accessorize your street lights to better service your community. Add appeal with our variety of light arms, direct light with 90 degree or 180 degree house shields, or add dusk to dawn controls or an electrical outlet to your street lights. We even have a decorative finial for an acorn globe.

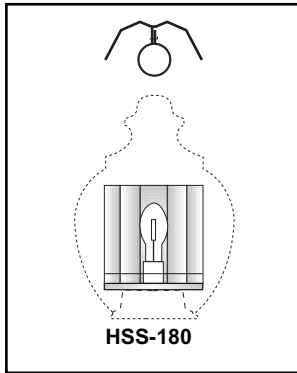

HSS-180

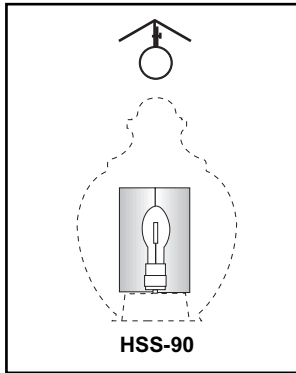

HSS-90

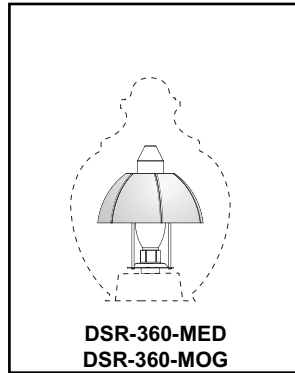

DSR-360-MED
DSR-360-MOG

House Shields

House side shields are available to cutoff all direct light through certain horizontal angles. Both models clamp around the socket and are designed to be positioned in the field after installation of the fixture. Fits medium base socket unless other option is specified.

Item #

HSS-180 (180 degree cutoff)
8.5" H x 6 7/8" W

HSS-90 (90 degree cutoff)

7 15/16" H x 4 5/8" W

(Dark Sky Reflector) 15" H x 11" W

DSR-360-MED

DSR-360-MOG

Lamp Arms

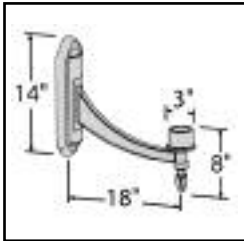

Lighting Arm
Item # W8317

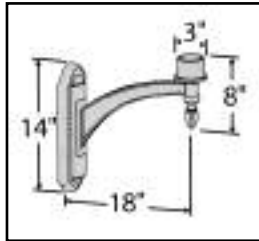

Lighting Arm
Item # W8311

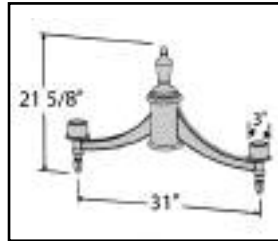

Lighting Arms
Item #P8327

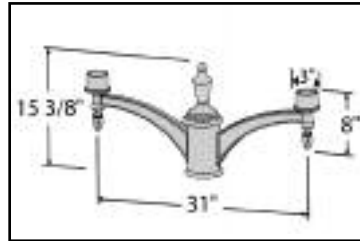

Lighting Arms
Item # P8321

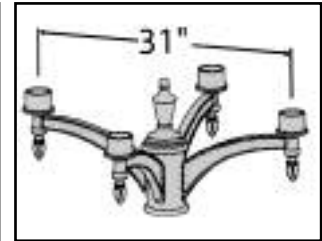

Lighting Arms
Item # P8341

Misc. Accessories



3" Acorn Fitter
Item # SHD1

Medium Base Socket
120 Volt Accepts Acorns
w/ 8" Neck



3" Sphere Fitter
Item # SHD2

Medium Base Socket
120 Volt Accepts
Sphere Globes w/ 8"
Neckless Opening



3" Acorn Fitter
Item # SHD3

Mogul Base Socket
120 Volt Accepts
Acorns w/ 8" Neck

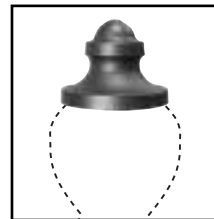

Solid Roof

Item # SR

Spun Aluminum will match
fixture finish unless otherwise
indicated. Available with
PC-1023 & PC-1026. Add SR
to the end of the item #
when ordering.



**Finial for Acorn
Diffusers**

(Polycarbonate)

Item # PFIN

Decorative finial for
use on top of acorn
diffusers. Available
in black only.



**SPB-190
Heavy Duty
Welded
Aluminum
Flange Base.**

For poles up to
14'. For 3.00"
OD posts only.
Anchor bolts
not included.
(pole sold separately)



**Post Electrical
Outlet**

Item # CO-268

Curved to fit 3" O/D
post. 1 1/4" hole
required. 120 Volt only.



**Dusk to Dawn
Photo Electric
Control**

Item # PC-8010

3/4" hole required.
120 Volt only.



Stub Post Cover

Item # SPC-191

For use with SPB-190



Stub Post Base

Item # SPB-190

(8" Tall, 10" Dia.)

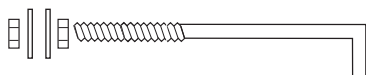

J-bolts-item# SMBJ12

Set of three J-Bolts

Includes washers and nuts.

Dark Sky Reflector- This product meets both old and new IES criteria for Uplight minimization. The amount of "Cut Off" you require can be achieved through the proper positioning of this component. With three standard mounting heights and unlimited possibilities, you can achieve maximum usable light while still allowing only a minimal amount of Uplight. Use with most Traditional Streetlamps, Globes & Acorns (for neck size 8" or larger, 7" min opening.)

- High Downlight Efficiency
- Low Uplight Levels
- Ideal For Retrofits
- Easy To Install, Self Collapsing Design

- Easy Access for Lamp Replacement
- Made of High Heat Resin
- Self Positioning & Leveling
- Adjustable Light Output Levels
- **Use With 175W MH Max (237°F / 114°C)**

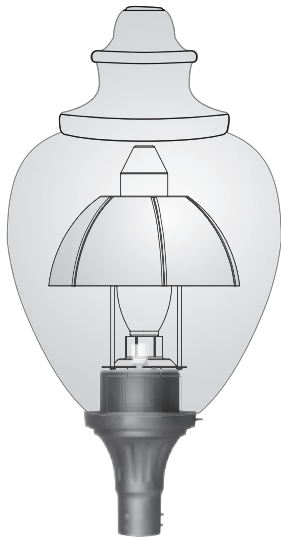

Item #
DSR-360-MED (fits overmedium socket)
DSR-360-MOG (fits over mogul socket)

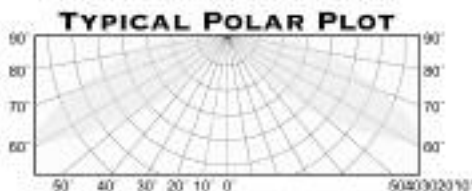
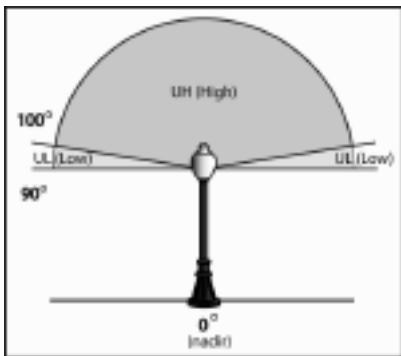

	Dark Sky Reflector
FORWARD LIGHT	
LUMINAIRE LUMENS	4493.7
%LAMP LUMENS	29.96%
FL (0°-30°)	0.95%
FM (30°-60°)	9.91%
FH (60°-80°)	15.70%
FVH (80°-90°)	3.41%
BACK LIGHT	
LUMINAIRE LUMENS	4493.7
%LAMP LUMENS	29.96%
BL (0°-30°)	0.95%
BM (30°-60°)	9.91%
BH (60°-80°)	15.70%
BVH (80°-90°)	3.41%
UPLIGHT	
LUMINAIRE LUMENS	5140.8
%LAMP LUMENS	6.44%
UL (90°-100°)	2.28%
BVH (100°-180°)	4.16%
TRAPPED LIGHT	
LUMINAIRE LUMENS	5046.0
%LAMP LUMENS	33.64%
TOTAL LIGHT EFFICIENCY	66.3%
DOWNWARD LIGHT EFFICIENCY	60.0%
UPWARD LIGHT LOW (UL)	2.28%
UPWARD LIGHT HIGH (UH)	4.16%
MAX CANDLEPOWER ZONE	62.5°

CAUTION: Product should not be exposed to temperatures exceeding 237°F / 114°C (MAX Lamp 175W Metal Halide).

H.I.D. Ballasts

HIGH PRESSURE SODIUM AND METAL HALIDE

Turn Special Lite's decorative outdoor post lights into H.I.D. light fixtures with an H.I.D. Ballast. All ballasts shown are designed to fit inside 3" and 4" O.D. posts. All ballasts are provided with a metal hanger strap for suspension inside the top of the post.



MH-50

Metal Halide

- Produces a pure white light
- Enormous amount of light with excellent color rendering
- Bulbs last six times longer than incandescent

HPS-35 / HPS-50 / HPS-150

High Pressure Sodium

- Produces a golden-pink cast
- Most efficient light source commercially available
- Bulbs rated at 24,000 hours

Item #	Wattage	Light Output (lumens)	Lamp Life (hours)
MH-50	50	1,900	24,000
HPS-35	35	2,050	16,000
HPS-50	50	3,600	24,000
HPS-150	150	5,000	24,000

HID Lighting is available on all single post mounted lanterns or as a separate kit to retrofit an existing light.

The Kit contains: Canister Ballast

Mounting Bracket

Heavy Duty medium base socket

Bulbs sold separately

With a post lamp:

Specify type of ballast using corresponding products number, then the fixture number, finish, and glass choice.

Example: MH50-2730-BL-BV

Not for use with Tri-Lights or Combination Twin Lanterns.

Kit by itself:

Specify type of ballast using corresponding products number.

Example: MH50



Beaumont Post Light



Madison Post Light



Astor Post Light

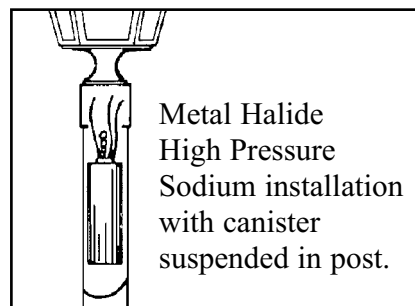

Metal Halide High Pressure Sodium installation with canister suspended in post.

Add a decorative touch to your street lighting. Ballasts available for most of our decorative outdoor residential lighting fixtures.



1634 Latrobe-Derry Road
Loyalhanna, PA 15661
Phone 724-537-4711
Fax 724-537-9313

www.specialliteproducts.com

customer_service@specialliteproducts.com

Design Theme

To create a distinct, consistent, and high-quality appearance for your community, a coordinated streetscape design theme should be established that addresses roadway frontages, streets, driveways, parking lots, individual homes, and public spaces. The following elements should be included in that overall design.

- Decorative Street/Traffic Signage
- Directional Signage
- Informational Signage
- Bollards
- Residential Outdoor Lighting
- Address Plaques
- Decorative Street Lighting
- Mailboxes
- Mailbox Posts
- HID Lighting
- Dark Sky Reflectors