









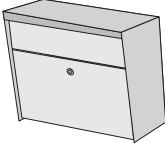

Congratulations on the purchase of your Mail Boss™ Metro security mailbox. The Metro is designed with your security and convenience in mind. This mailbox is constructed of tough, vandal resistant, 16 gauge galvanized steel. Your Metro mailbox comes with a unique mounting bracket which makes installation fast and easy. This product is designed to be installed on an exterior wall of your home. If desired the Metro can also be mounted on a freestanding post or on an appropriate surface such as a fence rail. The Metro mailbox is designed with a large internal volume so that more than several days of mail can be securely stored inside. If this mailbox was purchased without a post and you desire to install this mailbox on a new color matched steel post, you may purchase one online at www.themailboss.com. Posts are shipped via 3-6 day service but can be rush shipped for an additional fee.

On this insert you will find a list of hardware parts as well as detailed installation instructions. Installation on wood surfaces is quite simple and requires only a phillips head screwdriver a drill, and some caulk. Installation on a masonry surface requires a phillips screwdriver, a masonry drill bit, a drill, 5 masonry screws or anchors and some caulk. Installation on a metal post requires only a crescent wrench or box wrench. Installation will be most easily accomplished if you take *the time* to carefully sort the hardware and familiarize yourself with the function of each piece.

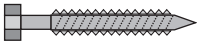
If you require assistance with assembly or part replacement, or for any other matter, contact the toll-free Epoch Design Service Center from anywhere in the Continental United States, Monday through Friday, 9AM - 5PM Pacific Standard Time at 1-800-589-7990. You may also email your request or comments to customerserv@themailboss.com and a service representative will respond. You can also find helpful hints and tips on our website: <http://www.themailboss.com>.

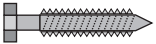
Thank you

Parts and Hardware List

Qty	Part		Use
1	Metro mailbox		Locking security mailbox.
1	Mail Flag		To notify postman of outgoing mail to be picked up.
1	Mounting Bracket		Mounting bracket for Metro.
6	Plastic Bushings		Used to optimize mounting on irregular surfaces.
5	2 1/4" mounting screw		Used to connect Metro to a wooden exterior wall.
3	Washers		Used with 2 1/4" mounting screws.
4	1 1/2" lag screw		Used to connect Metro to a wood post.
3	Security key		Used to lock and unlock your Metro.
1	1/8" drill bit		Used to drill 1/8 diameter hole (in wood).
1	Reflective adhesive house numbers		Used to identify and label your mailbox.

Installation of Metro mailbox onto a bevel sided/shingled exterior wall

- Using the hole template on this instruction sheet, lay out the top two holes on the wall at about 55" to 65" high. You may adjust the height up or down to your preference. If mounting onto bevel siding, position the top holes about 3/4" to 1 1/2" away from the peak of the bevel so as not to split the wood. Also adjust up or down a little to make sure bottom hole does not line up on the edge of bevel. The top two holes should be close to level. Mark the top hole locations.

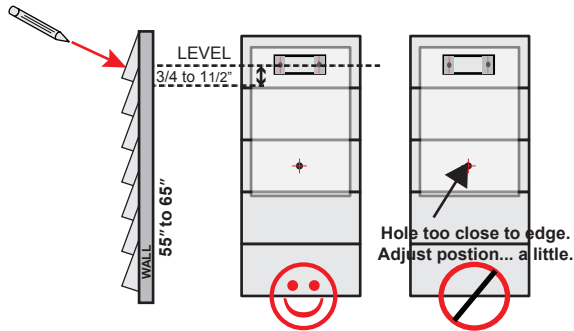

- Using a 1/8" drill bit, drill the top two pilot holes approximately 2" deep into the wall material. Attach the mounting bracket using the two 2 1/4" screws provided. Be sure to put some water resistant caulk into the holes. Now hang the Metro from the brackets shown and mark the bottom three holes with a pencil.

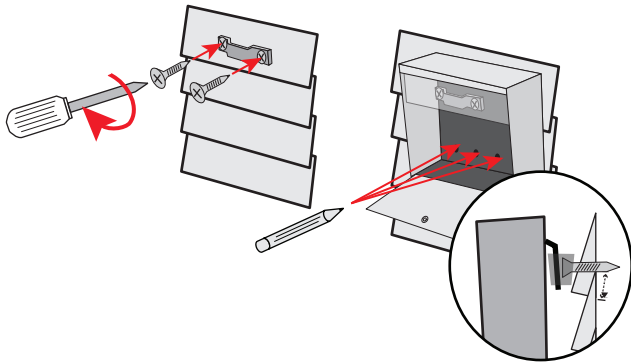

- Using a 1/8" drill bit, drill the bottom three pilot holes approximately 2" deep into the wall material. Now hangy our Metro from the the mounting bracket. If there is a large gap between the Metro and the wall insert a bushing on the screw. Insert some water resistant caulk into the hole and secure to bottom using the remaining three 2 1/4" screws provided.

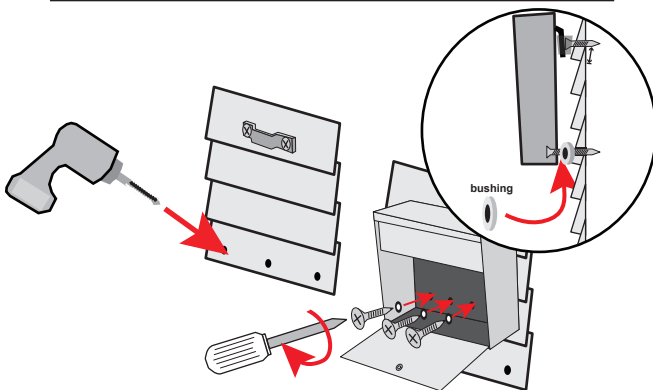

- Locate the carrier flag and remove the sticky sided tape shield from the back. Making sure the mailbox is clean, apply pressure while attaching the flag as shown, about 1/2" inch back from the front and top corners of the box.

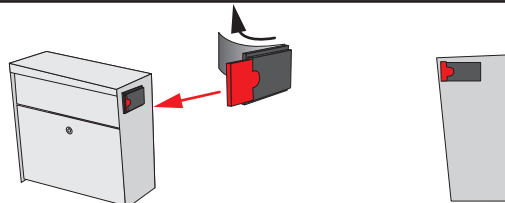

Installation of Metro mailbox onto stucco or masonry.

(for EIFS "faux" stucco, consult EIFS manufacturer)

- Using the hole template on this instruction sheet, lay out the top two holes on the wall at about 55" to 65" high. You may adjust up or down to your preference. Mark the top hole locations. Make sure the two holes are level.

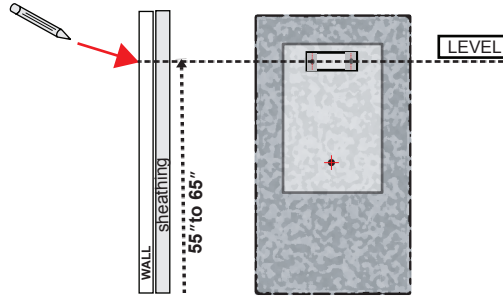

- Using a masonry style drill bit(not provided), drill the top two pilot holes approximately 2" deep into the wall material and into the sheathing. Attach the mounting bracket using the two 2 1/4" screws provided. If the wall is a thick concrete, stucco, brick or some other system, you will probably have to use masonry screws or anchors. Consult a contractor if necessary. Be sure to use a water resistant caulk in the holes to keep moisture out. Hang the Metro from the bracket as shown and mark the bottom three holes with a pencil.

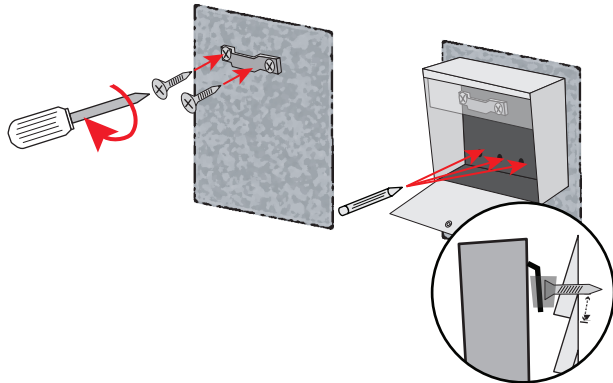

- Using a masonry style drill bit(not provided), drill the bottom three pilot holes approximately 2" deep into the wall material. Now hang the Metro from the mounting bracket and secure to bottom using the three 2 1/4" screws provided. Be sure to put some weather resistant caulk into the holes. If your wall is a thick brick, stucco or concrete you may need masonry screws or anchors for attachment. Consult a contractor if necessary.

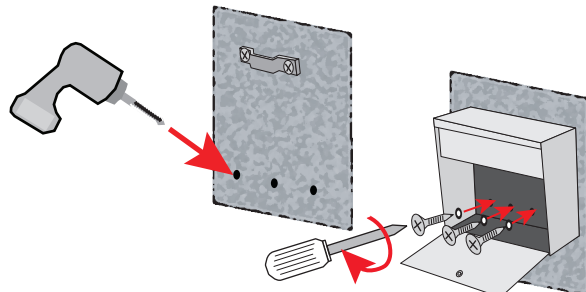

INSTALLATION INSTRUCTIONS

If installing street side, customers are required to contact the local post office prior to installation to ensure correct placement and height of the mailbox at the street. Generally, mailboxes are installed at a height of 41- 45 inches from the road surface to the inside floor of the mailbox or point of mail entry, and are set back 6 - 8 inches from the front face of the curb or road edge to the mailbox door.

Installation of Metro onto a wood post or rail

- 1 Locate the four mounting holes on the floor of the Metro. Position the holes over the wood surfaces so that the front door can freely swing open. Mark the hole position onto the wood with a pencil or pen.

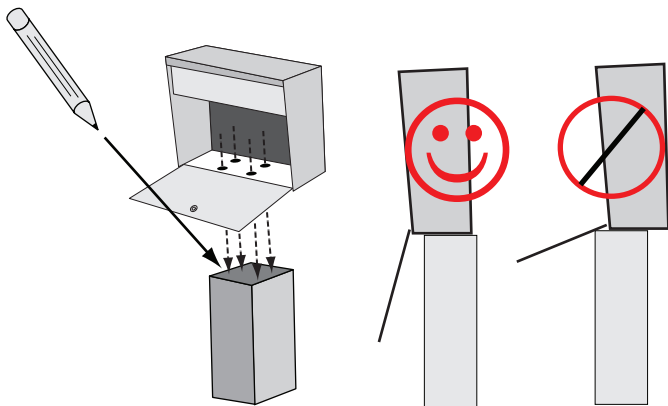

- 2 Using a 1/4" drill bit, drill four pilot holes in the marked positions approximately 1 1/2" deep into the wood. Attach the Metro to the post using four 1 1/2" lag screws. A 1/2" drive socket or a 1/2" wrench may be used.

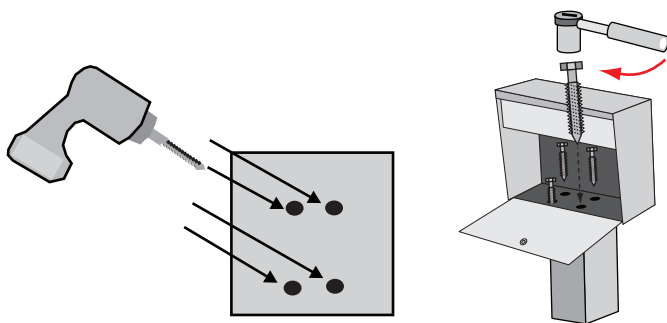

Installation of Metro onto a Mail Boss steel post

- 1 Locate the four mounting holes on the floor of the Metro. Position the holes over the Mail Boss steel post. Insert the four machine bolts (bolts provided with post) through the base of the Metro.

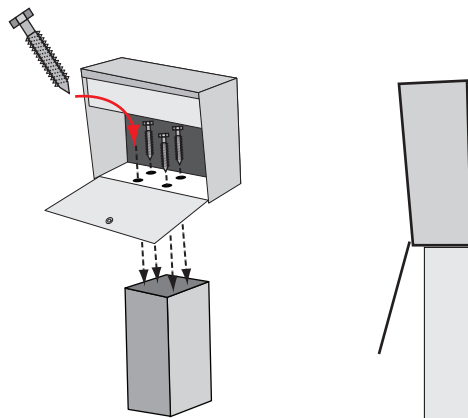

- 2 Secure the Metro to the post using a 1/2" drive socket or a 1/2" wrench.

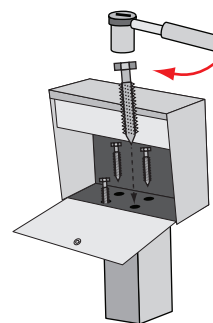

- 3 Locate the mail flag and remove the sticky sided tape shield from the back. Making sure the mailbox is clean, attach the flag applying pressure as shown, about 1/2" back from the front and top corners of the box.

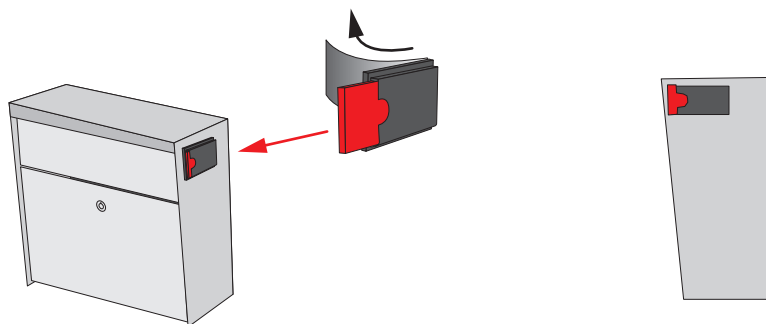

Have a question?.. Need a part ASAP?..1-800-589-7990