

Cluster Box Units (CBU's) - continued on pages 8-11

CLUSTER BOX UNITS - FRONT LOADING

Made of heavy duty aluminum and stainless steel hardware, Salsbury 3300 series U.S.P.S. approved Cluster Box Units (CBU's) are accessed from the front through two (2) easy opening master door panels. The durable and corrosion resistant units feature a powder coated finish available in six (6) contemporary colors. Each CBU includes one or two (2) fully integrated parcel lockers and a matching pedestal. Each aluminum door includes a heavy duty five (5) pin cylinder cam lock with a dust/rain shield and three (3) keys. One additional compartment in each unit is labeled "Outgoing Mail" and includes a weather protection flap and an 11-3/4" W x 3/4" H mail slot. An attractive option to CBU's for new and existing CBU installations are Salsbury 3300R series U.S.P.S. approved Regency Decorative CBU's - see pages 8-9.



3308
Type I

Matching pedestals are included with Cluster Box Units

includes pedestal



Officially Licensed by the U.S.P.S.

Salsbury 3300 series Cluster Box Units are manufactured to U.S.P.S. "F" specifications. They are an officially licensed product of the U.S. Postal Service for centralized mail delivery.



#3316 in sandstone finish displayed

• 3300 Series CBU Door Sizes



#3351 ¹ Replacement "A" door and lock
\$40.00

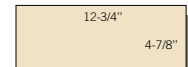

#3352 ¹ Replacement "B" door and lock
\$50.00

• Fully Integrated Parcel Lockers

For matching stand-alone Outdoor Parcel Lockers (OPL's) (#3302), see page 60.

• Regency® Decorative CBU's Available

Includes CBU and matching pedestal, decorative CBU top and decorative pedestal cover - see pages 8-9.





CLUSTER BOX UNITS - INCLUDES CBU AND PEDESTAL - U.S.P.S. APPROVED

MODEL	DESCRIPTION	UNIT SIZE	WEIGHT	PRICE
CLUSTER BOX UNITS				
3308 ^{1,2}	Cluster Box Unit (CBU) - 8 "A" Size Doors - Type I (8) "A" mail compartments (2) parcel lockers (1) pedestal	30-1/2" W x 62-3/4" H x 18" D 12" W x 3" H x 15" D (1) 12" W x 13-1/2" H (1) 12" W x 10" H 28-1/2" H base 12" W x 12" D	145 lbs.	\$1,150.00
3312 ^{1,2}	Cluster Box Unit (CBU) - 12 "A" Size Doors - Type II (12) "A" mail compartments (1) parcel locker (1) pedestal	30-1/2" W x 62-3/4" H x 18" D 12" W x 3" H x 15" D 12" W x 10" H 28-1/2" H base 12" W x 12" D	145 lbs.	\$1,200.00
3316 ^{1,2}	Cluster Box Unit (CBU) - 16 "A" Size Doors - Type III (16) "A" mail compartments (2) parcel lockers (1) pedestal	30-1/2" W x 62-3/4" H x 18" D 12" W x 3" H x 15" D (1) 12" W x 13-1/2" H (1) 12" W x 10" H 14-1/2" H base 12" W x 12" D	175 lbs.	\$1,250.00
3313 ^{1,2}	Cluster Box Unit (CBU) - 13 "B" Size Doors - Type IV (13) "B" mail compartments (1) parcel locker (1) pedestal	30-1/2" W x 62-3/4" H x 18" D 12" W x 4-3/4" H x 15" D 12" W x 10" H 14-1/2" H base 12" W x 12" D	165 lbs.	\$1,225.00

SPARE PARTS / OPTIONS

3385 ¹	Pedestal - replacement for #3316 and #3313	14-1/2" H base 12" W x 12" D	15 lbs.	\$100.00
3395 ¹	Pedestal - replacement for #3308 and #3312	28-1/2" H base 12" W x 12" D	20 lbs.	\$100.00
3367	Custom engraved placard - for 3300 series mailbox doors and parcel lockers			\$3.00
3368	Custom engraved door - regular - for 3300 series mailbox doors and parcel lockers			\$3.00
3374	Custom engraved door - black filled - for 3300 series mailbox doors and parcel lockers			\$3.00
3375	Master commercial lock - factory installed if for private access - for access door and parcel lockers - with (2) keys			\$25.00
3390	Lock - standard replacement for 3300 series doors - with (3) keys			\$15.00
3394	Pedestal mounting kit - (4) anchor (j) bolts - for new concrete installations		3 lbs.	\$25.00
3399	Key blanks - for 3300 series locks - box of (50)			\$30.00



¹ Specify

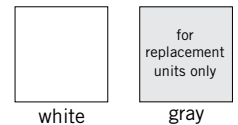
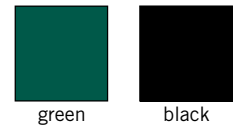
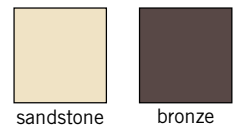

² Specify

- For U.S.P.S. access
- For private access
(order master commercial lock #3375 for access door and parcel locker(s))

OUTGOING MAIL COMPARTMENT
Note: Cluster Box Units (CBU's) include a compartment for outgoing mail collection that is labeled "Outgoing Mail".

Regency® Decorative CBU's - continued on pages 10-11

REGENCY® DECORATIVE CBU'S - FRONT LOADING USPS or PRIVATE access

Made of heavy duty aluminum and stainless steel hardware, Salsbury 3300R series U.S.P.S. approved Regency Decorative Cluster Box Units (CBU's) are available in an easy to order complete package that includes a Salsbury 3300 series CBU and matching pedestal, an attractive decorative CBU top and an elegant decorative CBU pedestal cover. U.S.P.S. approved decorative tops and decorative pedestal covers are made of die-cast aluminum and can be ordered separately - see page 10. The decorative top easily attaches to the CBU and includes a 3" diameter ball finial and an attractive sloping design. The decorative pedestal cover easily attaches over the CBU pedestal and includes installation hardware. Regency Decorative CBU's are accessed from the front through two (2) easy opening master door panels and feature a powder coated finish available in five (5) contemporary colors. Minor assembly is required.



Officially Licensed by the U.S.P.S.

Salsbury 3300 series Cluster Box Units are manufactured to U.S.P.S. "F" specifications. They are an officially licensed product of the U.S. Postal Service for centralized mail delivery.



3308R
Type I

Regency CBU's include:

- CBU
- Pedestal
- CBU Top
- Pedestal Cover



#3312R in bronze finish displayed

SAMPLE INSTALLATION

- Model displayed:
(1) 3312R
Includes:
(1) CBU
(1) Pedestal
(1) CBU Top
(1) Pedestal Cover

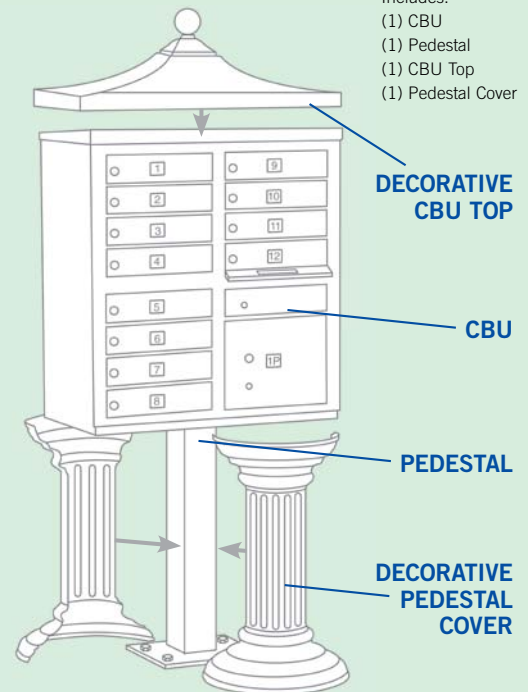

Note: To order Regency Decorative CBU accessories (CBU top and pedestal cover) separately, see page 10.



3312R
Type II



3316R
Type III



3313R
Type IV

REGENCY® DECORATIVE CBU'S – INCLUDES CBU, PEDESTAL, CBU TOP AND PEDESTAL COVER - U.S.P.S. APPROVED

MODEL	DESCRIPTION	UNIT SIZE	WEIGHT	PRICE
REGENCY DECORATIVE CBU'S				
3308R ^{1,2}	Regency Decorative CBU - 8 "A" Size Doors - Type I (8) "A" mail compartments (2) parcel lockers	31" W x 71-3/4" H x 18-1/2" D 12" W x 3" H x 15" D (1) 12" W x 13-1/2" H (1) 12" W x 10" H	190 lbs.	\$1,575.00
3312R ^{1,2}	Regency Decorative CBU - 12 "A" Size Doors - Type II (12) "A" mail compartments (1) parcel locker	31" W x 71-3/4" H x 18-1/2" D 12" W x 3" H x 15" D 12" W x 10" H	190 lbs.	\$1,625.00
3316R ^{1,2}	Regency Decorative CBU - 16 "A" Size Doors - Type III (16) "A" mail compartments (2) parcel lockers	31" W x 71-3/4" H x 18-1/2" D 12" W x 3" H x 15" D (1) 12" W x 13-1/2" H (1) 12" W x 10" H	215 lbs.	\$1,675.00
3313R ^{1,2}	Regency Decorative CBU - 13 "B" Size Doors - Type IV (13) "B" mail compartments (1) parcel locker	31" W x 71-3/4" H x 18-1/2" D 12" W x 4-3/4" H x 15" D 12" W x 10" H	205 lbs.	\$1,650.00

SPARE PARTS / OPTIONS

3351 ¹	Door - "A" replacement door and lock with (3) keys	12-3/4" W x 3-1/8" H		\$40.00
3352 ¹	Door - "B" replacement door and lock with (3) keys	12-3/4" W x 4-7/8" H		\$50.00
3367	Custom engraved placard - for 3300 series mailbox doors and parcel lockers			\$3.00
3368	Custom engraved door - regular - for 3300 series mailbox doors and parcel lockers			\$3.00
3374	Custom engraved door - black filled - for 3300 series mailbox doors and parcel lockers			\$3.00
3375	Master commercial lock - factory installed if for private access - for access door and parcel lockers - with (2) keys			\$25.00
3390	Lock - standard replacement for 3300 series doors - with (3) keys			\$15.00
3394	Pedestal mounting kit - (4) anchor (j) bolts - for new concrete installations		3 lbs.	\$25.00
3399	Key blanks - for 3300 series locks - box of (50)			\$30.00



¹ Specify



white

² Specify

- For U.S.P.S. access
- For private access
(order master commercial lock #3375 for access door and parcel lockers)



OUTGOING MAIL COMPARTMENT
Note: Regency Decorative CBU's include a compartment for outgoing mail collection that is labeled "Outgoing Mail".

CBU Specifications & Options - for CBU's and Regency CBU's on pages 6-9



#3316 in sandstone finish with black filled custom engraved doors (#3374) displayed

- Ideal for Residential and Commercial Developments
- Manufactured by Salsbury Industries to U.S.P.S. "F" Specifications
- All Aluminum Construction
- Matching Pedestal Included
- Heavy Duty Cam Locks
- Outgoing Mail Compartment
- Fully Integrated Parcel Locker(s)
- Matching Stand-Alone Outdoor Parcel Lockers (OPL's) (#3302) Available (see page 60)



REGENCY® DECORATIVE CBU ACCESSORIES U.S.P.S. APPROVED

Made of die cast aluminum, Salsbury U.S.P.S. approved Regency Decorative CBU accessories can be ordered separately from Salsbury 3300 series CBU's. Decorative CBU accessories feature a durable powder coated finish available in five (5) contemporary colors and provide an elegant finished look to CBU installations. Decorative CBU tops (#3350) include a 3" diameter ball finial and an attractive sloping design and easily mount to the top of CBU's with four (4) set screws (provided). Decorative CBU pedestal covers (short - #3386 and tall - #3396) easily attach over CBU pedestals and include a plastic insect guard and installation hardware.



- 3350¹ Regency CBU Top**
(option for CBU #3308, #3312, #3316 and #3313)
- 31" W x 11-1/2" H x 18-1/2" D
 - 20 lbs.
 - \$275.00



- 3386¹ Regency Pedestal Cover - Short**
(option for pedestal for CBU #3316 and CBU #3313)
- 13-3/4" H x 17-3/4" diameter
 - 20 lbs.
 - \$275.00



- 3396¹ Regency Pedestal Cover - Tall**
(option for pedestal for CBU #3308 and CBU #3312)
- 27-3/4" H x 17-3/4" diameter
 - 25 lbs.
 - \$275.00

¹ Specify



sandstone



bronze

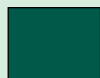

green



black



white

(not available in gray)

SAMPLE INSTALLATION OF CBU ACCESSORIES

Models displayed:
(1) 3350 CBU Top
(1) 3312 CBU (includes pedestal)
(1) 3396 Pedestal Cover - Tall

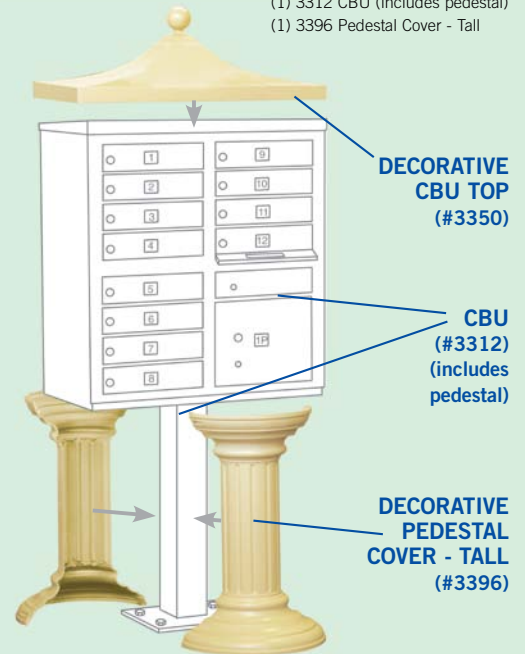

Note: Regency decorative tops and pedestal covers are available in a complete package that includes the CBU and pedestal (see pages 8-9).

STANDARD FEATURES

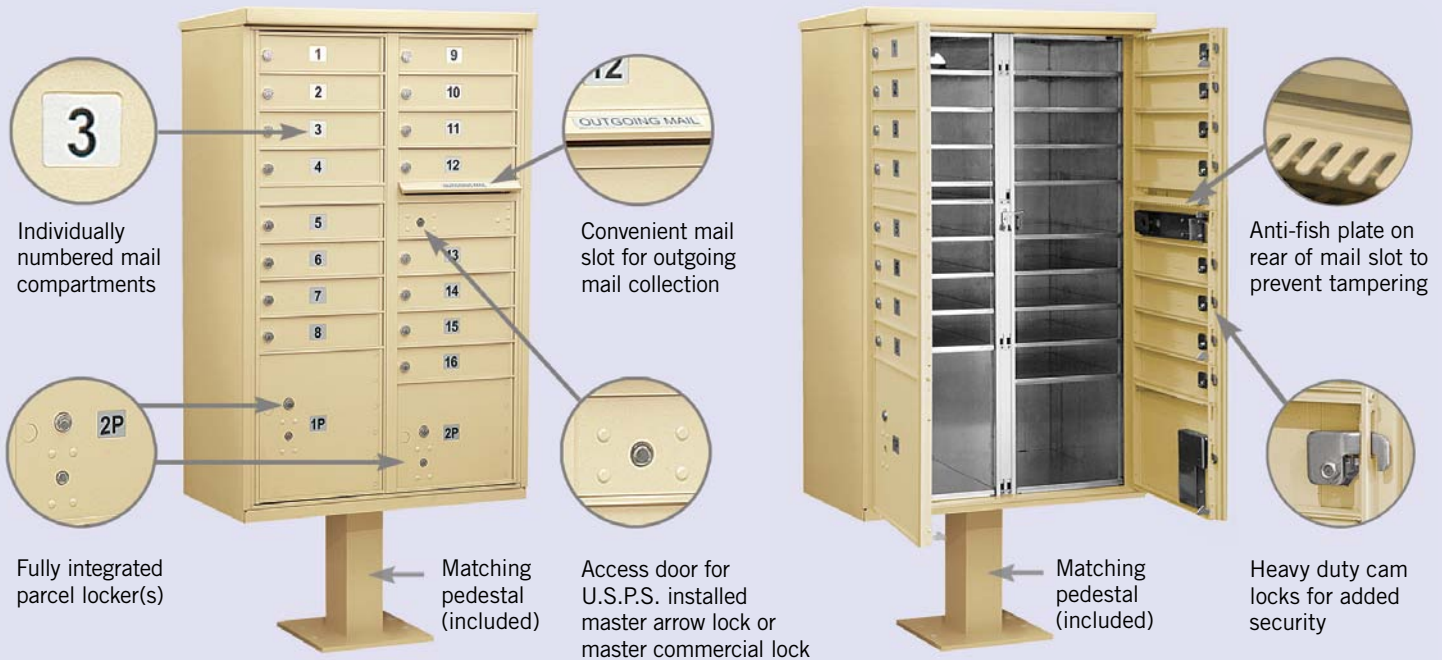

Front views of 3316 in sandstone finish displayed

CBU SPECIFICATIONS & OPTIONS

MAILBOX DOOR SIZES

Each aluminum mailbox door includes a heavy duty five (5) pin cylinder cam lock with a dust/rain shield and three (3) keys.

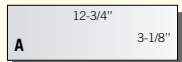

#3351 ¹ Replacement "A" door and lock \$40.00

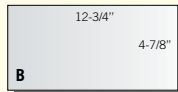

#3352 ¹ Replacement "B" door and lock \$50.00

PARCEL LOCKER DOOR SIZES

Each CBU includes one or two (2) fully integrated parcel lockers. Parcel lockers offer tenants a convenient way to receive packages on site and are fit with a two (2) key security system.

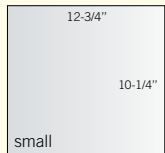

#3353 ¹ Replacement parcel locker door and tenant lock - small \$70.00

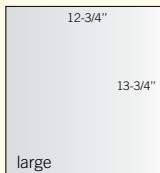

#3354 ¹ Replacement parcel locker door and tenant lock - large \$80.00

PEDESTALS

#3385 ¹ Replacement pedestal for #3316 and #3313 (14-1/2" H) \$100.00

#3395 ¹ Replacement pedestal for #3308 and #3312 (28-1/2" H) \$100.00

#3394 Pedestal mounting kit (4) 1/2" X 12" anchor (j) bolts \$25.00

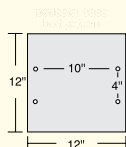

FINISHES

Durable and corrosion resistant CBU's feature a powder coated finish available in sandstone, bronze, green, black or white. Note - gray is available for replacement units only and is not available on Regency Decorative CBU's and accessories.

¹ Specify



sandstone



bronze



green



black

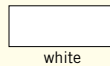

white

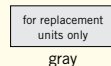

gray

IDENTIFICATION SYSTEMS

Each CBU mailbox door has a 1" high number (1-8, 1-12, 1-16, 1-13 for Type I, Type II, Type III and Type IV, respectively). The outgoing mail compartment is labeled "Outgoing Mail" and the parcel locker(s) are labeled with a "1P" on #3312 and #3313 and with a "1P" and a "2P" on #3308 and #3316. Custom identification systems are available as an option upon request.

CUSTOM ENGRAVED DOOR PLACARDS

1-3/4" W x 1-1/2" H custom engraved self-adhesive door placards are available as an option upon request. (#3367 - \$3.00)



#3367

CUSTOM ENGRAVED UNIT PLACARDS

8" W x 1" H custom engraved self-adhesive unit placards are available as an option upon request. (#3363 - \$15.00)



#3363

LOCKS

Each CBU mailbox door includes a heavy duty five (5) pin cylinder cam lock with a dust/rain shield and three (3) keys (2,000 different key changes). (#3390 - \$15.00)

- Additional keys per lock when ordering (#3398 - \$2.00)
- Key blanks - box of (50) (#3399 - \$30.00)

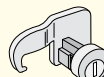

#3390

CUSTOM ENGRAVED DOORS

- Custom engraved door - regular (#3368 - \$3.00)
- Custom engraved door - black filled (#3374 - \$3.00)



#3368



#3374

OUTGOING MAIL COMPARTMENTS

One additional compartment in each CBU is labeled "Outgoing Mail" and includes a weather protection flap and an 11-3/4" W x 3/4" H mail slot.

OUTGOING MAIL SLOT PLUG KIT

An outgoing mail slot plug kit is available for installations not serviced by the U.S.P.S. (#3370 - \$35.00)

MASTER COMMERCIAL LOCK

Factory installed if for private access - for access door and parcel lockers - with (2) keys (#3375 - \$25.00)

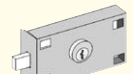

#3375

TENANT PARCEL LOCKER LOCK

For parcel locker door - with (3) keys (#3376 - \$35.00)

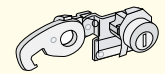

#3376

Note: For E series replacement CBU locks, see 3390-E on page 62.

4C Standard Horizontal Mailboxes - continued on pages 14-19

4C STANDARD HORIZONTAL MAILBOXES FRONT OR REAR LOADING

Made of heavy duty aluminum and stainless steel hardware, Salsbury 3700 series 4C standard horizontal mailboxes and parcel lockers are U.S.P.S. approved and are available with standard MB1 mailbox doors (13-1/4" W x 3-1/4" H) and larger MB2 and MB3 mailbox doors – see door sizes on page 19. All mailbox doors include a heavy duty cam lock with a dust/rain shield and three (3) keys. 4C standard horizontal mailbox units include factory installed 3/4" W x 1/4" D trim and are available in configurations that are one door wide (single column) and two (2) doors wide (double column). The Salsbury maximum height 3716D-20 units have two (2) fully integrated 15-1/2" high parcel lockers and twenty (20) standard MB1 mailbox doors and meet the U.S.P.S. 4C requirement of a minimum of one parcel locker for every ten (10) tenant compartments. Many other standard units in three (3) to fifteen (15) equivalent standard MB1 mailbox door heights are also available. Fully integrated and stand-alone parcel lockers are available in five (5) equivalent standard MB1 mailbox door heights (PL5 – 17-1/4" high) and six (6) equivalent standard MB1 mailbox door heights (PL6 – 20-3/4" high). A compartment equivalent to two (2) standard MB1 mailbox door heights is used for outgoing mail collection and is labeled "Outgoing Mail". The outgoing mail compartment includes a weather protection hood and a 10-3/4" W x 3/4" H mail slot. Designed for indoor or outdoor use, 4C standard horizontal mailboxes feature a durable powder coated finish available in four (4) contemporary colors.

ALL ALUMINUM CONSTRUCTION

#3716D-20
maximum height
4C standard horizontal
mailboxes in aluminum finish with
custom engraved placards (#3767) displayed

4C STANDARD HORIZONTAL MAILBOXES - FRONT OR REAR LOADING - U.S.P.S. APPROVED

MODEL	DESCRIPTION	UNIT SIZE - FL and RL (includes trim)	WEIGHT	PRICE
MAXIMUM HEIGHT UNITS - 56-3/4" H (maximum allowable height)				
3716D-20 ^{1,2,3}	20 MB1 Doors and 2 Parcel Lockers (15-1/2" H)	31-1/8" W x 56-3/4" H x 17" D	170 lbs.	\$1,375.00
3716S-09 ^{1,2,3}	9 MB1 Doors and one Parcel Locker (15-1/2" H)	16-3/8" W x 56-3/4" H x 17" D	85 lbs.	\$675.00
3716D-09 ^{1,2,3}	7 MB2 Doors, 2 MB3 Doors, 2 Parcel Lockers (15-1/2" H)	31-1/8" W x 56-3/4" H x 17" D	160 lbs.	\$1,100.00
15 DOOR HIGH UNITS - 55" H (equivalent to 15 standard mailbox doors (MB1) high)				
3715D-18 ^{1,2,3}	18 MB1 Doors and 2 Parcel Lockers (PL5)	31-1/8" W x 55" H x 17" D	160 lbs.	\$1,275.00
3715D-16 ^{1,2,3}	16 MB1 Doors and 2 Parcel Lockers (PL6)	31-1/8" W x 55" H x 17" D	160 lbs.	\$1,225.00
3715S-08 ^{1,2,3}	8 MB1 Doors and one Parcel Locker (PL5)	16-3/8" W x 55" H x 17" D	80 lbs.	\$625.00
3715S-07 ^{1,2,3}	7 MB1 Doors and one Parcel Locker (PL6)	16-3/8" W x 55" H x 17" D	80 lbs.	\$600.00
3715D-09 ^{1,2,3}	9 MB2 Doors and 2 Parcel Lockers (PL5)	31-1/8" W x 55" H x 17" D	150 lbs.	\$1,050.00
14 DOOR HIGH UNITS - 51-1/2" H (equivalent to 14 standard mailbox doors (MB1) high)				
3714D-16 ^{1,2,3}	16 MB1 Doors and 2 Parcel Lockers (PL5)	31-1/8" W x 51-1/2" H x 17" D	155 lbs.	\$1,175.00
3714D-15 ^{1,2,3}	15 MB1 Doors and 2 Parcel Lockers (PL5, PL6)	31-1/8" W x 51-1/2" H x 17" D	155 lbs.	\$1,150.00
3714S-03 ^{1,2,3}	3 MB2 Doors and one Parcel Locker (PL6)	16-3/8" W x 51-1/2" H x 17" D	75 lbs.	\$475.00
3714S-2P ^{1,2,3}	Stand-alone Parcel Lockers 2 (PL6)	16-3/8" W x 51-1/2" H x 17" D	75 lbs.	\$425.00
3714D-07 ^{1,2,3}	7 MB2 Doors and 2 Parcel Lockers (PL6)	31-1/8" W x 51-1/2" H x 17" D	145 lbs.	\$950.00
13 DOOR HIGH UNITS - 48" H (equivalent to 13 standard mailbox doors (MB1) high)				
3713D-14 ^{1,2,3}	14 MB1 Doors and 2 Parcel Lockers (PL5)	31-1/8" W x 48" H x 17" D	150 lbs.	\$1,075.00
3713D-13 ^{1,2,3}	13 MB1 Doors and 2 Parcel Lockers (PL5, PL6)	31-1/8" W x 48" H x 17" D	150 lbs.	\$1,050.00
3713S-06 ^{1,2,3}	6 MB1 Doors and one Parcel Locker (PL5)	16-3/8" W x 48" H x 17" D	75 lbs.	\$525.00
3713S-05 ^{1,2,3}	5 MB1 Doors and one Parcel Locker (PL6)	16-3/8" W x 48" H x 17" D	75 lbs.	\$500.00
3713D-07 ^{1,2,3}	7 MB2 Doors and 2 Parcel Lockers (PL5)	31-1/8" W x 48" H x 17" D	140 lbs.	\$900.00

MAXIMUM HEIGHT UNITS - 56-3/4" H



3716D-20

Our most popular model #3716D-20 meets the U.S.P.S. 4C requirement of a minimum of one parcel locker for every ten (10) tenant compartments.

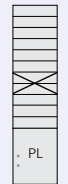

3716S-09

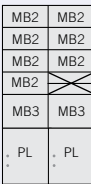

3716D-09

15 DOOR HIGH UNITS - 55" H



3715D-18



3715D-16

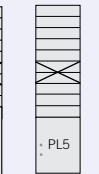

3715S-08



3715S-07

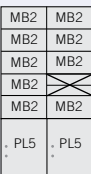

3715D-09

14 DOOR HIGH UNITS - 51-1/2" H

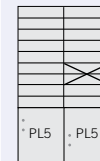

3714D-16

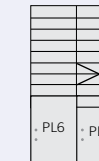

3714D-15

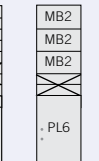

3714S-03

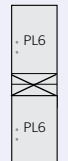

3714S-2P

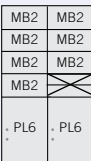

3714D-07

13 DOOR HIGH UNITS - 48" H

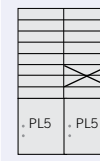

3713D-14

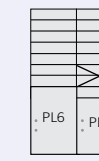

3713D-13

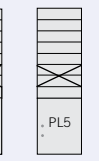

3713S-06



3713S-05

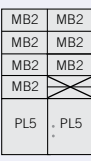

3713D-07



Note: 3700 series 4C standard horizontal mailboxes and parcel lockers have been U.S.P.S. approved and meet the specifications of USPS-STD-4C. These units are required for new construction and major renovations.



3716D-20
Front Loading - 20 MB1 Doors
and 2 Parcel Lockers



3716S-09
Front Loading - 9 MB1 Doors
and one Parcel Locker



3716D-09
Front Loading - 7 MB2 Doors,
2 MB3 Doors and 2 Parcel Lockers

4C STANDARD HORIZONTAL MAILBOXES - FRONT OR REAR LOADING - U.S.P.S. APPROVED

MODEL	DESCRIPTION	UNIT SIZE - FL and RL (includes trim)	WEIGHT	PRICE
12 DOOR HIGH UNITS - 44-1/2" H (equivalent to 12 standard mailbox doors (MB1) high)				
3712D-12 ^{1,2,3}	12 MB1 Doors and 2 Parcel Lockers (PL5)	31-1/8" W x 44-1/2" H x 17" D	145 lbs.	\$975.00
3712D-11 ^{1,2,3}	11 MB1 Doors and 2 Parcel Lockers (PL5, PL6)	31-1/8" W x 44-1/2" H x 17" D	145 lbs.	\$950.00
3712S-02 ^{1,2,3}	2 MB2 Doors and one Parcel Locker (PL6)	16-3/8" W x 44-1/2" H x 17" D	70 lbs.	\$400.00
3712S-2P ^{1,2,3}	Stand-alone Parcel Lockers 2 (PL6)	16-3/8" W x 44-1/2" H x 17" D	70 lbs.	\$350.00
11 DOOR HIGH UNITS - 41" H (equivalent to 11 standard mailbox doors (MB1) high)				
3711D-20 ^{1,2,3}	20 MB1 Doors - no Parcel Lockers	31-1/8" W x 41" H x 17" D	145 lbs.	\$1,075.00
3711D-09 ^{1,2,3}	9 MB1 Doors and 2 Parcel Lockers (PL5, PL6)	31-1/8" W x 41" H x 17" D	130 lbs.	\$850.00
3711S-09 ^{1,2,3}	9 MB1 Doors - no Parcel Lockers	16-3/8" W x 41" H x 17" D	75 lbs.	\$525.00
3711S-2P ^{1,2,3}	Stand-alone Parcel Lockers (PL5, PL6)	16-3/8" W x 41" H x 17" D	65 lbs.	\$325.00
10 DOOR HIGH UNITS - 37-1/2" H (equivalent to 10 standard mailbox doors (MB1) high)				
3710D-18 ^{1,2,3}	18 MB1 Doors - no Parcel Lockers	31-1/8" W x 37-1/2" H x 17" D	135 lbs.	\$975.00
3710D-08 ^{1,2,3}	8 MB1 Doors and 2 Parcel Lockers (PL5)	31-1/8" W x 37-1/2" H x 17" D	125 lbs.	\$775.00
3710S-08 ^{1,2,3}	8 MB1 Doors - no Parcel Lockers	16-3/8" W x 37-1/2" H x 17" D	75 lbs.	\$475.00
3710S-2P ^{1,2,3}	Stand-alone Parcel Lockers 2 (PL5)	16-3/8" W x 37-1/2" H x 17" D	65 lbs.	\$300.00
9 DOOR HIGH UNITS - 34" H (equivalent to 9 standard mailbox doors (MB1) high)				
3709D-16 ^{1,2,3}	16 MB1 Doors - no Parcel Lockers	31-1/8" W x 34" H x 17" D	125 lbs.	\$875.00
3709D-10 ^{1,2,3}	10 MB1 Doors and one Parcel Locker (PL6)	31-1/8" W x 34" H x 17" D	115 lbs.	\$750.00
3709S-07 ^{1,2,3}	7 MB1 Doors - no Parcel Lockers	16-3/8" W x 34" H x 17" D	70 lbs.	\$425.00
3709S-02 ^{1,2,3}	2 MB1 Doors and one Parcel Locker (PL5)	16-3/8" W x 34" H x 17" D	60 lbs.	\$325.00



² Specify - front loading (FL) or rear loading (RL)

³ Specify - U.S.P.S. access or private access (order #3775 master commercial lock for private access on FL units and PL's)

12 DOOR HIGH UNITS - 44-1/2" H

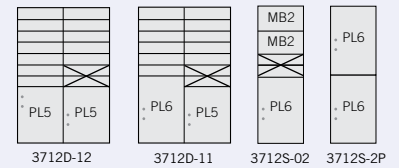

11 DOOR HIGH UNITS - 41" H

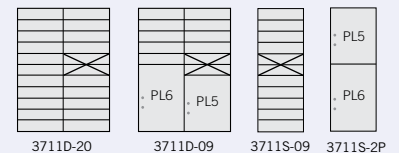

10 DOOR HIGH UNITS - 37-1/2" H

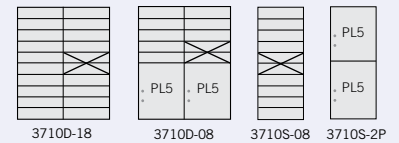

9 DOOR HIGH UNITS - 34" H

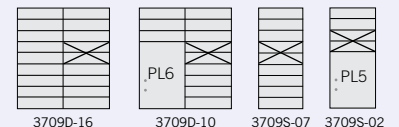

COMMERCIAL MAILBOXES

RESIDENTIAL MAILBOXES

CUSTOM SIGNAGE

CELL PHONE LOCKERS

*more
4C standard
mailboxes available on
pages 14-15 and on-line*

4C Standard Horizontal Mailboxes - continued on pages 16-19



#3716D-20 maximum height
4C standard horizontal mailboxes in bronze finish
with custom engraved doors - regular (#3768) displayed

- Manufactured by Salsbury Industries to USPS-STD-4C Specifications
- Required for New Construction
- ADA Compliance Guidelines 
- For Indoor or Outdoor Use
- Fully Integrated or Stand-Alone Parcel Lockers

Note: U.S.P.S. standard 4C requires a minimum of one parcel locker for every ten (10) tenant compartments. Parcel lockers are not required for installation sites with less than ten (10) tenant compartments.

4C STANDARD HORIZONTAL MAILBOXES - FRONT OR REAR LOADING - U.S.P.S. APPROVED

MODEL	DESCRIPTION	UNIT SIZE - FL and RL (includes trim)	WEIGHT	PRICE
8 DOOR HIGH UNITS - 30-1/2" H (equivalent to 8 standard mailbox doors (MB1) high)				
3708D-14 ^{1,2,3}	14 MB1 Doors - no Parcel Lockers	31-1/8" W x 30-1/2" H x 17" D	115 lbs.	\$775.00
3708D-09 ^{1,2,3}	9 MB1 Doors and one Parcel Locker (PL5)	31-1/8" W x 30-1/2" H x 17" D	95 lbs.	\$675.00
3708S-06 ^{1,2,3}	6 MB1 Doors - no Parcel Lockers	16-3/8" W x 30-1/2" H x 17" D	65 lbs.	\$375.00
3708S-01 ^{1,2,3}	1 MB1 Door and one Parcel Locker (PL5)	16-3/8" W x 30-1/2" H x 17" D	65 lbs.	\$275.00
3708D-04 ^{1,2,3}	4 MB2 Doors and one Parcel Locker (PL6)	31-1/8" W x 30-1/2" H x 17" D	95 lbs.	\$550.00
7 DOOR HIGH UNITS - 27" H (equivalent to 7 standard mailbox doors (MB1) high)				
3707D-12 ^{1,2,3}	12 MB1 Doors - no Parcel Lockers	31-1/8" W x 27" H x 17" D	100 lbs.	\$675.00
3707D-06 ^{1,2,3}	6 MB1 Doors and one Parcel Locker (PL6)	31-1/8" W x 27" H x 17" D	90 lbs.	\$550.00
3707S-05 ^{1,2,3}	5 MB1 Doors - no Parcel Lockers	16-3/8" W x 27" H x 17" D	55 lbs.	\$325.00
3707S-1P ^{1,2,3}	Stand-alone Parcel Locker (PL5)	16-3/8" W x 27" H x 17" D	50 lbs.	\$225.00
3707D-03 ^{1,2,3}	2 MB2 Doors, 1 MB3 Door, one Parcel Locker (PL5)	31-1/8" W x 27" H x 17" D	90 lbs.	\$475.00
6 DOOR HIGH UNITS - 23-1/2" H (equivalent to 6 standard mailbox doors (MB1) high)				
3706D-10 ^{1,2,3}	10 MB1 Doors - no Parcel Lockers	31-1/8" W x 23-1/2" H x 17" D	90 lbs.	\$575.00
3706D-04 ^{1,2,3}	4 MB1 Doors and one Parcel Locker (PL6)	31-1/8" W x 23-1/2" H x 17" D	80 lbs.	\$450.00
3706S-04 ^{1,2,3}	4 MB1 Doors - no Parcel Lockers	16-3/8" W x 23-1/2" H x 17" D	50 lbs.	\$275.00
3706S-1P ^{1,2,3}	Stand-alone Parcel Locker (PL6)	16-3/8" W x 23-1/2" H x 17" D	45 lbs.	\$175.00
3706D-02 ^{1,2,3}	2 MB2 Doors and one Parcel Locker (PL6)	31-1/8" W x 23-1/2" H x 17" D	80 lbs.	\$400.00
5 DOOR HIGH UNITS - 20" H (equivalent to 5 standard mailbox doors (MB1) high)				
3705D-08 ^{1,2,3}	8 MB1 Doors - no Parcel Lockers	31-1/8" W x 20" H x 17" D	75 lbs.	\$475.00
3705D-03 ^{1,2,3}	3 MB1 Doors and one Parcel Locker (PL5)	31-1/8" W x 20" H x 17" D	65 lbs.	\$375.00
3705S-03 ^{1,2,3}	3 MB1 Doors - no Parcel Lockers	16-3/8" W x 20" H x 17" D	40 lbs.	\$225.00
3705S-1P ^{1,2,3}	Stand-alone Parcel Locker (PL5)	16-3/8" W x 20" H x 17" D	30 lbs.	\$150.00
3705D-01 ^{1,2,3}	1 MB3 Door and one Parcel Locker (PL5)	31-1/8" W x 20" H x 17" D	45 lbs.	\$325.00

8 DOOR HIGH UNITS - 30-1/2" H



7 DOOR HIGH UNITS - 27" H



6 DOOR HIGH UNITS - 23-1/2" H



5 DOOR HIGH UNITS - 20" H





Note: 3700 series 4C standard horizontal mailboxes and parcel lockers have been U.S.P.S. approved and meet the specifications of USPS-STD-4C. These units are required for new construction and major renovations.

4C CONFIGURATOR

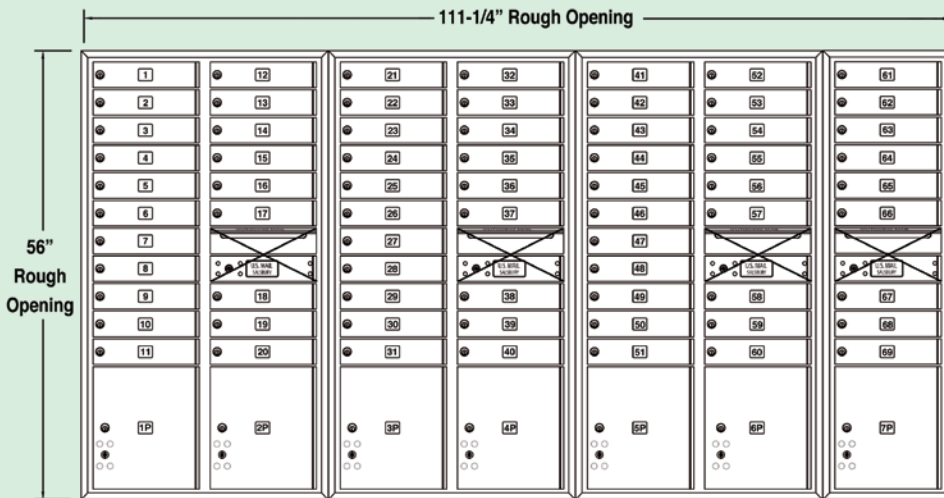

- Line drawings with specific dimensions
- ADA layouts available
- Options for larger doors and parcel lockers
- Options for sequential and custom engraving

4C Configurator Available On-line

Our 4C configurator will help you determine the optimal number of mailboxes and parcel lockers based on your specific requirements. A clear and easy to read line drawing with rough opening dimensions will be provided.

4C STANDARD HORIZONTAL MAILBOXES - FRONT OR REAR LOADING - U.S.P.S. APPROVED

MODEL	DESCRIPTION	UNIT SIZE - FL and RL (includes trim)	WEIGHT	PRICE
4 DOOR HIGH UNITS - 16-1/2" H (equivalent to 4 standard mailbox doors (MB1) high)				
3704D-06 ^{1,2,3}	6 MB1 Doors - no Parcel Lockers	31-1/8" W x 16-1/2" H x 17" D	65 lbs.	\$375.00
3704S-02 ^{1,2,3}	2 MB1 Doors - no Parcel Lockers	16-3/8" W x 16-1/2" H x 17" D	35 lbs.	\$175.00
3704S-01 ^{1,2,3}	1 MB2 Door - no Parcel Lockers	16-3/8" W x 16-1/2" H x 17" D	35 lbs.	\$150.00
3 DOOR HIGH UNITS - 13" H (equivalent to 3 standard mailbox doors (MB1) high)				
3703D-04 ^{1,2,3}	4 MB1 Doors - no Parcel Lockers	31-1/8" W x 13" H x 17" D	50 lbs.	\$275.00
3703S-01 ^{1,2,3}	1 MB1 Door - no Parcel Lockers	16-3/8" W x 13" H x 17" D	30 lbs.	\$125.00

SPARE PARTS / OPTIONS

3751 ¹	Door - MB1 replacement door and lock with (3) keys	13-1/4" W x 3-1/4" H	1 lbs.	\$40.00
3752 ¹	Door - MB2 replacement door and lock with (3) keys	13-1/4" W x 6-3/4" H	2 lbs.	\$50.00
3753 ¹	Door - MB3 replacement door and lock with (3) keys	13-1/4" W x 10-1/4" H	2 lbs.	\$60.00
3754 ¹	Door - MB4 replacement door and lock with (3) keys	13-1/4" W x 13-3/4" H	3 lbs.	\$70.00
3767	Custom engraved placard - for 3700 series mailbox doors and parcel lockers			\$3.00
3768	Custom engraved door - regular - for 3700 series mailbox doors and parcel lockers			\$3.00
3774	Custom engraved door - black filled - for 3700 series mailbox doors and parcel lockers			\$3.00
3775	Master commercial lock - factory installed if for private access - for FL mailboxes and PL's - with (2) keys			\$25.00
3776	Tenant parcel locker lock - with (3) keys			\$35.00
3790	Lock - standard replacement for 3700 series mailbox door - with (3) keys			\$15.00
3799	Key blanks - for standard 3700 series locks - box of (50)			\$30.00

¹ Specify

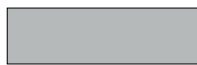

aluminum

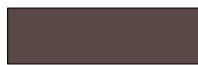

bronze



gold

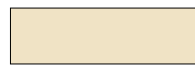

sandstone

² Specify - front loading (FL) or rear loading (RL)

³ Specify - U.S.P.S. access or private access (order #3775 master commercial lock for private access on FL units and PL's)

4 DOOR HIGH UNITS - 16-1/2" H



3 DOOR HIGH UNITS - 13" H



OUTGOING MAIL COMPARTMENT (OM2)

Note: Both front loading and rear loading mailbox units include a two (2) door high compartment for outgoing mail collection that is labeled "Outgoing Mail". Front loading units also include an access door along with the outgoing mail collection compartment.

Surface Mounted and Free-Standing Enclosures for 4C Horizontal Mailboxes are available - see pages 20-23



4C Custom Horizontal Mailboxes - continued on pages 18-19



4C custom horizontal mailboxes in gold finish with optional custom engraved doors - black filled (#3774) displayed

4C CUSTOM HORIZONTAL MAILBOXES FRONT OR REAR LOADING



Made of heavy duty aluminum and stainless steel hardware, Salsbury 3700 series 4C custom horizontal mailboxes and parcel lockers are U.S.P.S. approved and are available in configurations that are one door wide (single column) and two (2) doors wide (double column). Units include factory installed 3/4" W x 1/4" D trim and can be configured with a combination of four (4) mailbox door sizes and two (2) parcel locker door sizes to meet your custom requirements (please submit required layout). A compartment equivalent to two (2) 3-1/4" high standard MB1 doors must be reserved in each custom front loading mailbox unit for outgoing mail collection and the access door. 4C custom horizontal mailboxes feature a durable powder coated finish available in four (4) contemporary colors. Custom colors are available as an option upon request. 4C custom horizontal mailboxes are designed for indoor or outdoor use and are ideal for apartments, residential communities, commercial buildings and many other applications.

PARCEL LOCKERS can be fully integrated into the 3700 series 4C custom horizontal mailbox units. A minimum of one parcel locker is required for every ten (10) tenant compartments. Parcel lockers are not required for installation sites with less than ten (10) tenant compartments.

ORDERING A 4C CUSTOM HORIZONTAL UNIT

Following simple guidelines, custom units can be configured with a combination of varying sizes of mailbox doors and parcel locker doors.

Custom units can accommodate mailbox doors from 1 high (3-1/4") to 4 high (13-3/4") and parcel locker doors either 5 high (17-1/4") or 6 high (20-3/4"). Custom units are available for both front or rear loading applications.

Custom units are available in equivalent standard MB1 mailbox door heights of three (3) to fifteen (15) - see Note 2 at bottom right. The outgoing mail compartment / carrier access door (OM2) must be situated in the designated position. See the diagrams of our standard units on pages 12-15 for illustrations of the designated position of the outgoing mail compartment / access door (OM2) in their respective heights.

Single or double column units can be configured from a minimum of three (3) standard one high mailbox doors (MB1) to a maximum of fifteen (15) standard one high mailbox doors (MB1) including both mailboxes and parcel lockers. Mailboxes are only permitted in the top eleven (11) one high mailbox door (MB1) positions. Parcel lockers may be positioned anywhere. U.S.P.S. standard 4C requires a minimum of one parcel locker for every ten (10) tenant compartments. Parcel lockers are not required for installation sites with less than ten (10) tenant compartments.

- Determine the number of openings required using MB1, MB2, MB3 and MB4 mailbox doors and PL5 and PL6 parcel locker doors.

DOOR SIZES:
 MB1 - 13-1/4" W x 3-1/4" H
 MB2 - 13-1/4" W x 6-3/4" H
 MB3 - 13-1/4" W x 10-1/4" H
 MB4 - 13-1/4" W x 13-3/4" H

PL5 - 13-1/4" W x 17-1/4" H
 PL6 - 13-1/4" W x 20-3/4" H

- Configure your requirements into a single or double column unit and into equivalent standard mailbox door heights of three (3) to fifteen (15). Specify front or rear loading. The outgoing mail compartment / access door (OM2) must be situated in the designated position. See the diagrams of our standard units on pages 12-15 for illustrations of the designated position of the outgoing mail compartment / access door (OM2) in their respective heights.

- Contact us for rough opening dimensions and layout specifications.

**Submit Required
Layout and Options
for a Price Quotation!**

SAMPLE DOUBLE COLUMN FRONT LOADING UNIT

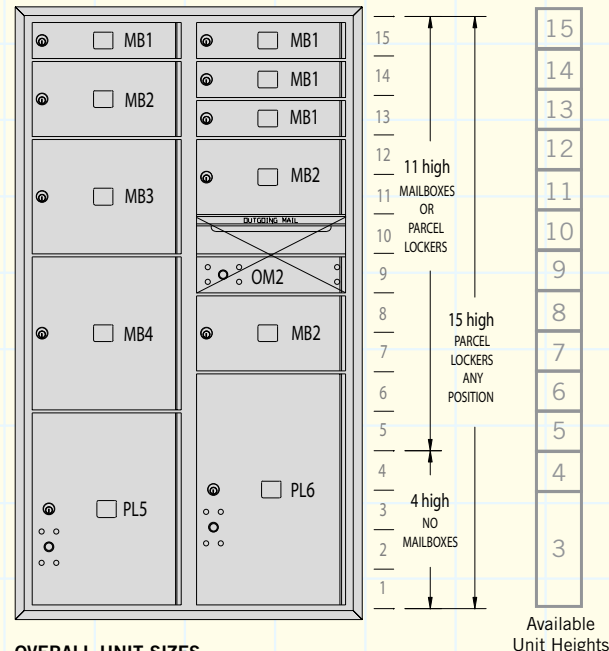

OVERALL UNIT SIZES

Overall unit sizes are summarized on pages 12-15. Match the configuration you require to the standard unit height.

- Note 1: MB1 is the smallest mailbox door available. MB4 is the largest mailbox door available. PL5 is the smallest parcel locker door available. PL6 is the largest parcel locker door available.

Note 2: We can customize the maximum height units (56-3/4" high) - see pages 12-15. Please contact our design engineers for layout, options and pricing.



Note: 3700 series 4C custom horizontal mailboxes and parcel lockers have been U.S.P.S. approved and meet the specifications of USPS-STD-4C. These units are required for new construction and major renovations.



Custom rear loading
single column unit displayed



Custom front loading
double column unit displayed

DESIGN ASSISTANCE

Our design engineers are available to architects, specification writers and individuals involved in the design of mail distribution facilities, apartment complexes and commercial buildings. You can also submit required layout and options for a price quotation!

- Surface mounted and free-standing enclosures for 4C standard and custom horizontal mailboxes are available – see pages 20-23
- 4C standard and custom horizontal mailboxes can be mounted on pedestals – see pages 24-27

4C CUSTOM HORIZONTAL MAILBOXES - FRONT OR REAR LOADING - U.S.P.S. APPROVED

MODEL	DESCRIPTION	DOOR SIZE	WEIGHT	PRICE
MAILBOXES				
3700MB1 ^{1,2,3}	MB1 Door and 17" D Compartment	13-1/4" W x 3-1/4" H	5 lbs.	\$55.00
3700MB2 ^{1,2,3}	MB2 Door and 17" D Compartment	13-1/4" W x 6-3/4" H	10 lbs.	\$80.00
3700MB3 ^{1,2,3}	MB3 Door and 17" D Compartment	13-1/4" W x 10-1/4" H	15 lbs.	\$105.00
3700MB4 ^{1,2,3}	MB4 Door and 17" D Compartment	13-1/4" W x 13-3/4" H	20 lbs.	\$130.00
3700OM2 ^{1,2,3}	OM2 Outgoing Mail Compartment / Access Door*	13-1/4" W x 6-3/4" H	10 lbs.	\$80.00
PARCEL LOCKERS				
3700PL5 ^{1,2,3}	PL5 Parcel Locker and 17" D Compartment	13-1/4" W x 17-1/4" H	25 lbs.	\$175.00
3700PL6 ^{1,2,3}	PL6 Parcel Locker and 17" D Compartment	13-1/4" W x 20-3/4" H	30 lbs.	\$200.00
SPARE PARTS / OPTIONS				
3751 ¹	Door - MB1 replacement door and lock with (3) keys	13-1/4" W x 3-1/4" H	1 lb.	\$40.00
3752 ¹	Door - MB2 replacement door and lock with (3) keys	13-1/4" W x 6-3/4" H	2 lbs.	\$50.00
3753 ¹	Door - MB3 replacement door and lock with (3) keys	13-1/4" W x 10-1/4" H	2 lbs.	\$60.00
3754 ¹	Door - MB4 replacement door and lock with (3) keys	13-1/4" W x 13-3/4" H	3 lbs.	\$70.00
3766	Custom finish - specify color			add 10%
3767	Custom engraved placard - for 3700 series mailbox doors and parcel lockers			\$3.00
3768	Custom engraved door - regular - for 3700 series mailbox doors and parcel lockers			\$3.00
3774	Custom engraved door - black filled - for 3700 series mailbox doors and parcel lockers			\$3.00
3775	Master commercial lock - factory installed if for private access - for FL mailboxes and PL's - with (2) keys			\$25.00
3776	Tenant parcel locker lock - with (3) keys			\$35.00
3790	Lock - standard replacement for 3700 series mailbox door - with (3) keys			\$15.00
3799	Key blanks - for standard 3700 series locks - box of (50)			\$30.00

¹ Specify



aluminum



bronze



gold

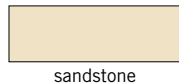

sandstone

² Specify - front loading (FL) or rear loading (RL)

³ Specify - U.S.P.S. access or private access (order #3775 master commercial lock for private access on FL units and PL's)

* The Outgoing Mail Compartment / Access Door (OM2) must be situated in the designated position. See the diagrams of our standard units on pages 12-15.

Note: The price of 4C custom horizontal mailboxes is the total of each mailbox door and compartment, parcel locker and outgoing mail compartment within a unit. Allow approximately 2-3 weeks production time for 4C custom horizontal mailboxes. For faster service, see pages 12-15 for 4C standard horizontal mailboxes.

4C Horizontal Mailbox Specifications & Options



- Manufactured by Salsbury Industries to USPS-STD-4C Specifications
- Required for New Construction
- ADA Compliance Guidelines 
- For Indoor or Outdoor Use
- Fully Integrated or Stand-Alone Parcel Lockers

ALL ALUMINUM CONSTRUCTION

#3716D-20 maximum height 4C standard horizontal mailboxes in bronze finish with custom engraved placards (#3767) displayed

Note: U.S.P.S. standard 4C requires a minimum of one parcel locker for every ten (10) tenant compartments. Parcel lockers are not required for installation sites with less than ten (10) tenant compartments.

If Rear Loading: The front of the two (2) high outgoing mail compartment is comprised of two (2) fixed panels (no access door). The rear of the unit incorporates one or two (2) access door(s) with heavy duty latches and continuous hinges. Units available without rear access doors upon request.



3716D-20
Rear Loading
Double Column Unit displayed

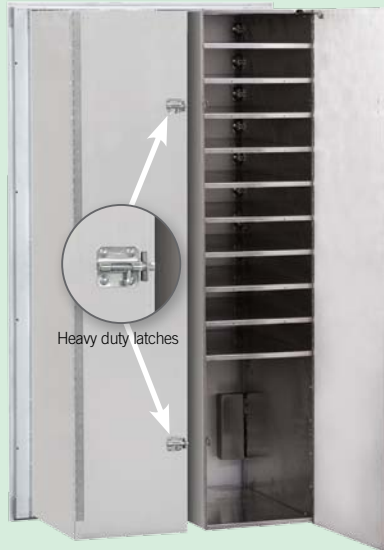

3716D-20
Rear Loading
Rear Access Doors displayed

SAMPLE INSTALLATION

Model displayed:
(2) 3716D-20 Front Loading Units

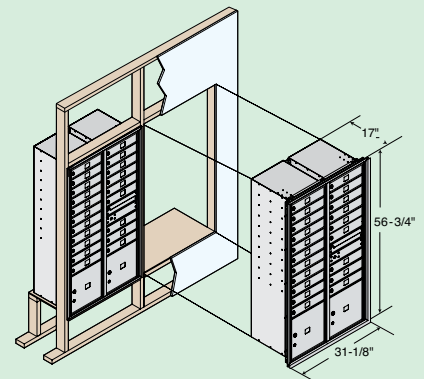

Note: For U.S.P.S. serviced installations, the tenant locks in the top row of mailboxes must be no more than 67" above the finished floor and the bottom shelf of the lowest row of mailboxes must be no less than 28" above the finished floor. The U.S.P.S. master arrow lock must be a minimum of 36" and a maximum of 48" above the finished floor. The bottom shelf of parcel lockers must be at least 15" above the finished floor.

Surface mounted and free-standing enclosures for 4C standard and custom horizontal mailboxes are available – see pages 20-23
4C standard and custom horizontal mailboxes can be mounted on pedestals – see pages 24-27

If Front Loading: Units include one or two (2) master door(s) that swing(s) on continuous integral hinges. The two (2) high outgoing mail compartment includes the access door and cannot be used for mail distribution. The rear of the unit incorporates a solid rear cover.



Front views of 3716D-20 front loading unit in aluminum finish displayed

4C HORIZONTAL MAILBOX SPECIFICATIONS & OPTIONS

MAILBOX DOOR SIZES

Each aluminum door includes a heavy duty five (5) pin cylinder cam lock with a dust/rain shield and three (3) keys.

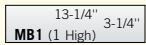

#3751 ¹ Replacement MB1 door and lock \$40.00

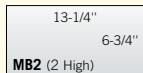

#3752 ¹ Replacement MB2 door and lock \$50.00

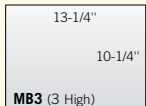

#3753 ¹ Replacement MB3 door and lock \$60.00

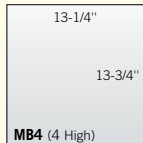

#3754 ¹ Replacement MB4 door and lock \$70.00

PARCEL LOCKER DOOR SIZES

Parcel lockers offer tenants a convenient way to receive packages on site and are fit with a two (2) key security system.

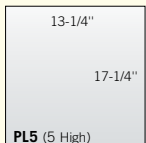

#3755 ¹ Replacement PL5 door and tenant lock \$90.00



#3756 ¹ Replacement PL6 door and tenant lock \$100.00

¹ Specify



FINISHES

The durable and corrosion resistant 4C units feature a durable powder coated finish available in aluminum, bronze, gold or sandstone. Custom finishes (#3766 - add 10% to unit price) are available as an option upon request.

DOOR IDENTIFICATION

Each 4C standard horizontal mailbox door has a 1" high number. The outgoing mail compartment is labeled "Outgoing Mail" and the parcel locker(s) are labeled with a "1P", "2P", etc. Custom identification systems are available as an option upon request.

CUSTOM ENGRAVED PLACARDS

1-3/4" W x 1-1/2" H custom engraved self-adhesive placards are available as an option upon request. (#3767 - \$3.00)



#3767

CUSTOM ENGRAVED DOORS

- Custom engraved door – regular (#3768 - \$3.00)
- Custom engraved door – black filled (#3774 - \$3.00)

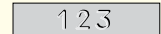

#3768

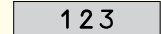

#3774

OUTGOING MAIL COMPARTMENTS

One compartment in each unit is labeled "Outgoing Mail" and includes a weather protection flap and a 10-3/4" W x 3/4" H mail slot.

OPTIONS (for installations not serviced by the U.S.P.S.)

- Mail slots (#3769 - \$3.00)
Standard slot size: 10" W x 3/4" H
Custom slot sizes are available upon request.
- Plexiglass window 1-1/8" W x 7/8" H (#3771 - \$3.00)
- Outgoing mail slot plug kit (#3770 - \$35.00)

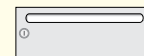

#3769

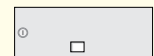

#3771

LOCKS

Each 4C mailbox door includes a heavy duty five (5) pin cylinder cam lock with a dust/rain shield and three (3) keys (2,000 different key changes). (#3790 - \$15.00)



#3790

- Additional keys per lock when ordering (#3798 - \$2.00)
- Key blanks - box of (50) (#3799 - \$30.00)
- Custom lock installation - cylinders provided by owner (for installations not serviced by the U.S.P.S.) (100) door minimum (#3793 - \$4.00 additional per door)

COMBINATION LOCK

Three (3) digit single dial combination lock with spring latch and automatic throw-off (for installations not serviced by the U.S.P.S.). Combination numbers can be changed by owner. (#3786 - \$10.00)



#3786

MASTER COMMERCIAL LOCK

Factory installed if for private access - for front loading mailboxes and parcel lockers - with (2) keys (#3775 - \$25.00)

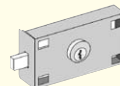

#3775

TENANT PARCEL LOCKER LOCK

For parcel locker door - with (3) keys (#3776 - \$35.00)

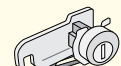

#3776

4C Horizontal Mailbox Enclosures - Surface Mounted



#3816D surface mounted mailbox enclosure with front loading 4C mailbox unit (#3716D-20 - see page 12) in sandstone finish displayed

4C HORIZONTAL MAILBOX ENCLOSURES SURFACE MOUNTED

Made of heavy duty aluminum, Salsbury 3800 series 4C surface mounted mailbox enclosures are designed to easily mount Salsbury 3700 series U.S.P.S. approved and private access front loading 4C standard and custom horizontal mailboxes to a wall. Surface mounted enclosures can accommodate each of the Salsbury 3700 series horizontal mailbox heights in both one door wide (single column) and two (2) doors wide (double column). Mailboxes are sold separately - see pages 12-17. Surface mounted mailbox enclosures feature a durable powder coated finish available in four (4) contemporary colors that match the color of the 4C horizontal mailboxes. 4C standard and custom horizontal mailboxes easily fit into the fully assembled enclosures with mounting hardware (included). Surface mounted mailbox enclosures provide a convenient means of installing 4C standard and custom horizontal mailboxes in locations where walls are not deep enough for a recessed mounted installation. Designed for indoor and outdoor use, surface mounted mailbox enclosures are ideal for apartments, condominiums, commercial buildings, offices and many other applications.

- **Surface Mounted Enclosures come Fully Assembled**
- **Designed for Indoor or Outdoor Use**

4C HORIZONTAL MAILBOX ENCLOSURES - SURFACE MOUNTED

MODEL	DESCRIPTION	UNIT SIZE	WEIGHT	PRICE
FOR MAXIMUM HEIGHT 4C MAILBOXES				
3816D ¹	Surface mounted enclosure for 3716D 4C Mailboxes	32-1/4" W x 57-7/8" H x 17-1/2" D	50 lbs.	\$500.00
3816S ¹	Surface mounted enclosure for 3716S 4C Mailboxes	17-1/2" W x 57-7/8" H x 17-1/2" D	40 lbs.	\$425.00
FOR 15 DOOR HIGH 4C MAILBOXES				
3815D ¹	Surface mounted enclosure for 3715D 4C Mailboxes	32-1/4" W x 56-1/8" H x 17-1/2" D	50 lbs.	\$500.00
3815S ¹	Surface mounted enclosure for 3715S 4C Mailboxes	17-1/2" W x 56-1/8" H x 17-1/2" D	40 lbs.	\$425.00
FOR 14 DOOR HIGH 4C MAILBOXES				
3814D ¹	Surface mounted enclosure for 3714D 4C Mailboxes	32-1/4" W x 52-5/8" H x 17-1/2" D	45 lbs.	\$475.00
3814S ¹	Surface mounted enclosure for 3714S 4C Mailboxes	17-1/2" W x 52-5/8" H x 17-1/2" D	35 lbs.	\$400.00
FOR 13 DOOR HIGH 4C MAILBOXES				
3813D ¹	Surface mounted enclosure for 3713D 4C Mailboxes	32-1/4" W x 49-1/8" H x 17-1/2" D	45 lbs.	\$475.00
3813S ¹	Surface mounted enclosure for 3713S 4C Mailboxes	17-1/2" W x 49-1/8" H x 17-1/2" D	35 lbs.	\$400.00
FOR 12 DOOR HIGH 4C MAILBOXES				
3812D ¹	Surface mounted enclosure for 3712D 4C Mailboxes	32-1/4" W x 45-5/8" H x 17-1/2" D	40 lbs.	\$450.00
3812S ¹	Surface mounted enclosure for 3712S 4C Mailboxes	17-1/2" W x 45-5/8" H x 17-1/2" D	30 lbs.	\$375.00
FOR 11 DOOR HIGH 4C MAILBOXES				
3811D ¹	Surface mounted enclosure for 3711D 4C Mailboxes	32-1/4" W x 42-1/8" H x 17-1/2" D	40 lbs.	\$450.00
3811S ¹	Surface mounted enclosure for 3711S 4C Mailboxes	17-1/2" W x 42-1/8" H x 17-1/2" D	30 lbs.	\$375.00
FOR 10 DOOR HIGH 4C MAILBOXES				
3810D ¹	Surface mounted enclosure for 3710D 4C Mailboxes	32-1/4" W x 38-5/8" H x 17-1/2" D	35 lbs.	\$425.00
3810S ¹	Surface mounted enclosure for 3710S 4C Mailboxes	17-1/2" W x 38-5/8" H x 17-1/2" D	25 lbs.	\$350.00



3816D



3816S

order mailboxes separately - see pages 12-17

SAMPLE INSTALLATION

Models displayed:
(1) 3816D
(1) 3716D-20

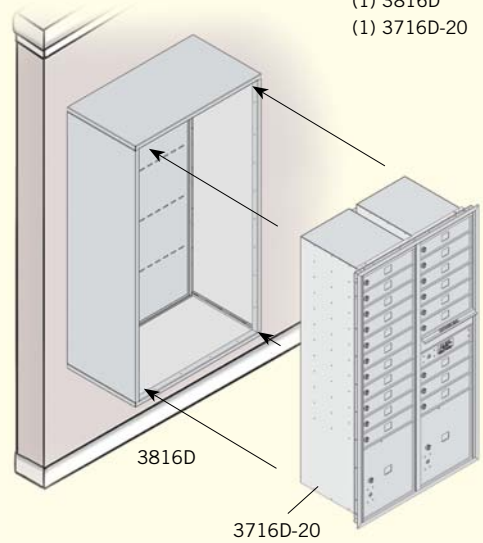

Note: For U.S.P.S. serviced installations, the tenant locks in the top row of mailboxes must be no more than 67" above the finished floor and the bottom shelf of the lowest row of mailboxes must be no less than 28" above the finished floor. The U.S.P.S. master arrow lock must be a minimum of 36" and a maximum of 48" above the finished floor. The bottom shelf of parcel lockers must be at least 15" above the finished floor.

4C HORIZONTAL MAILBOX ENCLOSURES - SURFACE MOUNTED

MODEL	DESCRIPTION	UNIT SIZE	WEIGHT	PRICE
FOR 9 DOOR HIGH 4C MAILBOXES				
3809D ¹	Surface mounted enclosure for 3709D 4C Mailboxes	32-1/4" W x 35-1/8" H x 17-1/2" D	35 lbs.	\$425.00
3809S ¹	Surface mounted enclosure for 3709S 4C Mailboxes	17-1/2" W x 35-1/8" H x 17-1/2" D	25 lbs.	\$350.00
FOR 8 DOOR HIGH 4C MAILBOXES				
3808D ¹	Surface mounted enclosure for 3708D 4C Mailboxes	32-1/4" W x 31-5/8" H x 17-1/2" D	30 lbs.	\$425.00
3808S ¹	Surface mounted enclosure for 3708S 4C Mailboxes	17-1/2" W x 31-5/8" H x 17-1/2" D	20 lbs.	\$350.00
FOR 7 DOOR HIGH 4C MAILBOXES				
3807D ¹	Surface mounted enclosure for 3707D 4C Mailboxes	32-1/4" W x 28-1/8" H x 17-1/2" D	30 lbs.	\$400.00
3807S ¹	Surface mounted enclosure for 3707S 4C Mailboxes	17-1/2" W x 28-1/8" H x 17-1/2" D	20 lbs.	\$325.00
FOR 6 DOOR HIGH 4C MAILBOXES				
3806D ¹	Surface mounted enclosure for 3706D 4C Mailboxes	32-1/4" W x 24-5/8" H x 17-1/2" D	25 lbs.	\$400.00
3806S ¹	Surface mounted enclosure for 3706S 4C Mailboxes	17-1/2" W x 24-5/8" H x 17-1/2" D	15 lbs.	\$325.00
FOR 5 DOOR HIGH 4C MAILBOXES				
3805D ¹	Surface mounted enclosure for 3705D 4C Mailboxes	32-1/4" W x 21-1/8" H x 17-1/2" D	25 lbs.	\$375.00
3805S ¹	Surface mounted enclosure for 3705S 4C Mailboxes	17-1/2" W x 21-1/8" H x 17-1/2" D	15 lbs.	\$300.00
FOR 4 DOOR HIGH 4C MAILBOXES				
3804D ¹	Surface mounted enclosure for 3704D 4C Mailboxes	32-1/4" W x 17-5/8" H x 17-1/2" D	20 lbs.	\$375.00
3804S ¹	Surface mounted enclosure for 3704S 4C Mailboxes	17-1/2" W x 17-5/8" H x 17-1/2" D	10 lbs.	\$300.00

¹ Specify



aluminum



bronze



gold



sandstone



4C Horizontal Mailbox Enclosures - Free-Standing



4C HORIZONTAL MAILBOX ENCLOSURES FREE-STANDING

Made of heavy duty aluminum, Salsbury 3900 series 4C free-standing mailbox enclosures are designed to accommodate Salsbury 3700 series U.S.P.S. approved and private access front loading 4C standard and custom horizontal mailboxes. Free-standing mailbox enclosures mount to the ground and can accommodate each of the Salsbury 3700 series horizontal mailbox heights in both one door wide (single column) and two (2) doors wide (double column). Mailboxes are sold separately - see pages 12-17. Free-standing mailbox enclosures feature a durable powder coated finish available in four (4) contemporary colors that match the color of the 4C horizontal mailboxes. 4C standard and custom horizontal mailboxes easily fit into the fully assembled enclosures with mounting hardware (included). Free-standing mailbox enclosures provide a convenient means of installing 4C standard and custom horizontal mailboxes in locations where a wall mounting application is not desired or available. Designed for indoor and outdoor use, free-standing mailbox enclosures are ideal for apartments, condominiums, commercial buildings, offices and many other applications.

- *Free-Standing Enclosures come Fully Assembled*
- *Designed for Indoor or Outdoor Use*

#3916D free-standing mailbox enclosure with front loading 4C mailbox unit (#3716D-20 - see page 12) in aluminum finish displayed

4C HORIZONTAL MAILBOX ENCLOSURES - FREE-STANDING

MODEL	DESCRIPTION	UNIT SIZE	WEIGHT	PRICE
FOR MAXIMUM HEIGHT 4C MAILBOXES				
3916D ¹	Free-Standing enclosure for 3716D 4C Mailboxes	32-1/4" W x 72" H x 19" D	90 lbs.	\$675.00
3916S ¹	Free-Standing enclosure for 3716S 4C Mailboxes	17-1/2" W x 72" H x 19" D	65 lbs.	\$575.00
FOR 15 DOOR HIGH 4C MAILBOXES				
3915D ¹	Free-Standing enclosure for 3715D 4C Mailboxes	32-1/4" W x 72" H x 19" D	90 lbs.	\$675.00
3915S ¹	Free-Standing enclosure for 3715S 4C Mailboxes	17-1/2" W x 72" H x 19" D	65 lbs.	\$575.00
FOR 14 DOOR HIGH 4C MAILBOXES				
3914D ¹	Free-Standing enclosure for 3714D 4C Mailboxes	32-1/4" W x 69-1/4" H x 19" D	85 lbs.	\$675.00
3914S ¹	Free-Standing enclosure for 3714S 4C Mailboxes	17-1/2" W x 69-1/4" H x 19" D	60 lbs.	\$575.00
FOR 13 DOOR HIGH 4C MAILBOXES				
3913D ¹	Free-Standing enclosure for 3713D 4C Mailboxes	32-1/4" W x 69-1/4" H x 19" D	85 lbs.	\$650.00
3913S ¹	Free-Standing enclosure for 3713S 4C Mailboxes	17-1/2" W x 69-1/4" H x 19" D	60 lbs.	\$550.00
FOR 12 DOOR HIGH 4C MAILBOXES				
3912D ¹	Free-Standing enclosure for 3712D 4C Mailboxes	32-1/4" W x 69-1/4" H x 19" D	85 lbs.	\$650.00
3912S ¹	Free-Standing enclosure for 3712S 4C Mailboxes	17-1/2" W x 69-1/4" H x 19" D	60 lbs.	\$550.00
FOR 11 DOOR HIGH 4C MAILBOXES				
3911D ¹	Free-Standing enclosure for 3711D 4C Mailboxes	32-1/4" W x 69-1/4" H x 19" D	85 lbs.	\$650.00
3911S ¹	Free-Standing enclosure for 3711S 4C Mailboxes	17-1/2" W x 69-1/4" H x 19" D	60 lbs.	\$550.00
FOR 10 DOOR HIGH 4C MAILBOXES				
3910D ¹	Free-Standing enclosure for 3710D 4C Mailboxes	32-1/4" W x 65-3/4" H x 19" D	80 lbs.	\$625.00
3910S ¹	Free-Standing enclosure for 3710S 4C Mailboxes	17-1/2" W x 65-3/4" H x 19" D	55 lbs.	\$525.00



3916D



3916S

order mailboxes separately - see pages 12-17

SAMPLE INSTALLATION

Models displayed:
(1) 3916D
(1) 3716D-20

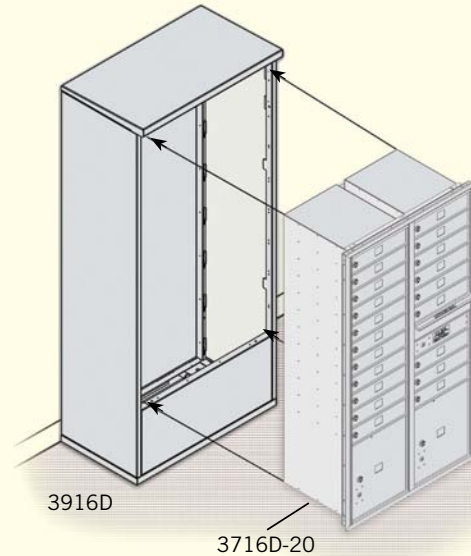

Note: It is recommended that all free-standing enclosures be wall and/or floor anchored.

4C HORIZONTAL MAILBOX ENCLOSURES - FREE-STANDING

MODEL	DESCRIPTION	UNIT SIZE	WEIGHT	PRICE
FOR 9 DOOR HIGH 4C MAILBOXES				
3909D ¹	Free-Standing enclosure for 3709D 4C Mailboxes	32-1/4" W x 62-1/4" H x 19" D	75 lbs.	\$625.00
3909S ¹	Free-Standing enclosure for 3709S 4C Mailboxes	17-1/2" W x 62-1/4" H x 19" D	50 lbs.	\$525.00
FOR 8 DOOR HIGH 4C MAILBOXES				
3908D ¹	Free-Standing enclosure for 3708D 4C Mailboxes	32-1/4" W x 58-3/4" H x 19" D	70 lbs.	\$625.00
3908S ¹	Free-Standing enclosure for 3708S 4C Mailboxes	17-1/2" W x 58-3/4" H x 19" D	45 lbs.	\$525.00
FOR 7 DOOR HIGH 4C MAILBOXES				
3907D ¹	Free-Standing enclosure for 3707D 4C Mailboxes	32-1/4" W x 55-1/4" H x 19" D	65 lbs.	\$600.00
3907S ¹	Free-Standing enclosure for 3707S 4C Mailboxes	17-1/2" W x 55-1/4" H x 19" D	40 lbs.	\$500.00
FOR 6 DOOR HIGH 4C MAILBOXES				
3906D ¹	Free-Standing enclosure for 3706D 4C Mailboxes	32-1/4" W x 55-1/4" H x 19" D	65 lbs.	\$600.00
3906S ¹	Free-Standing enclosure for 3706S 4C Mailboxes	17-1/2" W x 55-1/4" H x 19" D	40 lbs.	\$500.00
FOR 5 DOOR HIGH 4C MAILBOXES				
3905D ¹	Free-Standing enclosure for 3705D 4C Mailboxes	32-1/4" W x 48-1/4" H x 19" D	60 lbs.	\$575.00
3905S ¹	Free-Standing enclosure for 3705S 4C Mailboxes	17-1/2" W x 48-1/4" H x 19" D	35 lbs.	\$475.00
FOR 4 DOOR HIGH 4C MAILBOXES				
3904D ¹	Free-Standing enclosure for 3704D 4C Mailboxes	32-1/4" W x 48-1/4" H x 19" D	55 lbs.	\$575.00
3904S ¹	Free-Standing enclosure for 3704S 4C Mailboxes	17-1/2" W x 48-1/4" H x 19" D	30 lbs.	\$475.00

¹ Specify



aluminum



bronze



gold



sandstone



4C Pedestal Mailboxes - continued on pages 26-27

4C PEDESTAL MAILBOXES FRONT LOADING



#3410S-08 and #3410D-4P in bronze finish displayed



Made of heavy gauge aluminum and stainless steel hardware, Salsbury 3400 series 4C pedestal mailboxes are accessed from the front through one or two (2) easy opening master door panels. The durable and corrosion resistant units feature a powder coated finish available in six (6) contemporary colors. 4C pedestal mailboxes are available with standard mailbox doors (MB1) that are 13-1/4" W x 3-1/4" H and larger MB2 and MB3 mailbox doors - see door sizes on page 27. All mailbox doors include a heavy duty cam lock with a dust/rain shield and three (3) keys. A compartment equivalent to two (2) 3-1/4" high standard MB1 mailbox doors is used for outgoing mail collection and is labeled "Outgoing Mail". The outgoing mail compartment includes a weather protection flap and an 11-3/4" W x 3/4" H mail slot. 4C pedestal mailboxes include a matching pedestal and master commercial lock(s) and are available in configurations that are one door wide (single column) and two (2) doors wide (double column). Fully integrated and stand-alone parcel lockers are available in five (5) equivalent standard mailbox door heights (PL5 - 17-1/4" high) and six (6) equivalent standard mailbox door heights (PL6 - 20-3/4" high). The most popular height is the Salsbury maximum height 3416D-20 unit which features twenty (20) MB1 mailbox doors and two (2) fully integrated 15-1/2" high parcel lockers. Many other standard units in six (6) to fifteen (15) equivalent standard MB1 mailbox door heights are also available. 4C pedestal mailboxes are ideal when private centralized mail delivery is desired.

4C PEDESTAL MAILBOXES - INCLUDES 4C MAILBOX, PEDESTAL AND MASTER COMMERCIAL LOCK(S)

MODEL	DESCRIPTION	UNIT SIZE	WEIGHT	PRICE
MAXIMUM HEIGHT UNITS - 72" H including 13" H pedestal				
3416D-20 ¹	20 MB1 Doors and 2 Parcel Lockers (15-1/2" H)	32-1/4" W x 72" H x 19" D	225 lbs.	\$1,975.00
3416S-09 ¹	9 MB1 Doors and one Parcel Locker (15-1/2" H)	17-1/2" W x 72" H x 19" D	130 lbs.	\$1,250.00
3416D-09 ¹	7 MB2 Doors, 2 MB3 Doors, 2 Parcel Lockers (15-1/2" H)	32-1/4" W x 72" H x 19" D	205 lbs.	\$1,775.00
15 DOOR HIGH UNITS - 70-1/4" H including 13" H pedestal				
3415D-18 ¹	18 MB1 Doors and 2 Parcel Lockers (PL5)	32-1/4" W x 70-1/4" H x 19" D	210 lbs.	\$1,925.00
3415D-16 ¹	16 MB1 Doors and 2 Parcel Lockers (PL6)	32-1/4" W x 70-1/4" H x 19" D	210 lbs.	\$1,875.00
3415S-08 ¹	8 MB1 Doors and one Parcel Locker (PL5)	17-1/2" W x 70-1/4" H x 19" D	120 lbs.	\$1,175.00
3415S-07 ¹	7 MB1 Doors and one Parcel Locker (PL6)	17-1/2" W x 70-1/4" H x 19" D	120 lbs.	\$1,150.00
3415D-09 ¹	9 MB2 Doors and 2 Parcel Lockers (PL5)	32-1/4" W x 70-1/4" H x 19" D	200 lbs.	\$1,700.00
14 DOOR HIGH UNITS - 66-3/4" H including 13" H pedestal				
3414D-16 ¹	16 MB1 Doors and 2 Parcel Lockers (PL5)	32-1/4" W x 66-3/4" H x 19" D	205 lbs.	\$1,825.00
3414D-15 ¹	15 MB1 Doors and 2 Parcel Lockers (PL5, PL6)	32-1/4" W x 66-3/4" H x 19" D	205 lbs.	\$1,800.00
3414S-03 ¹	3 MB2 Doors and one Parcel Locker (PL6)	17-1/2" W x 66-3/4" H x 19" D	110 lbs.	\$1,025.00
3414S-2P ¹	Stand-alone Parcel Lockers 2 (PL6's)	17-1/2" W x 66-3/4" H x 19" D	115 lbs.	\$1,000.00
3414D-07 ¹	7 MB2 Doors and 2 Parcel Lockers (PL6)	32-1/4" W x 66-3/4" H x 19" D	195 lbs.	\$1,600.00

MAXIMUM HEIGHT UNITS

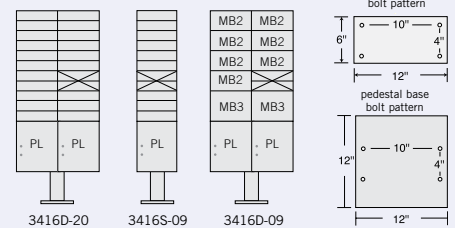

15 DOOR HIGH UNITS

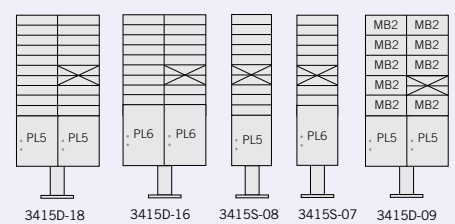

14 DOOR HIGH UNITS

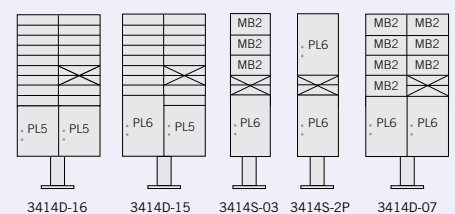



Note: Salisbury 4C Pedestal Mailboxes include a U.S.P.S. approved 4C horizontal mailbox unit, a matching enclosure and pedestal and master commercial lock(s) for private access. For delivery of U.S. mail, contact your local postmaster for approval.



3416D-20

includes pedestal



3416S-09

includes pedestal



3416D-09

includes pedestal

4C PEDESTAL MAILBOXES - INCLUDES 4C MAILBOX, PEDESTAL AND MASTER COMMERCIAL LOCK(S)

MODEL	DESCRIPTION	UNIT SIZE	WEIGHT	PRICE
13 DOOR HIGH UNITS - 63-1/4" H including 13" H pedestal				
3413D-14 ¹	14 MB1 Doors and 2 Parcel Lockers (PL5)	32-1/4" W x 63-1/4" H x 19" D	195 lbs.	\$1,700.00
3413D-13 ¹	13 MB1 Doors and 2 Parcel Lockers (PL5, PL6)	32-1/4" W x 63-1/4" H x 19" D	195 lbs.	\$1,675.00
3413S-06 ¹	6 MB1 Doors and one Parcel Locker (PL5)	17-1/2" W x 63-1/4" H x 19" D	110 lbs.	\$1,050.00
3413S-05 ¹	5 MB1 Doors and one Parcel Locker (PL6)	17-1/2" W x 63-1/4" H x 19" D	110 lbs.	\$1,025.00
12 DOOR HIGH UNITS - 59-3/4" H including 13" H pedestal				
3412D-12 ¹	12 MB1 Doors and 2 Parcel Lockers (PL5)	32-14" W x 59-3/4" H x 19" D	175 lbs.	\$1,600.00
3412D-4P ¹	Stand-alone Parcel Lockers 4 (PL6)	32-14" W x 59-3/4" H x 19" D	175 lbs.	\$1,325.00
3412S-02 ¹	2 MB2 Doors and one Parcel Locker (PL6)	17-1/2" W x 59-3/4" H x 19" D	105 lbs.	\$925.00
3412S-2P ¹	Stand-alone Parcel Lockers 2 (PL6's)	17-1/2" W x 59-3/4" H x 19" D	105 lbs.	\$875.00
11 DOOR HIGH UNITS - 69-1/8" H including 26" H pedestal				
3411D-20 ¹	20 MB1 Doors - no Parcel Lockers	32-1/4" W x 69-1/8" H x 19" D	195 lbs.	\$1,625.00
3411D-09 ¹	9 MB1 Doors and 2 Parcel Lockers (PL5, PL6)	32-1/4" W x 69-1/8" H x 19" D	175 lbs.	\$1,450.00
3411S-09 ¹	9 MB1 Doors - no Parcel Lockers	17-1/2" W x 69-1/8" H x 19" D	105 lbs.	\$1,000.00
3411S-2P ¹	Stand-alone Parcel Lockers (PL5, PL6)	17-1/2" W x 69-1/8" H x 19" D	95 lbs.	\$825.00

¹ Specify



sandstone



bronze



green



black



white



gray

13 DOOR HIGH UNITS

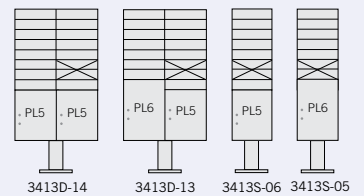

12 DOOR HIGH UNITS

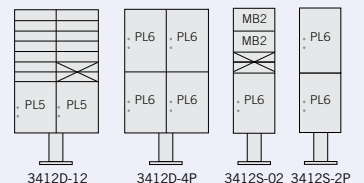

11 DOOR HIGH UNITS

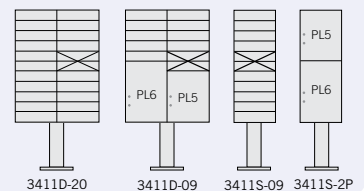

more 4C pedestal mailboxes available on pages 26-27 and on-line

4C Pedestal Mailboxes



#3416D-20 in white finish with optional custom engraved doors - black filled (#3474) displayed

- Ideal for Military Bases, Student Housing and other Centralized Mail Delivery Applications
- Matching Pedestal Included
- Master Commercial Lock(s) Included
- Outgoing Mail Compartment
- Fully Integrated Parcel Locker(s)
- For Indoor or Outdoor Use
- Engraved Doors or Placards Available
- Custom Configurations and Finishes Available (see pages 16-17)
- Matching Pedestal Collection Boxes Available (see pages 52-53)

4C PEDESTAL MAILBOXES - INCLUDES 4C MAILBOX, PEDESTAL AND MASTER COMMERCIAL LOCK(S)

MODEL	DESCRIPTION	UNIT SIZE	WEIGHT	PRICE
10 DOOR HIGH UNITS - 65-5/8" H including 26" H pedestal				
3410D-18 ¹	18 MB1 Doors - no Parcel Lockers	32-1/4" W x 65-5/8" H x 19" D	175 lbs.	\$1,525.00
3410D-4P ¹	Stand-alone Parcel Lockers 4 (PL5)	32-1/4" W x 65-5/8" H x 19" D	165 lbs.	\$1,200.00
3410S-08 ¹	8 MB1 Doors - no Parcel Lockers	17-1/2" W x 65-5/8" H x 19" D	110 lbs.	\$950.00
3410D-07 ¹	7 MB1 Doors - 2 Parcel Lockers (PL5, PL6)	32-1/4" W x 65-5/8" H x 19" D	170 lbs.	\$1,350.00
3410S-2P ¹	Stand-alone Parcel Lockers 2 (PL5's)	17-1/2" W x 65-5/8" H x 19" D	95 lbs.	\$800.00
9 DOOR HIGH UNITS - 62-1/8" H including 26" H pedestal				
3409D-16 ¹	16 MB1 Doors - no Parcel Lockers	32-1/4" W x 62-1/8" H x 19" D	165 lbs.	\$1,400.00
3409D-10 ¹	10 MB1 Doors and one Parcel Locker (PL6)	32-1/4" W x 62-1/8" H x 19" D	155 lbs.	\$1,300.00
3409S-07 ¹	7 MB1 Doors - no Parcel Lockers	17-1/2" W x 62-1/8" H x 19" D	100 lbs.	\$875.00
3409D-04 ¹	1 MB1 Door, 3 MB3 Doors and one Parcel Locker (PL6)	32-1/4" W x 62-1/8" H x 19" D	150 lbs.	\$1,150.00
3409S-02 ¹	2 MB1 Doors and one Parcel Locker (PL6)	17-1/2" W x 62-1/8" H x 19" D	90 lbs.	\$800.00
8 DOOR HIGH UNITS - 58-5/8" H including 26" H pedestal				
3408D-14 ¹	14 MB1 Doors - no Parcel Lockers	32-1/4" W x 58-5/8" H x 19" D	155 lbs.	\$1,300.00
3408D-09 ¹	9 MB1 Doors and one Parcel Locker (PL5)	32-1/4" W x 58-5/8" H x 19" D	135 lbs.	\$1,225.00
3408S-06 ¹	6 MB1 Doors - no Parcel Lockers	17-1/2" W x 58-5/8" H x 19" D	95 lbs.	\$825.00
3408S-03 ¹	3 MB2 Doors - no Parcel Lockers	17-1/2" W x 58-5/8" H x 19" D	95 lbs.	\$750.00
3408D-04 ¹	4 MB2 Doors and one Parcel Locker (PL6)	32-1/4" W x 58-5/8" H x 19" D	135 lbs.	\$1,100.00

10 DOOR HIGH UNITS

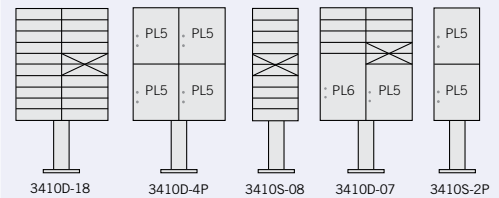

9 DOOR HIGH UNITS

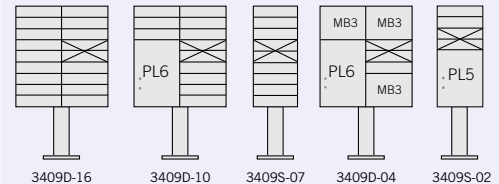

8 DOOR HIGH UNITS

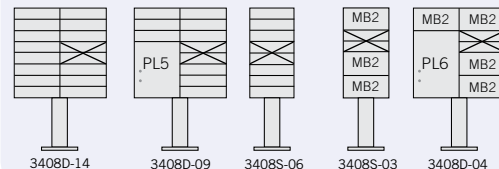

STANDARD FEATURES

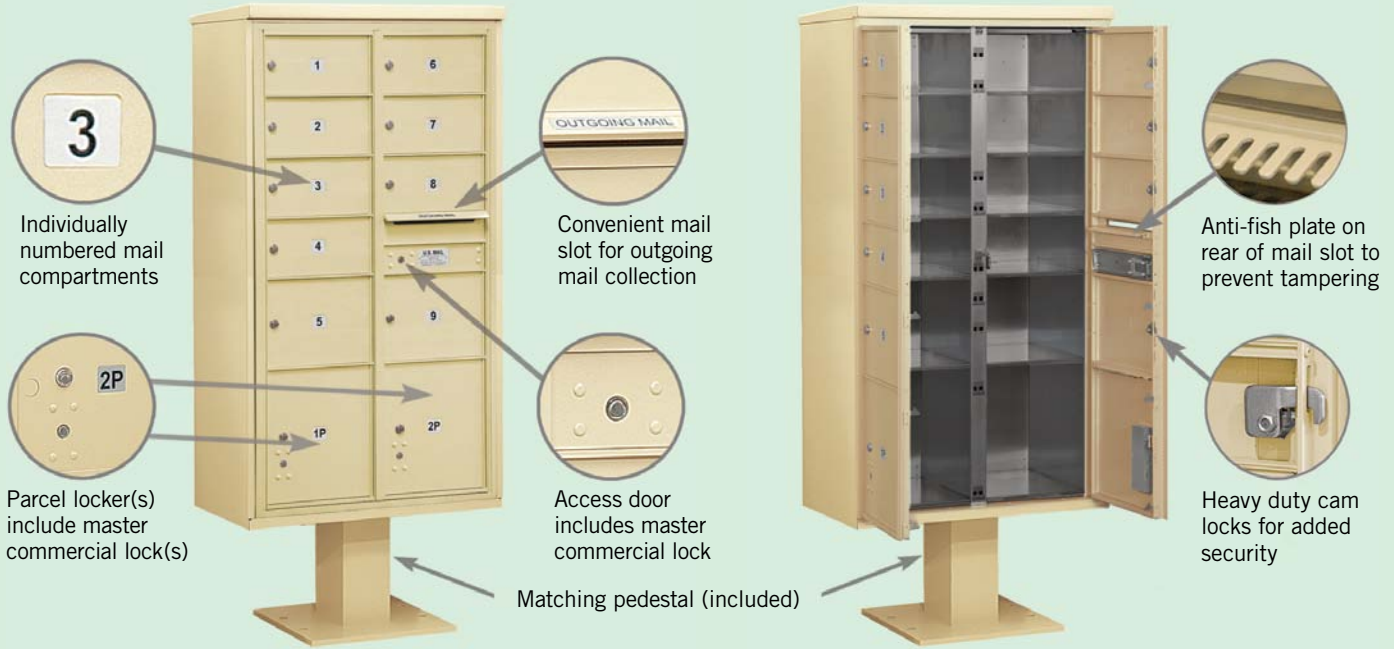

Front views of 3416D-09 in sandstone finish displayed

4C PEDESTAL MAILBOXES - INCLUDES 4C MAILBOX, PEDESTAL AND MASTER COMMERCIAL LOCK(S)

MODEL	DESCRIPTION	UNIT SIZE	WEIGHT	PRICE
-------	-------------	-----------	--------	-------

7 DOOR HIGH UNITS - 55-1/8" H including 26" H pedestal

3407D-12 ¹	12 MB1 Doors - no Parcel Lockers	32-1/4" W x 55-1/8" H x 19" D	135 lbs.	\$1,175.00
3407D-06 ¹	6 MB1 Doors and one Parcel Locker (PL6)	32-1/4" W x 55-1/8" H x 19" D	125 lbs.	\$1,075.00
3407S-05 ¹	5 MB1 Doors - no Parcel Lockers	17-1/2" W x 55-1/8" H x 19" D	85 lbs.	\$750.00
3407S-1P ¹	Stand-alone Parcel Locker (PL5)	17-1/2" W x 55-1/8" H x 19" D	80 lbs.	\$675.00

6 DOOR HIGH UNITS - 51-5/8" H including 26" H pedestal

3406D-10 ¹	10 MB1 Doors - no Parcel Lockers	32-1/4" W x 51-5/8" H x 19" D	125 lbs.	\$1,075.00
3406D-04 ¹	4 MB1 Doors and one Parcel Locker (PL6)	32-1/4" W x 51-5/8" H x 19" D	115 lbs.	\$975.00
3406S-04 ¹	4 MB1 Doors - no Parcel Lockers	17-1/2" W x 51-5/8" H x 19" D	80 lbs.	\$650.00
3406S-1P ¹	Stand-alone Parcel Locker (PL6)	17-1/2" W x 51-5/8" H x 19" D	70 lbs.	\$600.00

SPARE PARTS / OPTIONS

3485 ¹	Pedestal - replacement for #3416, #3415, #3414, #3413 and #3412	13" H	25 lbs.	\$100.00
3495 ¹	Pedestal - replacement for #3411, #3410, #3409, #3408, #3407 and #3406	26" H	30 lbs.	\$100.00
3467	Custom engraved placard - for 3400 series mailbox doors and parcel lockers			\$3.00
3468	Custom engraved door - regular - for 3400 series mailbox doors and parcel lockers			\$3.00
3474	Custom engraved door - black filled - for 3400 series mailbox doors and parcel lockers			\$3.00
3476	Tenant parcel locker lock - with (3) keys			\$35.00
3477	Master commercial lock - standard replacement for master access door and parcel lockers - with (2) keys			\$25.00
3490	Lock - standard replacement for 3400 series mailbox door - with (3) keys			\$15.00
3494	Pedestal mounting kit - (4) anchor (j) bolts - for new concrete installations		3 lbs.	\$25.00
3499	Key blanks - for standard 3400 series locks - box of (50)			\$30.00

¹ Specify



7 DOOR HIGH UNITS

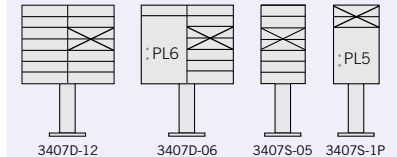

6 DOOR HIGH UNITS

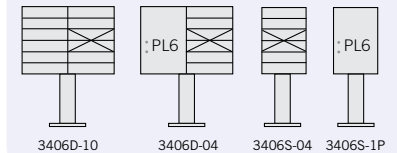

OUTGOING MAIL COMPARTMENT (OM2)

Note: 4C pedestal mailboxes include a two (2) door high compartment for outgoing mail collection that is labeled "Outgoing Mail".

MAILBOX DOOR SIZES:

MB1	13-1/4" W x 3-1/4" H
MB2	13-1/4" W x 6-3/4" H
MB3	13-1/4" W x 10-1/4" H

PARCEL LOCKER DOOR SIZES:

PL5	13-1/4" W x 17-1/4" H
PL6	13-1/4" W x 20-3/4" H

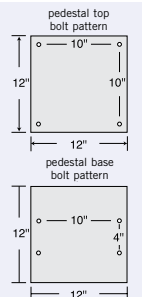

Note: 3600 series 4B+ standard horizontal mailboxes have been U.S.P.S. approved to the required security upgrades of USPS-STD-4B+. These mailboxes are approved for replacement and/or retrofit installations. For new construction and major renovations, see 4C horizontal mailboxes on pages 12-17.



3614
14 Front Loading
B doors (13 usable)



Sample Rear
Loading Unit

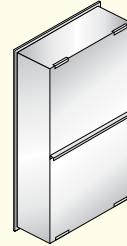

Rear loading unit with removable lift off rear cover displayed

SAMPLE INSTALLATION

Model displayed:
(2) 3635's front loading units

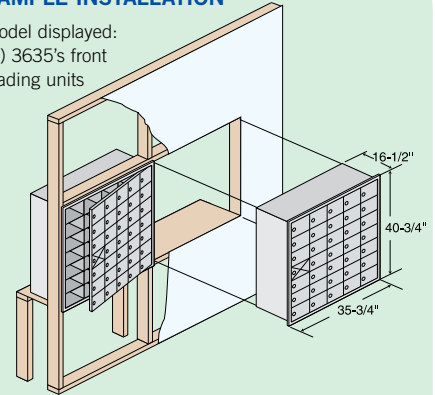

Note: For U.S.P.S. serviced installations, the tenant locks in the top row of mailboxes must be no more than 67" above the finished floor and the bottom of the lowest row must be no less than 28" above the finished floor.

4B+ STANDARD HORIZONTAL MAILBOXES - FRONT OR REAR LOADING - U.S.P.S. APPROVED

MODEL	DESCRIPTION	UNIT SIZE - FL and RL (includes trim)	WEIGHT	PRICE
7 DOOR HIGH UNITS - 40-3/4" H				
3621 ^{1,2,3}	21 A Doors (20 usable on FL)	22-3/4" W x 40-3/4" H x 16-1/2" D	70 lbs.	\$735.00
3628 ^{1,2,3}	28 A Doors (27 usable on FL)	29-1/4" W x 40-3/4" H x 16-1/2" D	85 lbs.	\$980.00
3635 ^{1,2,3}	35 A Doors (34 usable on FL)	35-3/4" W x 40-3/4" H x 16-1/2" D	100 lbs.	\$1,225.00
3614 ^{1,2,3}	14 B Doors (13 usable on FL)	29-1/4" W x 40-3/4" H x 16-1/2" D	85 lbs.	\$770.00
6 DOOR HIGH UNITS - 35-1/4" H				
3618 ^{1,2,3}	18 A Doors (17 usable on FL)	22-3/4" W x 35-1/4" H x 16-1/2" D	60 lbs.	\$630.00
3624 ^{1,2,3}	24 A Doors (23 usable on FL)	29-1/4" W x 35-1/4" H x 16-1/2" D	75 lbs.	\$840.00
3630 ^{1,2,3}	30 A Doors (29 usable on FL)	35-3/4" W x 35-1/4" H x 16-1/2" D	90 lbs.	\$1,050.00
3612 ^{1,2,3}	12 B Doors (11 usable on FL)	29-1/4" W x 35-1/4" H x 16-1/2" D	75 lbs.	\$660.00
5 DOOR HIGH UNITS - 29-3/4" H				
3615 ^{1,2,3}	15 A Doors (14 usable on FL)	22-3/4" W x 29-3/4" H x 16-1/2" D	55 lbs.	\$525.00
3620 ^{1,2,3}	20 A Doors (19 usable on FL)	29-1/4" W x 29-3/4" H x 16-1/2" D	65 lbs.	\$700.00
3625 ^{1,2,3}	25 A Doors (24 usable on FL)	35-3/4" W x 29-3/4" H x 16-1/2" D	75 lbs.	\$875.00
3610 ^{1,2,3}	10 B Doors (9 usable on FL)	29-1/4" W x 29-3/4" H x 16-1/2" D	65 lbs.	\$550.00

3668	Custom engraved door - regular - for 3600 series mailbox doors and parcel lockers	\$3.00
3674	Custom engraved door - black filled - for 3600 series mailbox doors and parcel lockers	\$3.00
3675	Master commercial lock - factory installed if for private access - for FL mailboxes - with (2) keys	\$25.00
3686	Combination lock - 3 digit spring latch - additional per door - for installations not serviced by the U.S.P.S.	\$10.00
3690	Lock - standard replacement for 3600 series doors - with (2) keys	\$8.00
3699	Key blanks - for standard 3600 series locks - box of (50)	\$30.00

- ¹ Specify
- aluminum
 - bronze
 - gold
 - sandstone

² Specify - front loading or rear loading

³ Specify - U.S.P.S. access or private access (order master commercial lock #3675 - on front loading units only)

4B+ STANDARD HORIZONTAL MAILBOX OPTIONS

Each mailbox door includes a five (5) pin cylinder cam lock with two (2) keys (1,000 different key changes).

- Lock - for 3600 series (#3690 - \$8.00)
- Additional keys per lock when ordering (#3698 - \$2.00)
- Key blanks - box of (50) (#3699 - \$30.00)

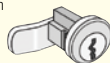

#3690
Lock for
3600 series
\$8.00



#3698
Additional keys
for #3690
\$2.00 per key

- Master commercial lock - with (2) keys - factory installed if for private access - for front loading mailboxes (#3675 - \$25.00)
- Card holder - clear plastic - card and metal insert included (#3697 - \$3.00)
- Self-adhesive numbers - sheets of (100) (#3695 - \$15.00)
- 4B+ Master door security retrofit kit (#3696 - \$50.00)

Note: On front loading 3600 series horizontal mailboxes, one opening per unit is required for a master postal or commercial lock and cannot be used for mail distribution. On rear loading units, all openings are usable.

STANDARD FRONT LOADING CONFIGURATIONS

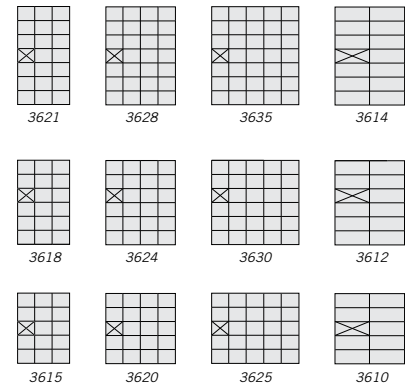

3600 SERIES DOOR SIZES

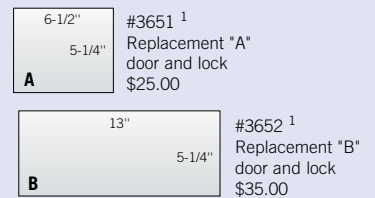

DOOR AND COMPARTMENT IDENTIFICATION

Each mailbox door includes a 2" W x 5/8" H clear plastic card holder (#3697 - \$3.00) to identify the tenant's name and/or box number. Self-adhesive numbers (1-3000 available) are supplied upon request with a standard order. Custom identification systems are available as an option upon request. Label holders (#1070 - \$30.00 - page 61) neatly organize and identify the front/rear of the mailbox compartments and are available as an option upon request.

CUSTOM ENGRAVED PLACARDS (OPTION - #3667)

2" W x 5/8" H custom engraved self-adhesive placards are available as an option upon request. \$3.00



4B+ Custom Horizontal Mailboxes

4B+ CUSTOM HORIZONTAL MAILBOXES FRONT OR REAR LOADING



Made entirely of aluminum, Salsbury 3600 series U.S.P.S. approved 4B+ custom horizontal mailboxes are available in four (4) different mailbox door sizes and three (3) different parcel locker door sizes. Each aluminum mailbox door includes a five (5) pin cylinder cam lock with two (2) keys and a 2" W x 5/8" H clear plastic card holder (card included) to identify the tenant's name and/or box number. The mailbox compartments are made of sheet aluminum. 3600 series 4B+ custom horizontal mailboxes can integrate different combinations of mailbox and parcel locker doors and are available in four (4) contemporary colors. Custom colors are available as an option upon request. Matching collection units (5, 6 and 7 doors high) are also available. Custom horizontal mailboxes are ideal for apartments, condominiums, commercial buildings, colleges and schools and many other applications.

If Front Loading:

Door panel swings on a continuous hinge. One mailbox opening (A and B doors only) is required for a master postal or commercial lock and cannot be used for mail distribution. Units include factory installed 3/4" W x 1/4" D trim and a solid rear cover.



If Rear Loading:

Mailboxes can be used for either U.S.P.S. access (master postal lock not required) or private access (master commercial lock not required). All openings are usable. Units include factory installed 3/4" W x 1/4" D trim and a removable rear cover.

PARCEL LOCKERS can be integrated into a 3600 series mailbox system and are a convenient way to receive packages on site. Parcel lockers are fit with a two (2) key security system that allows the U.S.P.S. or an individual to deliver a parcel to the locker and place a parcel locker key in the recipient's mailbox. Once the recipient opens the parcel locker, the key is automatically retained in the lock until it is removed with a control key.



Custom front loading unit with standard aluminum finish displayed

See sample installation on page 29

ORDERING A 4B+ CUSTOM HORIZONTAL UNIT

1) Determine the number of openings required using A, B, C, and D mailbox doors and PL2, PL3 and PL4 parcel locker doors.

SAMPLE FRONT LOADING UNIT

(trim not shown)
 3 - 3600 A doors (2 usable) 2 - 3600PL2
 1 - 3600 B door 1 - 3600PL3
 2 - 3600 C doors 1 - 3600PL4
 1 - 3600 D door

2) Configure requirements to fit a minimum of 2W x 3H standard A doors to a maximum of 5W x 7H standard A doors.

3) Contact us for rough opening dimensions or layout specifications.

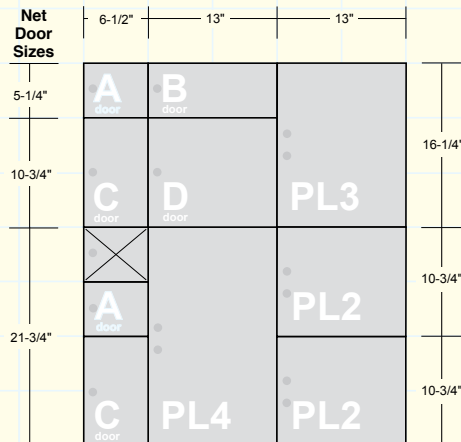

Note: There is a 1/4" vertical space between doors shown above.

**Submit Required
Layout and Options
for a Price Quotation!**



Final inspection of custom horizontal units

4B+ CUSTOM HORIZONTAL MAILBOXES - FRONT OR REAR LOADING - U.S.P.S. APPROVED

MODEL	DESCRIPTION	DOOR SIZE	WEIGHT	PRICE
MAILBOXES				
3600A ^{1,2,3}	A Door and 16-1/2" D Compartment	6-1/2" W x 5-1/4" H	3 lbs.	\$40.00
3600B ^{1,2,3}	B Door and 16-1/2" D Compartment	13" W x 5-1/4" H	6 lbs.	\$60.00
3600C ^{1,2,3}	C Door and 16-1/2" D Compartment	6-1/2" W x 10-3/4" H	6 lbs.	\$60.00
3600D ^{1,2,3}	D Door and 16-1/2" D Compartment	13" W x 10-3/4" H	12 lbs.	\$80.00
PARCEL LOCKERS				
3600PL2 ^{1,2,3}	Parcel Locker (2 doors high and 2 doors wide)	13" W x 10-3/4" H	15 lbs.	\$130.00
3600PL3 ^{1,2,3}	Parcel Locker (3 doors high and 2 doors wide)	13" W x 16-1/4" H	20 lbs.	\$160.00
3600PL4 ^{1,2,3}	Parcel Locker (4 doors high and 2 doors wide)	13" W x 21-3/4" H	25 lbs.	\$190.00
COLLECTION UNITS⁴				
		Unit Size		
3600C5 ^{1,2,3}	Collection Unit (for 5 door high unit)	21" W x 29-3/4" H x 12" D	60 lbs.	\$750.00
3600C6 ^{1,2,3}	Collection Unit (for 6 door high unit)	21" W x 35-1/4" H x 12" D	65 lbs.	\$800.00
3600C7 ^{1,2,3}	Collection Unit (for 7 door high unit)	21" W x 40-3/4" H x 12" D	70 lbs.	\$850.00
SPARE PARTS / OPTIONS				
3651 ¹	Door - A replacement door and lock with (2) keys	6-1/2" W x 5-1/4" H	1 lb.	\$25.00
3652 ¹	Door - B replacement door and lock with (2) keys	13" W x 5-1/4" H	2 lbs.	\$35.00
3653 ¹	Door - C replacement door and lock with (2) keys	6-1/2" W x 10-3/4" H	2 lbs.	\$35.00
3654 ¹	Door - D replacement door and lock with (2) keys	13" W x 10-3/4" H	3 lbs.	\$60.00
3666	Custom finish - specify color			add 10%
3675	Master commercial lock - factory installed if for private access - for FL mailboxes and PL's - with (2) keys			\$25.00
3676	Tenant parcel locker lock - includes assembly with (2) keys			\$35.00
3677	Master commercial lock - factory installed if for private access - for FL collection unit - with (2) keys			\$35.00
3686	Combination lock - 3 digit spring latch - additional per door - for installations not serviced by the U.S.P.S.			\$10.00
3690	Lock - standard replacement for 3600 series doors - with two (2) keys			\$8.00
3699	Key blanks - for standard 3600 series locks - box of (50)			\$30.00

Note: The price of 4B+ custom horizontal mailboxes is the total of each mailbox and parcel locker within a unit. Allow approximately 2-3 weeks production time for custom horizontal mailboxes. For faster service, see pages 28-29 for standard horizontal mailboxes.

¹ Specify



² Specify

- For front loading (FL) installation
- For rear loading (RL) installation

³ Specify

- For U.S.P.S. access
- For private access (order #3675 - for front loading mailbox unit and parcel locker) (order #3677 - for front loading collection unit)

⁴ All front access collection units have an 18" W x 25-1/4" H x 12" D mail storage compartment. On rear access collection units, customer to supply mail receptacle.



4B+ custom horizontal mailboxes with parcel lockers and collection unit in gold finish and regular custom engraving on collection unit (#3665) displayed.

4B+ CUSTOM HORIZONTAL MAILBOX OPTIONS

OPTIONS

- Plexiglass window (#3671 - \$3.00)
- Mail slots (#3669 - \$3.00)

Standard mail slot sizes for 3600 series:

- A Door - 5-1/2" W x 3/4" H
- B Door - 12" W x 3/4" H
- C Door - 5-1/2" W x 3/4" H
- D Door - 12" W x 3/4" H

(for installations not serviced by the U.S.P.S.)



#3671
Plexiglass window
1-1/8" W x 7/8" H
\$3.00



Custom slot sizes are available upon request.

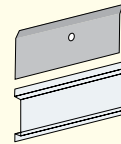

Card holder - clear plastic - card and metal insert included (#3697 - \$3.00)

Plexiglass windows (#3671) and mail slots (#3669) may not be ordered for units serviced by the U.S.P.S.

- Custom finish (#3666 - add 10% to unit price)
- Custom engraved placards (#3667 - \$3.00)
- Custom engraved door - regular (door will be solid - no card holder) (#3668 - \$3.00)
- Custom engraved door - black filled (door will be solid - no card holder) (#3674 - \$3.00)
- Custom engraving on collection unit - regular (#3665 - \$20.00)
- Custom engraving on collection unit - black filled (#3670 - \$20.00)
- Self-adhesive numbers - sheets of (100) (#3695 - \$15.00)
- 4B+ Master door security retrofit kit (#3696 - \$50.00)

123

#3667
Engraved placard

123

#3668
Engraved door - regular

123

#3674
Engraved door - black filled



Custom horizontal mailbox with combination locks (#3686) and custom regular engraved doors (#3668) in bronze finish displayed.

DOOR AND COMPARTMENT IDENTIFICATION

Each mailbox door includes a 2" W x 5/8" H clear plastic card holder (#3697 - \$3.00) to identify the tenant's name and/or box number. Self-adhesive numbers (1-3000 available) are supplied upon request with each order. Custom identification systems are available as an option upon request. Label holders (#1070 - \$30.00 - page 61) neatly organize and identify the front/rear of the mailbox compartments and are available as an option upon request.

LOCKS

- Each mailbox door includes a five (5) pin cylinder cam lock with two (2) keys (1,000 different key changes). (#3690 - \$8.00)
- Additional keys per lock when ordering (#3698 - \$2.00)
- Custom lock installation - cylinders provided by owner - (100) door minimum (#3693 - \$4.00 additional per door)
- For installations not serviced by the U.S.P.S.
 - Three (3) digit single dial combination lock with spring latch and automatic throw-off (combination numbers can be changed by owner) (#3686 - \$10.00)
 - Thumb latch (in lieu of standard lock) (#3689 - \$3.00)
 - Resetttable combination lock (#3682 - \$30.00)
 - Master control key - for #3682 resetttable combination lock (#3683 - \$3.00)
- Key blanks - box of (50) - for 3600 series (#3699 - \$30.00)

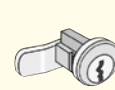

#3690
Lock for 3600 series
\$8.00

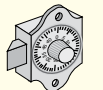

#3686
Combination lock
\$10.00

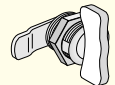

#3689
Thumb latch
\$3.00



#3682
Resetttable Combination lock
\$30.00

Vertical Mailboxes



3503



3504



3505



#3507 aluminum recessed units with optional custom engraved placards (#3567) displayed



VERTICAL MAILBOXES FRONT LOADING



Made entirely of aluminum, Salsbury 3500 series U.S.P.S. approved vertical mailboxes are available in surface mounted and recessed mounted units. The mailboxes feature 5-1/2" W x 16-1/4" H extruded aluminum doors and a durable powder coated finish available in five (5) contemporary colors. Each mailbox door includes a five (5) pin cylinder cam lock with two (2) keys and a 2-1/2" W x 5/8" H indentation to accommodate a label (included) to identify the tenant's name and/or box number. Mailboxes are available in units with three (3) to seven (7) compartments. Each compartment is 6-3/4" deep. Vertical mailboxes are ideal for apartments, condominiums, commercial buildings and many other applications.

5-1/2"
16-1/4"
**3500 SERIES
DOOR SIZE**
#3551¹
Replacement
door and
lock
\$25.00

VERTICAL MAILBOX OPTIONS

OPTIONS

- Outgoing mail slot - in the far left door of the unit unless otherwise specified (#3569 - \$10.00)
- Master commercial lock - factory installed if for private access - with (2) keys (#3575 - \$25.00)
- 4B+ Master door security retrofit kit (#3596 - \$50.00)

DOOR IDENTIFICATION

Each mailbox door includes a 2-1/2" W x 5/8" H indentation to accommodate a label (included) to identify the tenant's name and/or box number. Custom identification systems are available as an option upon request.

LOCKS

- Each mailbox door includes a five (5) pin cylinder cam lock with (2) keys (1,000 different key changes). (#3590 - \$8.00)
- Additional keys per lock when ordering (#3598 - \$2.00)
- Key blanks - box of (50) (#3599 - \$30.00)

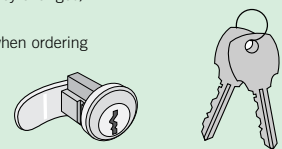

#3590
Lock for 3500 series
\$8.00

#3598
Additional keys for #3590
\$2.00 per key

Note: 3500 series 4B+ vertical mailboxes have been U.S.P.S. approved to the required security upgrades of USPS-STD-4B+. These mailboxes are approved for replacement and/or retrofit installations. For new construction and major renovations, see 4C horizontal mailboxes on pages 12-17.



3506



3507

LETTER BOXES USPS or PRIVATE access

A letter box is an ideal way to collect outgoing mail or other correspondence. See pages 46-47 for additional products and specifications. \$125.00

CUSTOM ENGRAVING (OPTION - #2266)

Custom engraving for letter boxes (specify regular or black filled) is available as an option upon request. See page 46 for specifications. \$20.00

OUTGOING MAIL SLOT (OPTION - #3569)

A 4-3/8" W x 1/2" H outgoing mail slot is available as an option upon request. It will be located in the far left door of the unit unless otherwise specified. If a mail slot is requested, order unit with one additional compartment than the total number of tenants receiving mail. \$10.00

CUSTOM ENGRAVED PLACARDS (OPTION - #3567)

2-1/2" W x 5/8" H custom engraved self-adhesive placards are available as an option upon request. \$3.00



2240

SAMPLE INSTALLATION

Model displayed:
(2) 3503's

Recessed mounted units fit into a rough opening and are secured with mounting hardware through the back or side panels. Recessed units feature a fully integrated flanged collar which fits over the rough opening.

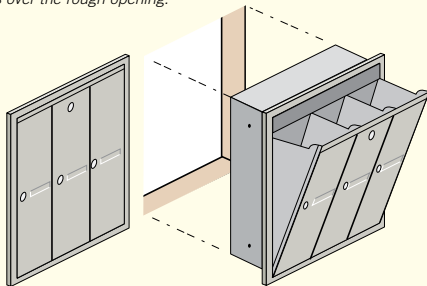

Note: For U.S.P.S. accessed vertical mailboxes, the master lock in the top tier of mailboxes must be no more than 58" above the finished floor. The master lock in the bottom tier of mailboxes must be no less than 30" above the finished floor. No more than two (2) tiers of mailboxes may be installed.

Note: Rough opening for recessed mounted vertical mailboxes is 1-1/2" less than the unit's width, 1-1/4" less than the unit's height and equal to the unit's depth.

Note: Rough opening for recessed letter boxes (#2245) is 13-3/4" W x 17-3/4" H x 6-3/4" D.

VERTICAL MAILBOXES - FRONT LOADING - U.S.P.S. APPROVED

MODEL	DESCRIPTION	UNIT SIZE	WEIGHT	PRICE
3503 ^{1,2,3}	3 Doors	18-3/4" W x 19" H x 7-1/2" D	25 lbs.	\$90.00
3504 ^{1,2,3}	4 Doors	24-1/4" W x 19" H x 7-1/2" D	30 lbs.	\$120.00
3505 ^{1,2,3}	5 Doors	29-3/4" W x 19" H x 7-1/2" D	35 lbs.	\$150.00
3506 ^{1,2,3}	6 Doors	35-1/4" W x 19" H x 7-1/2" D	40 lbs.	\$180.00
3507 ^{1,2,3}	7 Doors	40-3/4" W x 19" H x 7-1/2" D	45 lbs.	\$210.00
3575	Master commercial lock - factory installed if for private access - with (2) keys			\$25.00
3590	Lock - standard replacement for 3500 series doors - with (2) keys			\$8.00
3599	Key blanks - for standard 3500 series locks - box of (50)			\$30.00
2240 ^{1,4}	Letter Box - surface	15" W x 19" H x 7-1/2" D	20 lbs.	\$125.00
2245 ^{1,4}	Letter Box - recessed	15" W x 19" H x 6-3/4" D	20 lbs.	\$125.00
2246	Master commercial lock - factory installed if for private access - with (2) keys			\$25.00

¹ Specify



aluminum



brass



bronze



sandstone



green

² Specify - surface mounted or recessed mounted

³ Specify - U.S.P.S. access or private access (order master commercial lock #3575)

⁴ Specify - U.S.P.S. access or private access (order master commercial lock #2246)

Aluminum Mailboxes - Standard System



2230



2220



2218

STANDARD SYSTEM REAR LOADING



Salsbury 2200 series standard system aluminum mailboxes have 1/4" thick extruded aluminum doors with a durable powder coated aluminum finish. Each door includes a five (5) pin cylinder cam lock with two (2) keys. Standard system aluminum mailbox units are designed to stack two (2) high and mount adjacent to each other or between wall studs. All units have the same outside dimensions. Alternative locking systems are available - see aluminum mailbox options on page 39. The mailbox compartments have open backs (hinged locking rear covers #2250 are available as an option upon request) and are constructed of 20 gauge steel. Standard system aluminum mailboxes are ideal for use in colleges and schools, private postal centers, government agencies, corporate mailrooms, military bases, police stations and many other applications.

STANDARD SYSTEM - REAR LOADING

MODEL	DESCRIPTION	DOOR SIZE	WEIGHT	PRICE
2230	30 Doors	3-1/2" W x 5-1/2" H	100 lbs.	\$525.00
2220	20 Doors	5-1/2" W x 5-1/2" H	90 lbs.	\$500.00
2218	18 Doors	(16) 5-1/2" W x 5-1/2" H (2) 10-3/4" W x 5-1/2" H	90 lbs.	\$500.00
2214	14 Doors	(12) 5-1/2" W x 5-1/2" H (2) 10-3/4" W x 11-1/2" H	85 lbs.	\$500.00
2210	10 Doors	10-3/4" W x 5-1/2" H	85 lbs.	\$500.00
2206	6 Doors	(2) 10-3/4" W x 5-1/2" H (4) 10-3/4" W x 11-1/2" H	70 lbs.	\$450.00
UNIT SIZE		23-1/2" W x 30" H x 15-1/2" D		
2213	Trim - black - for up to (3) columns of mailboxes			\$80.00
2286	Lock - combination for each 2200 series door			\$10.00
2290	Lock - standard replacement for 2200 series doors - with (2) keys			\$8.00
2299	Key blanks - for standard 2200 series locks - box of (50)			\$30.00

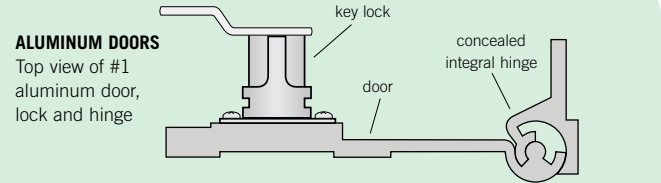

2200 SERIES STANDARD SYSTEM DOOR SIZES

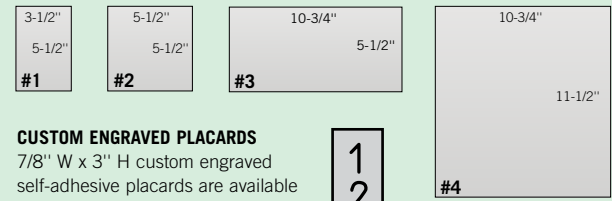

CUSTOM ENGRAVED PLACARDS
7/8" W x 3" H custom engraved self-adhesive placards are available as an option upon request. (#2267 - \$3.00)

CUSTOM DOOR ENGRAVING
Custom door engraving is available as an option upon request.

- Custom engraved door - regular (#2268 - \$3.00)
- Custom engraved door - black filled (#2274 - \$3.00)

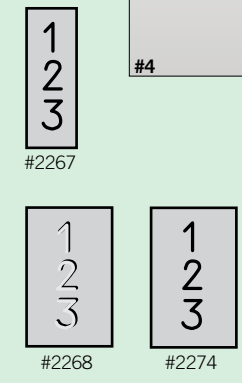

SAMPLE INSTALLATION

Models displayed:
(3) 2230's
(3) 2218's

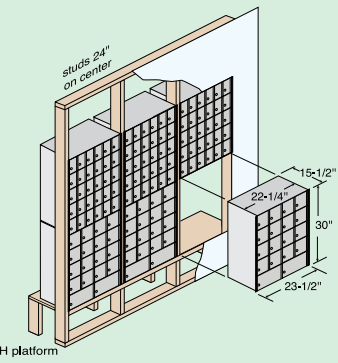

Allow approximately 24" W and 60" H for each mailbox column.



2214



2210



2206

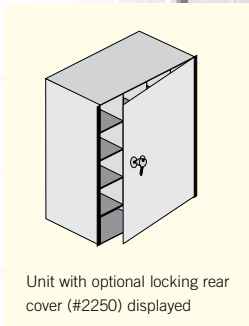

Unit with optional locking rear cover (#2250) displayed



Standard system aluminum mailboxes (#2230) with optional combination locks (#2286) and custom engraved placards (#2267) displayed

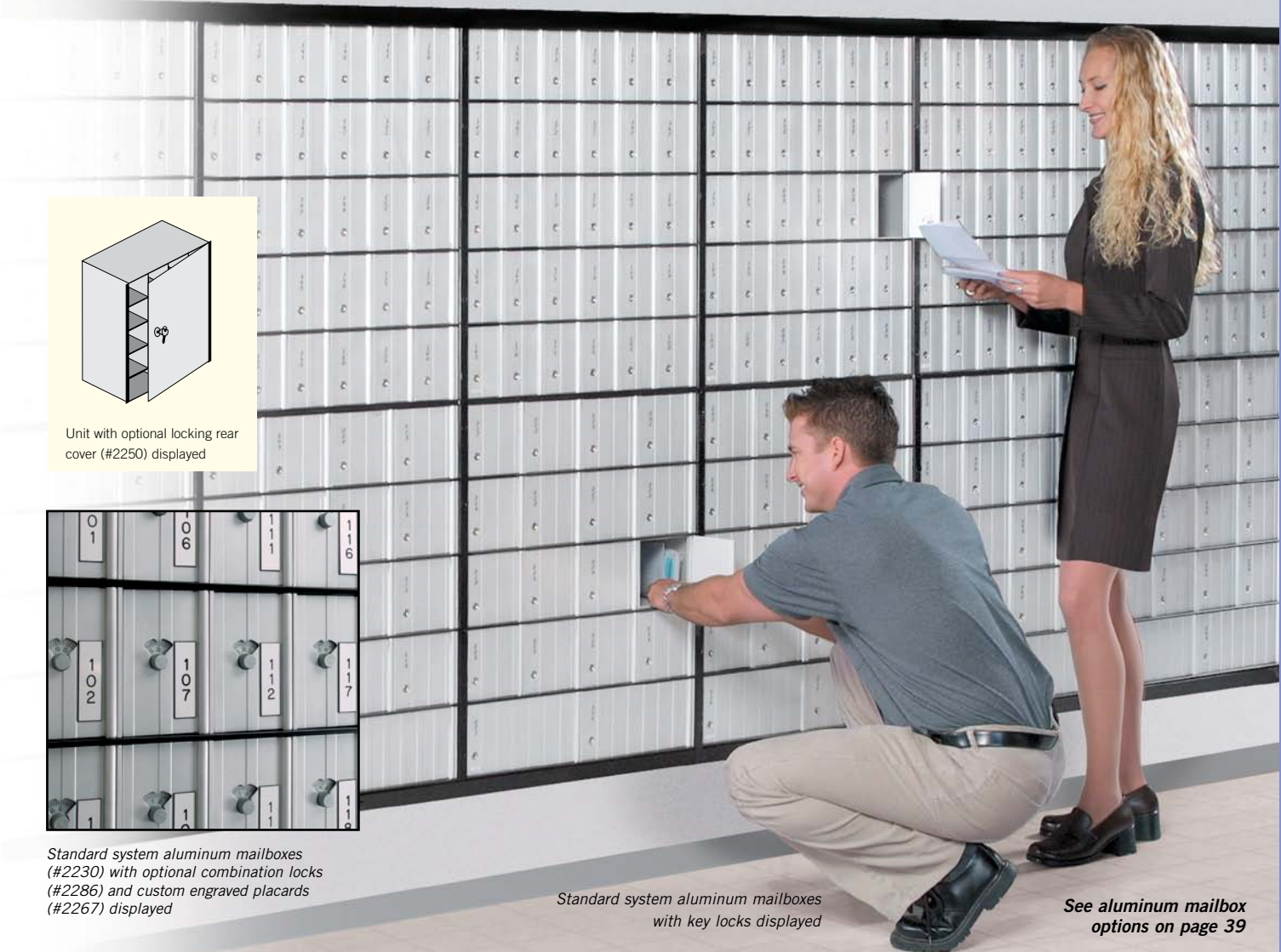

Standard system aluminum mailboxes with key locks displayed

See aluminum mailbox options on page 39

Aluminum Mailboxes - Rack Ladder System

RACK LADDER SYSTEM - REAR LOADING



Salsbury 2200 series rack ladder system aluminum mailboxes have 1/4" thick extruded aluminum doors with a durable powder coated aluminum finish. Each door includes a five (5) pin cylinder cam lock with two (2) keys. The mailbox compartments have open backs (rear covers for a column of rack ladder mailboxes #2251 and for individual rack ladder mailboxes #2252 are available as options upon request) and are constructed of 20 gauge steel. All units have the same outside dimensions. Rack ladder system aluminum mailbox units are designed to be installed between rack ladders (#2200). The rack ladders support five (5) mailbox units to form a column of mailboxes. These units can be accessed by the U.S.P.S. when used in Rotary Mail Centers (see page 44).



2212



2208

PARCEL LOCKERS



Salsbury 2200 series parcel lockers offer tenants a convenient way to receive packages on site and are fit with a two (2) key security system. When the U.S.P.S. or an individual delivers a parcel to the locker, a parcel locker key is placed in the recipient's mailbox. Once the recipient opens the parcel locker, the key is automatically retained in the lock until it is removed with a control key. The units have 1/4" thick extruded aluminum doors with a durable powder coated aluminum finish and are equipped with a hinged rear door which allows access from the rear. Parcel lockers are designed to fit into the rack ladder and data distribution systems (see pages 38-39) and Free-Standing Mail Centers (see pages 44-45).

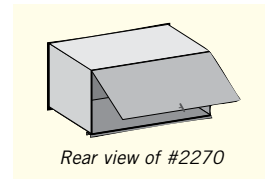

Rear view of #2270



2270



2272

DROP BOXES



Salsbury 2200 series drop boxes have a 1/4" thick extruded aluminum solid front with a durable powder coated aluminum finish. The one compartment drop box (#2280) has a 16" W x 3/4" H mail slot. The two (2) compartment drop box (#2282) has two (2) 9" W x 3/4" H mail slots. Drop boxes have a 4" high rear panel to contain the mail. Individual locking rear covers (#2285) are available as an option upon request. Drop boxes are designed to fit into the rack ladder and data distribution systems (see pages 38-39) and Free-Standing Mail Centers (see pages 44-45).

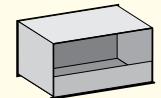

Rear view of #2280



Rear view of #2280 with optional hinged locking rear cover #2285



2280



2282



Parcel lockers and drop boxes with custom engraved placards (#2267) displayed



2204



2202



2201

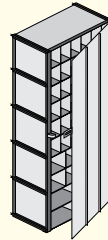

Column of rack ladder mailboxes with optional hinged rear cover (#2251) displayed

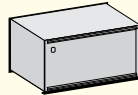

Individual rack ladder mailbox with optional locking rear cover (#2252) displayed

RACK LADDER SYSTEM - REAR LOADING

MODEL	DESCRIPTION	DOOR SIZE	WEIGHT	PRICE
2212	12 Doors	3-1/2" W x 5-1/2" H	45 lbs.	\$160.00
2208	8 Doors	5-1/2" W x 5-1/2" H	40 lbs.	\$150.00
2204	4 Doors	10-3/4" W x 5-1/2" H	35 lbs.	\$140.00
2202	2 Doors	10-3/4" W x 11-1/2" H	35 lbs.	\$130.00
2201	1 Door	22" W x 11-1/2" H	35 lbs.	\$120.00
UNIT SIZE		23-1/4" W x 12-1/8" H x 15-1/2" D		
2286	Lock - combination for each 2200 series door			\$10.00
2290	Lock - standard replacement for 2200 series doors - with (2) keys			\$8.00
2299	Keys blanks - for standard 2200 series locks - box of (50)			\$30.00
2270	¹ Parcel Locker - (1) door 22" W x 11-1/2" H		35 lbs.	\$175.00
2272	¹ Parcel Locker - (2) doors 10-3/4" W x 11-1/2" H		35 lbs.	\$225.00
2275	Master commercial lock - for 2270 and 2272 - with (2) keys			\$25.00
2276	Lock - tenant lock assembly for 2270 and 2272 - with (2) keys			\$35.00
2280	Drop Box - (1) compartment 23" W x 12" H		35 lbs.	\$150.00
2282	Drop Box - (2) compartments 11" W x 12" H		35 lbs.	\$175.00
2285	Rear cover - locking - option for 2280 and 2282		5 lbs.	\$35.00
2200	Rack Ladder 61-7/8" H x 15-1/2" D		25 lbs.	\$70.00
2200C	Rack Ladder - custom - specify 2, 3, 4 or 6 high			\$90.00
2213	Trim - black - for up to (3) columns of mailboxes			\$80.00

¹ Specify - U.S.P.S. access or private access (order master commercial lock #2275)

ALUMINUM DOORS

Top view of #1 aluminum door, lock and hinge

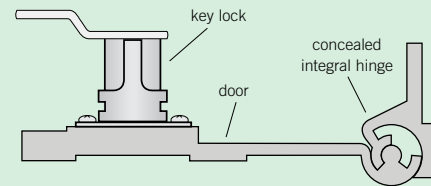

2200 SERIES RACK LADDER SYSTEM DOOR SIZES

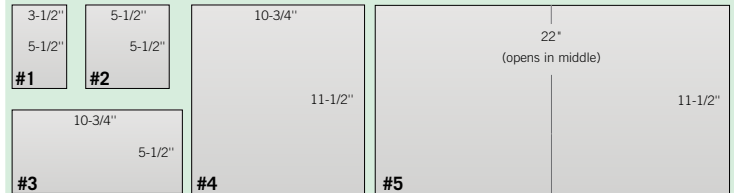

CUSTOM ENGRAVED PLACARDS

7/8" W x 3" H custom engraved self-adhesive placards are available as an option upon request. (#2267 - \$3.00)

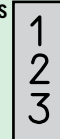

#2267

CUSTOM DOOR ENGRAVING

Custom door engraving is available as an option upon request.

- Custom engraved door - regular (#2268 - \$3.00)
- Custom engraved door - black filled (#2274 - \$3.00)

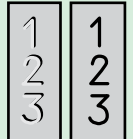

#2268 #2274

SAMPLE INSTALLATION

Models displayed:

- (9) 2212's
- (3) 2208's
- (3) 2204's
- (4) 2200's

Units are secured from the rear by brackets (not pictured).

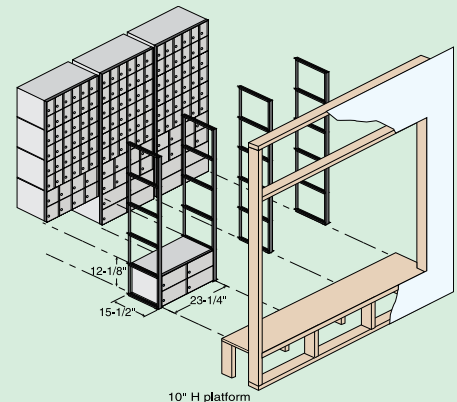

Allow approximately 24" W and 62" H for each mailbox column.

One column of mailbox units requires two (2) rack ladders and each additional column in the same configuration requires one additional rack ladder.

See aluminum mailbox options on page 39

Aluminum Boxes - Data Distribution System

DATA DISTRIBUTION SYSTEM PRIVATE ACCESS

Salsbury 2400 series data distribution system aluminum boxes have 1/4" thick extruded aluminum doors with a durable powder coated aluminum finish. Each door includes a 3/4" high door slot, a five (5) pin cylinder cam lock with two (2) keys and is hinged horizontally at the bottom. Alternative locking systems are available - see aluminum mailbox options on page 39. Doors are available without slots upon request. The compartments have open backs (rear covers for a column of data distribution boxes #2451 and rear covers for individual data distribution boxes #2452 are available as options upon request) and are constructed of 20 gauge steel. All units have the same outside dimensions. Data distribution system boxes are designed to be installed between rack ladders (#2400). The rack ladders support five (5) units to form a column of boxes. Data distribution system boxes can also be used in Free-Standing Mail Centers (see pages 44-45).



2406



Data distribution doors are available without slots as an option upon request and can accommodate combination locks #2486 (combination locks are not available on doors with slots or on model #2401).

DATA DISTRIBUTION SYSTEM

MODEL	DESC.	DOOR SIZE	WEIGHT	PRICE
2406	6 Doors	11" W x 3-1/2" H slots 9" W x 3/4" H	40 lbs.	\$220.00
2404	4 Doors	11" W x 5-1/2" H slots 9" W x 3/4" H	35 lbs.	\$200.00
2402	2 Doors	22" W x 5-1/2" H slots 20" W x 3/4" H	35 lbs.	\$190.00
2401	1 Door	22" W x 11-1/2" H slot 20" W x 3/4" H	35 lbs.	\$180.00
UNIT SIZE		23-1/4" W x 12-1/8" H x 15-1/2" D		
2400	Rack Ladder	61-7/8" H x 15-1/2" D	25 lbs.	\$70.00
2400C	Rack Ladder - custom - specify 2, 3, 4 or 6 high			\$90.00
2413	Trim - black - for up to (3) columns of data distribution boxes			\$80.00
2486	Lock - combination for each 2400 series door (on units w/out slots only)			\$10.00
2490	Lock - standard replacement for 2400 series doors - with (2) keys			\$8.00
2499	Key blanks - for standard 2400 series lock - box of (50)			\$30.00

Data distribution system aluminum boxes with custom engraved placards (#2467) displayed



2404



2402



2401

2400 SERIES DATA DISTRIBUTION SYSTEM DOOR SIZES

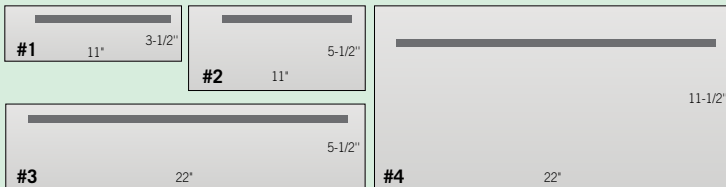

CUSTOM ENGRAVED PLACARDS

3" W x 7/8" H custom engraved self-adhesive placards are available as an option upon request. (#2467 - \$3.00)

CUSTOM DOOR ENGRAVING

Custom door engraving is available as an option upon request.

- Custom engraved door - regular (#2468 - \$3.00)
- Custom engraved door - black filled (#2474 - \$3.00)

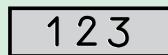

Engraved placard (#2467 - \$3.00)

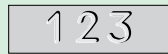

Engraved door - regular (#2468 - \$3.00)

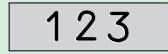

Engraved door - black filled (#2474 - \$3.00)

SAMPLE INSTALLATION

Models displayed:

- (6) 2406's
- (3) 2404's
- (3) 2402's
- (3) 2401's
- (4) 2400's

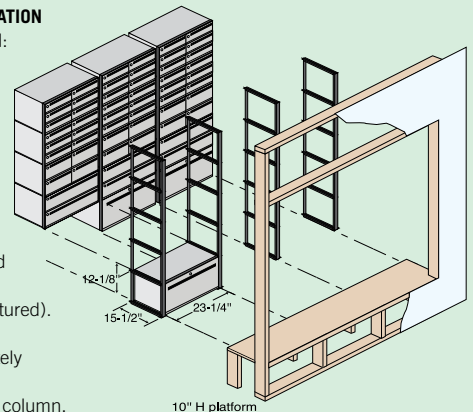

Units are secured from the rear by brackets (not pictured).

Allow approximately 24" W and 62" H for each mailbox column.

One column of data distribution boxes requires two (2) rack ladders and each additional column in the same configuration requires one additional rack ladder.

ALUMINUM MAILBOX OPTIONS - FOR STANDARD, RACK LADDER AND DATA DISTRIBUTION SYSTEMS (pages 34-39)

OPTIONS

- Custom sized units - call for pricing
- Custom rack ladders for varied column heights (specify 2, 3, 4 or 6 high columns) (#2200C / #2400C - \$90.00)
- Rear covers
 - locking on standard system mailboxes (#2250 - \$50.00)
 - hasp on rack ladder system columns (#2251 - \$100.00)
 - locking on individual rack ladder system mailboxes (#2252 - \$50.00)
 - hasp on data distribution system columns (#2451 - \$100.00)
 - locking on individual data distribution boxes (#2452 - \$50.00)
- Trim - black snap-on peripheral trim 1-1/2" W x 3/8" D for up to three (3) columns of mailboxes or data distribution boxes (#2213 / #2413 - \$80.00)
- Plexiglass window (#2271 - \$3.00)

- Mail slots (#2269 - \$3.00)

Standard mail slot sizes for 2200 series:

- #1 Door - 2-1/2" W x 3/4" H
- #2 Door - 4" W x 3/4" H
- #3 Door - 9" W x 3/4" H
- #4 Door - 9" W x 3/4" H
- #5 Door - 9" W x 3/4" H (on left side)



Custom slot sizes are available upon request.

- Custom door finish as specified (#2264 / #2464 add 10% to unit price)
- Engraved placards (#2267 / #2467 - \$3.00)
- Engraved door - regular (#2268 / #2468 - \$3.00)
- Engraved door - black filled (#2274 / #2474 - \$3.00)
- Self-adhesive numbers - sheets of (100) (#2295 / #2495 - \$15.00)
- Label holders - (50) 3" W x 3/8" H (#1070 - \$30.00)



#2268 Sample door engraving - regular \$3.00

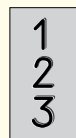

#2274 Sample door engraving - black filled \$3.00

#2213 / #2413 Trim \$80.00



#2271 Plexiglass window 7/8" W x 1-1/4" H \$3.00



DOOR AND COMPARTMENT IDENTIFICATION

Self-adhesive numbers (1-3000 available) are supplied upon request with a standard order. Custom identification systems are available as an option upon request. Label holders (#1070 - \$30.00) neatly organize and identify the rear of the mailbox compartments and are available as an option upon request.

LOCKS

- Each mailbox and data distribution door includes a five (5) pin cylinder cam lock with two (2) keys (1,000 different key changes).
 - Lock - for 2200 and 2400 series (#2290 / #2490 - \$8.00)
 - Three (3) digit single dial combination lock with spring latch and automatic throw-off (#2286 / #2486 - \$10.00) (combination numbers can be changed by owner)
 - Thumb latch - in lieu of standard lock (#2289 / #2489 - \$3.00)
 - Spring latch lock with two (2) keys - not pictured (#2287 - \$10.00)
 - Custom lock installation - cylinders provided by owner - (100) door minimum (#2293 - \$4.00 additional per door)
 - Key blanks - box of (50) - for 2200 series (#2299 - \$30.00)
 - Key blanks - box of (50) - for 2400 series (#2499 - \$30.00)

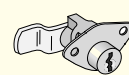

#2290 Lock for 2200 series \$8.00



#2490 Lock for 2400 series \$8.00

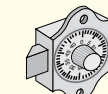

#2286 / #2486 Combination lock \$10.00

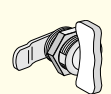

#2289 / #2489 Thumb latch \$3.00

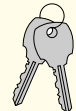

#2298 / #2498 Additional keys for #2290 and #2490 \$2.00 per key

Brass Mailboxes



2030RL



2016RL



2014RL



BRASS MAILBOXES PRIVATE access R REAR OR FRONT LOADING

Salsbury 2000 series brass mailboxes have solid brass die-cast doors. Each door includes a five (5) pin cylinder cam lock with two (2) keys, a clear 1/4" thick glass window and a name plate to identify the tenant's name and/or box number. The doors are hinged on brass frames and are attached to the individual compartments with four (4) screws. The mailbox compartments are constructed of 20 gauge steel and powder coated tan. They are designed to stack two (2) high and mount adjacent to each other or between wall studs. All units have the same outside dimensions. Rear loading units can be accessed by the U.S.P.S. when used in Rotary Mail Centers (see page 44).

If Rear Loading:

Units have open backs. Hinged locking rear covers (#2050) are available as an option upon request.

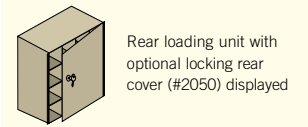

If Front Loading:

Units include solid rear covers. Two (2) master commercial locks with two (2) keys (#2092) open a door panel that swings on a continuous hinge. All openings are usable.

2000 SERIES DOOR SIZES AND SPARE PARTS

Solid brass replacement doors include frame and lock with two (2) keys.

3-1/2"
5"
#1

#2051
\$25.00

5-1/2"
6"
#2

#2052
\$35.00

11"
6"
#3

#2053
\$45.00

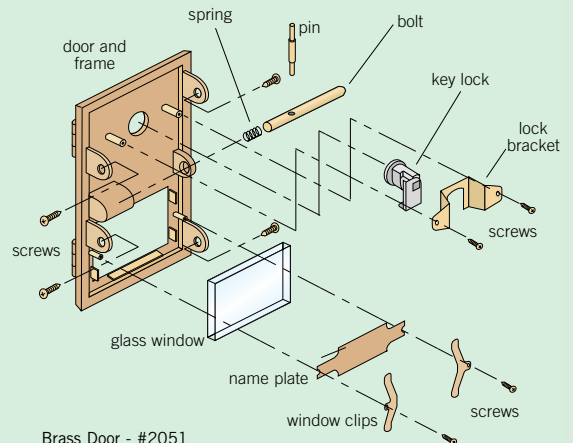

Brass Door - #2051
Rear view of #1 brass door



2008RL



Sample Front Loading (FL) Unit

SAMPLE INSTALLATION

Models displayed:
(3) 2030RL's
(3) 2014RL's

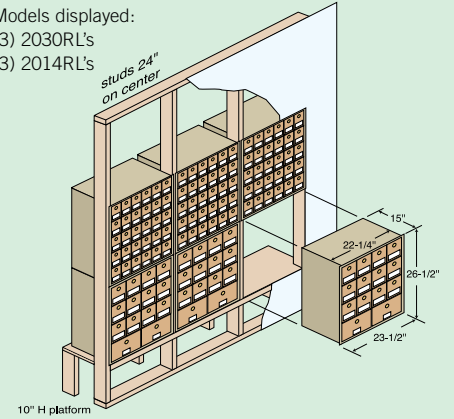

Allow approximately 24" W and 53" H for each mailbox column.



BRASS MAILBOXES - REAR OR FRONT LOADING

MODEL	DESCRIPTION	DOOR SIZE	WEIGHT	PRICE
REAR LOADING				
2030RL	30 Doors	3-1/2" W x 5" H	105 lbs.	\$580.00
2016RL	16 Doors	5-1/2" W x 6" H	90 lbs.	\$540.00
2014RL	14 Doors	(12) 5-1/2" W x 6" H (2) 11" W x 6" H	90 lbs.	\$540.00
2008RL	8 Doors	11" W x 6" H	90 lbs.	\$540.00
UNIT SIZE 23-1/2" W x 26-1/2" H x 15" D				
FRONT LOADING				
2030FL	30 Doors	3-1/2" W x 5" H	115 lbs.	\$680.00
2016FL	16 Doors	5-1/2" W x 6" H	100 lbs.	\$640.00
2014FL	14 Doors	(12) 5-1/2" W x 6" H (2) 11" W x 6" H	100 lbs.	\$640.00
2008FL	8 Doors	11" W x 6" H	100 lbs.	\$640.00
UNIT SIZE 23-1/2" W x 26-1/2" H x 16" D				
2013	Trim - tan - for up to (3) columns of mailboxes			\$80.00
2086	Lock - combination for each 2000 series door			\$10.00
2090	Lock - standard replacement for 2000 series doors - with (2) keys			\$8.00
2099	Key blanks - for standard 2000 series locks - box of (50)			\$30.00

BRASS MAILBOX OPTIONS

OPTIONS

- Custom sized mailbox units - call for pricing
- Plastic windows - specify clear or tan
#1 and #3 door size #2 door size
(#2071 - \$1.75) (#2073 - \$2.00)
- Rear covers - locking on rear loading units
(#2050 - \$50.00)
- Trim - tan snap-on peripheral trim
1-1/2" W x 3/8" D for up to (3) columns of mailboxes
(#2013 - \$80.00)

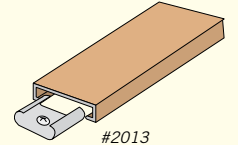

DOOR AND COMPARTMENT IDENTIFICATION

Each mailbox door is equipped to identify the tenant's name and/or box number. Self-adhesive numbers (1-3000 available) are supplied upon request with a standard order. Custom identification systems are available as an option upon request. Label holders neatly organize and identify the front/rear of the mailbox compartments and are available as an option upon request.

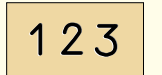

#2068 Window engraving (for clear or tan plastic windows only) \$3.00

BOX 123

#1070 Label holders (50) \$30.00

- Custom window engraving - specify on clear or tan plastic window
(#2068 - \$3.00)
- Self-adhesive numbers - sheets of (100)
(#2095 - \$15.00)
- Label holders - (50) 3" W x 3/8" H
(#1070 - \$30.00)

LOCKS

Each mailbox door includes a five (5) pin cylinder cam lock with two (2) keys (1,000 different key changes).

- Lock - for 2000 series
(#2090 - \$8.00)
- Three (3) digit single dial combination lock with spring latch and automatic throw-off (combination numbers can be changed by owner) Not available on #3 doors
(#2086 - \$10.00)
- Thumb latch - in lieu of standard lock
(#2089 - \$3.00)
- Lock - front loading master
(#2092 - \$10.00) not pictured
- Additional keys per lock (#2090) when ordering
(#2098 - \$2.00)
- Key blanks - box of (50) - for 2000 series
(#2099 - \$30.00)

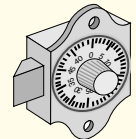

#2086 Combination lock for 2000 series (n/a on #3 doors) \$10.00



#2090 Lock for 2000 series \$8.00

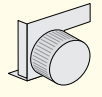

#2089 Thumb latch for 2000 series \$3.00

Americana Mailboxes

AMERICANA MAILBOXES REAR OR FRONT LOADING



Salsbury 2100 series Americana mailboxes have aluminum die-cast doors. Each door includes a five (5) pin cylinder cam lock with two (2) keys. The doors are hinged on aluminum die-cast frames and are attached to the individual compartments with four (4) screws. The mailbox compartments are constructed of 20 gauge steel and powder coated tan. They are designed to stack two (2) high and mount adjacent to each other or between wall studs. All units have the same outside dimensions. Rear loading units can be accessed by the U.S.P.S. when use in Rotary Mail Centers (see page 44). Americana mailboxes are ideal for use in colleges and schools, private postal centers, government agencies, corporate mailrooms, military bases and many other applications.

If Rear Loading:

Units have open backs. Hinged locking rear covers (#2150) are available as an option upon request.

If Front Loading:

Units include solid rear covers. Two (2) master commercial locks with two (2) keys (#2192) open a door panel that swings on a continuous hinge. All openings are usable.



2100 SERIES DOOR SIZES

Replacement doors include frame and lock with two (2) keys.

3-1/2" 5" #1	5-1/2" 6" #2	11" 6" #3
#2151 \$20.00	#2152 \$30.00	#2153 \$40.00



2130RL



2116RL

AMERICANA MAILBOXES - REAR OR FRONT LOADING

MODEL	DESCRIPTION	DOOR SIZE	WEIGHT	PRICE
REAR LOADING				
2130RL	30 Doors	3-1/2" W x 5" H	85 lbs.	\$525.00
2116RL	16 Doors	5-1/2" W x 6" H	70 lbs.	\$475.00
2114RL	14 Doors	(12) 5-1/2" W x 6" H (2) 11" W x 6" H	70 lbs.	\$475.00
2108RL	8 Doors	11" W x 6" H	70 lbs.	\$475.00
UNIT SIZE		23-1/2" W x 26-1/2" H x 15" D		
FRONT LOADING				
2130FL	30 Doors	3-1/2" W x 5" H	95 lbs.	\$625.00
2116FL	16 Doors	5-1/2" W x 6" H	80 lbs.	\$575.00
2114FL	14 Doors	(12) 5-1/2" W x 6" H (2) 11" W x 6" H	80 lbs.	\$575.00
2108FL	8 Doors	11" W x 6" H	80 lbs.	\$575.00
UNIT SIZE		23-1/2" W x 26-1/2" H x 16" D		
2113	Trim - tan - for up to (3) columns of mailboxes			\$80.00
2190	Lock - standard replacement for 2100 series doors - with (2) keys			\$8.00
2199	Key blanks - for standard 2100 series locks - box of (50)			\$30.00

SAMPLE INSTALLATION

Models displayed:
 (3) 2130RL's
 (3) 2114RL's

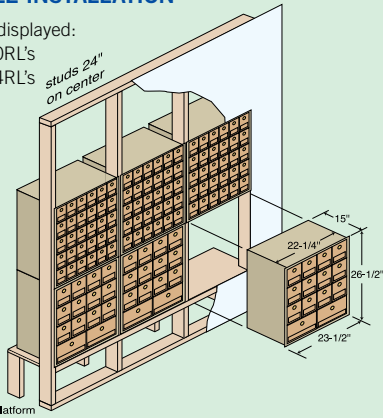

Allow approximately 24" W and 53" H for each mailbox column.

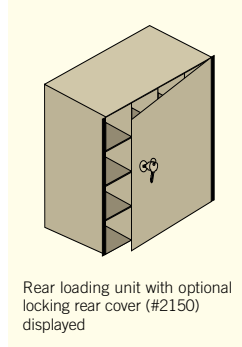

Rear loading unit with optional locking rear cover (#2150) displayed



2114RL



2108RL



Sample Front Loading (FL) Unit

AMERICANA MAILBOX OPTIONS

OPTIONS

- Custom sized mailbox units - call for pricing
- Rear covers - locking on rear loading units (#2150 - \$50.00)
- Trim - tan snap-on peripheral trim 1-1/2" W x 3/8" D for up to (3) columns of mailboxes (#2113 - \$80.00)

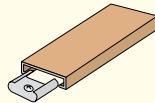

#2113 trim \$80.00

DOOR AND COMPARTMENT IDENTIFICATION

Each mailbox door is equipped to identify the tenant's name and/or box number. Self-adhesive numbers (1-3000 available) are supplied upon request with a standard order. Label holders (#1070 - \$30.00) neatly organize and identify the front/rear of the mailbox compartments and are available as an option upon request.

- Custom engraved tan placards (#2167 - \$3.00)
- Custom engraved door (#2168 - \$3.00)
- Label holders - (50) 3" W x 3/8" H (#1070 - \$30.00)
- Self adhesive numbers - sheets of (100) (#2195 - \$15.00)

#2167 Engraved placard \$3.00

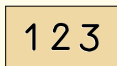

#2168 Engraved door \$3.00

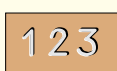

#1070 Label holders (50) \$30.00



LOCKS

Each mailbox door includes a five (5) pin cylinder cam lock with two (2) keys (1,000 different key changes).

- Lock - for 2100 series (#2190 - \$8.00)
- Thumb latch - in lieu of standard lock (#2189 - \$3.00)
- Lock - front loading master (#2192 - \$10.00)
- Additional keys per lock when ordering (#2198 - \$2.00)
- Key blanks - box of (50) - for 2100 series (#2199 - \$30.00)

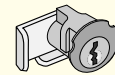

#2190 Lock for 2100 series \$8.00

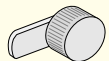

#2189 Thumb latch for 2100 series \$3.00



#2192 Front loading master lock \$10.00

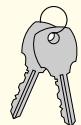

#2198 Additional keys for #2190 \$2.00 per key

Free-Standing Mail Centers

ROTARY MAIL CENTERS

Constructed of 16 gauge steel, heavy duty 3100 series Rotary Mail Centers feature a vinyl finish available in five (5) contemporary colors. Aluminum style Rotary Mail Centers (#3100) are designed to accommodate a combination of five (5) aluminum rack ladder system mailboxes and data distribution system boxes (see pages 36-39). Brass style Rotary Mail Centers (#3150) are designed to accommodate a combination of two (2) brass or Americana style rear loading mailbox units (see pages 40-43). To operate, the user unlocks the unit and rotates the inner cabinet 180 degrees so that the rear of the mailboxes are facing the front (see below). After distributing the mail, the inner cabinet is rotated back 180 degrees to the tenant access position. A matching rear cover (#3125) is available as an option upon request. Rotary Mail Centers are ideal in locations where a secure and professional mailbox system is desired.



Inner cabinet rotates 180 degrees for mail distribution



3100



3150

order mailboxes separately

ROTARY MAIL CENTER OPTIONS

OPTIONS

- Master commercial lock - if Rotary Mail Center is for private access - with (2) keys (#3175 - \$50.00)
- Rear cover - to enclose the rear of the Rotary Mail Center (#3125 - \$150.00)

Note: Keyed versions of aluminum rack ladder system mailboxes and brass or Americana rear loading mailboxes can be accessed by the U.S.P.S. when installed in Rotary Mail Centers. Data distribution system boxes with slots may not be serviced by the U.S.P.S. when installed in Rotary Mail Centers.

3100^{1,2} Rotary Mail Center - aluminum style
(for aluminum rack ladder mailboxes and data distribution boxes - order separately - see pages 36-39)

- 30" W x 74" H x 24" D
- 225 lbs. (without mailboxes)
- \$975.00

¹ Specify



slate



white



blue



oak



walnut

3150^{1,2} Rotary Mail Center - brass style
(for brass and Americana rear loading mailboxes - order separately - see pages 40-43)

- 30" W x 74" H x 24" D
- 225 lbs. (without mailboxes)
- \$975.00

² Specify

- For U.S.P.S. access
- For private access (order master commercial lock #3175)

ROLL-A-BOUTS PRIVATE ACCESS

Made of 18 gauge steel, Salsbury 2300 series Roll-A-Bouts include casters for mobility and are useful when space is limited as wall construction is not required. Roll-A-Bouts are rear loading and feature a durable powder coated finish. Aluminum style Roll-A-Bouts (#2300) are designed to accommodate a combination of five (5) aluminum rack ladder system mailboxes and data distribution system boxes (see pages 36-39) and are powder coated black. Brass style Roll-A-Bouts (#2350) are designed to accommodate a combination of two (2) brass or Americana style rear loading mailbox units (see pages 40-43) and are powder coated tan. Units include a large rear door and are locked by placing a standard padlock (order optional keyed padlock #2390 - \$10.00) through a steel hasp and are an excellent way to add a private postal center to an existing business.



2300

2350

order mailboxes separately

SAMPLE CONFIGURATIONS

Sample configurations for Rotary Mail Centers and Roll-A-Bouts - order mailboxes and data distribution boxes separately. Mix and match to meet specific requirements. Minor assembly required.

ALUMINUM MAILBOXES OR DATA DISTRIBUTION BOXES

Rotary Mail Center #3100 and Roll-A-Bout #2300 - choose any five (5) aluminum rack ladder system mailboxes and data distribution system boxes from pages 36-39.

2212	2208	2406
2212	2204	2406
2212	2202	2404
2212	2201	2402
2280 drop box	2270 parcel locker	2401

BRASS OR AMERICANA MAILBOXES

Rotary Mail Center #3150 and Roll-A-Bout #2350 - choose any two (2) brass or Americana style rear loading mailbox units from pages 40-43.

2030RL	2014RL	2130RL
2016RL	2008RL	2114RL

2300 Roll-A-Bout - aluminum style

(for aluminum rack ladder mailboxes and data distribution boxes - order separately - see pages 36-39)

- 25-1/2" W x 67" H x 16-1/2" D
- casters: left 3" diameter rigid right 3" diameter swivel
- 120 lbs. (without mailboxes)
- \$450.00

2350 Roll-A-Bout - brass style

(for brass and Americana rear loading mailboxes - order separately - see pages 40-43)

- 26" W x 62" H x 16" D
- casters: left 3" diameter rigid right 3" diameter swivel
- 110 lbs. (without mailboxes)
- \$450.00

Note: Rack ladders (#2200 and #2400) are not required on models #3100 and #2300.

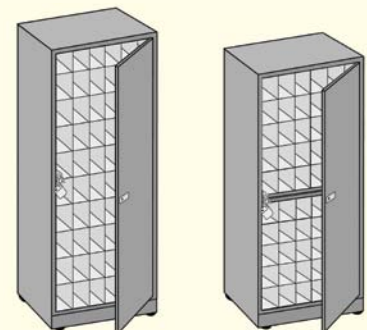

Rear view of #2300

Rear view of #2350

Letter Boxes

LETTER BOXES USPS or PRIVATE access

Made of sheet and extruded aluminum, Salsbury letter boxes are available in a standard size (#2240 and #2245) and a slim size (#2260 and #2265). Both sizes are available as surface mounted or recessed mounted units. Standard and slim letter boxes feature a durable powder coated finish available in five (5) contemporary colors. The doors are constructed of heavy duty 1/4" thick aluminum and are accessed from the front. Custom engraving (#2266) and plexiglass windows (#2273) are available as options upon request. Standard letter boxes are ideal for apartments, condominiums, commercial buildings, offices and many other applications.



#2240 surface mounted unit in aluminum finish displayed

MAIL SLOT (STANDARD)

Standard letter boxes feature an 11-1/2" W x 3/4" H mail slot. Slim letter boxes feature a 7-1/2" W x 3/4" H mail slot. Doors are available without slots as an option upon request.

CUSTOM SLOT (OPTION - #2249)

Slot sizes as specified can be customized to meet your requirements. \$20.00

CUSTOM ENGRAVING (OPTION - #2266)

Custom engraving (specify regular or black filled) is available as an option upon request. Examples are: OUTGOING MAIL, MAIL, U.S. MAIL, PAYMENTS, LETTERS, KEYS, SUGGESTION BOX, OFFICE, RENT DROP or as specified. \$20.00

PLEXIGLASS WINDOW (OPTION - #2273)

A 2" W x 10" H plexiglass window is available as an option upon request. This option should not be ordered for units serviced by the U.S.P.S. \$25.00

COMMERCIAL LOCK (OPTION - #2246)

A private access commercial lock with two (2) keys is available as an option for #2240 and #2245 upon request. \$25.00

THUMB LATCH (OPTION - #2288)

A non-locking thumb latch is available as an option upon request. \$10.00



custom
Numbers / Letters see page 101





2240 Letter Box - standard - surface mounted

- 15" W x 19" H x 7-1/2" D
- mail slot: 11-1/2" W x 3/4" H
- 20 lbs.
- \$125.00

2260¹ Letter Box - slim - surface mounted

- 11" W x 19" H x 3-3/4" D
- mail slot: 7-1/2" W x 3/4" H
- 15 lbs.
- \$100.00

Specify



2245 Letter Box - standard - recessed mounted

- 15" W x 19" H x 6-3/4" D
- mail slot: 11-1/2" W x 3/4" H
- rough opening:
13-3/4" W x 17-3/4" H x 6-3/4" D
- 20 lbs.
- \$125.00

2265¹ Letter Box - slim - recessed mounted

- 11" W x 19" H x 3-1/2" D
- mail slot: 7-1/2" W x 3/4" H
- rough opening:
9-1/2" W x 17-3/4" H x 3-1/2" D
- 15 lbs.
- \$100.00

- Specify
- For U.S.P.S. access
 - For private access
(order commercial lock #2246 for #2240 and #2245)

¹ Note: #2260 and #2265 are available in private access only and include commercial lock #2246.

SAMPLE INSTALLATION

Models displayed:

- (1) 2240
- (1) 2245

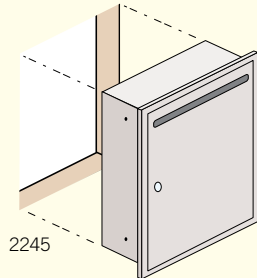
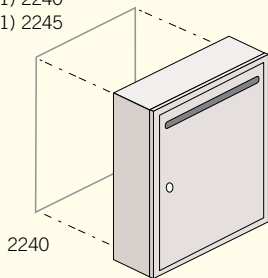

SURFACE MOUNTED

Surface mounted units mount directly to a flat surface and are secured with mounting hardware (not included) through the back panel.

RECESSED MOUNTED

Recessed mounted units fit into a rough opening and are secured with mounting hardware (not included) through the back or side panels. A fully integrated flanged collar fits over the rough panel.

Note: Sample installation also applies to #2260 and #2265



Recessed letter box (#2245) and (2) mail drops (#2255 - see pages 48-49) with optional custom engraving - black filled (#2266) displayed

Mail Drops / Receptacles



2255



MAIL DROPS PRIVATE ACCESS

Constructed of 1/4" thick aluminum plate and 20 gauge steel, Salsbury recessed mounted mail drops feature a spring-loaded mail flap and an adjustable mail flap stop. Mail drops also feature a durable powder coated finish available in five (5) contemporary colors. Custom engraving (#2266) is available as an option upon request. An optional receptacle (#2256 - see page 49 - order separately) aligns with the mail drop chute for receipt of deliveries. Mail drops are ideal for collecting documents and small packages and may be used for U.S.P.S. residential door mail delivery.



#2255 with optional custom engraving - black filled (#2266) displayed

CUSTOM ENGRAVING (OPTION - #2266)

Custom engraving (specify regular or black filled) is available as an option upon request. Examples are: MAIL, PAYMENTS, OUTGOING MAIL, LETTERS, KEYS, SUGGESTION BOX, OFFICE, RENT DROP or as specified. \$20.00

MAIL SLOT (STANDARD)

Mail drops feature an 11" W x 4" H mail slot.

CHUTE (STANDARD)

Attached to each mail drop is a 11-3/4" W x 5" H x 6-1/4" D chute angled at 25°.

ADJUSTABLE MAIL FLAP STOP (STANDARD)

Attached to the inside of each mail drop chute is an adjustable mail flap stop that can limit the size of the mail flap opening.

2255 Mail Drop

- 14" W x 7" H x 6" D
- mail slot: 11" W x 4" H
- rough opening: 12-1/4" W x 5-1/2" H
- 10 lbs.
- \$100.00

custom
Numbers / Letters see page 101

Specify



aluminum



brass



bronze



sandstone



green

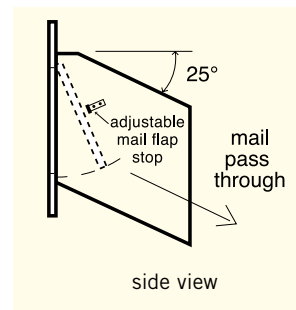



#2255 with optional custom engraving - regular (#2266) displayed

RECEPTACLES PRIVATE ACCESS

Made of sheet and extruded aluminum, Salsbury receptacles have a 12" W x 6" H rear opening which aligns with mail drops (#2255 - see page 48 - order separately). Receptacles have heavy duty 1/4" thick aluminum doors and are accessed from the front. Receptacles include a lock with two (2) keys and feature a durable powder coated finish available in five (5) contemporary colors. Custom engraving (#2266), plexiglass windows (#2273) and thumb latches (#2288) are available as options upon request.

2256 Receptacle

- 15" W x 19" H x 7-1/2" D
- rear opening: 12" W x 6" H
- 20 lbs.
- \$150.00

- Specify • aluminum
• brass
• bronze
• sandstone
• green

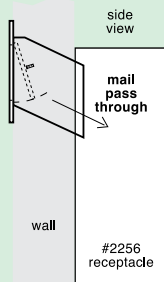

order mail drops and receptacles separately



CUSTOM ENGRAVING (OPTION - #2266)

Custom engraving (specify regular or black filled) is available as an option upon request. Examples are: OUTGOING MAIL, MAIL, PAYMENTS, LETTERS, KEYS, SUGGESTION BOX, OFFICE, RENT DROP or as specified. \$20.00

PLEXIGLASS WINDOW (OPTION - #2273)

A 2" W x 10" H plexiglass window is available as an option upon request. \$25.00

THUMB LATCH (OPTION - #2288)

A non-locking thumb latch is available as an option upon request. \$10.00



#2256 with optional custom engraving - regular (#2266) and mail drop (#2255) displayed



2256



Courier Boxes



COURIER BOXES PRIVATE ACCESS

Made of 14 gauge steel, Salsbury courier boxes provide a convenient means of depositing and collecting mail, documents, small packages and other items. Courier boxes feature a durable powder coated finish available in three (3) contemporary colors (or primer). Custom colors (#4905) are available as an option upon request. Each courier box user access door is equipped with a three (3) point locking mechanism with three (3) keys to protect its contents. Courier boxes can withstand severe weather conditions and are suitable when a secure environment is required. Courier boxes are ideal for colleges and schools, military bases, commercial buildings, libraries, government agencies, businesses and many other applications.

CUSTOM ENGRAVED PLACARDS

12" W x 2" H custom engraved self-adhesive placards are available as an option upon request. (#4967 - \$15.00)

AFTER HOURS DROP



Lock - standard replacement - with (3) keys (#4990 - \$15.00)

custom
Numbers / Letters see page 101

#4975 in blue finish with optional custom engraved placard (#4967) displayed

COURIER BOX OPENINGS



Convenient depositing of items



Secure collection of items

FRONT ACCESS ON #4975

15-3/4" W x 7" H package drop opening

15-3/4" W x 11-3/4" H user access opening

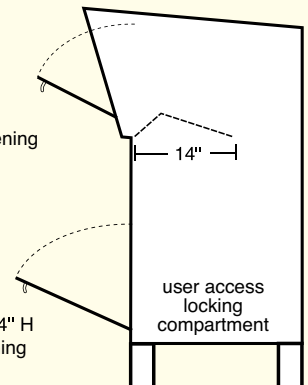



4975



4975 Courier Box

- 20" W x 49" H x 26" D
- package drop opening: 15-3/4" W x 7" H
- storage area: 19" W x 28" H x 21" D
- 160 lbs.
- \$600.00

Specify



gray



white



blue



primer



custom color
(order #4905
- \$100.00)

BASE BOLT PATTERN

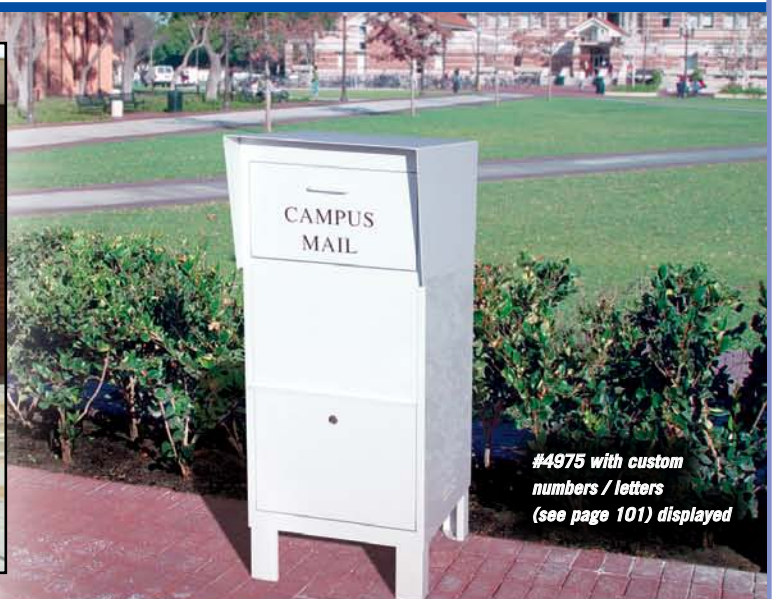
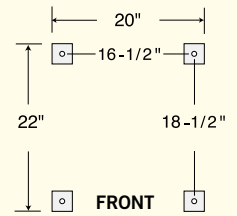

#4975 with custom numbers / letters (see page 101) displayed



#3475 in bronze finish with optional custom engraved placards (#3465) displayed

PEDESTAL COLLECTION BOXES PRIVATE ACCESS

Made of heavy duty aluminum, Salsbury 3400 series pedestal collection boxes provide a convenient means of depositing and collecting mail, documents, small packages and other items. Pedestal collection boxes feature a 12" W x 7-5/8" H front access hopper door and are available in two (2) heights. Pedestal collection boxes – regular (#3450) are 49-1/8" high and feature a 14" high collection compartment. Pedestal collection boxes – tall (#3475) are 56-1/8" high and feature a 21" high locking collection compartment. Both pedestal collection boxes are the same width (17-1/2") and depth (19"). Pedestal collection boxes include a 13" high matching pedestal and a master commercial lock. The durable and corrosion resistant units are designed for indoor or outdoor use and feature a powder coated finish available in six (6) contemporary colors. For matching 4C pedestal mailboxes, see pages 24-27.

CUSTOM ENGRAVED PLACARDS

9" W x 2" H custom engraved self-adhesive placards are available as an option upon request. (#3465 - \$15.00)

AFTER HOURS DROP



PEDESTAL COLLECTION BOX OPENINGS



Convenient depositing of items



Secure collection of items

FRONT ACCESS ON #3450 AND #3475

12" W x 7-5/8" H hopper door

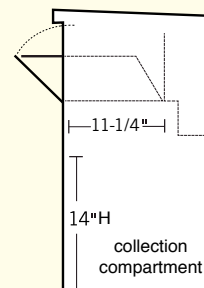

3450 (side view)

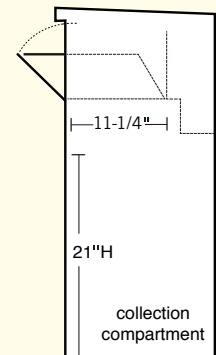

3475 (side view)



3450

3450 Pedestal Collection Box - regular

- 17-1/2" W x 49-1/8" H x 19" D
- 90 lbs.
- \$650.00

Specify

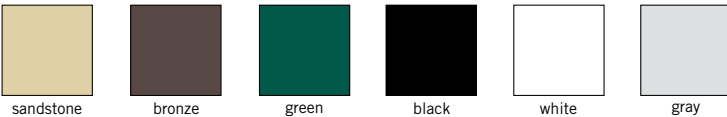

3475

3475 Pedestal Collection Box - tall

- 17-1/2" W x 56-1/8" H x 19" D
- 100 lbs.
- \$750.00



#3475 in gray finish with custom numbers / letters (see page 101) displayed

Matching pedestals are included with Pedestal Collection Boxes



#3450 in black finish with custom numbers / letters (see page 101) displayed

3400 COLLECTION BOX OPTIONS

MASTER COMMERCIAL LOCK

- For 3450 and 3475
- With (2) keys
- (#3477 - \$25.00)

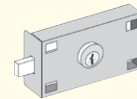

#3477

PEDESTAL REPLACEMENT

- 12" W x 13" H x 12" D
- 25 lbs
- (#3485 - \$100.00)

Specify

- sandstone
- bronze
- green
- black
- white
- gray



#3485

PEDESTAL MOUNTING KIT

- (4) 1/2" X 12" anchor (j) bolts
- 3 lbs
- (#3494 - \$25.00)

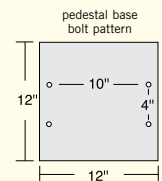
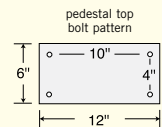

Pedestal Drop Boxes



#4275's with optional custom engraved placards (#4267) displayed

PEDESTAL DROP BOXES



Made entirely of aluminum, Salsbury 4200 series pedestal drop boxes are available in three (3) different sizes. Model #4275 is 15-3/4" wide, model #4276 is 23" wide and model #4277 is 30-1/4" wide. All pedestal drop boxes include a 28-1/2" high matching pedestal and are the same height (55-1/2") and depth (19"). Standard units are accessed from the rear through a two (2) point latching master door on the #4275 and two (2) master doors on the #4276 and #4277. Each door swings open over 90 degrees for unloading convenience. Standard units include a locking "T" handle (#4290) on the rear door(s), a weather protection hood and a mail flap on the front of the unit. The pedestal drop boxes feature a durable powder coated finish available in three (3) contemporary colors (or primer). Custom options (#4280 - see page 55) and custom colors (#4205) are available upon request.



Rear view of #4276 with open doors displayed



Replacement T-handle lock (with (2) keys) (#4290 - \$40.00)



Front view of #4276 with open mail flap displayed

PEDESTAL DROP BOXES - INCLUDES DROP BOX, PEDESTAL AND T-HANDLE LOCK

MODEL	DESCRIPTION	UNIT SIZE	WEIGHT	PRICE
4275 ¹	Pedestal Drop Box - regular mail slot: 12" W x 2" H	15-3/4" W x 55-1/2" H x 19" D	45 lbs.	\$500.00
4276 ¹	Pedestal Drop Box - large mail slot: 18" W x 2" H	23" W x 55-1/2" H x 19" D	55 lbs.	\$550.00
4277 ¹	Pedestal Drop Box - jumbo mail slot: 20" W x 2" H	30-1/4" W x 55-1/2" H x 19" D	65 lbs.	\$600.00
4285 ¹	Pedestal - replacement top: 13" W x 11-1/2" D base: 12" W x 6" D	4" W x 28-1/2" H x 5-1/2" D	20 lbs.	\$100.00
4205	Custom color - specify color	add		\$100.00
4280	Custom option - for Pedestal Drop Boxes (specify A, B, C, D, E, F)	add		\$100.00
4294	Pedestal mounting kit - (4) anchor (j) bolts - for new concrete installations	3 lbs.		\$25.00

¹ Specify



gray



white



blue



primer



custom color (order #4205 - \$100.00)

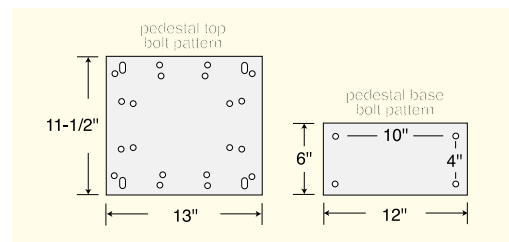

CUSTOM ENGRAVED PLACARDS

12" W x 2" H custom engraved self-adhesive placards are available as an option upon request. (#4267 - \$15.00)

DEPOSITS



CUSTOM PEDESTAL DROP BOX OPTIONS #4280

Pedestal drop boxes can be customized to meet your specific needs. The following options for pedestal drop boxes #4275, #4276 and #4277 are available upon request. Order #4280 for any one of the following options or specify your exact needs. Pedestal drop boxes are ideal for colleges and schools, military bases and many other applications.

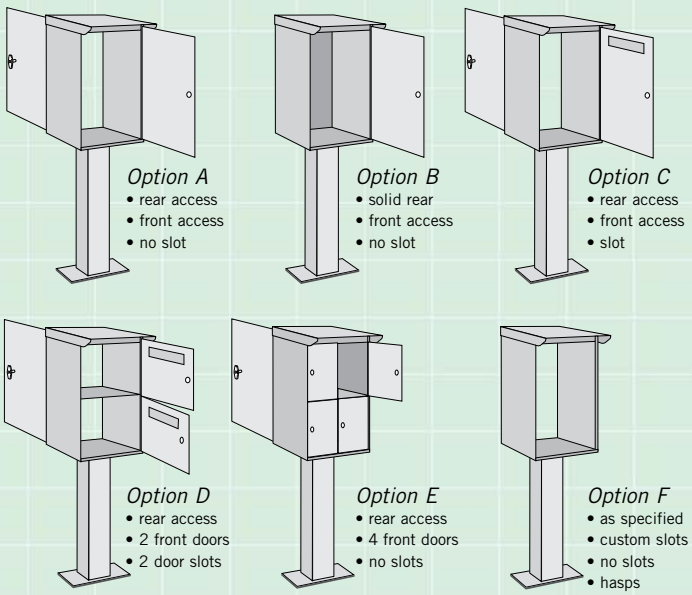

Final inspection of pedestal drop boxes

Note: U.S.P.S. front or rear access not available.

#4275 units with custom options (#4280) displayed

Mail Package Drops



#4375 attached to bolt mounted pedestal (#4395) with custom numbers / letters (see page 101) displayed

ALL ALUMINUM CONSTRUCTION

custom
Numbers / Letters see page 101



Front view of #4375 displayed



Rear view of #4375 displayed



4375

bolt mounted pedestal #4395

MAIL PACKAGE DROPS - U.S.P.S. APPROVED

Made entirely of aluminum, Salsbury U.S.P.S. approved 4300 series mail package drops feature both a front and rear access locking door. Mail is deposited through a non-locking access panel on the front. Each unit includes an outgoing mail tray, a lock with two (2) keys on each door (keyed alike) and an adjustable red signal flag. Units are available in a powder coated black, green, silver or white finish. Mail package drops can be mounted on the optional bolt mounted (#4395) or in-ground mounted (#4385) aluminum pedestals or a base of your choice. Non-locking thumb latches (#4388) are available as an option upon request. Mail package drops are approved for U.S.P.S. curbside mail delivery. Master postal lock not required.

CUSTOM ENGRAVED PLACARDS

8-1/2" W x 2" H custom engraved self-adhesive placards are available as an option upon request. (#4367 - \$15.00)

ABC STEEL CO.

123 MAIN STREET

REPLACEMENT FLAGS

Made of heavy duty aluminum, mail package drop replacement signal flags have a durable powder coated red finish and include stainless steel mounting hardware.



4316

4316 Replacement Flag

- 2-3/4" W x 8" H x 1/4" D
- 1 lb.
- \$10.00



bolt mounted pedestal #4395

order pedestals separately



in-ground mounted pedestal #4385



in-ground mounted pedestal #4385

MAIL PACKAGE DROPS - FRONT AND REAR ACCESS - U.S.P.S. APPROVED

MODEL	DESCRIPTION	UNIT SIZE	WEIGHT	PRICE
4375 ¹	Mail Package Drop - front and rear access	14-3/8" W x 36" H x 23" D	50 lbs.	\$300.00
4395 ¹	Pedestal - bolt mounted	3-1/2" W x 16" H x 3-1/2" D	10 lbs.	\$80.00
		top & base: 6" W x 12" D		
4385 ¹	Pedestal - in-ground mounted	3-1/2" W x 48" H x 3-1/2" D	20 lbs.	\$80.00
		top: 6" W x 12" D		
4390	Lock set - (2) standard replacement locks (keyed alike) - with (2) keys each			\$15.00
4394	Pedestal mounting kit - (4) anchor (j) bolts - for new concrete installations		3 lbs.	\$25.00

¹ Specify



black



green



silver



white



A non-locking thumb latch is available as an option upon request (#4388 - \$10.00)

FRONT AND REAR ACCESS ON #4375

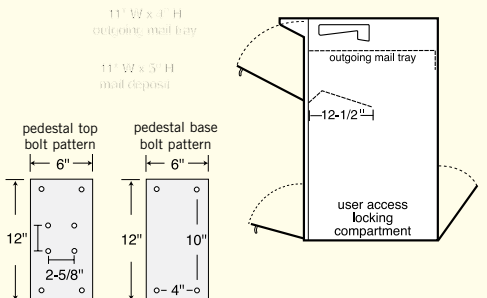

Mail Chests



(3) #4350's on a three (3) wide spreader (#4383) attached to a bolt mounted pedestal (#4365) with custom numbers / letters (see page 101) displayed



4350

bolt mounted pedestal #4365



4315

NEWSPAPER HOLDERS

Made of heavy duty aluminum, Salsbury newspaper holders are a unique option for mail chests. Each unit has a solid back and includes mounting hardware to easily attach to the bottom of mail chests and to the top of pedestals and spreaders. Newspaper holders feature a durable powder coated finish available in four (4) contemporary colors.

- 4315 Newspaper Holder**
- 10-1/4" W x 5" H x 12-1/4" D
 - 10 lbs.
 - \$50.00

Specify • black • green • silver • white

MAIL CHESTS - U.S.P.S. APPROVED

Made entirely of aluminum, Salsbury U.S.P.S. approved 4300 series mail chests feature both a front and rear access locking door. Mail is deposited through a non-locking access panel on the front. Each unit includes an outgoing mail tray, a lock with two (2) keys on each door (keyed alike) and an adjustable red signal flag. Units are available in a powder coated black, green, silver or white finish. Mail chests can be mounted on the optional bolt mounted (#4365) or in-ground mounted (#4385) aluminum pedestals or a base of your choice. Mail chests can also be mounted in columns, masonry or walls. Newspaper holders (#4315) and non-locking thumb latches (#4388) are available as options upon request. Mail chests are approved for U.S.P.S. curbside mail delivery. Master postal lock not required. For a smaller version of this product, see roadside mailboxes on pages 64-67.



Rear view of (#4350) mounted in a column displayed

SPREADERS

Made of heavy duty aluminum, Salsbury spreaders are an ideal way to mount multiple mail chests to pedestals. Optional two (2) wide (#4382) and three (3) wide (#4383) spreaders easily attach to standard pedestals (#4365 and #4385).



#4382 on a pedestal (#4365) displayed

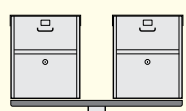

#4382 (2) wide spreader

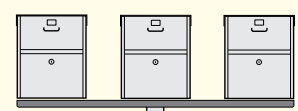

#4383 (3) wide spreader



order pedestals separately

bolt mounted pedestal #4365

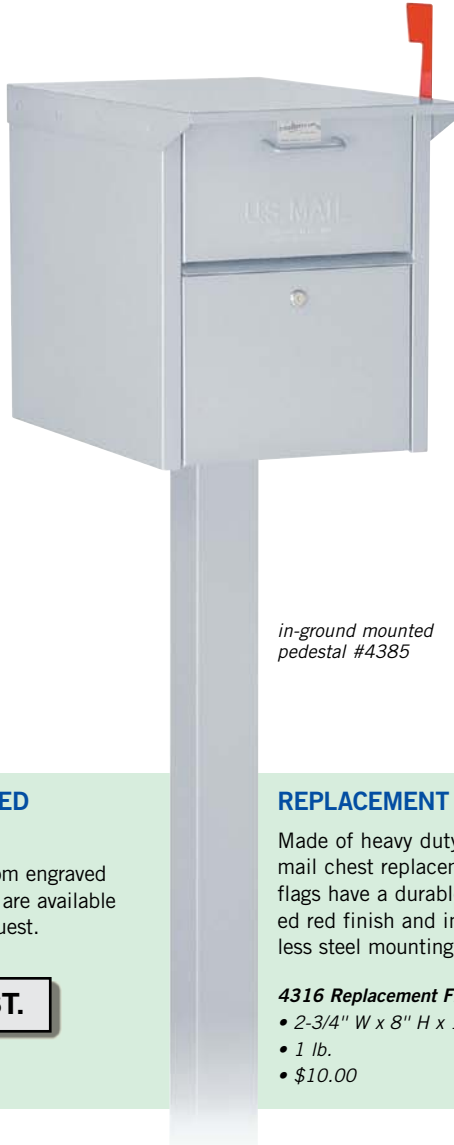

in-ground mounted pedestal #4385



in-ground mounted pedestal #4385

CUSTOM ENGRAVED PLACARDS

8-1/2" W x 2" H custom engraved self-adhesive placards are available as an option upon request. (#4367 - \$15.00)

140 THIRD ST.

REPLACEMENT FLAGS

Made of heavy duty aluminum, mail chest replacement signal flags have a durable powder coated red finish and include stainless steel mounting hardware.

- 4316 Replacement Flag
- 2-3/4" W x 8" H x 1/4" D
- 1 lb.
- \$10.00



THUMB LATCH

A non-locking thumb latch is available as an option upon request. (#4388 - \$10.00)

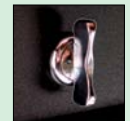

MAIL CHESTS - FRONT AND REAR ACCESS - U.S.P.S. APPROVED

MODEL	DESCRIPTION	UNIT SIZE	WEIGHT	PRICE
4350 ¹	Mail Chest - front and rear access	14-3/8" W x 17-1/4" H x 23" D	30 lbs.	\$200.00
4315 ¹	Newspaper Holder	10-1/4" W x 5" H x 12-1/4" D	10 lbs.	\$50.00
4365 ¹	Pedestal - bolt mounted	3-1/2" W x 32" H x 3-1/2" D top & base: 6" W x 12" D	15 lbs.	\$80.00
4385 ¹	Pedestal - in-ground mounted	3-1/2" W x 48" H x 3-1/2" D top: 6" W x 12" D	20 lbs.	\$80.00
4382 ¹	Spreader - 2 wide	34" W x 9" D	10 lbs.	\$50.00
4383 ¹	Spreader - 3 wide	55" W x 9" D	15 lbs.	\$60.00
4390	Lock set - (2) standard replacement locks (keyed alike) - with (2) keys each			\$15.00
4394	Pedestal mounting kit - (4) anchor (j) bolts - for new concrete installations		3 lbs.	\$25.00

¹ Specify



black



green



silver



white



FRONT AND REAR ACCESS ON #4350

11" W x 2-3/4" H
outgoing mail tray
11" W x 2" H
mail deposit

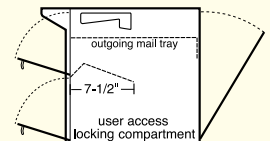

4350

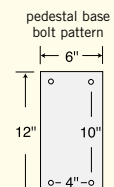
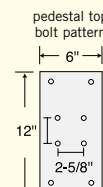

Postal Specialties



3302

OUTDOOR PARCEL LOCKERS (OPL's)



Made of heavy duty aluminum, 3300 series U.S.P.S. approved front loading outdoor parcel lockers (OPL's) have two (2) 12" W x 19-3/4" H x 15" D compartments and include a 14-1/2" high matching pedestal. Pedestal mounting kits are available - see below. As a compliment to an existing mailbox system, outdoor parcel lockers offer tenants a convenient way to receive packages on site and are fit with a two (2) key security system. Units feature a durable powder coated finish available in six (6) contemporary colors. For matching Cluster Box Units and Regency® Decorative Cluster Box Units, see pages 6-11.

3302 Outdoor Parcel Locker

- 16" W x 62-3/4" H x 18" D
- 85 lbs.
- \$975.00



Specify



sandstone



bronze



green

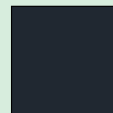

black



white

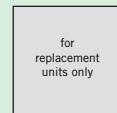

gray

- Specify
- For U.S.P.S. access
 - For private access - order master commercial lock #3375 \$25.00 - for access door and parcel locker

UNIVERSAL PEDESTALS

Made entirely of aluminum, Salsbury universal pedestals feature a durable powder coated aluminum finish and can be used as a replacement pedestal for the Neighborhood Delivery and Collection Box Unit (NDCBU) and many other applications. Pedestal mounting kits are available - see right.

3285 Universal Pedestal

- 4" W x 28-1/2" H x 5-1/2" D"
- top: 13" W x 11-1/2" D
- base: 12" W x 6" D
- 20 lbs.
- \$125.00

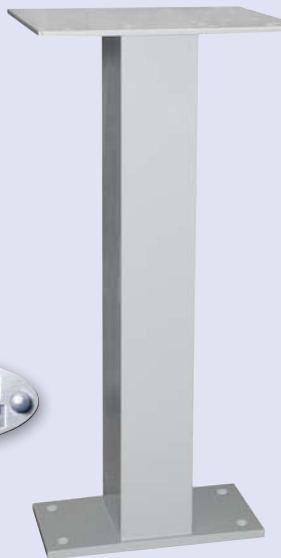

3285

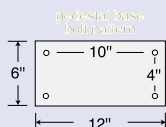
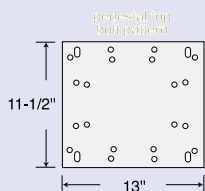

PEDESTAL MOUNTING KIT

Made of heavy duty zinc plated steel, Salsbury pedestal mounting kits are ideal for pedestal mounted installations in new concrete. Each pedestal mounting kit includes four (4) 1/2" x 12" anchor (j) bolts, washers and nuts. The pedestal mounting kit can be used for all Salsbury commercial bolt mounted posts and pedestals including CBU's, Regency CBU's, 4C Pedestal Mailboxes, Pedestal Collection Boxes, Pedestal Drop Boxes, Mail Chests, Mail Package Drops, OPL's and Universal Pedestals. Pedestal mounting kits can also be used for all Salsbury residential bolt mounted posts and pedestals.

3394 Pedestal Mounting Kit

- 3 lbs.
- \$25.00

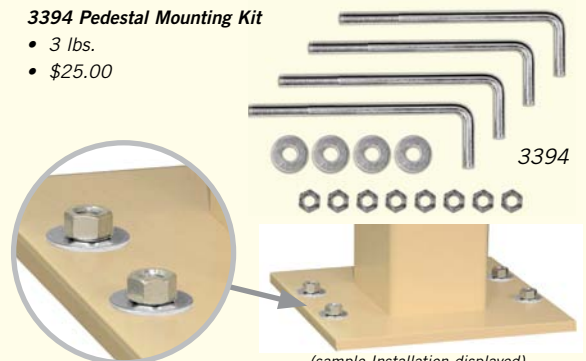

3394

(sample installation displayed)

PARCEL DROPS

Made of heavy duty 1/4" thick aluminum plate and 20 gauge sheet aluminum, Salsbury recessed mounted parcel drops feature a front access door for the delivery of packages and parcels. Parcel drops also feature a durable powder coated finish available in three (3) contemporary colors and are suitable for books, videos, e-commerce and many other applications. Custom engraving (#4966 - specify regular or black filled) is available as an option upon request.



4955

#4955 with custom engraving - regular (#4966 - \$20.00) displayed

4955 Parcel Drop

- 21" W x 16-1/2" H x 8-1/2" D
- drop opening: 12-1/4" W x 6" H
- rough opening: 14-1/2" W x 13-5/8" H
- 25 lbs.
- \$250.00

Specify • aluminum
• brass
• bronze



KEY CABINETS

Made of 20 gauge steel, Salsbury key cabinets are ideal for organizing and securing up to (200) keys. Key cabinets feature a full length piano hinge for smooth operation, a durable powder coated beige finish and a lock with two (2) keys.



1010

1010 Key Cabinet

- 13-1/4" W x 30-1/2" H x 1-3/4" D
- 25 lbs.
- \$100.00

KEY KEEPERS



Made of 20 gauge steel, Salsbury key keepers are available as surface mounted or recessed mounted units and feature a durable powder coated finish. A key keeper allows the U.S.P.S. or other individuals to access a key and deliver the mail and is useful when restricted access to a building or mailroom is required.



1080

1080 Key Keeper - surface mounted

- 6" W x 3-1/4" H x 2" D
- 2 lbs.
- \$40.00



1090

1090 Key Keeper - recessed mounted

- 6" W x 3-1/4" H x 2" D
- rough opening: 5" W x 2-1/2" H x 1-3/4" D
- 2 lbs.
- \$40.00

Specify • aluminum
• brass

Specify • For U.S.P.S. access
• For private access
(order commercial lock #1095 - \$25.00)

KEY LOCKERS

Made of zinc and aluminum alloy, Salsbury key lockers are powder coated black and provide convenient access to stored keys. A combination of four (4) numbers can be easily set and changed by the owner. Key lockers are available as surface mounted (#1075) and shackle style (#1076) units and include a sliding plastic shutter to protect the combination dials. Shackle style key lockers also include a black protective coating. Surface mounted key lockers easily mount to walls or other flat surfaces with four (4) screws (included) and shackle style key lockers can be hung from door handles or other suitable locations. Key lockers are ideal for quick and easy access to businesses and homes by children, friends, associates, realtors and emergency personnel.



1075

1075 Key Locker

- surface mounted
- 3" W x 4-1/2" H x 1-1/2" D
- 2 lbs.
- \$50.00



1076

1076 Key Locker

- shackle style
- 3" W x 6" H x 1-1/2" D
- 2 lbs.
- \$50.00

MAILBOX BANKS

Handcrafted of solid oak, mailbox banks include a 3-1/2" W x 5" H brass door, a lock with two (2) keys, a clear 1/4" thick glass window and a name plate.

1030 Mailbox Bank

- 5-3/4" W x 6-1/2" H x 5" D
- 3 lbs.
- \$50.00



1030

LABEL HOLDERS

Made of heavy duty plastic, transparent self-adhesive label holders neatly organize and identify mailbox compartments. White cardboard inserts are included.

1070 Label Holders

- 3" W x 3/8" H
- bag of (50)
- \$30.00

BOX 123

1070

Mailbox Locks / Key Blanks

CLUSTER BOX UNITS

Pages 6-11

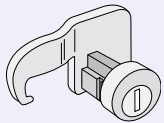

- 3390 Tenant Door Lock**
- for 3300 F series CBU's
 - with three (3) keys
 - \$15.00

- 3399 Box of (50) Key Blanks**
- for 3300 F series CBU's
 - \$30.00

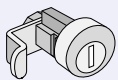

- 3390-E Tenant Door Lock**
- for 3300 E series CBU's
 - with three (3) keys
 - \$15.00

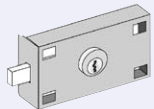

- 3375 Master Commercial Lock**
- for private access to master door and parcel locker door
 - with two (2) keys
 - \$25.00

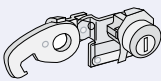

- 3376 Tenant Parcel Locker Lock**
- for parcel locker door
 - with three (3) keys
 - \$35.00

4C HORIZONTAL MAILBOXES

Pages 12-19

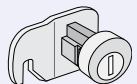

- 3790 Tenant Door Lock**
- for 3700 series 4C Horizontal mailboxes
 - with three (3) keys
 - \$15.00

- 3799 Box of (50) Key Blanks**
- \$30.00

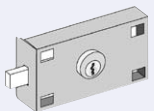

- 3775 Master Commercial Lock**
- for private access to master door and parcel locker door
 - with two (2) keys
 - \$25.00

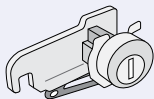

- 3776 Tenant Parcel Locker Lock**
- for parcel locker door
 - with three (3) keys
 - \$35.00

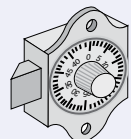

- 3786 Tenant Combination Lock**
- for 3700 series 4C Horizontal mailboxes
 - \$10.00

4C PEDESTAL MAILBOXES

Pages 24-27

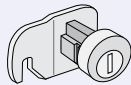

- 3490 Tenant Door Lock**
- for 3400 series 4C Pedestal mailboxes
 - with three (3) keys
 - \$15.00

- 3499 Box of (50) Key Blanks**
- \$30.00

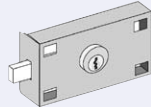

- 3477 Master Commercial Lock**
- for private access to master door and parcel locker door
 - with two (2) keys
 - \$25.00

4B+ HORIZONTAL MAILBOXES

Pages 28-31

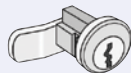

- 3690 Tenant Door Lock**
- for 3600 series 4B+ Horizontal mailboxes
 - with two (2) keys
 - \$8.00

- 3699 Box of (50) Key Blanks**
- \$30.00

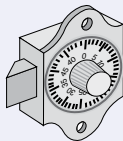

- 3686 Tenant Combination Lock**
- for 3600 series 4B+ Horizontal mailboxes
 - \$10.00

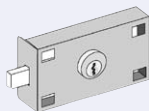

- 3675 Master Commercial Lock**
- for private access to master door and parcel locker door
 - with two (2) keys
 - \$25.00

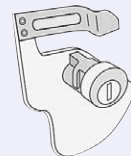

- 3676 Tenant Parcel Locker Lock**
- includes lock assembly
 - with two (2) keys
 - \$35.00

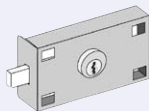

- 3677 Master Commercial Lock**
- for private access to 4B+ collection unit
 - with two (2) keys
 - \$25.00

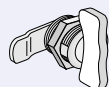

- 3689 Thumb Latch**
- for 3600 series 4B+ Horizontal mailboxes
 - \$3.00

VERTICAL MAILBOXES

Pages 32-33

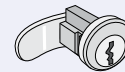

- 3590 Tenant Door Lock**
- for 3500 series Vertical mailboxes
 - with two (2) keys
 - \$8.00

- 3599 Box of (50) Key Blanks**
- \$30.00



- 3575 Master Commercial Lock**
- for private access to master door
 - with two (2) keys
 - \$25.00

UNIVERSAL MAILBOX REPLACEMENT LOCKS

Each universal mailbox replacement lock includes at least five (5) separate interchangeable cams to adapt to various mailbox manufacturers' door locks.

Items #1190 and #1195

include two (2) keys and three (3) keys, respectively and (100

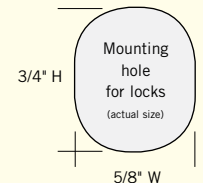

different key changes).

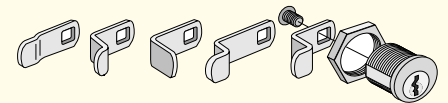

1190 Universal Lock

- for 4B+ Horizontal and Vertical styles
- nut mounted with two (2) keys
- \$15.00

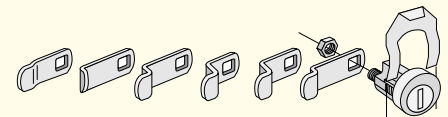

1195 Universal Lock

- for CBU E-series and NDCBU pedestal styles
- clip mounted with (3) keys
- \$15.00



1199 Universal Key Blanks

- for universal locks
- Box of (50)
- \$30.00

ALUMINUM MAILBOXES

Pages 34-37

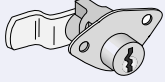

- 2290 Tenant Door Lock**
- for 2200 series Aluminum mailboxes
 - with two (2) keys
 - \$8.00

- 2299 Box of (50) Key Blanks**
- \$30.00

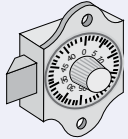

- 2286 Tenant Combination Lock**
- for 2200 series Aluminum mailboxes
 - \$10.00

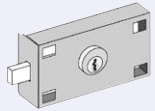

- 2275 Master Commercial Lock**
- for private access to 2270 & 2272 Parcel Locker doors
 - with two (2) keys
 - \$25.00

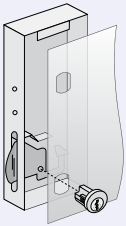

- 2276 Tenant Parcel Locker Lock**
- for 2270 & 2272 Parcel Lockers
 - includes assembly
 - with two (2) keys
 - \$35.00

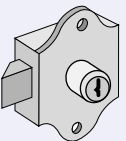

- 2287 Tenant Spring Latch Lock**
- for 2200 series Aluminum mailboxes
 - with two (2) keys
 - \$10.00

DATA DISTRIBUTION BOXES

Pages 38-39



- 2490 Tenant Door Lock**
- for 2400 series Data Distribution boxes
 - with two (2) keys
 - \$8.00

- 2499 Box of (50) Key Blanks**
- \$30.00

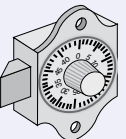

- 2486 Tenant Combination Lock**
- for 2400 series Data Distribution boxes
 - \$10.00

BRASS MAILBOXES

Pages 40-41



- 2090 Tenant Door Lock**
- for 2000 series Brass mailboxes
 - with two (2) keys
 - \$8.00

- 2099 Box of (50) Key Blanks**
- \$30.00

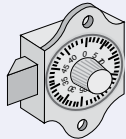

- 2086 Tenant Combination Lock**
- for 2000 series Brass mailboxes
 - \$10.00

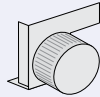

- 2089 Thumb Latch**
- for 2000 series Brass mailboxes
 - \$3.00



- 2092 Master Front Loading Door Lock**
- for 2000 series Brass mailboxes
 - with two (2) keys
 - \$10.00

AMERICANA MAILBOXES

Pages 42-43

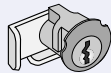

- 2190 Tenant Door Lock**
- for 2100 series Americana mailboxes
 - with two (2) keys
 - \$8.00

- 2199 Box of (50) Key Blanks**
- \$30.00

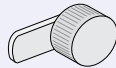

- 2189 Thumb Latch**
- for 2100 series Americana mailboxes
 - \$3.00



- 2192 Master Front Loading Door Lock**
- for 2100 series Americana mailboxes
 - with two (2) keys
 - \$10.00

ROTARY MAIL CENTERS

Page 44

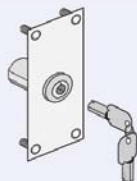

- 3175 Commercial Lock**
- for private access to 3100 and 3150
 - with two (2) keys
 - \$50.00

LETTER BOXES / RECEPTACLES

Pages 46-47, 49

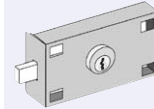

- 2246 Commercial Lock**
- for private access to 2240, 2245, 2256, 2260 and 2265
 - with two (2) keys
 - \$25.00

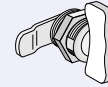

- 2288 Thumb Latch**
- for 2240, 2245, 2256, 2260 and 2265
 - \$10.00

COURIER BOXES

Pages 50-51



- 4990 Lock**
- for 4975
 - with three (3) keys
 - \$15.00

PEDESTAL COLLECTION BOXES

Pages 52-53

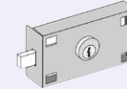

- 3477 Lock**
- for 3450 and 3475
 - with (2) keys
 - \$25.00

PEDESTAL DROP BOXES

Pages 54-55

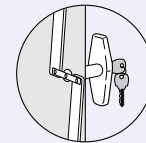

- 4290 "T-handle" Lock**
- for 4275, 4276 and 4277
 - with two (2) keys
 - \$40.00

MAIL PACKAGE DROPS / MAIL CHESTS

Pages 56-59

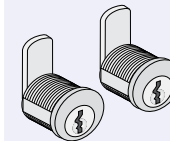

- 4390 Lock Set**
- for 4375 and 4350
 - set of (2) - keyed alike
 - with two (2) keys each
 - \$15.00

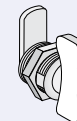

- 4388 Thumb Latch**
- for 4375 and 4350
 - \$10.00

KEY KEEPERS

Page 61

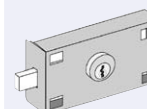

- 1095 Commercial Lock**
- for private access to 1080 and 1090
 - with two (2) keys
 - \$25.00