

Replacement Mailboxes

HORIZONTAL AND VERTICAL WALL-MOUNTED UNITS



For Postal Delivery

**1400 Series
STD-4B+
Horizontals**

**1250 Series
STD-4B+
Verticals**

For Private Delivery

**1600/1700
Series
Horizontals**

Always check with local U.S. Postal Service officials before proceeding with mailbox replacement projects.



Horizontal Recess Mounted



Vertical Recessed or Surface Mounted

MAILBOX REPLACEMENT GUIDELINES

You may replace your mailboxes with similar products on a **1:1 basis** if your renovation does not affect your rough opening.

USPS STD-4C compliant mailboxes are required for major renovation projects.



1:10 PARCEL LOCKER TO CUSTOMER COMPARTMENT RATIO REQUIRED BY USPS

Download the "Repair or Replace" guide from our Property Manager Toolkit on www.florencemailboxes.com/property-manager-toolkit



1400 Series Horizontals (STD 4B+)

FEATURES & OPTIONS

As an indoor solution, these traditional-style mailboxes are most popular in apartment complexes, and university/military housing. The standard for decades, these are available as replacement units for worn out installations. (All new construction must use postal approved STD-4C mailboxes.)

STANDARD FEATURES

- Front-load
- Recess-mounted
- Prepared for USPS installed Master Lock
- Anodized aluminum finish
- 5-pin cylinder tenant cam lock with two keys (1,000 key changes)
- Snap-on outer trim kit (available by request)
- Clear plastic number slots or engraved numbers



florencemailboxes.com/horizontal

OPTIONAL FEATURES

- Private master lock
- Dark Bronze powder coat color finish
- Configurable door sizes and layout options

Note: Horizontal mailbox installations should be protected from direct exposure to the weather; Florence is not responsible for damage caused by weather conditions as these products are rated for indoor use only.

DOOR SIZES

Standard horizontal mailboxes are pre-configured with the following door sizes:

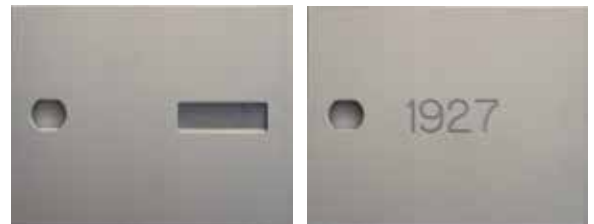
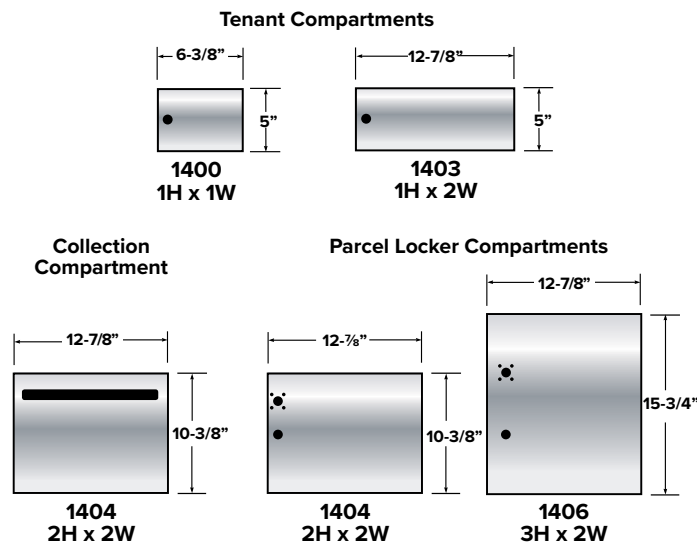

Plastic Number Slot: Number slots are 5/8”H x 2”W. (Available on tenant compartment doors only.)

Engraving: Custom engraving utilizes the USPS Standard US Block font and is 3/4” tall. All engraving can include up to 5 characters in one line per door.

LOCK DETAIL

Cam-lock is USPS Approved and standard on all horizontal mailboxes. Lock comes with two keys (1,000 key changes).



For lock maintenance, only graphite type lubricants are recommended on product locks. For additional assistance with locks, contact your local locksmith.

Configurable Modules

Sometimes a standard sized compartment is simply not big enough to suit your residents' needs. That's why you can change mail compartment sizes or add as many collection and/or parcel lockers as your installation requires. Simply begin with an all tenant standard module found on page 37, and modify it by placing any of the various door sizes and types found in the chart below.



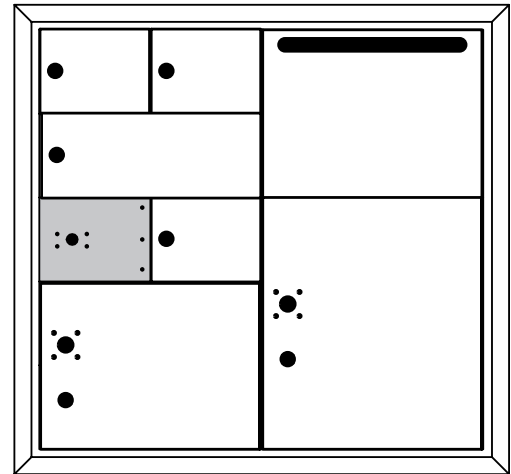

To quickly design your custom horizontal mailbox installation, Florence has developed an easy-to-use Revit mailbox configurator which is unique to the industry. This do-it-yourself online tool provides the opportunity for you to customize your configuration.

 florencemailboxes.com/configure



Our configurator tool does the math for you, provides a drawing and even allows you to submit your creation for quote!

COMPARTMENT OPTIONS Configurable units available in cabinet sizes 2 - 5 Wide and 5 - 7 High.

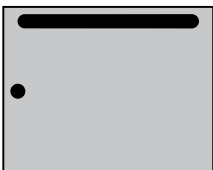
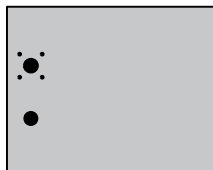
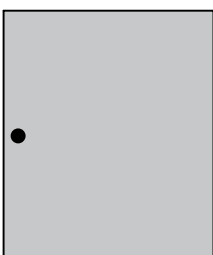
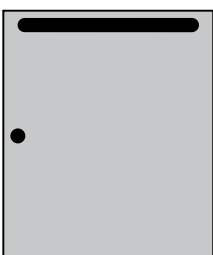
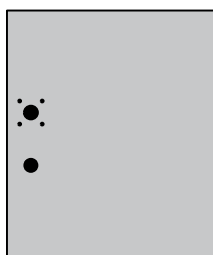
	Tenant Compartments	Collection Compartments	Parcel Locker Compartments
1400 One-High, One-Wide (5" H x 6-3/8" W)	 <p>NOTE: Tenant compartment ID options include plastic number slot or engraving.</p>	 <p>NOTE: Collection compartments are available with or without an access lock and can be engraved.</p>	
1403 One-High, Two-Wide (5" H x 12-7/8" W)			<p>NOTE: Parcel locker ID options includes engraving.</p>
1404 Two-High, Two-Wide (10-3/8" H x 12-7/8" W)			
1406 Three-High, Two-Wide (15-3/4" H x 12-7/8" W)			

5 DOORS HIGH

Actual: 28" H / Rough Opening: 28-1/4" H

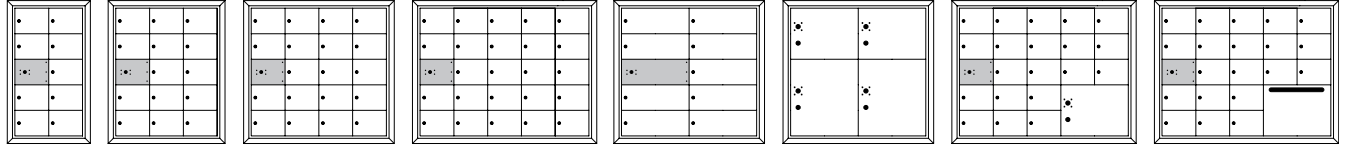

MODEL	140052A*	140053A*	140054A*	140055A*	140054DA	140054PLA	140055PLA	140055OUA
# Mailboxes (Total)	9	14	19	24	9	0	20	20
# Parcel Lockers (Total)	0	0	0	0	0	4	1	0
# Collection	0	0	0	0	0	0	0	1
Actual Width	14-3/8"	20-3/4"	27-1/4"	33-5/8"	27-1/4"	27-1/4"	33-5/8"	33-5/8"
Rough Opening	14-5/8"	21"	27-1/2"	33-7/8"	27-1/2"	27-1/2"	33-7/8"	33-7/8"

6 DOORS HIGH

Actual: 33-3/8" H / Rough Opening: 33-5/8" H

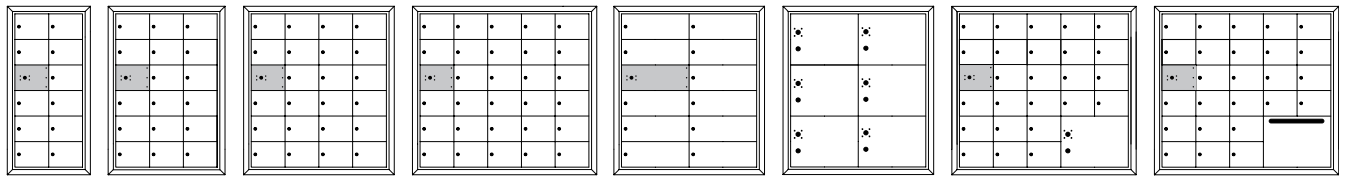

MODEL	140062A*	140063A*	140064A*	140065A*	140064DA	140064PLA	140065PLA	140065OUA
# Mailboxes (Total)	11	17	23	29	11	0	25	25
# Parcel Lockers (Total)	0	0	0	0	0	6	1	0
# Collection	0	0	0	0	0	0	0	1
Actual Width	14-3/8"	20-3/4"	27-1/4"	33-5/8"	27-1/4"	27-1/4"	33-5/8"	33-5/8"
Rough Opening	14-5/8"	21"	27-1/2"	33-7/8"	27-1/2"	27-1/2"	33-7/8"	33-7/8"

7 DOORS HIGH

Actual: 38-3/4" H / Rough Opening: 39" H

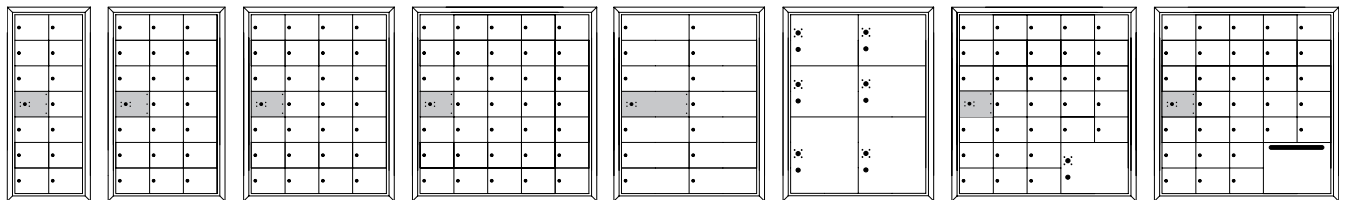

MODEL	140072A*	140073A*	140074A*	140075A*	140074DA	140074PLA	140075PLA	140075OUA
# Mailboxes (Total)	13	20	27	34	13	0	30	30
# Parcel Lockers (Total)	0	0	0	0	0	6	1	0
# Collection	0	0	0	0	0	0	0	1
Actual Width	14-3/8"	20-3/4"	27-1/4"	33-5/8"	27-1/4"	27-1/4"	33-5/8"	33-5/8"
Rough Opening	14-5/8"	21"	27-1/2"	33-7/8"	27-1/2"	27-1/2"	33-7/8"	33-7/8"

NOTES:

Standard modules noted with an asterisk (*) are fully configurable; visit florencemailboxes.com/configure to quickly and easily create your custom solution.

See pages 38 for compartment size definitions and configurable options.

All model numbers listed are for standard front-load modules; add -SP for custom modules at the end of the number.

1600/1700 Series Horizontals

FOR PRIVATE DELIVERY



A favorite of University housing managers, this indoor solution helps keep your mail area organized. Available in front-loading (1600 series) or rear-loading (1700 series) units, each module provides a lot of compartments in a small space. Since these are private delivery mailboxes, they are not constrained by postal installation regulations and therefore have no minimum or maximum mounting height requirements.

STANDARD FEATURES

- Recess-mounted
- Anodized aluminum finish
- 5-pin cylinder tenant cam lock with two keys (1,000 key changes)
- Snap-on outer trim kit (available by request)
- Clear plastic number slots or engraved numbers

OPTIONAL FEATURES

- Dark Bronze powder coat color finish
- Hinged rear doors with private lock (for 1700)
- Configurable door sizes and layout options

Plastic Number Slot: Number slots are 5/8”H x 2”W. (Available on tenant compartment doors only.)

Engraving: Custom engraving utilizes the USPS Standard US Block font and is 3/4” tall. All engraving can include up to 5 characters in one line per door.



Door Size: All standard units contain one door size. If you need more than the standard configurations shown on pages 42-43, our easy-to-use online configurator allows you to complete your project from the full range of size options.

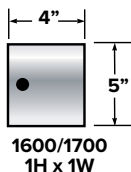

Rear-load mailboxes (1700 series) have an exposed back for easy distribution, so keep in mind during planning that additional space will be necessary for a secure room behind the installation. Access to the room may be restricted and easily accessed using a key keeper (see page 36) with a private lock.



Note: Horizontal mailbox installations should be protected from direct exposure to the weather; Florence is not responsible for damage caused by weather conditions as these products are rated for indoor use only.

LOCK DETAIL

Cam-lock is standard on all 1600/1700 horizontal mailboxes and comes with two keys (1,000 key changes).



For lock maintenance, only graphite type lubricants are recommended on product locks. For additional assistance with locks, contact your local locksmith.

Configurable Modules

Go beyond the standard and create your own custom mailbox!







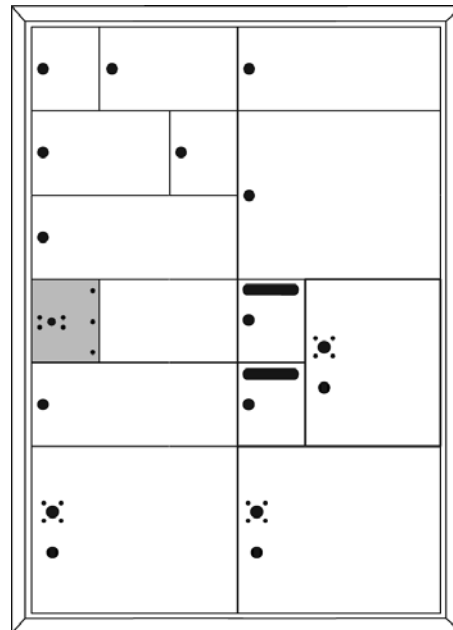

To quickly design your custom horizontal mailbox installation, Florence has developed an easy-to-use mailbox configurator which is unique to the industry. This do-it-yourself online tool provides the opportunity for you to place the doors not only where you want them, but with as many as you want (see door options in chart below). Our configurator tool will do the math for you, provide a drawing, and even allows you to submit your unique creation for quote!

So go ahead and add multiple collection compartments - it's your design!

 florencemailboxes.com/configure

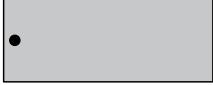

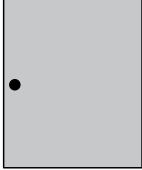
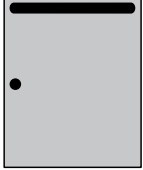
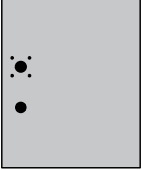
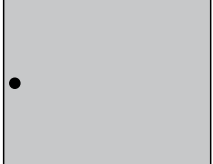
COMPARTMENT SIZES Configurable units available in cabinet sizes 3 - 6 Wide and 7 - 12 High.

	Tenant Compartments	Collection Compartments	Parcel Locker Compartments
1600/1700 One-High, One-Wide (5" H x 4" W)	 <p>NOTE: Tenant compartment ID options include plastic number slot or engraving.</p>	 <p>NOTE: Collection compartments are available with or without an access lock and can be engraved.</p>	
1603/1703 One-High, Two-Wide (5" H x 8-1/16" W)			
1605/1705 One-High, Three-Wide (5" H x 12-1/8" W)			<p>NOTE: Parcel locker ID options includes engraving.</p>
1604/1704 Two-High, Two-Wide (10-3/8" H x 8-1/16" W)			
1607/1707 Two-High, Three-Wide (10-3/8" H x 12-1/8" W)			

1600/1700 Series Horizontals Preconfigured Modules



7 DOORS HIGH

Actual: 38-3/4" H / Rough Opening: 39" H

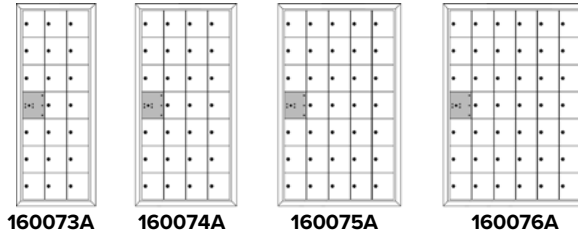

MODEL	160073A	160074A	160075A	160076A
# Mailboxes (Total)	20	27	34	41
Actual Width	13-3/4"	17-13/16"	21-7/8"	25-15/16"
Rough Opening	14"	18-1/16"	22-1/8"	26-3/16"

8 DOORS HIGH

Actual: 44-3/16" H / Rough Opening: 44-7/16" H

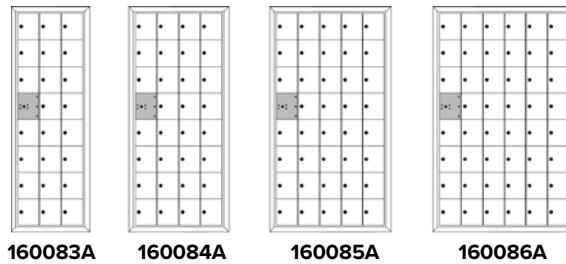

MODEL	160083A	160084A	160085A	160086A
# Mailboxes (Total)	23	31	39	47
Actual Width	13-3/4"	17-13/16"	21-7/8"	25-15/16"
Rough Opening	14"	18-1/16"	22-1/8"	26-3/16"

9 DOORS HIGH

Actual: 49-9/16" H / Rough Opening: 49-13/16" H

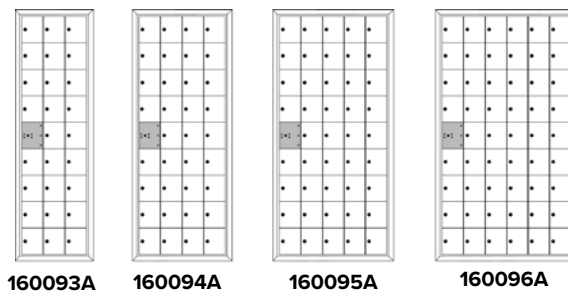

MODEL	160093A	160094A	160095A	160096A
# Mailboxes (Total)	26	35	44	53
Actual Width	13-3/4"	17-13/16"	21-7/8"	25-15/16"
Rough Opening	14"	18-1/16"	22-1/8"	26-3/16"

NOTES:

All standard horizontal mailbox modules shown above are also available in rear-load.
All model numbers listed are for front-load modules; change the first four numbers from 1600 to 1700 for rear-load modules and increase the max number of mailboxes by one.

10 DOORS HIGH

Actual: 55" H / Rough Opening: 55-1/4" H

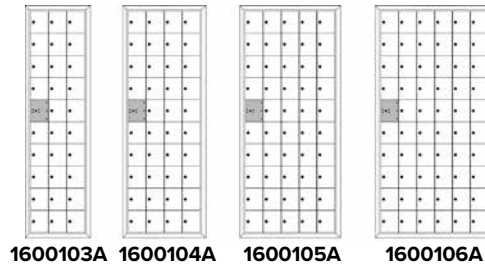

MODEL	1600103A	1600104A	1600105A	1600106A
# Mailboxes (Total)	29	39	49	59
Actual Width	13-3/4"	17-13/16"	21-7/8"	25-15/16"
Rough Opening	14"	18-1/16"	22-1/8"	26-3/16"

11 DOORS HIGH

Actual: 60-3/8" H / Rough Opening: 60-5/8" H

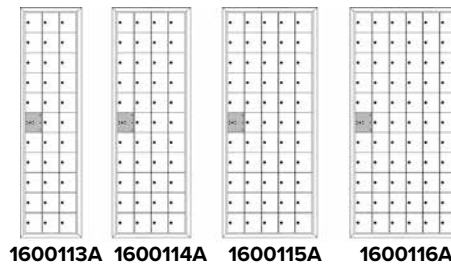

MODEL	1600113A	1600114A	1600115A	1600116A
# Mailboxes (Total)	32	43	54	65
Actual Width	13-3/4"	17-13/16"	21-7/8"	25-15/16"
Rough Opening	14"	18-1/16"	22-1/8"	26-3/16"

12 DOORS HIGH

Actual: 65-13/16" H / Rough Opening: 66-1/16" H



MODEL	1600123A	1600124A	1600125A	1600126A
# Mailboxes (Total)	35	47	59	71
Actual Width	13-3/4"	17-13/16"	21-7/8"	25-15/16"
Rough Opening	14"	18-1/16"	22-1/8"	26-3/16"

NOTES:

All standard horizontal mailbox modules shown above are also available in rear-load.

All model numbers listed are for front-load modules; change the first four numbers from 1600 to 1700 for rear-load modules and increase the max number of mailboxes by one.

1250 Vertical Mailboxes

PRODUCT FEATURES



Vertical mailboxes have been a staple for mail delivery in small apartment communities for decades. Vertical mailboxes can be used for Postal Delivery only when they replace older vertical mailboxes for one-to-one replacement purposes. Over the years, postal regulations have changed and these mailboxes are no longer approved for new construction. These units are top-loading and should be protected from the weather.

STANDARD FEATURES

- Top-load/front-load
- Recessed- or surface-mounted
- Prepared for USPS installed Master Lock
- Mailbox material: Anodized aluminum
- Surface collar material: Silver powder coated steel
- 5-pin cylinder cam locks with two keys (1,000 key changes)
- Name and number ID card holders



florencemailboxes.com/vertical

LOCK DETAIL

The 1250 vertical series comes standard with a K30809 lock.



K30809

DOOR SIZE

The 1250 vertical series mailbox is pre-configured with one door size.

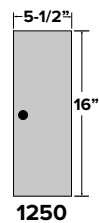

1250

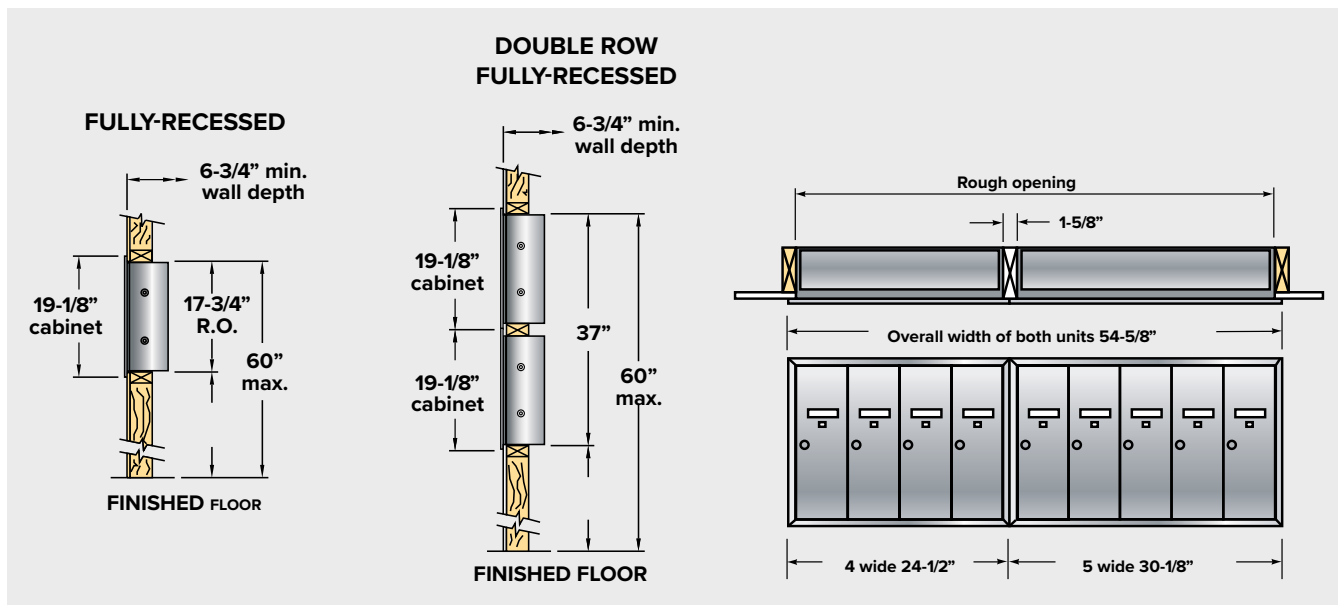

Good to Know

IMPORTANT PRODUCT INFO

5 YEAR PRODUCT WARRANTY

Product Warranty

Florence Corporation provides a five-year warranty on its products from the date of shipment when purchased from an Authorized Florence Dealer. Full details on the warranty, as well as how to find a local product expert nearest you, can be found by visiting our website or calling us today!

 florencemailboxes.com/warranty

Social Media

Follow and/or like us on the popular social media platforms so together we can further the discussion on centralized mail delivery, its products, and other topics of interest in the industry. Be sure to also check out our blog where we regularly share pertinent topics of interest as you design and install your mailbox system; and subscribe to our YouTube channel where you can find product feature and 'how-to' videos.



Made in the USA

Located in the American Heartland, Florence Corporation has proudly made centralized mail delivery and storage equipment since 1934. Our approach to manufacturing and quality control allows us to effectively and efficiently produce and ship product from our Manhattan, Kansas, facility. Our long standing American tradition and operation continues to be ISO certified for both our manufacturing and management processes as well as our environmental practices.

 florencemailboxes.com/made-in-the-usa



Materials

All product descriptions and specifications contained herein were in effect at the time the catalog received final approval for printing. Note that not all powder coat color finishes are available on all Florence product lines; see individual product listings for details. Pantone color numbers shown with finishes are for reference purposes only. Printed colors shown may vary slightly due to printing process. As Florence Corporation continually strives for efficiencies to pass along to our customers, we reserve the right to change specifications and/or designs without notice and without liability. Where appropriate, replacement items will be maintained during potential transition.

Return Policy

All product shipments are adequately packaged, but should be thoroughly inspected upon receipt and prior to acceptance, for potential damage in transit. Returned goods will not be accepted without an RGA (returned goods authorization) number, which must be obtained from the Authorized Florence Dealer with whom you completed the transaction. In the event a product is authorized for a return, a minimum 30% restock fee will apply for standard stock products. Outbound freight and return freight is not credited as part of the return. Custom orders and orders with options cannot be cancelled and will not be accepted for return, exchange, or refund.

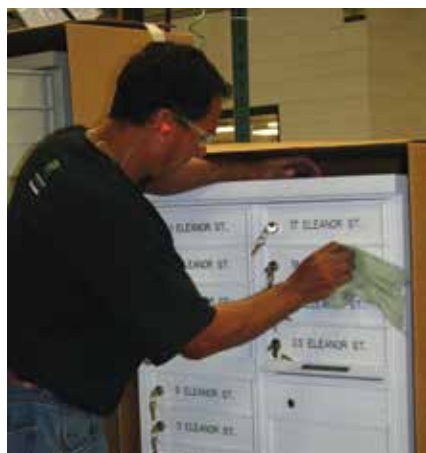

Care and Cleaning

The surface of all Florence clear aluminum or powder coated products may be cleaned of dirt or grime with a soft cloth dampened with any mild detergent or properly diluted biodegradable, water-based cleaner, such as "Simple Green™".

Wipe from top to bottom to avoid run-down. Avoid use of abrasives, which might damage the product surface. Rinse with plain water and dry. Avoid cleaning during extreme temperature conditions. Matching touch-up paint products may be available from an Authorized Florence Dealer for products which utilize powder coating.

Full details can be found at:

 florencemailboxes.com/cleaning

Copyright: Florence Corporation has made every effort possible to ensure the accuracy of all information contained within this publication. We reserve the right to correct inadvertent or typographical errors, inaccuracies or omissions - should they happen to occur - and to change or update information at any time without prior notice. All publication elements, including but not limited to, design, graphics, text, trademarks, art, and photographs, as well as the selection and arrangement thereof, are Copyright © 2018 Florence Corporation. All Rights Reserved. This catalog is intended for distribution by Florence Corporation and its Authorized Dealers for the sole purpose of purchasing products contained herein. Any other use of this publication, including modification or re-publication of any portion of the publication, without the prior written consent of Florence Corporation, is strictly prohibited. Printed in the USA on recycled paper.

Your Trusted Partner in Commercial and Residential Centralized Mailbox Designs for Over 85 Years!

Like all great stories, ours started in a garage. Elbow grease, a sweaty brow. It's that kind of story. More than 85 years later, we're still hard at it; continually perfecting our craft, allowing you to perfect yours. You may take our products for granted. We take that as a compliment. Our products don't require attention or fuss. They're built smart, designed to work, and engineered to last.

We empower our customers with the products, the support, and the tools to design faster. Build smarter. Manage better. We understand that in a world of global commerce, demands of efficiency and last minute deadlines, you need a partner that can keep pace. You've met your match with Florence. Established. Dependable. Strong. It's not just what we make...it's what makes us.

FLORENCE
 **CORPORATION**
Established. Dependable. Strong.

800.275.1747

FlorenceMailboxes.com

