

140054D Dimensions

Overall Width w/ Trim: 29-3/4"
(Rough Opening: 27-1/2")

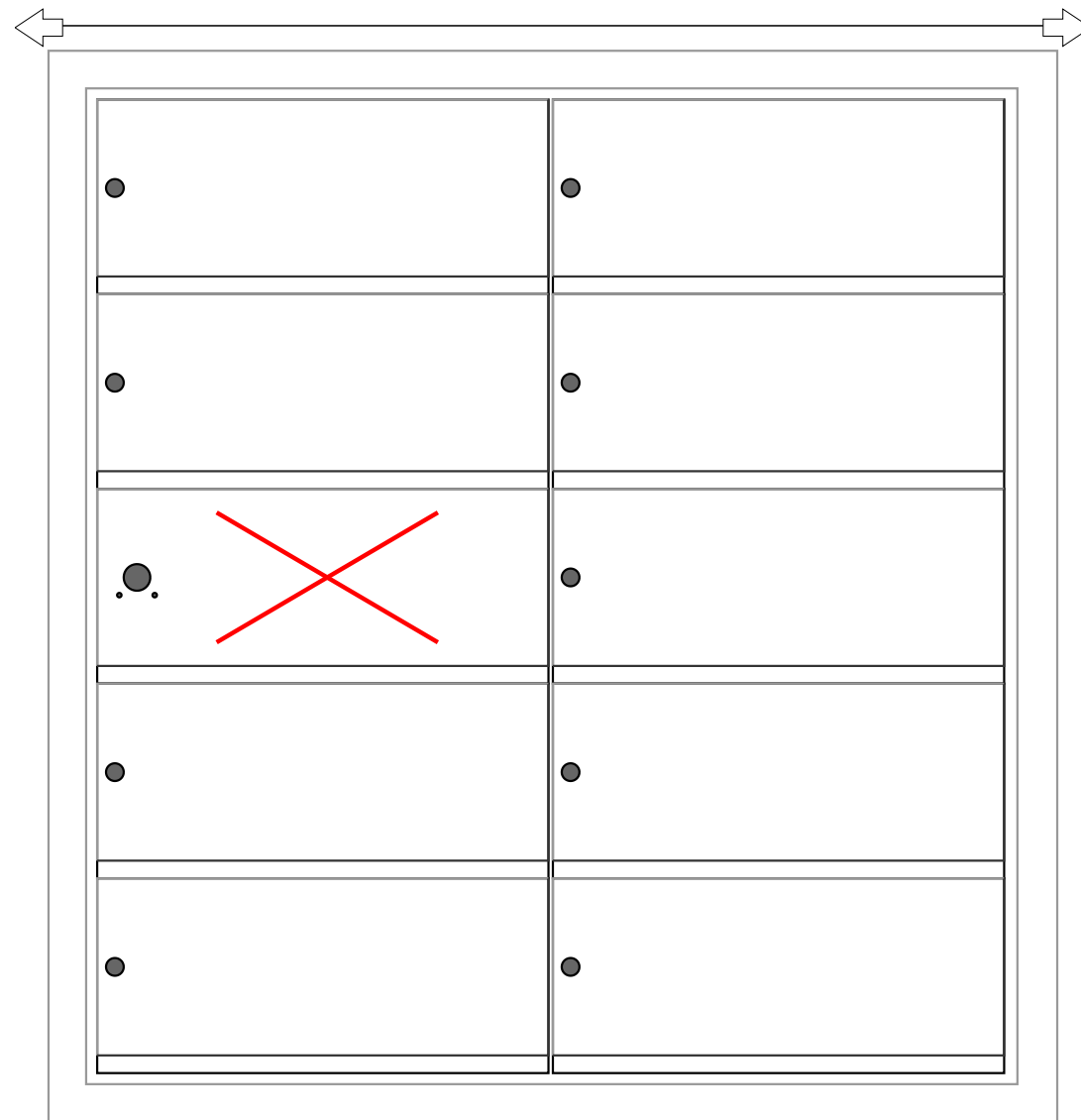

140054D

Side View

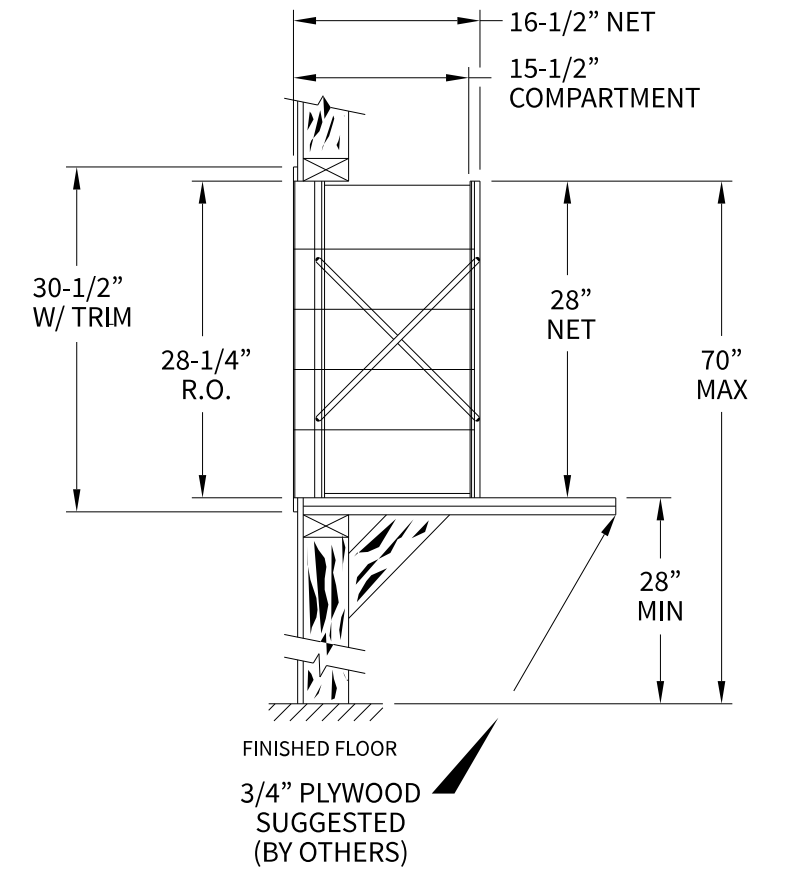

Configuration Details:

- 1. **Product Type:** 1400 Horizontal
- 2. **Installation:** Front-load, Recessed Mount
- 3. **Finish:** Anodized Aluminum
- 4. **Locks:** Standard Cam Lock, 2 keys
- 5. **Door Id:** tbd
- 6. **Master Door:** tbd

Matching standard snap-on trim included

Models Used:

(1) 140054D

DO NOT SCALE OFF DRAWING

Door Sizes Used:

(1) 1x2 Master
(9) 1403 1x2 Compartment

ELEVATION: 140054D | **MAILBOXES:** 9 |

PROJECT NAME: 1400 Series Mailbox

DRAWN BY: FLORENCE



BudgetMailboxes
Best Brands. Best Prices. .com

WebLife Stores LLC
PO Box 20338, Panama City Beach, FL 32417
www.budgetmailboxes.com • (866) 707-0008

DATE: 01-15-2016

P.O. NO:

SCALE: NONE

QUOTE NO:

DRAWING NO. WEB-1932

SHEET 1 OF 1