



# ***RADIOMASTER***

# **MT12**

## **Instruction manual**

Version: 1.1

**WWW.RADIOMASTERRC.COM**

This manual is adapted from the EdgeTX online manual, which is provided and maintained by the EdgeTX team under the [Creative Commons Attribution-ShareAlike 4.0 International \(CC BY-SA 4.0\) license](#). Full credit is given to the EdgeTX team and contributors. More details can be found here: [EdgeTX Online manual](#)

# Contents

1. Overview .....	4
1.1. Safety information.....	4
1.2. Radio overview.....	5
1.3. Battery and charging information .....	6
1.4. Manual and firmware download.....	6
1.5. How to enter Bootloader .....	6
1.6. Specifications .....	7
1.7. Warranty and repair .....	7
1.8. Disclaimer & Legal status and copyright .....	7
1.9. How to videos .....	8
2. User Interface.....	9
2.1. Button layout.....	9
2.2. Main View .....	10
2.3 Reset.....	11
2.4. Statistics .....	11
2.5. Custom RGB LED Setup .....	13
2.6. Switch and Joystick Expansion Modules .....	14
3. Model Settings .....	15
3.1. Model Select .....	15
3.2. Setup .....	15
3.2. Drive Modes .....	23
3.3. Fail Safe .....	25
3.4. Reversing a Servo .....	26
3.5. EXPO .....	26
3.6. Dual Rates .....	27
3.7. End points .....	27
Inputs, Mixes & Outputs .....	28
3.5. Inputs .....	28
3.6. Input configuration page.....	29
3.7. Mixes .....	31
3.8. Outputs .....	32
4. Curves.....	33
5.1 Setting curves .....	33
5. Logical Switches .....	34
6.1. Using Logical Switches.....	34

6. Special Functions.....	35
7.1. Configuring Special Functions .....	35
7. Telemetry .....	38
7.1. Sensors .....	38
7.2. Sensor Configuration.....	40
7.3. Common Telemetry Sensors .....	42
8. Display .....	43
8.1. Display screen configuration .....	43
9. Radio Settings.....	45
10.1. Tools .....	45
10.2. Radio Setup .....	45
10.3. Global Functions .....	47
10.4. Trainer .....	47
10.5. Hardware.....	48
10.6. Version .....	50
10. Contributors and Further information .....	51
11.1 Special thanks.....	51
11.2 Links and resources.....	52

# 1. Overview

Thank you for purchasing the RadioMaster MT12 radio system. Advanced and highly-versatile, MT12 is adaptable for drivers of any skill level. To ensure safe and reliable operations, please read this manual carefully prior to use.

As the software and hardware are constantly improved, the information contained in this manual is subject to change without prior notice. Please visit our website for up-to-date information and radio firmware.

MT12 is an open-sourced, ergonomic radio with powerful multi-protocol capability. Able to bind to most contemporary protocols on the market, this is one radio to rule them all! MT12 runs EdgeTX, an open-sourced operating system; for more information, please visit the EdgeTX link below.

-The RadioMaster team

## 1.1. Safety information

Radio-controlled models commonly contain sharp components like gears, rotating at high RPMs; when operating or maintaining the model, always use common sense and proceed with caution.

Always disconnect power to the model during the assembly or maintenance process.

Never operate the MT12 radio system in the following conditions:

- In severe weather or strong windy conditions, such as rain, hail, snow, storms or electromagnetic environments.
- In limited visibility
- In the proximity of other people, property, high-voltage power lines, public roads, vehicles or animals
- When feeling unwell, or under the influence of drugs or alcohol.
- If the MT12 radio system/model is damaged or showing signs of interference.
- In areas with high 2.4GHz interference or where 2.4GHz radios are prohibited.
- When the Transmitter or receiver battery is low.
- In areas where local regulations prohibit the use of R/C models.



### **WARNING!**

MT12 is pre-installed with the most stable firmware at the factory at time of release. Please only attempt to update the firmware if you are confident in the process. Incorrect firmware updates may cause the remote control to become inoperable. Damage as a result of improper firmware update may not be covered under warranty.

## 1.2. Radio overview

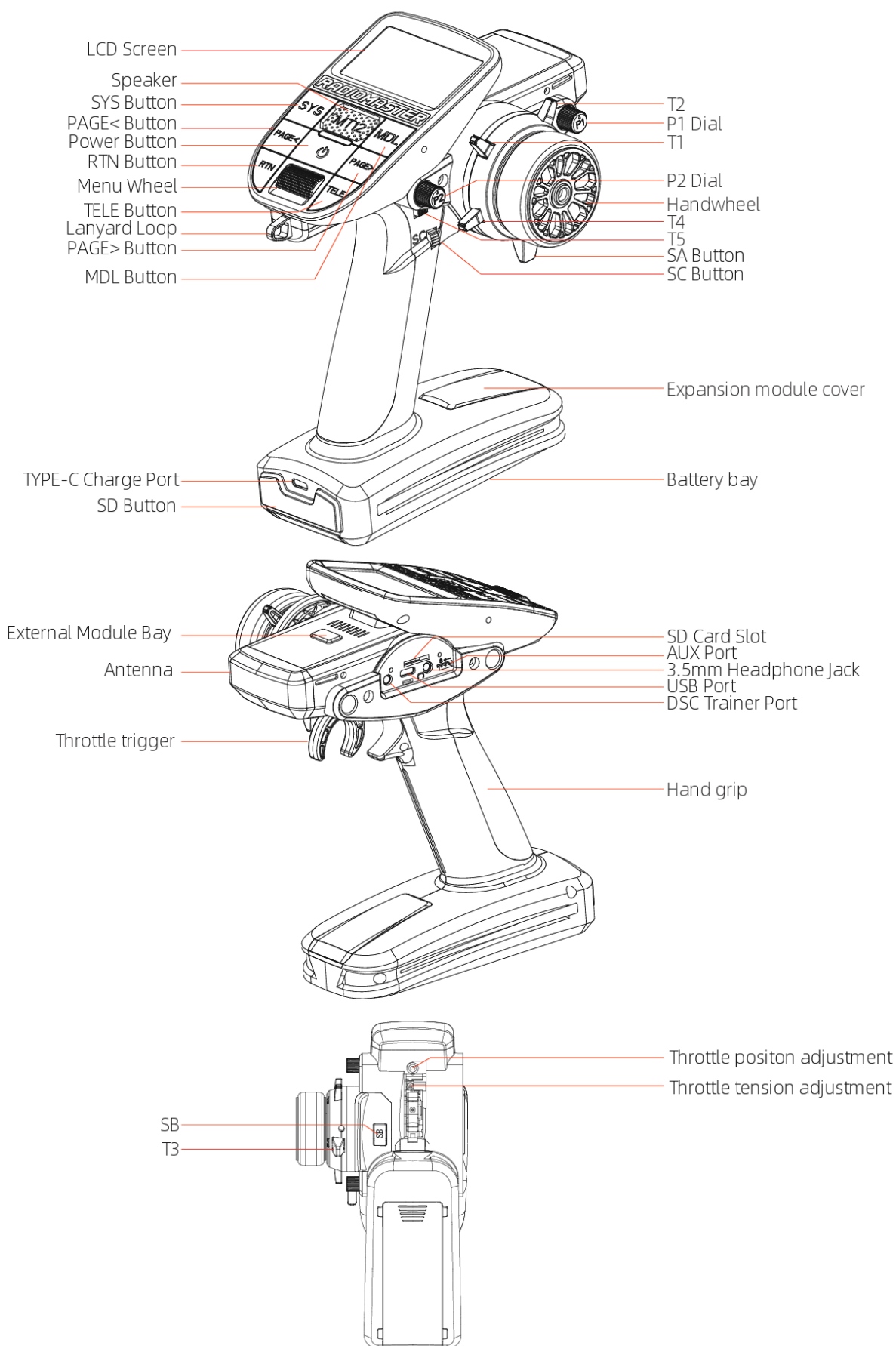

### 1.3. Battery and charging information

MT12 is powered by 2x 3.7V 18350 Lithium Ion cells and is charged using the built-in USB-C port. The charging circuitry is designed for charging 2x 3.7V Lithium Ion/Poly or 1x 7.4V Lipo battery pack only; the nominal voltage is 3.7V and the maximum charging voltage is 4.2V.

Never charge 3.6V LiFe and 3.6V 18350 Lithium Ion packs with the onboard charger. Charging or using the wrong battery chemistry/polarity may cause permanent damage to the PCB and in certain situations cause fires.

Check the voltage and condition of the battery regularly and never charge the device unattended. Only charge in safe areas away from combustible materials. Refrain from charging the radio unit if it was exposed to water or was damaged in any way. RadioMaster does not assume any responsibility for any adverse consequences caused by the use or misuse of this product.

### 1.4. Manual and firmware download

MT12 is pre-installed with factory approved EdgeTX firmware and is also capable of operating OpenTX. To download the latest manual or stock factory firmware, please visit the RadioMaster website: <https://www.radiomasterrc.com>

When updating your radio firmware and SD card Contents, we **strongly encourage** you to use [EdgeTX Buddy](#).

#### Updating from an earlier version of EdgeTX

[Update from an earlier version of EdgeTX using EdgeTX Buddy](#)

[Update from an earlier version of EdgeTX using the Bootloader](#)

### 1.5. How to enter Bootloader

Step 1. Press and hold T1 and T2 towards each other.

Step 2. Power on the radio to enter bootloader.

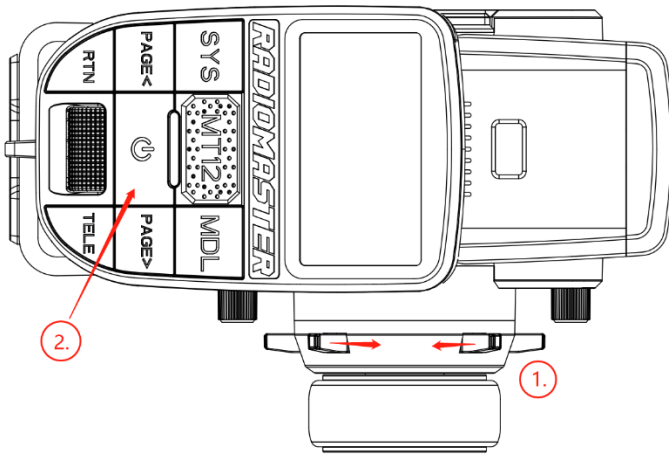

#### EdgeTX

<http://edgetx.org/> (Information about EdgeTX)

<https://buddy.edgetx.org/> (easy to use tool for FW updates)

<https://edgetx.gitbook.io/edgetx-user-manual/> (EdgeTX Online manual)

#### ExpressLRS

<https://www.expresslrs.org/quick-start/getting-started/> (ExpressLRS Online guide)

#### Multi-Module

<https://www.multi-module.org/> (Online resources)

## 1.6. Specifications

Physical dimensions : 177.8\*118.4\*207.8mm

Weight : 480 grams

Operating frequency : 2.400GHz-2.480GHz

Internal RF Options : 4-in-1 multi-protocol / ELRS 2.4GHz

Supported protocols : Module dependent

Operational current: 160mA for 4 in 1. 320mA for ELRS 250mW .

Operational voltage : 6.6-8.4V DC

Operating system : EdgeTX

Control channels : Maximum 16 (Rx dependent)

Display : 128\*64 Monochrome LCD

Battery : 2 x 18650 cells or a 2s 7.4v 5000mah battery pack (Batteries not included)

Charging : Built in USB-C Charging

Firmware Upgrade method : Via USB or SD card

Gimbal : Hall-effect

Module bay : Nano size (RadioMaster Ranger Nano Module / RadioMaster RM 4in1 module / TBS Crossfire Nano module)

## 1.7. Warranty and repair

Should any issues arise with your radio system's hardware, please keep the proof of purchase and contact the retailer where you made the MT12 purchase. You may also visit our warranty support page

<https://www.radiomasterrc.com/contact>

The limited warranty covers defects in workmanship for one year from the date of purchase

## 1.8. Disclaimer & Legal status and copyright

EdgeTX is open source firmware. No warranty or implied warranty is given for the quality and reliability of this firmware. If not handled properly, the RC model can cause serious injury or even death. If you decide to use EdgeTX firmware, you are solely responsible for your model. EdgeTX and RadioMaster are not liable for any injury or damage caused by using EdgeTX firmware or RadioMaster hardware. Use with caution.

This project is free software: you can redistribute and / or modify it in accordance with the GNU General Public License Agreement, V3 version agreement, or (optionally) an updated version agreement issued by the International Free Software Association. You should receive a copy of the GNU General Public License Agreement for the EdgeTX project. If not, see [www.gnu.org/licenses](http://www.gnu.org/licenses). EdgeTX is open sourced firmware for RC radio controllers. The firmware is highly configurable and has more features than traditional radios. Daily feedback from thousands of users ensures continuous firmware updates as well as stability and quality. The release of EdgeTX firmware hopes that it will benefit the public, but it has no warranty; it does not include implied commercial licenses or applicability for a special purpose. For more details, see the GNU General Public License Agreement. EdgeTX source files and more can be found at <https://github.com/opentx/opentx> and <https://github.com/edgetx/edgetx>.

## 1.9. How to videos



RadioMaster RC  
@RadioMasterRC



Check out these helpful videos:

- [How to bind an R85C Receiver with 4in1 MT12](#)
- [How to bind an ER3C-I receiver with ExpressLRS MT12](#)
- [How to Set D/R Dual Rate](#)
- [How to Set Expo](#)
- [How to Set Telemetry](#)
- [Servo Center, Travel and Reversing](#)



## 2. User Interface

### 2.1. Button layout

- **[SYS]** - System Button - Short press **[SYS]** button from the main screen to go to the tools page of the Radio Settings menu.
- **[MDL]** - Model Button - Short press **[MDL]** button from the main screen to go to the Model Select of the Models menu
- **[RTN]** - Return / Back - Short press **[RTN]** button to return to the previous page, previous menu or cancel action
- **[PAGE>]** / **[PAGE<]** - Page next & page previous - Used to navigate between different screens, tabs, or options settings, depending on the screen.
- **[TELE]** - Telemetry - Press the **[TELE]** button to go to the configured telemetry screens. More information about the telemetry screens is found in the Display section.
- **[Roller]** or **[Dial]** - Next & previous value. The roller is used to navigate through menu options.
- **[Enter]** - Accept - Used to select option, function or accept value - Push **[Roller]** button to select or enter.



## 2.2. Main View

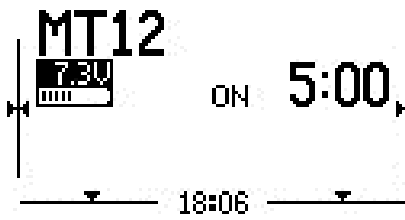

**Screen 1** - This view displays the model name, trim positions (if trims are enabled), clock, transmitter battery voltage, Drive mode, receiver signal strength, and Timers 1 and 2 (if enabled).

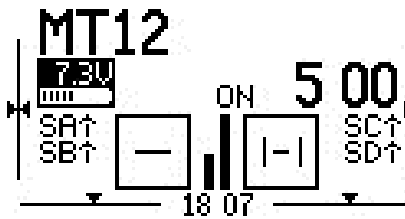

**Screen 2** - This view displays the model name, trim positions (if trims are enabled), clock, transmitter battery voltage, Drive mode, receiver signal strength, and Timer 1 (if enabled). It also has a graphical representation of the stick, pot, and switch positions.

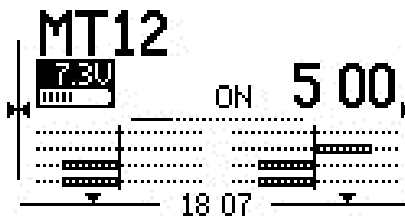

**Screen 3** - This view displays the model name, trim positions (if trims are enabled), clock, transmitter battery voltage, Drive mode, receiver signal strength, and Timer 1 (if enabled). It also shows the numerical values of the output channels, 8 channels per page. Use the **[Roller]** to scroll thru the additional pages.

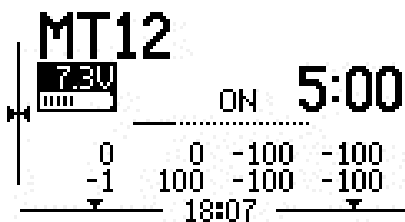

**Screen 4** - This view displays the model name, trim positions (if trims are enabled), clock, transmitter battery voltage, Drive mode, receiver signal strength, and Timer 1 (if enabled). It also shows the values of output channels as a bar graph, 8 channels per page. Use the **[Roller]** to scroll thru the additional pages.

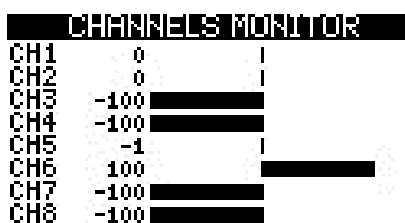

**Screen 5** - This view shows either the channel monitor or mixer monitor, 8 channels per page. Use the roller or dial to scroll thru the additional pages. Push the **[Roller]** button to switch between the channel monitor and mixer monitor.

Long pressing the **[Roller]** button from the main view screen will show a pop-up menu with the options below:

- View Notes - Displays the configured model checklist. This option is only visible if a valid model checklist file is in the Models folder.
- Reset - See Reset page.
- Statistics - See Statistics page.
- About - Displays the EdgeTX firmware version being used by the radio.

## 2.3 Reset



Selecting **Reset** from the pop-up menu will give you the following options:

**Reset flight** - When selected, this option:

- Resets all timers configured with a persistence setting of **Flight** to zero.
- Resets all discovered telemetry sensor values.
- Resets all logical switch states
- Triggers the same checks as loading the model - i.e. throttle position, switch state, is failsafe set check, display pre-flight checklist if configured, stuck keys test, etc.

**Reset timer 1 / 2 / 3** - Resets only the selected timer to zero regardless of the configured persistence setting.

**Reset telemetry** - This option resets all discovered telemetry sensor values

## 2.4. Statistics

The **Statistics** screen presents you with statistics regarding radio usage. All data is reset once the radio is powered off. The following information is provided:

- **SES** - The amount of time that the radio has been turned on.
- **THR** - The amount of time that the throttle has was above the 0% stick position.
- **TH%** - The amount of time that the throttle has was above the 50% stick position.
- **TM1/2/3** - The current values of Timer 1, Timer 2, and Timer 3.
- **Throttle Graph** - Shows the throttle percentage over time.

Long pressing the **[Roller]** or **[Dial]** button will reset the Statistics and Debug screens.

Pressing **[PAGE>]** will take you to the **Debug** screens.

Debug screen 1

```
00000000
Free mem    105988 bytes
Lua scripts [D]10 [I]170080
Tmix max    4.36ms (4ms)
Free stack  923/286/139
```

```
[ENTER] to reset.
```

The **Debug** screen provides data points used by the developers when debugging issues in the software. Most users will not find the information useful on this screen unless debugging issues with developers. The following debug information is provided.

- **Free mem** - Current free radio memory in bytes.
- **Lua scripts**
  - **[D]** - Maximum Lua duration in milliseconds.
  - **[I]** - Maximum Lua interval in milliseconds.
- **TMix max** - Maximum mixer task duration.
- **Free stack** - **[Menu]** / **[Mix]** / **[Audio]**
  - **[Menu]** - Minimum free stack memory for menu tasks.
  - **[Mix]** - Minimum free stack memory for mixer tasks.
  - **[Audio]** - Minimum free stack memory for audio tasks.
- **Tlm RX Err** - Number of received telemetry errors

## 2.5. Custom RGB LED Setup

The MT12 features RGB LEDs that are user programable via LUA scripts. A basic set of LUA scripts are included with the radio. You will be able to program any sequences of lights and effects you choose with a LUA script and can share your scripts with other users.

The LUA scripts for RBG effects are in the “\SCRIPTS\RGBLED” folder of the MT12 SD card.

To choose a colour or effect for your MT12 you can use one of the included LUA scripts, create your own LUA script or download a community made script and place it in the folder above.

To set one universal colour/effect turn on the RGB leds function in GLOBAL FUNCTIONS and choose a script.

```
GLOBAL FUNCTIONS 4/7
ON RGB leds green
---
---
---
---
```

To set a colour/effect for each different model turn on the RGB leds function in SPECIAL FUNCTIONS and choose a script.

```
SPECIAL FUNCTIONS 10/12
ON RGB leds green
---
---
---
---
```

### Advanced uses for RGB LEDs

Other than looking cool the RGB LEDs have some practical applications too! A combination of Logical Switches and special functions can be used to add extra functionality to the RGB lighting system.

For example, the RGB light colour can be linked to telemetry data from the battery of the model. A voltage threshold could be set to change the RGB colour from GREEN to RED when the battery reaches a specified voltage and the “POLICE” effect (flashing blue and red) when the model has not been powered up yet or Telemetry is lost.

First create these logical switches:

```
LOGICAL SWITCHES 9/12 LOGICAL SWITCH L01 LOGICAL SWITCH L02
L01 a<x ?RxBt6.8U --- Function a<x Function a>x
L02 a>x ?RxBt6.8U --- U1 ?RxBt U1 ?RxBt
L03 U2 6.8U U2 6.8U
L04 AND switch --- AND switch ---
L05 Duration --- Duration ---
L06 Delay 0.5 Delay 0.5
L07
```

Then setup these special functions.

```
SPECIAL FUNCTIONS 10/12
L01 RGB leds red
L02 RGB leds green
!TeleRGB leds Police
---
---
---
```

The possibilities are endless and can be customised to suit your needs.

## 2.6. Switch and Joystick Expansion Modules

The MT12 features interchangeable expansion modules and includes a dual switch expansion module and a 4 way Joystick module. You can choose the module you wish to install based on your own preferences.

### Hardware Installation

dual switch expansion module:



4 way Joystick module:



### Software Setup

Dual switch expansion module:

For the dual switch expansion module, press the SYS button and then Page > button to reach the HARDWARE page. Using the roller scroll down to S3 and S4. Set both S3 and S4 to "Switch". Next, scroll down to FL1 and FL2. Set FL1 to S3 and choose "2POS". Set FL2 to S4 and choose "2POS".

```

HARDWARE           6/7 HARDWARE           6/7
●S3 --- Switch      → 1FL1 S3 --- 2POS
●S4 --- Switch      → 1FL2 S4 --- 2POS
Switches
ISA --- 3POS
ISB --- Toggle
ISC --- Toggle
ISD --- Toggle
Batt. calib 7.11V
RTC Batt 3.09V
Check RTC 
Audio mute 
Internal RF
    
```

4 Way Joystick module:

For the 4 way Joystick plate, press the SYS button and then Page > button to reach the HARDWARE page. Using the roller scroll down to S3 and S4. Set S3 to Axis X and set S4 to Axis Y. Once this is set, please enter the calibrations screen and do a calibration (as you would for the wheel, trigger and knobs). Please note, at the time of writing this manual there is no visual display of the 4 way joy stick movement when calibrating, however the calibrations is taking please. Please move the 4 way joystick across both axis and complete the calibration.

```

HARDWARE           6/7
●S3 --- Axis X      →
●S4 --- Axis Y      →
Switches
ISA --- 3POS
ISB --- Toggle
ISC --- Toggle
ISD --- Toggle
    
```

## 3. Model Settings

### 3.1. Model Select

Pressing the [MDL] button from the Main view will open the **Model Select** screen.

```
Model Select          1/12
* 01 MT12
  02 CAR 2
  03 CAR 3
  04 CAR 4
  05
  06
  07
```

Use the [Roller] or [Dial] to scroll through the model slots.

Pressing [Enter] on an empty model slot will give you the following options:

- **Create Model** - This option creates a new model with the default configuration options.
- **Restore Model** - This option creates a new copy of a selected model that has been previously backed up. Pressing [Enter] on an occupied model slot that is not the active model (not marked with an asterix \*) will give you the following options:
  - **Select Model** - this option selects this model as the active model.
  - **Backup Model** - This option makes a copy of the model in the **Backup** folder on the SD Card.
  - **Copy Model** - This option makes an exact copy of the model and allows you to select which model slot it will be placed in.
  - **Move Model** - This option allows you to move the selected model to a different model slot.
  - **Delete Model** - This option deletes the selected model.

Pressing [Enter] on an occupied model slot that is the active model (marked with an asterix \*) will give you the following options:

- **Move Model** - This option allows you to move the selected model to a different model slot.
- **Copy Model** - This option makes an exact copy of the model and allows you to select which model slot it will be placed in.
- **Backup Model** - This option makes a copy of the model in the **Backup** folder on the SD Card.

### 3.2. Setup

```
Setup                2/12
Model name MT12
Timer1 ON TH+
Name ---
Start 05:00 Remain
Persist. OFF
Minute 
Countdown Silent
```

The **Setup** screen is where you start to configure your model. It contains the following settings:

**Name** - Name of the model. The maximum number of characters is 10.

- To edit the text, using the **[roller]** or **[dial]**, press the button, scroll to select the desired letter, then press the button again to move to the next space. To toggle between lower and upper case, long-press the button. Press the **[RTN]** button to exit out of text editing mode.

**Image** - Image displayed on the main view (only for radios with 212 x 64 displays).

*Image dimensions shall be 64 x 32 pixels, 16 bit, grayscale, .bmp file. The image must be stored in the **IMAGES** folder of the SD card.*

## Timers

**Timer 1/2/3** - There are 3 configurable timers in EdgeTX. The following configuration options will be displayed once the timer is no longer set to **OFF**:

### Timer 1 [Mode] [Switch]

**[Mode]**: The options include:

- **OFF**- The timer is not used
- **ON** - The timer runs all the time
- **Strt (Start)** -The timer starts once the configured switch is activated. After the time is started, the timer ignores the switch position.
- **THs (Throttle)** - The timer starts once the throttle is raised and the configured switch is activated. The timer will stop counting if either the throttle position is lowered back to the minimum value or the configured switch is deactivated.
- **TH% (Throttle %)** - The timer counts proportionally to the throttle. It counts in real-time at full throttle and half speed at 50% throttle.
- **THt (Throttle Start)** - The timer starts once the throttle is raised and the configured switch is activated. After starting, the timer ignores the throttle position and will keep counting unless the switch is deactivated.

**[Switch]**- *Select the switch that will trigger the timer to start. If no switch is selected, the timer will trigger based only on the configured mode. In addition to a switch, you can also select a trim, a telemetry source (triggered when telemetry data is received from that source), or physical activity (stick movement or button press) (labelled as **ACT**)*

Those items with a "!" mark in front of the trigger name mean that the condition is reversed. For example, "!SA-" means "when SA switch is not in middle/center position (= up or down)".

**Name**: Name of the timer

**Start**- The time used for the timer's advanced functions. The default value is 00:00 and when left as such, the timer operates like a stopwatch, counting upward until stopped. If a different time is entered in this box, then the additional field will appear next to the time with the options: **Remain** or **Elaps**.

If set to **Remain**, the counter will function like a countdown timer - counting down from the designated time to zero and then alerting the user. If set to **Elaps**, the timer functions like an alarm, counting up from zero until the designated time and then alerting the user.

**Persist (Persistence)**:

- **Off** - The timer value is reset when switching models or when the radio is turned off / on.
- **Flight** - The timer value is NOT reset when switching models or when the radio is turned off / on. The timer value is only reset when the **Reset flight** option is selected in the [Reset](#) menu.



- **Manual Reset** - The timer value is reset only when it is individually selected to be reset (example: Reset timer1) in the [Reset](#) menu.

**Minute (Minute Call)** - If selected, you will be notified every minute that passes as described in the **Count Down** option.

**Count Down:**

- **Silent** - No notification is given until the timer reaches zero. When it reaches zero, you will hear one beep.
- **Beeps** - The radio will beep every second starting at the time designated.
- **Voice** - The radio will count down by second starting at the time designated.
- **Haptic** -The radio will vibrate every second starting at the time designated.

```

SETUP                               2/12
E.Limits      [X]
E.Trims       [ ] [Reset]
Show Trims    No
Trim Step     Fine
  
```

Trims settings

**Trims**

**E.Limits (Extended Limits)** - When enabled, it increases the minimum and maximum range for the output values to -150 and 150. Extended limits are necessary if the full range of the control surface cannot be reached with standard limits.

**E. Trims) Extended Trims:** Increases the maximum trim adjustment value from ±25% to ±100%.

**Reset** - This resets all trim values to zero.

**Show trims:** When set to **Yes**, it will display the numerical trim value on the trim bar. When set to **CHANGE**, it will display the numerical value once the trim is no longer at zero.

**Trim Step:** Defines the amount of increase/decrease in trim when the trim switch is pressed.

- Course = 1.6%
- Medium = 0.8%
- Fine = 0.4%
- Extra Fine = 0.2%
- Exponential = 0.2% near the center and the step value increases exponentially as the distance from the center increases.

```

SETUP                               2/12
Throttle      ↑
T-Reverse     [ ]
T-Source      [ ] TH
T-Trim-Idle   [ ]
T-Trim-Sw     [ ] TH
  
```

Throttle Settings

## Throttle

The throttle related configuration options below are displayed in collapsible menu.

**T-Reverse:** When enabled, this option reverses the output direction of the configured throttle channel.

**T-Source:** The source that will be used for the throttle.

**T-Trim-Idle:** When enabled, the throttle trim will only affect the bottom portion of the throttle band.

For example, with **Trim idle only** enabled, the throttle stick at the lowest point might have a value of -80 and the center point will still be 0 and the highest point of 100. Without this enabled, the throttle stick at the lowest point might have a value of -80 however, the center point will be 20 and the highest point of 100.

**T-Trim-SW:** The trim switch that will be used to trim the throttle. It is possible to substitute the throttle trim switch with the aileron, rudder, or elevator trim switches.

```
SEUW 2/11
Pre-start Checks ↑
Checklist 
T-Warning 
Cust-Pos 
Pos. % 0
S-Warning H↑ L
Pot warn. OFF
Ctr Beep ST1234
ADC filter Global
```

Preflight Checks options

### Preflight Checks

Whenever a new model is loaded, EdgeTX will conduct pre-flight checks based on the checks that are configured on this page. If any of the checks are failed, EdgeTX will give the user an audio and visual warning that must be acknowledged before using the model. The following preflight checks below are displayed in collapsible menu.

**Checklist** - When this option is selected, the model notes file will be displayed when the model is loaded. A valid model notes file must be in the **Models** folder on the SD card. The model notes file must be a .txt file and must have the EXACT same name as the model it is for, for example: Mobula6.txt. The text in the file is up to the user.

**T-Warning** - When selected, the radio will check that the throttle is at the minimum value for the configured throttle source in the **T-Source** configuration option.

**Cust-Pos** - When this option is selected, the value designated in **POS.%** will be used for the T.Warning.

**Pos.%** - minimum value of the throttle for the throttle warning when **Cust-Pos** is enabled.

**S-Warning** - The section displays all the switches that are configured on the radio and allows you to select which position is the correct position for the switch state check. Selecting the switch will cycle through the available switch positions or turn the check off for the switch completely.

**Pot warn**- When activated, this option checks the position of the pots & sliders. There are three options - OFF, ON and AUTO. When ON or AUTO is selected, buttons for the available pots and sliders will appear. To enable the Pot warning for an individual Pot, select the pot with the [roller] or [dial] and click the button to highlight it. Highlighted pots are enabled.

- **OFF** - Pot and slider positions are not checked.
- **Manual** - Positions are checked against manually configured pot and slider positions. To manually set the check position, select **manual** the from menu, select the item that you want to set, and long-press the **[Enter]** button to set its current position for the check.

- **AUTO** - Positions are checked for pots and sliders and compared to the last automatically saved position before the radio was turned off or the model was changed.

**Ctr Beep** - Allows you to turn on/off the center beep function for the individual sticks, pots, and sliders by highlighting them with the **[roller]** or **[dial]** and pressing the button. When a switch is highlighted, the function is enabled.

**Glob. Funs** - When enabled, global functions programmed in the radio settings will apply to this model. When disabled, global functions will not apply to this model.

**ADC Filter** - Enables/disables the ADC filter for this model. The **global** option will take the value designated in the radio settings, which is *on* by default.

The ADC filter is a filter for the proportional channels (sticks, pots, sliders), smoothing out smaller fast movements that occur due to noise in the system electronics. Normally, this filter should be *disabled* for models with flight controllers.

### Internal / External RF

The configuration settings for both the Internal and External RF sections work the same. The only difference is that the **Internal RF** section is for configuring the built-in module and the **External RF** section is for configuring an RF module in the external module bay.

The configuration options are: **off** or the **module name** of the installed module as configured in the **Radio** settings. Configuration options are unique to each installed module. Please consult the manufacturer's documentation for configuration options.

Configuration options for the multi-protocol module are described here: <https://www.multi-module.org/using-the-module/protocol-options>

**Receiver number** - A receiver number is a user-assigned number for a model that is sent to the receiver when bound. Each model must have a unique receiver number. However, models using different protocols may have the same receiver number without issues. EdgeTX will inform you when a receiver number is unique or if it is already being used with a text above the number field.

If using the radio in gamepad mode, both internal and external RF modules should be turned off. This will result in increased performance when connected to a computer via USB.

### Trainer

**Trainer Mode** - The **Trainer Mode** option is where you can configure the CPPM passthrough mode and method. When enabled, this allows the CPPM signals from a radio in **Slave** mode to be passed through to another radio in Master mode which will then pass the signal to the model it is connected to. CPPM passthrough can be used for several different use cases, such as: connecting a head tracker, Instructor / Student training mode, and controlling complex models that require more stick inputs than available on a standard transmitter.

**Master mode** - This is the mode for the radio that will be connected to the model. This radio also shall configure the special/global function (Trainer) to activate the passthrough mode. When the passthrough mode is activated, the CPPM signals from the radio in **Slave mode** will be sent to the model for control.

**Slave mode** - This is the mode for the radio that will pass its CPPM values to the radio in **Master mode**, which are then sent to the model.

Below are the possible configuration options:

- **Off** - Trainer mode is not used for this model.
- **Master / Jack** - Master mode using a cable connection.

- **Slave / Jack** - Slave mode using a cable connection.
  - **Channel Range** - This is the range of channels that will be sent to the radio in Master mode. Channel 10 is the recommended last channel to use.
  - **PPM Frame** - The first field is the length of the PPM frame. The second field is the stop length/delay between pulses. The dropdown is to select the polarity of the signal. The frame length is automatically adjusted to the correct value when the number of transmitted channels is changed. However, this automatically assigned value can be manual changed. **Note:** *In most cases, the default setting does not need to be changed.*
- **Master / Bluetooth** - Master mode using a Bluetooth connection (if installed in radio).
- **Slave / Bluetooth** - Slave mode using a Bluetooth connection (if installed in radio).
- **Master / Multi** - Master mode using an additional externally mounted Multi-protocol module for the connection. For more information on this setup, see [Set-up wireless trainer with a Multi -protocol module](#)

```

SETUP                               2/12
Radio Menu Tabs
GLOBAL FUNCTIONS Global
TRAINER Global
Model Menu Tabs
DRIVE MODES Global
CURVES Global
LOGICAL SWITCHES Global
SPECIAL FUNCTIONS Global
TELEMETRY Global
  
```

Enabled Features options

### Enabled Features

The **Enabled Features** section allows you to configure which pages are visible in the selected model's radio setup and model settings area of EdgeTX. The page names are displayed in a collapsible menu with the following configurable options:

- **Global** - When selected, the tab will take the global value configured in the **Enabled Features** area in **Radio Setup**. The configured global value will display next to the option.
- **On** - When selected, this tab will be visible when this model is loaded.
- **Off** - When selected, this tab will not be visible when this model is loaded.

**Note:** Turning off a tab only hides the tab and does not change the items already configured in that tab. For example, if you configure a special function and then turn off the special functions tab, the special function will still work as configured.

**EXCEPTION:** Turning off the Global Functions tab will disable configured global functions for that model.

```

SETUP                               2/12
Mode Master/SBUS
Enabled Features ↓
USB Joystick
Mode Advanced
If. mode Joystick
Circ. cut None
[Channel Settings]
  
```

USB Joystick advanced mode settings

## USB Joystick

The **USB Joystick** has two possible modes, **Classic** and **Advanced**.

In **Classic mode**, the radio's configured output channels will be sent to the target device in numerical order and mapped to the device's preconfigured USB controller axes and buttons. Below is the default channel mapping for Microsoft Windows.

- Ch1 - X Axis
- Ch 2 - Y Axis
- Ch 3 - Z Axis
- Ch4 - X Rotation
- Ch 5 - Y Rotation
- Ch 6 - Z Rotation
- Ch 7 - Dial
- Ch 8 - Slider
- CH 9 - Ch 32 - Buttons 1 - 24

In **Advanced mode** you can configure the following additional options:

**If mode (Interface mode):** This indicates to the target device (the device you are connecting your transmitter to) what type of device you are connecting. The options are **Joystick**, **Gamepad**, **MultiAxis**.

**Note:** Currently there is a limitation in MS Windows that may limit your transmitter to being only detected only as a Joystick, regardless of what is selected in this option. In MacOS, Linux and Android, this functions properly.

**Circular cutout:** For axis pairs (X-Y, Z-rX): By default, the range of the axis pairs is a rectangular area. With this option, the axis will be limited to a circular area (like gamepad controllers commonly are). Options are : **None** or **X-Y, Z-rX** or **X-Y, Rx-Ry**

### Channel Settings

**Mode:** For each output channel, you can select the mode that you want to use for that channel. The available options are **None**, **Btn**, **Axis**, **Sim**.

**None** - Channel is not used

```
USB Joystick CH1 8
Mode Btn
Inversion 
Button Mode Normal
Positions Push
Button no. 0
```

Button mode options for a selected channel

**Btn** - Channel is used to simulate a button. Configuration options include:

- **Inversion** - Inverts the output channel signal. Options are: **On / Off**
- **Button Mode** -

- **Normal** - Each position of a multiposition switch is represented by a button. The current switch state is represented by a continuous button press.
- **Pulse** - Similar to "Normal" mode. However, instead of continuous button press it is represented by a short button press.
- **SWEmu** - The toggle switch emulations a push button. The first press turns the virtual button on, the second press turns it off.
- **Delta** - The change of the output channel is represented by 2 buttons. While the output value is decreasing, the first button is pressed. When the output value is increasing, the second button is pressed. If there is no change, then no buttons will be pressed.
- **Companion** - This option should be selected when using your transmitter to control the simulator in EdgeTX Companion. It allows the multi-position switches to function properly in the simulator.
- **Positions** - The type of button that will be simulated.
  - **Push** - will only map to one button
  - **2POS - 8 POS** - will map to the number of buttons that the switch has (ex: 3POS will map to 3 buttons).
- **Button No:** The button number that the output will be mapped to and sent to the target device as.

```

USB Joystick: CH1      8
Mode          Axis
Inversion     
Axis         X
  
```

Axis mode options for a selected channel

**Axis** - The channel is used to simulate an axis and will be mapped to one of the target device's default axes.

- Axis options are: X, Y, Z, rotX (rotation x), rotY, rotZ

```

USB Joystick: CH1      8
Mode          Sim
Inversion     
Sim axis      Ail
  
```

Sim mode options for selected channel

**Sim** - The channel is used to simulate a common sim axis and it will be listed on the target device as the selected option (ex: Thr)

- Sim Axis options are: **Ail, Ele, Rud, Thr**

### 3.2. Drive Modes

Drive modes allow you to have different trim settings for each Drive mode. Once multiple Drive modes are configured, you can adjust the trim settings in each Drive mode without affecting the trim settings in other Drive modes (unless they are configured to do so). There are nine possible Drive modes, with Drive mode 0 being the default mode.

```

DRIVE MODES          4/12
DM0                  :0:0:0:0
DM1      ---        :0:0:0:0
DM2      ---        :0:0:0:0
DM3      ---        :0:0:0:0
DM4      ---        :0:0:0:0
DM5      ---        :0:0:0:0
DM6      ---        :0:0:0:0
DM3      ---        :0:0:0:0
DM4      ---        :0:0:0:0
DM5      ---        :0:0:0:0
DM6      ---        :0:0:0:0
DM7      ---        :0:0:0:0
DM8      ---        :0:0:0:0
Check DM0 trims
  
```

Drive modes Overview screen

The Drive modes Overview screen shows an overview of the configured Drive modes. The information below is displayed for each Drive mode row:

- Drive mode
- Drive mode Name
- Switch
- Trim settings (RETA)

**Check FM Trims:** When check FM trim is pressed, the trims for the current Drive mode are temporarily disabled. This is used to test the impact of the current Drive mode’s trims on the outputs.

```

DRIVE MODE          DM1
Mode name          ---
Switch             ---
Trims              :0:0:0:0
                  :0
Fade in            0.0
Fade out           0.0
Global variables
G1                DM0      0
G2                DM0      0
G3                DM0      0
G4                DM0      0
G5                DM0      0
G6                DM0      0
G7                DM0      0
  
```

Drive mode Configuration screen

Selecting a Drive mode from the overview screen will open the configuration page, which has the following options:

**Name:** The custom name for the Drive mode. If configured, this name will be shown on the upper left position of the main screen next to the battery voltage.

**Switch:** The trigger to enable that Drive mode. It can be a switch, pot, telemetry, trim or logical switch.

**Trims** - To configure the trims, select the trim that you want to configure (each column is one trim). Then scroll to select the Drive mode (**0-8**) that will provide the initial trim value and modifier (= or +). Select -- to disable the trim.

**Modifier** - there are two possible value modifiers = and +. The = modifier uses the trim value directly from the selected Drive mode. The + modifier uses the trim value from the selected Drive mode and then adds the trim value from the Drive mode you are configuring.

*Example 1:* If you are configuring FM1 and set the value to =0, FM1 will have the trim value of the current value of the same trim in FM0. In this case, changes made to the trim in FM1 will also affect the trim in FM0 and vice-versa.

*Example 2:* If you are configuring FM1 and set the value to +0, FM1 will have the trim value of the same trim in FM0, plus any trim changes made while in FM1. In this case, changes made to the trim in FM1 do not affect the trim in FM0. However, changes to trim values FM0 will affect trim values in FM1.

**Fade in:** Gradually change the trim value when this Drive mode is enabled. Specify the time in seconds (0.0 - 25.0) until the value change is completed.

**Fade out:** Gradually change the trim value when this Drive mode is disabled. Specify the time in seconds (0.0 - 25.0) until the value change is completed.

If the trim is turned off (--) on the setup page, you will not be able to adjust it at all on the main view screen.

## Global Variables

Global variables are variables whose values are shared across all the configuration screens of a model. Their values can be used in weights, offsets, differential, expo settings, outputs, and in logical switch comparisons. The bottom portion of the Drive mode configuration screen shows an overview of each global variable for the selected Drive mode. For each global variable row, the following information is displayed:

- **Global Variable Number:** Displayed as **GV(1-9)**
- **Global Variable Name:** User-defined name for the global variable - up to three characters.
- **Mode:** Where the value of the global variable comes from. Options are:
  - **Own:** the global variable value for the selected Drive mode is manually defined in the **Value** text field.
  - **FM(1-9)** - global variable value for the selected Drive mode is inherited from the Drive mode defined in the drop-down.
- **Value:** The current value of the global variable.

You can edit the value of the global variable by changing the value in the value text field. Selecting the global variable number will open the global variable configuration screen will give you the following options:



```

GVARS 61
Name      ---
Unit      -
Precision 0.--
Min       -1024
Max       1024
POPUP     
DMO       0

```

Global Variables configuration screen

- **Name** - Name for the global variable. Three characters are allowed.
- **Unit** - (optional) Allows you to add a % label to the displayed values when selected. It DOES NOT affect how the values are calculated.
- **Precision** - Allows you to select the number precision options whole numbers (**0.-**) and decimal (**0.0**). The default value is **0.-**
- **Min** - Defines the minimum that is allowed for the global variable.
- **Max** - Defines the maximum value that is allowed for the global variable.
- **Popup** - When enabled, a pop-up window will be displayed on the main screen when the value of this global variable changes during normal use.
- **FM1 -> FM8** - Allows you to select the global variable inheritance for the Drive mode. **Long press** the field to switch between **Own** and **Inheritance** mode. In **Own** mode, you can define the global variable value for the selected Drive mode. In **Inheritance** mode, you can select the Drive mode that the global variable will inherit the value from.

### 3.3. Fail Safe

#### 4in1 Multi-Protocol Failsafe

Failsafe settings determine what the receiver will do if radio communication is lost. The receiver is configured using settings sent from the radio as part of the radio transmission.

Configuring failsafe settings ensures that the receiver behaves in an expected way if radio communications between the radio and receiver are lost, for example by reducing throttle to -100%, or activating a return-to-home (RTH or RTL) function in the flight controller.

Different receiver types require different failsafe procedures, further information: <https://www.multi-module.org/using-the-module/protocol-options#failsafe>

```

Setup 2/12
Internal RF
Mode MULTI
Type FrSky X
Subtype D16
Status V1.3.33 AETR
Ch. Range CH1- 16
Receiver 00 [Bnd] [Rng]
Frequency 0 RSSI (0)
Bind Ch. 
No Telem 
Low Power 
Failsafe No pulses

```

Failsafe Mode	Receiver Behaviour
Not Set	Failsafe not configured.
Hold	Hold the last values received before radio communication was lost.
Custom	Use the radio to configure specific values for the receiver to use.
No Pulses	All channels go to their minimum values.
Receiver	Use values configured on the receiver using the receiver's configured failsafe settings.

### ExpressLRS Fail safe

Once the receiver is bound and the model has been correctly setup on the radio open the ExpressLRS LUA script by pressing the [SYS] Button and using the roller to run the ExpressLRS script.

Once the script is loaded use the roller to scroll to "> Other Devices" to open the receiver settings. Scroll to "[Set Failsafe Pos]" and press enter on the roller. The position of the trigger, wheel, knobs, switches, joystick will now be recorded as the failsafe position on the receiver.

```

RadioMaster Zorro0/250 C RM ER8
> HiFi Connectivity > Output Mapping
> Backpack          [Set Failsafe Pos]
  [BLE Joystick]    Model Id      Off
  [Bind]            3.3.0        ae9df3
3.0.1 ISM2G4 2470Fc
> Other Devices    > Other Devices
                    [-----EXIT-----]

```



### 3.4. Reversing a Servo

To change the direction of a servo movement, press the [MDL] button. Press [Page>] until you reach the "OUTPUTS" screen. Select the channel that you wish to reverse the servo out put on with the roller. Press enter and select "Edit". Use the roller to scroll to "Direction" and select "INV". The servo output is now reversed from its standard output.

```

OUTPUTS 1500us 6/11
CH1 0.0 -100 100 → --- Δ
CH2 0.0 -100 100 → --- Δ
CH3 0.0 -100 100 → --- Δ
CH4 0.0 -100 100 → --- Δ
CH5 0.0 -100 100 → --- Δ
CH6 0.0 -100 100 → --- Δ
CH7 0.0 -100 100 → --- Δ

OUTPUTS CH2 1500us
Name ---
Subtrim 0.0
Min -100.0
Max 100.0
Direction INV
Curve ---
PPM Center 1500

```

### 3.5. EXPO

To set EXPO on a channel, press the [MDL] button then press [Page>] until you reach the "INPUTS". Use the roller to select the channel you wish to add EXPO to. Press enter and select "Edit" and use the roller to select Expo. Enter the desired amount of Expo required, in the example below, 25 points of Expo has been entered. Exit from this screen and "E25" will show confirming this channel now has 25 points of Expo set.

```

INPUTS 8/64 4/11
ETh 100 LTH ---
Est 100 LSI ---
ESa 100 LSH ---
ESb 100 LSB ---
E05 100 S1 ---
E06 100 S2 ---
E07 100 LSC ---

INPUTS Est -0.2
Source LST -0.2
Weight 100
Offset 0
Curve ---
Expo 25
Mode ---
012345678

INPUTS 8/64 4/11
ETh 100 LTH ---
Est 100 LSI E25 ---
ESa 100 LSH ---
ESb 100 LSB ---
E05 100 S1 ---
E06 100 S2 ---
E07 100 LSC ---

```

### 3.6. Dual Rates

To set up a dual rate on a switch press the [MDL] Button and then press [Page>] until you reach the “INPUTS” screen. On the Channel you wish to set a dual rate on press and hold enter on the roller button and choose “Insert before”. In this example we will setup a Dual rate on the SA switch with a rate of 60% and 80% on the “ST” aka steering channel. First select the “Weight” Option and enter the amount of rate you desire, in the example below we will set 60%. Then scroll to “Switch” and press enter to select a switch then move the SA switch in to the first position. Press [RTN] to exit. Repeat the process on the 2<sup>nd</sup> line of the “ST” channel in the “INPUTS” screen and enter a weight, in this case we will enter 80%. Select the position of the SA switch for the 2<sup>nd</sup> rate. Press [RTN] when done. You will now have dual rates of 60% and 80%. You may also add expo to both rates with the method above.

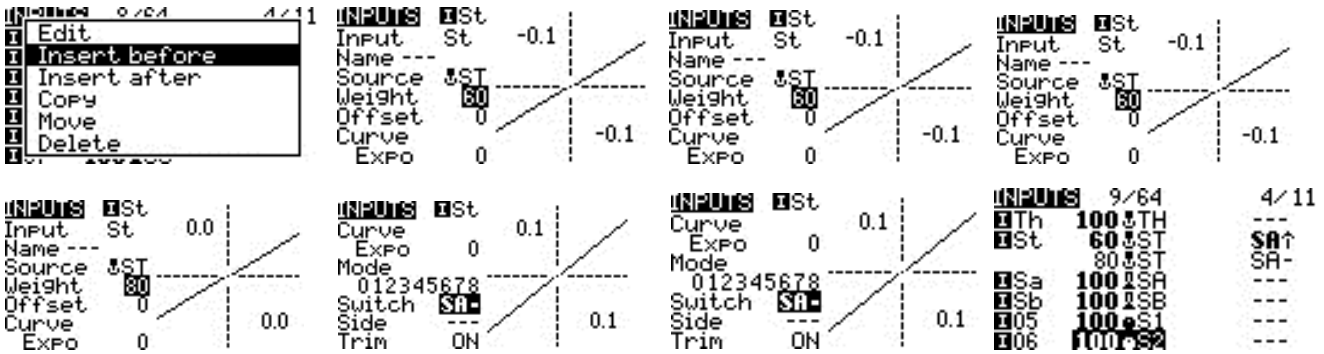

You may also add expo to both rates with the method above in section 3.5.

### 3.7. End points

To change the end points of a channel, press the [MDL] button. Press [Page>] until you reach the “OUTPUTS” screen. Select the channel that you wish to change the end point on with the roller. Press enter and select “Edit”. Use the roller to scroll to select “Min” or “Max” and change the value to your requirement. In the example below, the end point of both Min and Max has been reduce to 85 points.

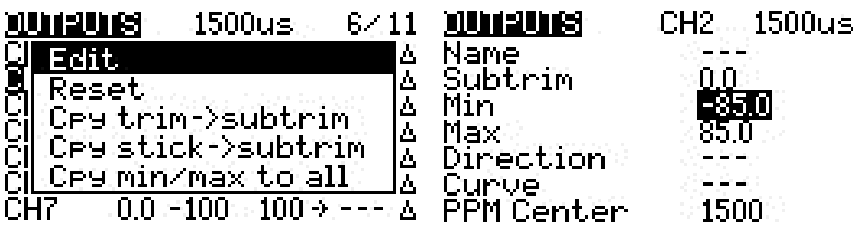

## Inputs, Mixes & Outputs

To be able to support many different types of radio transmitters, EdgeTX uses a generic control data flow that can be applied to any radio transmitter. In this data flow, any of the radio's physical controls (sticks, switches, sliders, pots) can be mapped to an input in the software. These inputs can be directly assigned or combined with other inputs into a single mix. These mixes can be modified by applying weights, offsets, and curves and are then assigned a channel for output. Final adjustments to the control data are made (including subtrims, curves, endpoint, and center values) before finally sending the control data to the RF module. The flowchart below depicts a visual summary of this control data flow. Detailed information about the flow is provided in the following sections Inputs, Mixes, and Outputs.

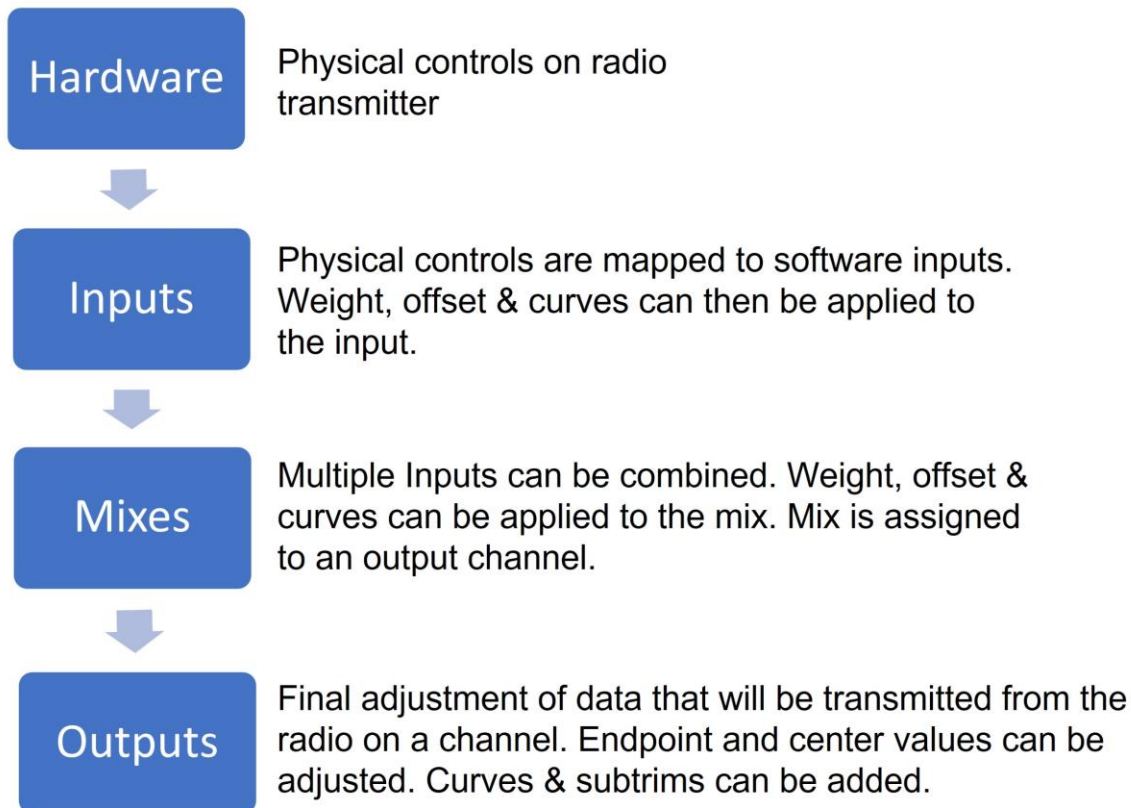

### 3.5. Inputs

The **Inputs** screen is where you map your physical radio controls (for example: sticks, sliders, and pots) to a software input to be used by the radio. After the control has been mapped, it is then possible to apply modifiers to the inputs, such as a weight, offset or curve, which will then be applied anywhere that input is used. Although it is possible to also assign switches as inputs, it is normally not needed as switch outputs seldomly need to be modified by a weight, offset or curve. By default, EdgeTX will automatically map your controller sticks to Aileron, Elevator, Throttle, Rudder based on the default channel order defined in **Radio Setup**.

Your input channels may default to a different order based on the settings defined in **Radio Setup**.

The Inputs section is also commonly referred to as "**Dual Rates**" as it was previously called this in earlier versions of OpenTX.

```

INPUTS  8/64          5/12
[Th  100  &TH  ---
[St  100  &S1  ---
[Sa  100  &SA  ---
[Sb  100  &SB  ---
[05  100  &S1  ---
[06  100  &S2  ---
[07  100  &SC  ---

```

Inputs screen

The inputs screen shows you an overview of your configured inputs. Each row represents an input line and displays the following information from left to right: Input name, weight, activation switch, line name. These items are described in the [Input configuration page](#) area below.

Selecting an existing input line and pressing **[Enter]** will toggle between **Copy/Paste** mode and **Move** mode. In **Copy/Paste** mode, a copy of the input line is made which can be pasted in the desired input line. In **Move** mode, the selected input can be moved to a different line. Press the **[Return]** button to exit this mode.

Selecting an empty input line and pressing **[Enter]** will create a new input and open the input configuration page.

Selecting an existing input line and long-pressing **[Enter]** will give you the following options:

- **Edit** - opens the input configuration page for that input line.
- **Insert before** - Inserts a new input line before the selected input.
- **Insert after** - Inserts a new input line after the selected input.
- **Copy** - copies the selected input line.
- **Move** - selects the input line to be moved. The input is moved using one of the paste commands after a new line is selected (i.e. cut & paste).
- **Delete** - deletes the selected input line.
- **Paste before** - pastes the copied or moved input line before the selected input line.
- **Paste after** - pastes the copied or moved input line before the selected input line.

```

INPUTS  [Th
Input   [Th  0.0
Name ---
Source  &TH
Weight  100
Offset  0
Curve   0.0
Expo    0

```

Input Configuration Page

### 3.6. Input configuration page

The input configuration page allows you to edit the input configuration parameters. To the right of the configuration parameters, you can see a live graph that shows how your configuration options will affect the slope of the input.

**Input Name** - Name for the input. Three characters are possible.

**Line Name** - Name of the individual line in the input. Multiple physical inputs can be mapped to one input by adding an additional input line under the input.

**Source** - The physical control used for the input. In addition to physical controls, you can also specify MAX (always returns 100), cyclics, trim switches, channel values and more. Moving the physical control after the source has been selected will automatically map it to that input.

**Weight** - Percentage value of the stick travel to use (often referred to as "rates"). Long-pressing here will switch from numerical value to a global variable.

**Offset** - The value added to or subtracted from the input source.

**Curve** - Specifies the type of curve that will be used. The following curve options exist:

- **Diff** - Multiplies only the range above or below the middle (0) by the specified %.
- **Expo** -The input value is changed exponentially. Increasing the % will result in a gentle slope near the middle(0). Decreasing the % will result in a steep slope near the middle (0). With a % of 0, the slope will be linear.
- **FUNC-**

Function	Slope Behavior
---	The slope will be linear.
X>0	The range below the middle (0) is always 0. Above the middle (0), the slope is linear.
X<0	The range above the middle (0) is always 0. Below the middle (0), the slope is linear.
X	The range above the middle (0), the reaction is linear. The sign is inverted in the range below the middle (0). The curve draws a V-shaped graph.
f>0	The range above the middle (0) is always +100. The range below the middle (0) is always 0. The output value will always be either 0 or +100.
f<0	The range above the middle (0) is always 0. The range below the middle (0) is always -100. The output value will always be either 0 or -100.
f	The range above the middle (0) is always +100. The range below the middle (0) is always -100. The output value will always be either +100 or -100.

- **Cstm** - assigns a custom-defined curve. See [Curves](#) for more information about custom-defined curves.

Values for weight, offset and curve % can also be defined by a configured global values. Selecting the **GV** button will display a list of configured global values to select from.

**Modes** - Specifies which flight modes this input is active for.

**Switch** - The switch that activates the input line. If no switches are defined, then it is always active.

**Side** - Specifies the input range for which this line setting is valid. If you select ---, it will be valid in the entire range of Source values. If you select **x>0**, it will be valid in the upper half of the value of Source. If you select **x<0**, it will be valid in the lower half of the value of Source.

**Trim** - Specifies whether or not to include the trim values in this input. Additionally, you can select a different trim to use for this input.

### 3.7. Mixes

The **Mixes** screen is where several Inputs can be combined into one "Channel Mix". These mixes are then assigned to a radio channel for output. This is also the place where switches, knobs or sliders are assigned to a channel for output. Similar to the Input section, it is also possible to assign a weight, offset or curve to a channel mix.

```

MIXES 8/64          6/12
CH1 100 Th
CH2 100 St
CH3 100 SA
CH4 100 SB
CH5 100 05
CH6 100 06
CH7 100 SC
Mixes Page
  
```

The **Mixes** screen shows you an overview of your configured mixes. Each row represents a mixer line and displays the following information from left to right: channel, weight, input, mix name switch. These items are described in the [Mixes configuration options](#) area below.

Selecting an empty mix line and pressing **[Enter]** will create a new mix and open the mixes configuration page.

Selecting an existing mix line and pressing **[Enter]** will toggle between **Copy/Paste** mode and **Move** mode. In **Copy/Paste** mode, a copy of the mix line is made, which can be pasted into the desired channel or mix line. In **Move** mode, the selected mix can be moved to a different channel. Press the **[Return]** button to exit this mode.

Selecting an existing mix line and long-pressing **[Enter]** will give you the following options:

- **Edit** - opens the mixes configuration page for that mix line.
- **Insert before** - Inserts a new mix line before the selected mix.
- **Insert after** - Inserts a new mix line after the selected mix.
- **Copy** - copies the selected mix line.
- **Move** - selects the mix line to be moved.
- **Delete** - deletes the selected mix line.

```

MIXES CH2
Mix name  ---
Source    1st
Weight    100 -100 100
Offset    0      .....
Trim      [x]
Curve     Diff 0
Mode      012345678
Switch    ---
Warning   OFF
Multiplex Add
Delay up  0.0
Delay dn  0.0
Slow up   0.0
Slow dn   000
Mixes Configuration Screen
  
```

#### Mixes Configuration Options

The right portion of the mixes configuration page contains a graph that shows the channel range for the mix. When the **edit** option is selected for a mix, the following configuration options are available:

- **Mix Name** - Name of the mix (optional). Up to 6 characters are allowed.

- **Source** - The source for the mix. In addition to inputs, you can select sticks, pots, sliders, trims, physical and logical switches, heli mixer outputs, trainer import channel values, and other channels. (Note Heli functions are not available on the MT12)
- **Weight**- Percentage of the source value to use. Long-pressing here will switch from numerical value to a global variable.
- **Offset** - The value added to or subtracted from the source.
- **Trim** - Specifies whether or not to include the trim values in this mix. For the trim values to be included, the trim field for the relevant input must also be enabled on **INPUTS** screen.
- **Curve** - Specifies the type of curve that will be used. See the **curve** section on the [Inputs](#) page for detailed explanations of the different curve types.
- **Switch** - The physical switch that activates this mix line (optional). If no switch is selected, then the mix will be active by default.
- **Warning** -when selected, the radio will beep when this mix is active. You can choose from OFF or beep patterns 1, 2, 3.
- **Multiplex** - The multiplex setting defines how the current mixer line interacts with the others on the same channel. **Add** will add its output to them, **Multiply** will multiply the result of the lines above it, and **Replace** will replace anything that was done before it with its output.
- **Modes** - Specifies which flight modes this mix is active for. Visible modes are active.
- **Delay up** - Creates a time delay in seconds between when the source value increases and when it is output.
- **Delay down** - Creates a time delay in seconds between when the source value decreases and when it is output.
- **Slow up** - Adjusts the transition speed for source value increases. Specify the time to transition from -100% to + 100% in seconds. You can specify a range from 0.0 seconds to 25.0 seconds.
- **Slow down** - Adjusts the transition speed for source value decreases. Specify the time to transition from - 100% to + 100% in seconds. You can specify a range from 0.0 seconds to 25.0 seconds.

### 3.8. Outputs

The **Outputs** screen is where final adjustments to the control data are made (including subtrims, curves, endpoint, and center values) before finally sending the control data to the RF module. This is where the channel center, limits (to prevent servo binding) and output direction are set.

A **Trim** is a temporary adjustment to a flight control normally done while in operation with a trim switch. A **Subtrim** is a semi-permanent adjustment to a flight control that is normally configured when setting up the model in the output settings.

```

OUTPUTS      1502us   7/12
CH1      0.0 -100  100 → --- Δ
CH2      0.0 -100  100 → --- Δ
CH3      0.0 -100  100 → --- Δ
CH4      0.0 -100  100 → --- Δ
CH5      0.0 -100  100 → --- Δ
CH6      0.0 -100  100 → --- Δ
CH7      0.0 -100  100 → --- Δ

```

Outputs screen

The output screen shows all the output channels. For each output line, it displays the values for the subtrim, minimum and maximum limits, direction, curve, and subtrim mode. After the last output line is the option **Trims=>Subtrims**. When this option is selected, it adds the current trim value to the subtrim value for each configured output. The trim value is then reset to zero.

Selecting an output line will give you the following options:

- **Edit** - Opens the output configuration screen.



- **Reset** - Sets the subtrim value back to zero. The trim value is not changed.
- **Cpy Trims -> Subtrim** - Adds the current trim value to the subtrim value. The trim value is not changed.
- **Cpy Sticks -> Subtrim** - Adds the current value of the stick deflection as the subtrim value.
- **Cpy min/max to all** - Copies the settings in Min / Max field of selected channel to all other channels.

```

OUTPUTS      CH1  1502us
Name           ---
Subtrim        0.0
Min            -100.0
Max            100.0
Direction      ---
Curve          ---
PPM Center     1500
Outputs Configuration page

```

The output configuration screen has the following configuration options:

- **Name** - Name for the Output up to 6 characters.
- **Subtrim** - The subtrim value (max 100). It can also be set to a global variable by long-pressing the **[Enter]** button to switch to GV Mode and then selecting the desire global variable.
- **Min** - Minimum output limit. Commonly used to prevent servo binding on models that use servos for the control surfaces.
- **Max** - Maximum output limit. Commonly used to prevent servo binding on models that use servos for the control surfaces.
- **Direction**- Select --- for normal output value, **INV** if you want to invert the output value.
- **Curve** - Specify the custom curve (in any) that you want to use for this output. See **Curves** for more information about custom-defined curves.
- **PPM Center** - Specify the pulse-width value for the center value of the output channel (between 1000 - 2000). Changing this will shift the entire output range, including upper and lower limits.
- **Subtrim mode** - Defines how the subtrim value affects the min/max output values. There are two options:
  - **△ (Center Only)** - Only the center value shifts. The upper and lower limits do not change. The reaction of the stick differs between the upper half and the lower half from midpoint.
  - **= Symmetrical** - Both the upper and lower limits will shift according to the shift of the center value. The reaction of the stick is the same on both sides of the midpoint.

## 4. Curves

### 5.1 Setting curves

The **Curves** screen allows you to define custom curves to use in the Inputs, Mixes, or Output screens. The curves screen will show the configured custom curves, with a graphical representation of each curve.

```

CURVES
CU1  Es1
CU2  ---
CU3  ---
CU4  ---
CU5  ---
CU6  ---
CU7  ---

```

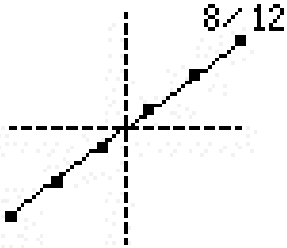

Curves Screen

Selecting one of the curves or empty curve slots will open the configuration page for that curve.

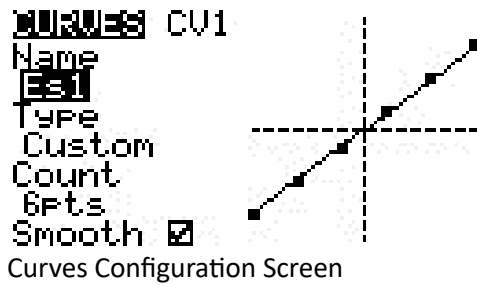

### Curves Configuration

The curve configuration screen has the following configurable options:

- **Name** - Name for the curve. Only 3 characters are possible.
- **Type** - Type of curve: Options are **Standard** and **Custom**
  - **Standard** - Horizontal axis points are fixed values based on the number of points. Vertical axis points are adjustable.
  - **Custom** - Both horizontal and vertical axes are adjustable.
- **Count** - number of points in the curve. Press the **[Enter]** button to modify the number of points. Long-pressing the **[Enter]** button will give the following additional options:
  - **Preset** - Allows you to set the curve to one of the preset slope values (-45 to 45 degrees in 15 degree increments). The curve will have 5 points, and smoothing is not enabled by default.
  - **Mirror** - Mirrors the selected curve.
  - **Clear** - Clears all curve values from the selected curve.
- **Smooth** - When enabled, connects the points with curved lines instead of straight lines.

### Editing Curve Points

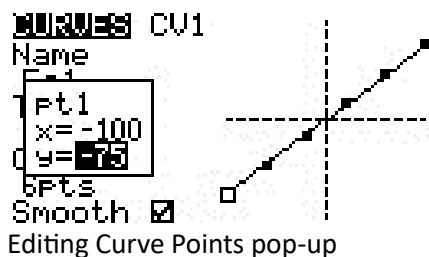

After the last configuration option (Smooth), you will automatically begin to scroll through the configured points on the curve. To change the values of the points, press the **[Enter]** button and then adjust the values as desired. For **Standard** curves, you will only be able to adjust the Y value. For **Custom** curves, you can adjust both the X and Y values.

## 5. Logical Switches

### 6.1. Using Logical Switches

Logical Switches are virtual two-position switches whose values (ON/OFF or +100/-100) are based on the evaluation (true/false) of a defined logical expression. Once configured, logical switches can be used anywhere in EdgeTX that a physical switch can be defined.

The **Logical Switches** page shows you all the configured logical switches as well as an overview of their configured options.

```

LOGICAL SWITCHES 9/12
L01 a<x Batt 6.8 SA↑
L02
L03
L04
L05
L06
L07

```

Logical Switches Screen

Selecting a logic switch will give you the following options:

- **Edit** - Opens the Logical Switches configuration page for the selected logical switch.
- **Copy** - Copies the selected logical switch
- **Paste** - Pastes a copied logical switch onto the selected logical switch. Note: it will overwrite the selected logical switch.
- **Clear** - Deletes all configuration options for the selected logical switch.

```

LOGICAL SWITCH L01
Function a<x
V1 Batt
V2 6.8
AND switch SA↑
Duration ---
Delay 0.5

```

Logical Switches Configuration Screen

After selecting to edit a logical switch, you will have the following configuration options:

- **Func** - The logical function that you want to use. See [Logical Switch Functions](#) below for a description of the possible functions you can use.
- **V1** - The first variable in the expression to evaluate.
- **V2** -The second variable in the expression to evaluate.
- **AND switch** - Switch that must be active to allow the logical switch to be evaluated for activation.
- **Duration** - The duration that the logical switch will remain active (true) once meeting activation criteria.
- **Delay** - Delay between when the activation criteria for the logical switch has been met and when the logical switch changes to the activated state (true).

#### Logical Switch Functions

In the expression, a and b represent sources (sticks, switches, etc.), and x represents the constants (values) to be compared.

## 6. Special Functions

### 7.1. Configuring Special Functions

The **Special Functions** section is where you can configure the special functions that are included in EdgeTX. These special functions add additional functionality beyond normal model controls, such as enabling trainer mode, playing a sound, adjusting the radio backlight, adjusting radio volume, etc. On the special functions screen, you will see all configured special functions as well as some of the configured options such as function name, activation switch, if the function is enabled, and other configuration options.

```

SPECIAL FUNCTIONS 10/12
ON RGB leds Police
L01 Play Sound Wrn1 1
FL2↓Screenshot
---
```

## Special Functions

### Configuring Special Functions

To configure a special function, select the desired special function row and press the **[Enter]** button. Then, scroll with the **[Roller]** to select the attribute that you want to edit (it will be highlighted) and press the **[Enter]** button to edit it (it will now be blinking). Edit the option by scrolling with the **[Roller]** and pressing the **[Enter]** button to select the desired option. Once all the options are configured, press the **[Return]** button to exit out of editing mode for the special function.

All special functions have the configuration options below. Additional options may be added based on the selected function. See the **Functions** section below for these additional options.

- **Trigger** - The switch or trigger that will make the special function active. Long pressing on this section will allow you to quickly select the category of the switch and filter the results. You can select the following filters: **Switches, Trims, Logical Switches, Other** and **Invert**
- **Function** - The function that will be used. See below for function descriptions.
- **Enable** - Toggle on/off to enable the function. To be able to activate the special function by a switch, it must be enabled. This option is usually the last option listed as a checkbox on the far right of the screen. Disabled special functions will not function regardless of the configured switch position.

### Functions

Below are all the available functions in EdgeTX, what they do, as well as what additional configuration options that will be shown when the function is selected.

**Override** (Channel Override) - Overrides the defined channel with the defined value.

- **CH** - Channel to be overridden
- **Value** - Value to replace the normal channel value. (Range -100 to +100)

**Trainer** - Enables trainer mode.

- **Value** - Specifies which controls will be given over to the student. Options include **Sticks** (all sticks), **Rud** (Rudder), **Ele** (Elevator), **Thr** (Throttle), **Ail** (Aileron), and **Chans** (all channels).

**Inst. Trim** (Instant Trim)- Sets all trims to the current values of their respective sticks.

**Reset** (Reset Timer)- Resets the timer or telemetry specified in the value back to their initial values.

- **Reset** - Options are **Tmr 1, Tmr 2, Tmr 3, All,** and **Telemetry**. See [Reset Telemetry](#) for more information on what data is reset for each option.

**Set** (Set Timer) - Sets the specified timer to the specified value.

- **Timer** - Options are **Tmr 1, Tmr 2, Tmr 3**
- **Value** - The range is 00:00:00 to 08:59:59

**Adjust** (Adjust Global Variable) - Changes the value of the specified global variable.

- **Global var** - Select the global variable that you want to adjust.
- **Mode** - Select the mode to change the global variable. Options are: **Constant, Mixer Source, Global var, Inc/Decrement**. Long-press the **[Enter]** button to select the mode.
  - **Constant** - Sets the specified global variable to the defined constant value.
  - **Mixer Source** - Sets the specified global variable to the defined mixer source value.
  - **Global Var** - Sets the specified global variable to the defined global variable value.
  - **Inc/Decrement** - Increments/decrements the specified global variable by the specified amount.

**Volume** - Changes the radio volume. The change source is specified in the Volume dropdown.

**SetFailsafe** - Sets the custom failsafe values for the selected module (Internal/External) to the current stick position when activated. For this option to work, the Failsafe mode for the RF module must be set to **custom**.

**Play Sound** - Plays the sound selected in the value field when activated.

- **Value** - Sound to play. Possible values are **Beep1/2/3, Warn1/2, Cheep, Ratata, Tick, Siren, Ring, SciFi, Robot, Chirp, Tada, Crickt, AlmClk**. *Note: SD card sound pack is not required.*
- **Repeat** - Frequency to repeat the sound. Options are **!1x** (do not play at startup even if the switch is active), **1x** (play once), **1s** thru **60s** (play every xx seconds).

**Play Track** - Plays the .wav sound file selected in the value field when activated.

- **Value** - .wav sound file to play from the SD card.
- **Repeat** - Frequency to repeat the track. Options are **!1x** (do not play at startup even if the switch is active), **1x** (play once), **1s** thru **60s** (play every xx seconds).  
**Play Val** - Announces the value of the selected element in the value field.
- **Value** - The source for the value to announce. It can be an input, stick, pot, slider, trim, physical and logical switch, trainer import channel value, global variable, telemetry sensor or channel.
- **Repeat** - Frequency to repeat the announcement. Options are **!1x** (do not announce at startup even if the switch is active), **1x** (announce once), **1s** thru **60s** (announce every xx seconds).  
**Lua Script** - Executes the Lua script defined in the value field. The Lua script must be located in /SCRIPTS/FUNCTIONS/ folder on the SD card. Lua scripts that display information on the screen cannot be executed with this special function.
- **Value** - LUA script file to play from the SD card.
- **Repeat** - Frequency to repeat the Lua script. Options are: **ON** (repeat indefinitely as long as switch is active) or **1x** (once)  
**BgMusic** - Plays the .wav file selected in the value field on a loop when enabled. The file shall be in the SOUNDS/(language)/ folder on the SD card.  
**BgMusic II** - Temporarily pauses the .wav file playback specified in the **BgMusic**  
**Vario** - Enables the variometer beeping sound for the ascent and descent of the model.  
**Haptic** - Causes the radio to vibrate (haptic feedback) when enabled.
- **Value** - Type of vibration pattern. Options are: 0 - 4.
- **Repeat** - Frequency to repeat the vibration pattern. Options are **!1x** (do not vibrate at startup even if the switch is active), **1x** (vibrate once), **1s** thru **60s** (vibrate every xx seconds).  
**SD Logs** - Creates a log .csv file of the radio and telemetry values in the LOGS folder on the SD Card. The radio will create a new entry into the log file based on the frequency configured in the **Value** setting. The value options are **0.0s** - **25.5s** (Note: 0.0 effectively disables this option). Each time the function is activated, the radio will create a new log file provided that the function is activated at least as long as the value setting.  
**Note:** Logging will not start if SD card has less than 50mb of free space.  
**Backlight** - Adjusts the brightness of the radio screen based on the source defined in the value dropdown.  
**Screenshot** - Creates screenshot as a .bmp file in the SCREENSHOT folder on the SD Card.  
**RacingMode** - Enables racing mode (low latency) for FrSky Archer RS receivers. Racing mode must also be enabled in External RF Module Settings.  
**Audio Amp Off** (select radios) - Disables the Audio Amplifier so that no sound comes from the speaker, including annoying feedback or interference. This option is only available on select radios.

## 7. Telemetry

Telemetry is data received from the model to the radio from various sensors. These sensors may be included in the radio receiver or flight controller or may be separate sensors, such as GPS, variometer, or magnetometer. The received telemetry data can be displayed by EdgeTX in widgets, configured in alarms or audio call-outs.

The Telemetry screen is where you configure these sensors to use in EdgeTX. Below are the following configuration options:

### 7.1. Sensors

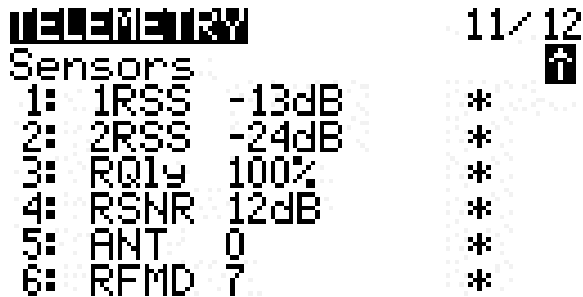

The screenshot shows a terminal-style display of the Telemetry screen. At the top, there are signal strength bars and the text '11/12' with a small arrow icon. Below that, the word 'Sensors' is displayed. A list of six sensors follows, each with a number, a name, a value, and an asterisk. The sensors are: 1: 1RSS -13dB, 2: 2RSS -24dB, 3: RQ1y 100%, 4: RSNR 12dB, 5: ANT 0, and 6: RFMD 7.

Index	Sensor Name	Value	Status
1:	1RSS	-13dB	*
2:	2RSS	-24dB	*
3:	RQ1y	100%	*
4:	RSNR	12dB	*
5:	ANT	0	*
6:	RFMD	7	*

Sensors portion of the Telemetry screen

All previously configured sensors are listed here. The list is collapsible by clicking on the **arrow icon** to the right side of the **Sensors** label. Sensors that have not received data since the model was loaded or the telemetry values were reset display --- for the values. The asterisk \* to the left of the sensor value will flash when the sensor has received a data update. A solid asterisk\* indicates that the sensors that are receiving regular updates. Sensors that are no longer receiving regular updates will not be marked with the asterisk\*. See [Common Telemetry Sensors](#) for a list of commonly used sensors in EdgeTX.

The following options are listed under the sensor list.

- **Discover New:** When selected, it will look for new sensors on the model and automatically configure them. If the sensor list is collapsed when a new sensor is discovered, the newly found sensor will be visible on the sensor list (old sensors will remain collapsed/hidden).
- **Add New:** When selected, it will create a new blank sensor for that must be configured manually.
- **Delete All:** This option will delete all previously configured sensors.
- **No inst. (ignore instances):** This option prevents multiple sensors from reporting the same telemetry data. If no sensors are listed in the sensors section, you may need to select **Discover New** to detect the sensors. Additionally, not all RF protocols transmit telemetry data.

If you long-press the **[Enter]** button for a specific sensor, the following options will be displayed:

- **Edit:** Allows you to edit the sensor's configuration options.
- **Copy:** Creates a copy of that sensor.
- **Delete:** Deletes that sensor.

See the [Sensor Configuration](#) page for a detailed description of all the configuration options for setting up or editing sensors.

```

RX Status
██████████ 11/12
Rqly
Low alarm      45
Critical alarm  42
Disable alarms 
Vario
Source  ---
Range  50 10

```

Rqly Portion of Telemetry screen

Here you can configure the threshold for the RX alarms. The Rx-Stats label will change (Rx-Stats, RSSI, Rqly, Sgnl) depending on the protocol that is used with the model.

- **Low alarm** - The threshold value when the "RF signal low" voice prompt will be played. The recommended value is 45.
- **Critical alarm** - The threshold value when the "RF signal critical" voice prompt will be played. The recommended value is 42.
- **Disable telemetry alarms** - When enabled, no alarm voice prompts will be played.

```

Variometer
██████████ 11/12
Add new
Delete all
No inst. ■
Rqly
Low alarm      45
Critical alarm  42
Disable alarms 

```

A variometer detects changes in the model altitude. EdgeTX can alert the user of these altitude changes by providing a rising/lower pitched tone. Use the **Variometer** menu on the Radio Setup page to set the actual frequency and volume of the tone to be played. The following options exist to configure the variometer alarm.

You will need to use a **Vario** Special or Global Function to enable this functionality!

- **Source** - Specifies the sensor to use as the variometer. It is selected from the telemetry sensors added in **Sensors** section.
- **Range** - Specifies the ascent/descent range that will trigger the change in the Variometer beeping pitch. If climb/descent rate is within the range specified here, beeping pitch will change according to that value. When it goes beyond the range specified here, beeping pitch will stop changing. Units are meters/second or feet/second based on the **Units** setting on the **Radio Setup** page.
- **Center** - Specify the range for ignoring changes in climb/descent rates. When the climb/descent rate is within the range specified here, the beeping pitch will not change.
- **Tone/Silent** - Specifies whether to beep when climb/descent rate is within the range specified by **Center**.

## 7.2. Sensor Configuration

```
SENSOR01      0
Name          ---
Type          Custom
ID            0000  0
Unit          -
Precision     0.--
Ratio         -
Offset        0
Sensor Configuration page
```

The below options can be configured for sensors:

- **Name:** Name of the sensor - up to 4 characters.
- **Type:** Options are **custom** or **calculated**. Custom sensors are defined by the hardware. Calculated sensors are a sensors whose value is calculated using other sensors values. See below for more information on calculated sensors.
- **ID:** This number indicates what type of sensor it is. It contains two parts. The first part is the ID number which defines the sensor type. The second part is the instance number for the hardware. If multiple sensors of the same type are configures, the instance numbers must be unique.
- **Unit:** The unit for the sensor. This unit is used when the sensor value is displayed on the screen or read aloud.
- **Precision:** Specifies the number of digits after the decimal point when the sensor value is displayed on the screen. The number is truncated based on this setting.
- **Ratio:** Specifies the ratio value to multiply with the sensor value as needed by some sensors.
- **Offset:** Specifies the offset value to add to the sensor value.
- **Auto Offset:** When selected, the first received value is used as offset. You can use the [Reset telemetry](#) option to reset the offset on already configured sensors.
- **Positive:** When selected, the value of the sensor will be displayed only when it is a positive number. Displays zero when the sensor value becomes a negative number.
- **Filter:** When selected, the sensor value becomes a rolling average of the last 5 received values.
- **Logs:** When selected, the value of this sensor will be saved in the log file. SD Card logging is configured in Special Functions or Global Functions.

Calculated sensors contain the additional configuration options:

- **Formula:** Type of calculation to use. Options include:
  - **Add:** Add the values of up to 4 designated sensors.
  - **Average:** Calculates the average value of up to four designated sensors.
  - **Minimum:** Find the minimum value of up to 4 designated sensors.
  - **Maximum:** Find the maximum value of up to 4 designated sensors.
  - **Multiply:** Multiplies the value of 2 sensors.
  - **Totalize:** Calculate the cumulative value of one sensor.
  - **Cell:** This is the formula for FrSKY Lipo battery sensor. It displays cell voltage specified by the number in "Cell index" field. If you specify "Lowest" in "Cell index" field, the voltage of the cell with the lowest is displayed. If you specify "Highest" in "Cell index" field, the voltage of the cell with the highest is displayed. If you specify "Delta" in "Cell index" field, the voltage difference between lowest and highest cell is displayed
  - **Consumption:** Calculates the power consumption (mAh) by cumulatively add the values of current sensor.
  - **Distance:** Calculates the distance between the receiver and the radio using GPS sensor and altimeter values.



- **Source 1, 2, 3, 4:** The sensors that will provide the argument values that are used in the formula defined above.
- **Persistent:** When selected the sensor values will be saved when switching between models or powering down the radio.

### 7.3. Common Telemetry Sensors

Name	Description	Data source
1RSS	Received signal strength antenna 1 (RSSI)	Receiver
2RSS	Received signal strength antenna 2 (RSSI)	Receiver
Rqly	Receiver link quality (valid packets)	Receiver
RSNR	Receiver signal-to-noise ratio	Receiver
RFMD	Receiver packet rate	Receiver
TPWR	Transmitter transmitting power	Transmitter
TRSS	Transmitter signal strength antenna	Transmitter
TQly	Transmitter link quality (valid packets)	Transmitter
TSNR	Transmitter signal-to-noise ratio	Transmitter
ANT	Sensor for debugging only	Transmitter
GPS	GPS Coordinates	GPS / Flight Controller
Alt	GPS Altitudes	GPS / Flight Controller
Sats	GPS Satellites acquired	GPS / Flight Controller
Hdg	Magnetic orientation	GPS / Flight Controller
RxBt	Battery voltage	Flight Controller
Curr	Current draw	Flight Controller
Capa	Current consumption	Flight Controller
Ptch	FC Pitch angle	Flight Controller
Roll	FC Roll angle	Flight Controller
Yaw	FC Yaw angle	Flight Controller
FM	Flight mode	Flight Controller
VSPD	Vertical Speed	Flight Controller w/ Baro

Each sensor has two auto generated sensors for their minimum and maximum values. They share the same name with a negative and positive symbol added to the end. For example: **RxBt +** This displays the maximum value that the sensor attained during the flight. Using the [Reset Telemetry](#) or Flight function will reset this value to 0.

## 8. Display

### 8.1. Display screen configuration

The **Display** screen is where you configure the telemetry screens shown when pressing the **[Tele]** button from the main screen.

You can configure up to Four telemetry screens. You can choose one of the following display types for each screen:

**Nums** (Numbers) - The **numbers** type displays the number value of the selected telemetry sensor or other configured object. The screen will be divided into two columns with four rows - each cell can display the data from a different sensor or object. On the display screen, the top bar will show the model name, radio battery voltage, and time in addition to the configured cells. If **Timer1** is configured in the model, then it will replace the model name in the top bar.

```
DISPLAY 12/12
Screen 1 Nums
  +RQ1y  +RxBt
  +RSNR  Batt
  +RFMD  ---
  +TPWR  Time
Screen 2 Bars
  Batt  6.0  8.4
Display Numbers Configuration
MODEL000 7.8V 10:11
+RQ1y 100 +RxBt 6.3
+RSNR 12 Batt 7.8
+RFMD 7
+TPWR 10 Time 10:11
```

Display Screen with Numbers

**Bars** - The **Bars** type displays a bar graph representing the value of the selected telemetry sensor or other configured object. The screen will be divided into four rows - each row can display the data from a different sensor or object. For each sensor, you must define the minimum and maximum values for the bars. On the display screen, the top bar will show the model name, radio battery voltage, and time in addition to the configured cells. If **Timer1** is configured in the model, then it will replace the model name in the top bar.

Additionally, a 5th bar will be shown at the bottom with the RSSI value.

```
DISPLAY 12/12
Screen 2 Bars
  Batt  6.0  8.4
  +RxBt- 6.0V 6.6V
  +RQ1y  0% 100%
  +RSNR  0dB 0dB
Screen 3 None
Screen 4 None
Display Bars Configuration
MODEL000 7.8V 10:11
Batt ██████████
+RxBt- ██████████
+RQ1y ██████████
+RSNR ██████████
RSSI : 99 ██████████
```

Display Screen with Bars

**Script**- The **Script** type executes the telemetry Lua script that is configured. The telemetry Lua script must be located in the SD card folder: SD Card->Scripts->Telemetry in order to be available to be configured.

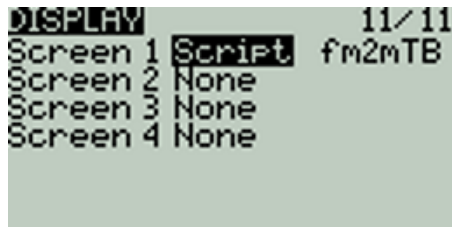

Display Script Configuration

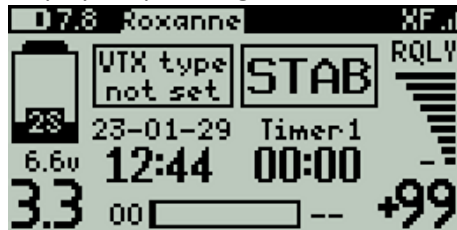

Display Screen with fm2m Lua Script

Additional Lua scripts for EdgeTX can be found here: <https://github.com/EdgeTX/lua-scripts>

To configure the screens, scroll to the screen you want to configure and then press the **[Enter]** button. Then scroll to select the type of screen that you want to use and press the **[Enter]** button to select it. Depending on the selected screen type, you can then configure the telemetry objects for each cell by scrolling to the desired object and selecting it by pressing the **[Enter]** button. After all desired cells are configured, press the **[Return]** button to exit out of the configuration menu.

## 9. Radio Settings

### 10.1. Tools

Pressing the **[SYS]** button from the Main view will open the **Tools** screen.

The **Tools** page in Radio Settings is where you can select Lua script-based tools for execution. Lua scripts that are located on the SD card in the **Tools** folder will be listed here. Selecting a tool will execute it. By default, EdgeTX includes several tools. Other tools can be downloaded and added to the SD card as well. The following tools are included in the default EdgeTX SD card.

### 10.2. Radio Setup

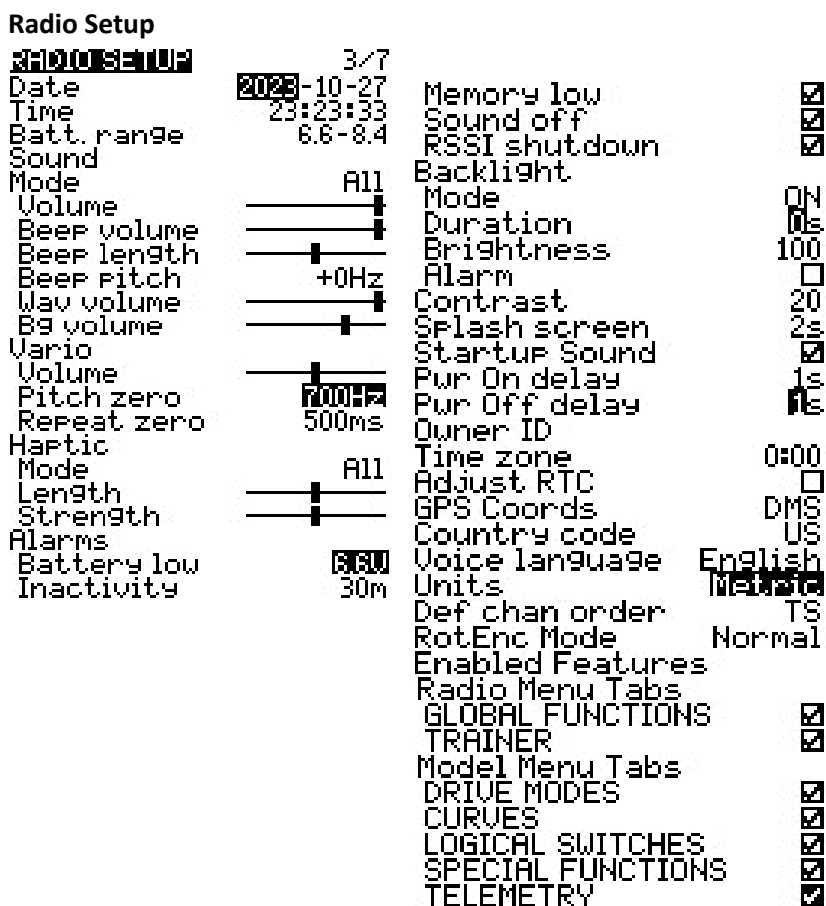

#### Radio Setup Screen

The **Radio Setup** screen is where you configure basic settings for your radio. It contains the following options:

**Date** - The current date. This date is used for the SD card log files.

**Time** - The current time. This time is used for the SD card log files.

**Batt. range** - Sets the maximum and minimum voltage for the battery meter. This should be set based on the type of battery you are using.

#### Sound

**Mode** - configures when to play sounds.

- **All** - Beeps when the buttons are pressed and sounds are played when there are alerts or warnings.
- **No Key** - No beeps when buttons are pressed or the scroll wheel is turned but does play sounds when there are alerts or warnings. Also plays sounds triggered by special functions.
- **Alarm** - Only plays alarm or warning sounds. Also plays sounds triggered by special functions.
- **Quiet** - No Beeps or sounds are played.

**Volume** - The master volume for the radio.

**Beep Volume** - Self-explanatory

**Beep Length** - Self-explanatory

**Beep Pitch** - Self-explanatory

**Wav volume** - The volume for alerts and warnings and sounds that are played with the **Play track** special function

**Bg volume** - The volume for background .wav files (music) that are played with the **BGMusic** special function

**Vario (Variometer)**

**Volume** - Volume for variometer beeps

**Pitch zero** - Low pitch frequency

**Pitch max** - High pitch frequency

**Repeat Zero** - The time before the tone repeats in milliseconds

Note: In order for the variometer to function, it must be turned on via the **Vario** special or global function.

See [Special Functions](#) for more information on how to configure this.

**Haptic**

**Mode** - configures when the radio vibrates.

- **All** - Vibrates when the buttons are pressed and when there are alerts or warnings.
- **No Key** - No vibrations when buttons are the pressed or scroll wheel is turned but does vibrate when there are alerts or warnings.
- **Alarm** - Only vibrates for alarms or warning sounds.
- **Quiet** - No vibrations are made

**Length** - Duration of vibration.

**Strength** - Strength of vibration

**Contrast** - Screen contrast setting.

**Alarms**

**Battery Low** - Voltage to trigger low battery alarm.

**Inactivity** - Time to trigger inactivity warning.

**Memory low** - Enable/disable low memory warning.

**Sound Off** - An "alarms disabled" visual warning is displayed when the transmitter is turned on if the sound mode is set to quiet.

**RSSI Shutdown** - Checks if a receiver is still connected to the radio on attempted shutdown. Makes a audio and visual alert if one is detected.

**Backlight**

**Mode**

- **Off** – Always off.
- **Keys** – Turns on when buttons are pressed.
- **Ctrl** – Turns on when sticks, switches, and knobs are used.
- **Both** – Turns on when buttons, sticks, switches, and knobs are used.
- **ON** – Always on.

**Duration** - The length in seconds that the backlight is on. The minimum value is 5 seconds. The maximum value is 600 seconds.

**Brightness** - Screen brightness level.

**Alarm** - The backlight turns on when there are alarms or warnings.

**Splash Screen** - Duration to display the splash screen.

**Power On delay** - The delay between when the power button is pushed and when the radio turns on. The options are: **0s, 1s, 2s, 3s**

**Pwr Off delay** - The delay between when the power button is pushed and when the radio shuts off. The options are: **0s, 1s, 2s, 3s, 4s**. *It is recommended to set at least a 1s delay in order to prevent the radio from being shut off in the case of an accidental button press.*

**Owner ID** - Custom registration ID used only for users with ISRM modules.

**Time Zone** - Time zone radio is operated in.

**Adjust RTC** - Adjust the transmitter's real-time clock to match the time determined by the GPS.

**GPS Coords** - The GPS coordinate format that will be displayed.

**Country code** - Used by some RF modules to ensure adherence to local regulatory RF requirements. Options are **America, Japan, Europe**.

**Voice language** - Language for the voice pack. This setting and the voice pack folder on the SD card must match for the sounds to be played.

**Units** - Units of measure. Options are **metric** or **imperial**.

**Play delay** (sw. mid pos) - The minimum time in milliseconds a switch must be in the middle position before a special function will get activated. This is used to prevent the middle position from being activated on a three-position switch when switching from low position to high position.

**USB Mode** - Sets the default action when a USB cable is plugged into the USB data port and the radio is powered on. Options are: **Ask, Joystick, Storage, and Serial**.

**Def Chan Ord** - The default channel order for new models and the trainer screen. The letters stand for: **A** = Aileron, **E** = Elevator, **T** = Throttle, **R** = Rudder. Changing this setting does not affect existing models.

**RotEnc Mode** (Rotary Encoder Mode) - Set to **Normal** by default. The **Inverted** option reverses the direction of the roller.

**Mode** - The stick mode that will be used for the transmitter. Defined by what actions the left stick takes. The options are:

- 1: Left = yaw+pit (pitch)
- 2: Left = yaw+thr (throttle)
- 3: Left = rol (roll)+pit (pitch)
- 4: Left = rol (roll)+thr (throttle)

### 10.3. Global Functions

**Global functions are special functions that apply to all models on the Radio. They are configured exactly as model Special Functions and the same functions are available. For more information about configuring Global Functions, refer to the [Special Functions](#) section as they are essentially the same.**

### 10.4. Trainer

The **Trainer** screen in Radio Settings is used to configure how the radio in Master mode will handle the signals from the radio in Slave mode. It contains the below configuration options.

```
TRAINER 5/7
Mode % Source
Ail := 100 CH2
Thr := 100 CH4
```

```
Multiplier 1.0
Cal 0 0 0 0
```

Trainer screen in Radio Settings

For each of the four main control inputs (Ail, Ele, Thr, Rud), the following options can be configured (for each row, from left to right).

**Mode** - How the radio in Master mode will handle the signals from the radio in Slave mode.

- **OFF** - Stick values from the radio in Master mode will be used - no input from the radio in Slave mode.
- **+=** Adds the stick values from both the radios in Master and Slave modes.
- **:=** Replaces the stick values from the radio in Master mode with the stick values from the radio in Slave mode. (Default)
- **Weight** - Percentage of stick travel to use of the radio in Slave mode. Use negative values to change the stick direction.

- **Source channel** - The channel from the radio in Slave mode that is mapped the control input.  
**Multiplier** - This value changes the weight of all the sticks together.  
**Cal (calibrate)**- Sets the center stick value of the radio in Slave mode.  
The trim from the radio in Master mode is usually used. Set the trims on the radio in Slave mode to their center.  
The radio in Master mode is the one that gets bound to the model receiver.

## 10.5. Hardware

The **Hardware** screen is where you configure hardware specific-settings for your radio. It shows all physical hardware objects (sticks, pots, switches) and allows for their modifications. It is also where you can calibrate your sticks and pots. It also contains additional configuration options.

```

Hardware 6/7
Axis      [Calibration]
JST ---
JTH ---
Pots
  S1 --- Pot      →
  S2 --- Pot      →
  S3 --- Switch   →
  S4 --- Switch   →
Switches
  SA --- 3POS
  SB --- Toggle
  SC --- Toggle
  SD --- Toggle
  FL1 S3 --- 6POS
  FL2 S4 --- 2POS

```

Hardware Screen

### Calibration

To calibrate your physical radio controls (sticks, pots, sliders, & 6-position switch), highlight the **[Calibration]** option and press the **[Enter]** button. The radio will prompt you through the calibration steps.

For your gimbal calibration, use a left-to-right & up-to-down movement for the gimbals, not a circular movement! Additionally, use the normal amount of pressure at the endpoints. Excessive endpoint pressure will cause the gimbal to be mis-calibrated. Also, do not forget to calibrate your 6-position switch!

### Inputs, Sticks, Pots, and Switches Buttons List

Selecting one of the Sticks, Pots, or Switches lines from the list will allow you to add a 3 character label to the control as well as change the type of control as needed.

### Additional hardware configuration options



```

Batt. calib 7.78V
RTC Batt    3.02V
Check RTC   
Audio mute  
Internal RF
Type        CRSF
Baudrate    5.25M
Sampling    Normal
Serial port
USB-UCP     CLI
ADC filter  
RAS         ---/---
Debug       [Anas][Keys]
Hardware Screen

```

**Batt. Calib** (Battery Calibration) - Set this value to match the transmitter battery voltage. This ensures that the displayed battery voltage is accurate.

**RTC Batt** - The current voltage of the RTC battery. The RTC (real time clock) battery keeps the radio's date and time accurate even when no main radio battery is present.

**Check RTC** - When enabled, checks the RTC battery at startup and warns you if the battery voltage is low.

**Audio Mute** - When enabled, puts the transmitter in mute mode until a sound needs to be played. This prevents interference noise from high-powered TX modules from coming out of the transmitter speakers.

**Internal RF Type** - Select the module type for the internal module bay. Options are: **Multi**, **XJT**, **ISRM**, **CRSF**. When **CRSF** is selected, you can also select the baud rate. You can read more about baud rates [here](#).

**Sample Mode (External RF)**- Options are **Normal** and **OneBit**. The default setting of **Normal** should be used by most users. Only users of X9D+ and X7 radios may want to use **OneBit** mode.

The X9D+ and X7 radios have a slow inverter that causes problems with the reception of fast UART signals, resulting in telemetry warnings and issues with LUA scripts using the CRSF protocol. A 10k resistor on the circuit board could be replaced to fix the issue, but this was not always effective. EdgeTX has developed OneBit Mode, which changes the UART sampling behaviour to ignore slow leading edges, allowing the CRSF protocol to be run at the full 400k baud rate without hardware modifications to the radio.

**Serial Port** - Displays a list of available auxiliary serial ports that can be configured and used. The listed ports are based on the ports that are available in the particular radio hardware. The ports listed below are for example only and may not be present in your radio.

- **AUX1** - First available auxiliary serial port can be configured with the below options:
  - **OFF** - Turned off.
  - **Telem Mirror** - The same telemetry data that goes to the external module bay is sent to the serial port.
  - **Telemetry In** - Receive telemetry data over the serial port.
  - **SBUS Trainer** - Connect the Instructor and Student radios over the serial port.
  - **LUA** - Send/receive data to/from Lua script.
  - **GPS** - Receive GPS telemetry data over the serial port.
  - **CLI** - Send commands to the radio via the command line.

**ADC Filter** - Enables or disables the ADC Filter. This filter can also be enabled/disabled per model in the model settings.

The ADC filter is a filter for the proportional channels (sticks, pots, sliders), smoothing out smaller fast movements that occur due to noise in the system electronics. Normally, this filter should be *disabled* for models with flight controllers.

**RAS** - (Formerly SWR) Reflected antenna signal. Lower numbers are better, with a 1:1 ratio being theoretically the best. Not supported by all RF Protocols.

**Debug**

The debug section allows for testing and debugging of the analog controls and keys.

```

[Calibrated Analogs]
Axis/Pots/Sliders
A1: 1026   0 A2: 1030   0
A3: 1006  -1 A4: 1036   1
A5: 0000 -100 A6: 1868  82
A7: 1149   0 A8: 0940   0

```

Debug Analogs screen

```

[Switches]
Exit  0 SA↑ FL2↓ Trim - +
Enter 0 SB↑      T1   0 0
PgUp  0 SC↑      T2   0 0
PgDn  0 SD↑      T3   0 0
MDL   0 FL1↑     T4   0 0
TELE  0          T5   0 0
SYS   0 R.E.    31

```

Debug Keys screen

**Debug Analogs** - These screens will show you the data for your analog controls (Sticks, Sliders, Pots, 6-position switch). There are two views - Calibrated Analogs, Raw Analogs (5 Hz).

**Debug Keys** - This screen will show you the digital data for your keys, switches, trims, and the rotary encoder (roller).

## 10.6. Version

### Version

The **Version** screen displays information about the current EdgeTX version that is being used:

```

[Version] 7/7
FW : edgetx-mt12
VERS: 2.10.0-selfbuild
GIT#: b64dfbbd
DATE: 2023-10-26 11:06:16

[Firmware options]
[Modules / RX version]

```

Version Screen

- **FW** - Firmware name
- **VERS** - Firmware version
- **NAME:** Firmware Codename
- **DATE** - Date & time the firmware was compiled

### Firmware Options

To view the build options that were enabled when compiled, highlight the **[Firmware options]** options and press the **[Enter]** button.

```
FIRMWARE OPTIONS
crossfire, ghost,
internalmulti,
internalaccess,
multimodule, luac, cli,
passthrough
```

Firmware Options Screen

A complete list of build options can be found here: <https://github.com/EdgeTX/edgetx/wiki/Compilation-options>

#### Modules / RX Version

To view the Modules / RX Version information about the activated RX modules for the currently selected model, highlight the **[Modules / RX Version]** option and press the **[Enter]** button.

```
MODULES / RX VERSION
Int. module
Module      250 Hz
Ext. module
Module      OFF
```

Modules / RX Version Screen

## 10. Contributors and Further information

### 11.1 Special thanks

Special thanks to all the people and groups that contributed (directly or indirectly) to online EdgeTX user manual this document is based on.

Many great tutorials and how-to guides can be found from these contributors on their youtube channels and web sites.

- Bill Clark - <https://www.youtube.com/@the-happy-RC-flyer>
- John - RCvidoereviews - <https://www.youtube.com/@RCVideoReviews>
- John Salt - <https://www.youtube.com/@Rchelicopterfun>
- Joshua Bardwell - <https://www.youtube.com/@JoshuaBardwell>
- Lee Schofield- Painless360 - <https://www.youtube.com/@Painless360>
- <http://rcdiy.ca/>
- <https://www.apollomaniacs.com>
- <https://doc.open-tx.org/opentx-taranis-manual/>
- <https://rc-soar.com/>

## 11.2 Links and resources

<https://edgetx.org/> EdgeTX website

<https://buddy.edgetx.org/> online flashing and SD card updating tool

### **Update from an earlier version of EdgeTX**

[Update from an earlier version of EdgeTX using EdgeTX Buddy](#)

[Update from an earlier version of EdgeTX using the Bootloader](#)

How to enter boodloader on MT12

<https://www.expresslrs.org/> ExpressLRS Website

<https://www.multi-module.org/> Multi-Module website

<https://www.radiomasterrc.com/pages/contact> Support information

<https://www.radiomasterrc.com/pages/downloads> Downloads and documents



### EU Simple Declaration of Conformity

RadioMaster declares the radio equipment MT12 is in compliance with EU directives Directive 2014/53/EU. Full text of the declaration of conformity is available at the following website

[www.radiomasterrc.com](http://www.radiomasterrc.com)

### Manufacturer by Radiomaster

4F Yang Tian Building, Area 72 Xing Dong community, Xin An Street, Bao An district, Shen Zhen city, Guangdong Province, China



**FCC ID: 2BBP3-MT12-ELRS**

**FCC ID: 2BBP3-MT12-4IN1**

### FCC Information

This equipment has been tested and found to comply with the limits for Part 15 of the FCC rules.

This device complies with part 15 of the FCC rules. Operation is subject to the following two conditions: (1) This device may not cause harmful interference, and (2) this device must accept any interference received, including interference that may cause undesired operation. Full text of the declaration of conformity is available at the following website [www.radiomasterrc.com](http://www.radiomasterrc.com)



### CAUTION:

Changes or modifications not expressly approved by the party responsible for compliance could void the user's authority to operate the equipment. This product contains a radio transmitter with wireless technology which has been tested and found to be compliant with the applicable regulations governing a radio transmitter in the 2.400GHz to 2.4835GHz frequency range.

### Antenna Separation Distance

When operating your RadioMaster transmitter, please be sure to maintain a separation distance of at least 20 cm between your body (excluding fingers, hands, wrists, ankles and feet) and the antenna to meet RF exposure safety requirements as determined by FCC regulations.

Portions of this manual are Copyright 2023 Radiomasterrc.com.

Portions of this manual have been used under the [Creative Commons Attribution-ShareAlike 4.0 International \(CC BY-SA 4.0\) license](https://creativecommons.org/licenses/by-sa/4.0/). Full credit is given to the EdgeTX team and contributors. More details can be found here: [EdgeTX Online manual](#)

