

INSTALLATION INSTRUCTIONS FOR STORAGE SYSTEM ITEM 8003

When installing the Dropout Storage System between new upper cabinet boxes, install the upper cabinet that the FIXED PLATE mounts on; i.e. if you are installing a "right facing" unit then first install the cabinet box to the left of the desired location for the Dropout Storage System. Be sure this cabinet is installed level, plumb, square and securely! This cabinet must have a solid flat and secure side panel for mounting the fixed plate to. We recommend that the surface for mounting the fixed plate should be at least 5/8" plywood. Do not install this unit to any surface that is less than 1/2" thick! Note: Check for screw penetration through surfaces that are less than 5/8" thick. If necessary, the screws may need the tips snipped off to avoid penetration. Placing the fixed plate is a very critical step! Be sure to mount the fixed plate correctly, using all 12 mounting screws.

The fixed plate must be mounted 1/2" behind the face of the cabinet (see drawing at right) and 3/16" above the cabinet bottom. If you choose to install a finished bottom on this unit, add the thickness of the finished bottom panel to the 3/16" space (for example, for a 1/2" finished bottom, install the fixed plate 11/16" above cabinet bottom).

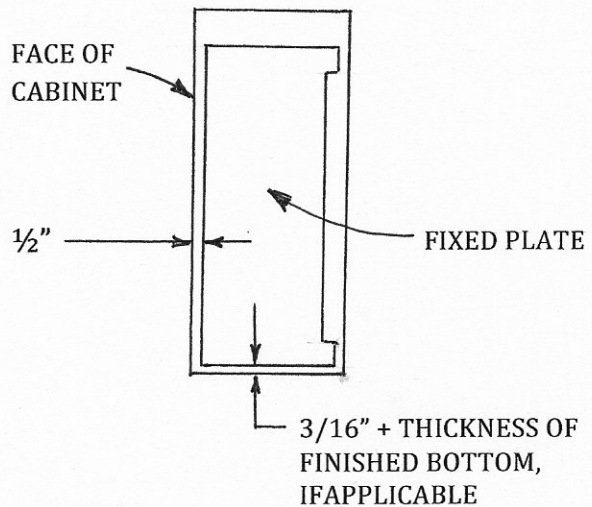

Mount fixed plate (Fig 1) on secured surface with 10 of the 12 #8x5/8" screws. Install the stop block in the bottom, forward corner (Fig 2) by placing the top hole over the small stud, then drive the installed screw (#2 square drive) through the hole in the fixed plate, keeping the block in the upright position.

Now, using a firm grip, pull the moving plate all the way down and out (Fig 3) and while holding firmly, fully install the thumbscrew into the upper threaded hole in the upper guide bar.

WARNING! The moving plate is under high spring tension! Use caution and hold securely until thumbscrew is fully installed under the upper arm.

Once the thumbscrew is fully installed let the upper plate return to the point of being stopped against the thumbscrew. This will hold the plate in the open position while completing the installation and for cleaning and servicing in the future.

At this point, insert the 3/16" hex driver (provided) into the lift adjuster hex screw (Fig 4) and rotate counter clockwise until the adjuster housing is moved to the far end of the upper arm. This reduces the lift power while the rack is empty and will need to be readjusted later when the rack is filled (See section on Adjusting for Weight of Contents)

Now complete the installation of the remaining screws to the fixed plate (Fig 5).

PREPARING THE RACK

First determine front and top of the rack. (attached wood block should be on the bottom).

Before installing the rack, mount the 3 plastic guide blocks on the rack using the 10-24x3/8" pan head machine screws. Place the largest guide block on the top of the rack (Fig 6) with the straight edge facing forward, one guide block back center and one guide block back bottom (Fig 7).

Place the rack on the four studs (Fig 8) protruding from the moving plate being sure the nylon washers are still in place as shipped (Fig 9) with the 4 nylock nuts.

THE DOOR MOUNT BLOCKS

Install the door mount blocks (Fig 10) to the forward side of the rack (Fig 11) with 3, 10-24x1/4" pan head screws each, being sure to mount them with the slotted side of the adjuster screws, facing to the inside of the rack.

Holding the rack down firmly with one hand, remove the thumbscrew with the other hand and fully install thumbscrew into the lower hole in the upper guide bar. Now gently move the Dropout Storage System up and into the cabinet.

Proceed with installing the next adjacent cabinet (Fig 12) **being sure to maintain 4 3/4" (NO MORE & NO LESS) of clear space, measured consistently front and back (parallel)**, for the Dropout Storage System to move freely.

INSTALLING THE DOOR

The door must be a solid panel with a minimum thickness of 11/16". To locate where to mount the door, attach a temporary cross block (Fig 13) to the bottom of the rack (adding the additional space required for the finished bottom, if applicable).

Now, with the Dropout in the closed position and the cross block resting against the bottoms of the adjacent cabinets (Fig 14), using a straight edge, adjust the door mount threaded inserts to be flush with the face of the cabinet being sure to allow for the thickness of the door bumper pads (Fig 15 & 16). Once set, gently tighten the setscrews (Fig 17) in the door mount blocks.

Measure the locations (Fig 18 & 19) of the screw holes and transfer to the desired locations on the back of the door. Start an appropriate pilot hole for each screw. Then open the Dropout and secure with the thumbscrew stop. Now attach the door (Fig 20) with 4 #6x1" pan head wood screws. **NOTE: Cabinet door handle should be already mounted prior to installing door panel!** Remove the thumbscrew and close to test the fit. If adjustment is needed, loosen the door mounting screw and the setscrew, then adjust the door mount adjuster insert with a coin, then retighten the set screws.

If you are installing a finished bottom (Fig 21) it should have a 1/8" gap from the adjacent finished bottoms all the way around. Fasten the finished bottom to the wood block on the bottom of the rack in the appropriate location.

Install the six trays to the button heads in the rack. Relocate the thumbscrew to the lower screw location on the upper guide bar (Fig 22) for future servicing. At this point the Dropout should be heavy enough to stay open (Fig 23) or closed (Fig 24) on its own., while allowing for free movement between open and closed positions.

ADJUSTING FOR WEIGHT OF CONTENTS

Once the Dropout is filled with the contents that will be stored within, it will need to be adjusted to compensate for the additional load. Using the 3/16" hex drive (provided), rotate the adjuster screw CLOCKWISE to increase the lift strength and COUNTER CLOCKWISE to decrease the lift strength.

The force needed to close the Dropout should be slightly greater than that needed to open it. This will help to compensate for when some contents are removed during use.

Should the user wish to remove more of the contents all at the same time (e.g. for cleaning or filling), the thumbscrew that is in the lower hole in the upper guide bar must be relocated to the upper hole and fully inserted to lock the Dropout open until the content weight is returned or the lift is readjusted for the change in weight of the contents.

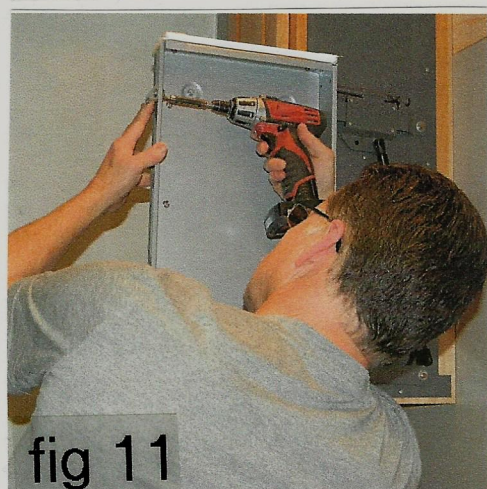
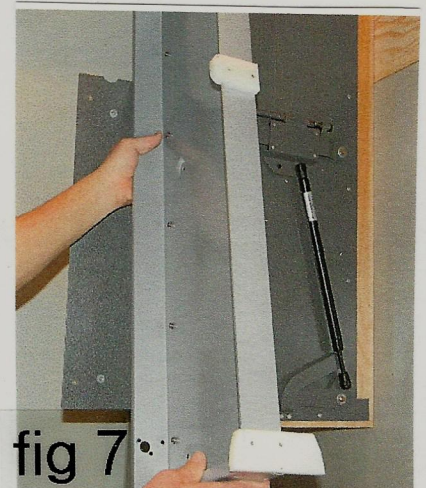
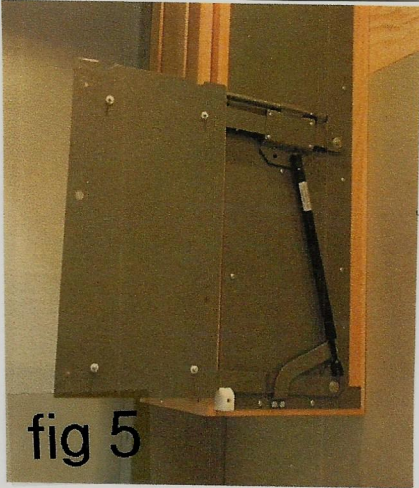
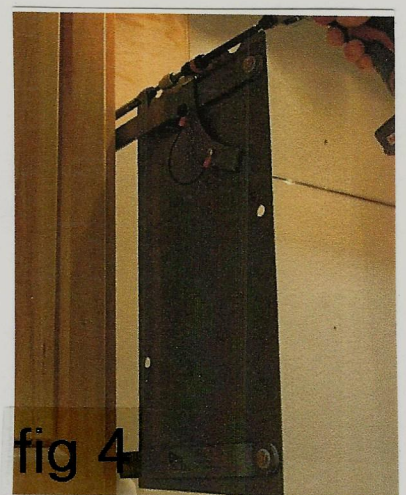
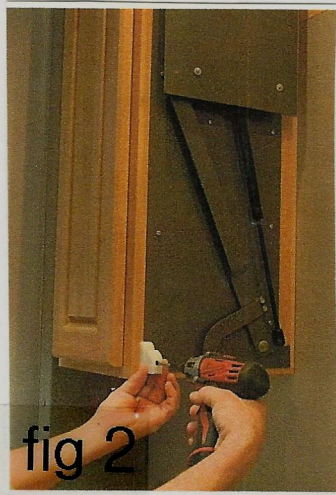
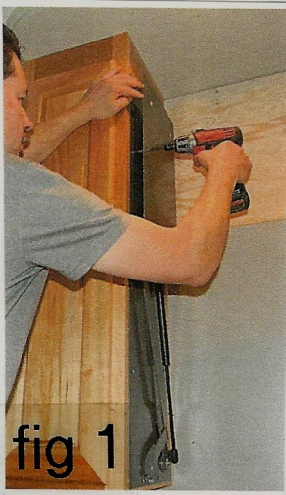



fig 14

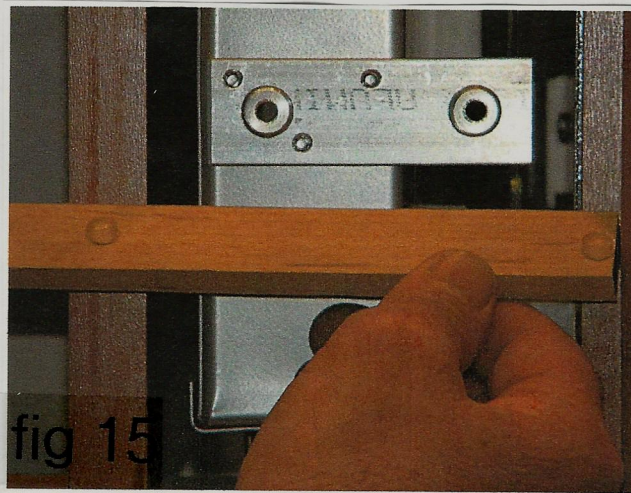

fig 15

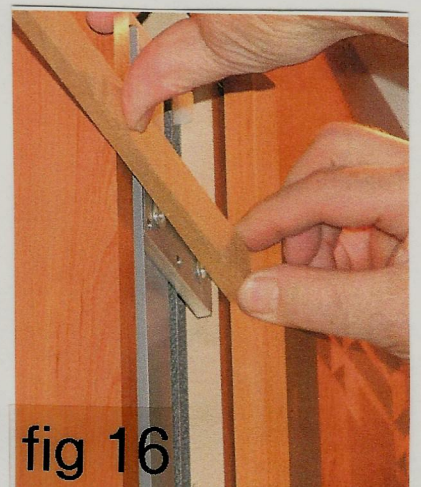

fig 16



fig 17

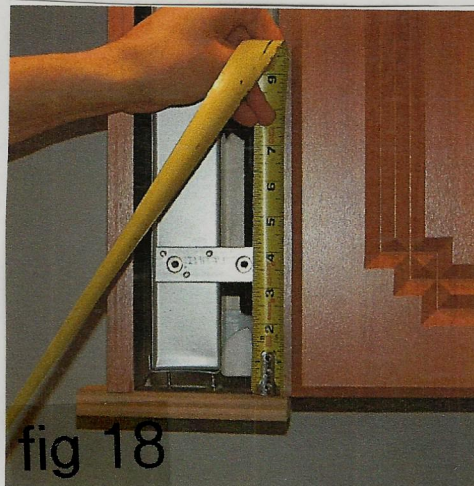

fig 18

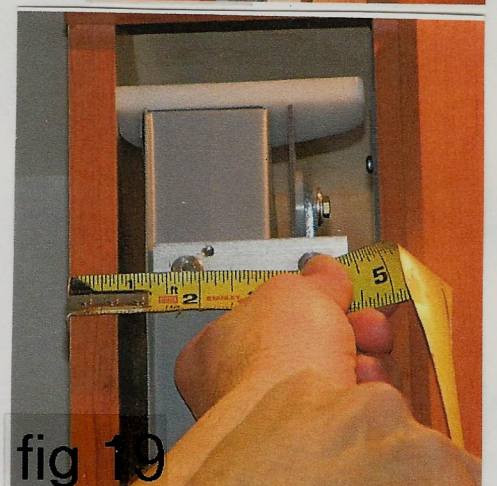

fig 19

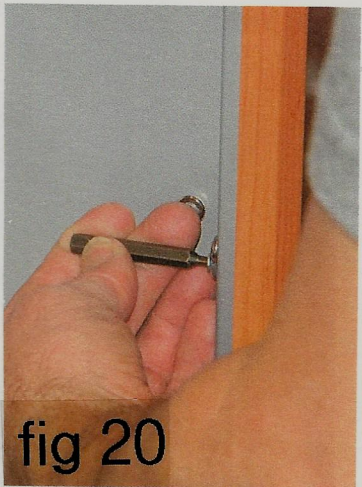

fig 20



fig 21

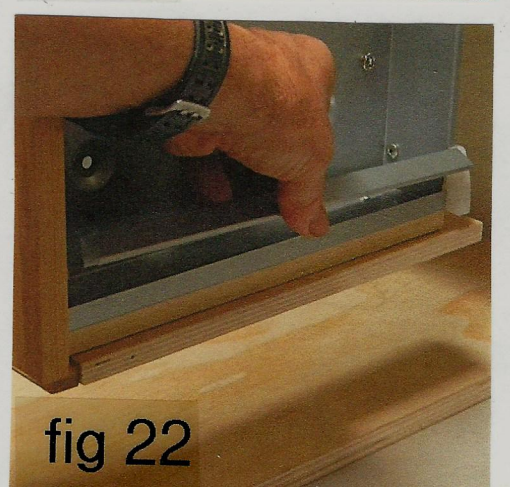

fig 22



fig 23



fig 24

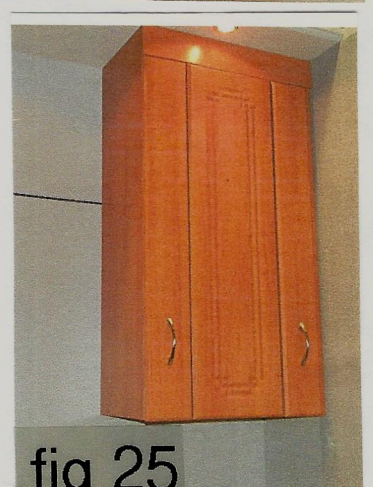

fig 25