

# Haier

## CASSETTE TYPE AIR CONDITIONER OPERATION MANUAL AND INSTALLATION MANUAL

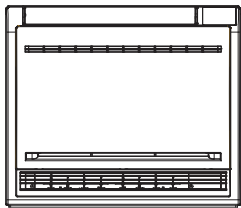

AF25S2SD1FA  
AF35S2SD1FA  
AF42S2SD1FA

English

Español

Italiano

Français

Deutsch

Português

No.0150535517

- This product must only be installed or serviced by qualified personnel.  
Please read this manual carefully before installation. This appliance is filled with R32.  
Keep this manual for future reference.  
Original instructions





## CASSETTE TYPE AIR CONDITIONER OPERATION MANUAL AND INSTALLATION MANUAL

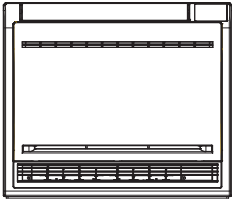

AF25S2SD1FA

AF35S2SD1FA

AF42S2SD1FA



### Contents

Cautions .....	5
Safety Precautions .....	10
Remote Controller Operation Manual .....	11
Special functions and instructions .....	13
Troubleshooting .....	14
Customer Need-to-know .....	16
Maintenance .....	17
Installation Procedure .....	18

English

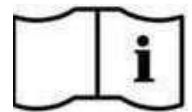
- This product must only be installed or serviced by qualified personnel.  
Please read this manual carefully before installation. This appliance is filled with R32.  
Keep this manual for future reference.  
Original instructions

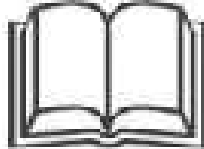

	<p>Read the precautions in this manual carefully before operating the unit.</p>		<p>This appliance is filled with R32.</p>
	<p>Service indicator; Read technical manual</p>		<p>Read the operator's manual</p>

Keep this manual where the user can easily find it.

## WARNING

- Do not use means to accelerate the defrosting process or to clean, other than those recommended by the manufacturer.
- The appliance must be stored in a room without continuously operating ignition sources (for example: open flames, an operating gas appliance or an operating electric heater).
- Do not pierce or burn.
- Be aware that refrigerants may not contain an odour.
- If the supply cord is damaged, it must be replaced by the manufacturer, its service agent or similarly qualified persons in order to avoid a hazard.
- This appliance can be used by children aged 8 years and above and persons with reduced physical, sensory or mental capabilities or lack of experience and knowledge if they have been given supervision or instruction concerning use of the appliance in a safe way and understand the hazards involved. Children shall not play with the appliance. Cleaning and user maintenance shall not be made by children without supervision.
- The wiring method should be in line with the local wiring standard.
- All the cables shall have got the European authentication certificate. During installation, when the connecting cables break off, it must be assured that the grounding wire is the last one to be broken off. The explosion-proof breaker of the air conditioner should be all-pole switch. Distance between its two contacts should not be no less than 3mm. Such means for disconnection must be incorporated in the wiring.
- Make sure installation is done according to local wiring regulation by professional persons.
- Make sure ground connection is correct and reliable.  
A leakage explosion-proof breaker must be installed.
- Do not use a refrigerant other than the one indicated on the outdoor unit(R32) when installing, moving or repairing. Using other refrigerants may cause trouble or damage to the unit, and personal injury.
- The installation and service of this product shall be carried out by professional personnel, who have been trained and certified by national training organizations that are accredited to teach the relevant national competency standards that may be set in legislation.
- Mechanical connectors used indoors shall comply with ISO 14903. When mechanical connectors are reused indoors, sealing parts shall be renewed. When flared joints are reused indoors, the flare part shall be re-fabricated.
- This appliance is intended to be used by expert or trained users in shops, in light industry and on farms, or for commercial use by lay persons ; ⚠
- Disconnect the appliance from its power source during service and when replacing parts

---

## WARNING

---

- A brazed, welded, or mechanical connection shall be made before opening the valves to permit refrigerant to flow between the refrigerating system parts. A vacuum valve shall be provided to evacuate the interconnecting pipe and/or any uncharged refrigerating system part.
- The maximum working pressure is 4.3 MPa.
- This maximum working pressure shall be considered when connecting the outdoor unit to indoor unit.
- The refrigerant suitable for the indoor unit is R32 or R410A. The indoor unit shall only be connected to outdoor unit suitable for the same refrigerant.
- The unit is a partial unit air conditioner, complying with partial unit requirements of the International Standard, and must only be connected to other units that have been confirmed as complying to corresponding partial unit requirements of the International Standard.
- The A-weighted sound pressure level is below 70 dB.
- The maximum refrigerant charge amount (kg), and the minimum floor area (m<sup>2</sup>) of the room in which the indoor unit will be installed, are specified in the table on the page 10.
- Pipe-work shall be protected from physical damage and, in the case of flammable refrigerants, shall not be installed in an unventilated space, if the space is smaller than that specified in the table on the page 10
- The installation of pipe-work shall be kept to a minimum.
- Compliance with national gas regulations shall be observed.
- Mechanical connections shall be accessible for maintenance purposes.
- Handling, installation, cleaning, servicing and disposal of refrigerant shall be carried out as per the specifications on the following pages strictly.
- Warning: Keep any required ventilation openings clear of obstruction.
- Notice: Servicing shall be performed only as recommended by this manual instruction.

# Haier

Haier Industrial Park, Qianwangang Road, Eco-Tech Development Zone, Qingdao 266555, Shandong, PRC

## EUROPEAN REGULATIONS CONFORMITY FOR THE MODELS

### CE

All the products are in conformity with the following European provision:

- Low voltage Directive
- Electromagnetic Compatibility

### ROHS

The products are fulfilled with the requirements in the directive 2011/65/EU of the European parliament and of council on the Restriction of the use of Certain Hazardous Substances in Electrical and Electronic Equipment(EU RoHS Directive)

### WEEE

In accordance with the directive 2012/19/EU of the European parliament,herewith we inform the consumer about the disposal requirements of the electrical and electronic products.

### DISPOSAL REQUIREMENTS:



Your air conditioning product is marked with this symbol.This means that electrical and electronic products shall not be mixed with unsorted household waste.Do not try to dismantle the system yourself:the dismantling of the air

conditioning system,treatment of the refrigerant,of oil and of other part must be done by a qualified installer in accordance with relevant local and national legislation.Air conditioners must be treated at a specialized treatment facility for reuse, recycling and recovery.By ensuring this product is disposed of correctly,you will help to prevent potential negative consequences for the environment and humen health.Please contact the installer or local authority for more information. Battery must be removed from the remote controller and disposed of separately in accordance with relevant local and national legislation.

## IMPORTANT INFORMATION REGARDING THE REFRIGERANT USED

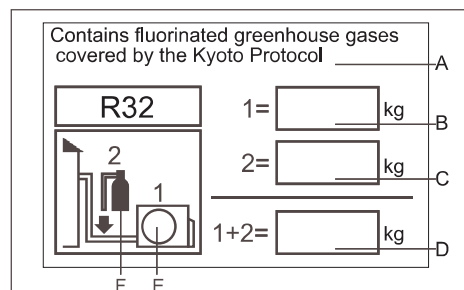

This product contains fluorinated greenhouse gases covered by the Kyoto Protocol.Do not vent into the atmosphere.

Refrigerant type:R32

GWP:675

GWP=global warming potential

Please fill in with indelible ink,

- 1 the factory refrigerant charge of the product
- 2 the additional refrigerant amount charged in the field and

• 1+2 the total refrigerant charge

on the refrigerant charge label supplied with the product.

The filled out label must be adhered in the proximity of the product charging port(e.g.onto the inside of the stop value cover).

A contains fluorinated greenhouse gases covered by the Kyoto Protocol

B factory refrigerant charge of the product:see unit name plate

C additional refrigerant amount charged in the field

D total refrigerant charge

E outdoor unit

F refrigerant cylinder and manifold for charging

## ⚠ WARNING

If the supply cord is damaged, it must be replaced by the manufacturer, its service agent or similarly qualified persons in order to avoid a hazard.

This appliance is not intended for use by persons (including children) with reduced physical, sensory or mental capabilities, or lack of experience and knowledge, unless they have been given supervision or instruction concerning use of the appliance by a person responsible for their safety.

Children should be supervised to ensure that they do not play with the appliance.

This appliance can be used by children aged from 8 years and above and persons with reduced physical, sensory or mental capabilities or lack of experience and knowledge if they have been given supervision or instruction concerning use of the appliance in a safe way and understand the hazards involved. Children shall not play with the appliance. Cleaning and user maintenance shall not be made by children without supervision.

The appliances are not intended to be operated by means of an external timer or separate remote-control system.

Keep the appliance and its cord out of reach of children less than 8 years.

# Cautions

## Disposal of the old air conditioner

Before disposing an old air conditioner that goes out of use, please make sure it's inoperative and safe. Unplug the air conditioner in order to avoid the risk of child entrapment.

It must be noticed that air conditioner system contains refrigerants, which require specialized waste disposal. The valuable materials contained in an air conditioner can be recycled. Contact your local waste disposal center for proper disposal of an old air conditioner and contact your local authority or your dealer if you have any question. Please ensure that the pipework of your air conditioner does not get damaged prior to being picked up by the relevant waste disposal center, and contribute to environmental awareness by insisting on an appropriate, anti-pollution method of disposal.

## Disposal of the packaging of your new air conditioner

All the packaging materials employed in the package of your new air conditioner may be disposed without any danger to the environment.

The cardboard box may be broken or cut into smaller pieces and given to a waste paper disposal service. The wrapping bag made of polyethylene and the polyethylene foam pads contain no fluorochloric hydrocarbon.

All these valuable materials may be taken to a waste collecting center and used again after adequate recycling.

Consult your local authorities for the name and address of the waste materials collecting centers and waste paper disposal services nearest to your house.

## Safety Instructions and Warnings

Before starting the air conditioner, read the information given in the User's Guide carefully. The User's Guide contains very important observations relating to the assembly, operation and maintenance of the air conditioner.

The manufacturer does not accept responsibility for any damages that may arise due to non-observation of the following instruction.

- Damaged air conditioners are not to be put into operation. In case of doubt, consult your supplier.
- Use of the air conditioner is to be carried out in strict compliance with the relative instructions set forth in the User's Guide.
- Installation shall be done by professional people. Don't install unit by yourself.
- For the purpose of safety, the air conditioner must be properly grounded in accordance with specifications.
- Always remember to unplug the air conditioner before opening inlet grill. Always grip plug firmly and pull straight out from the outlet.
- All electrical repairs must be carried out by qualified electricians. Inadequate repairs may result in a major source of danger for the user of the air conditioner.
- Do not damage any parts of the air conditioner that carry refrigerant by piercing or perforating the air conditioner's

tubes with sharp or pointed items, crushing or twisting any tubes, or scraping the coatings off the surfaces. If the refrigerant spurts out and gets into eyes, it may result in serious eye injuries.

- Do not obstruct or cover the ventilation grille of the air conditioner. Do not put fingers or any other things into the inlet/outlet and swing louver.
- Do not allow children to play with the air conditioner. In no case should children be allowed to sit on the outdoor unit. When the indoor unit is turned on, the PCB will test if swing motor is O.K., and then fan motor will start up. So there is a few seconds to wait.
- In cooling mode, the flaps will swing automatically to a fixed position for anti-condensating.
- This appliance is not intended for use by persons (including children) with reduced physical, sensory or mental capabilities, or lack of experience and knowledge, unless they have been given supervision or instruction concerning use of the appliance by a person responsible for their safety.
- Children should be supervised to ensure that they do not play with the appliance.

## Specifications

The refrigerating circuit is leak-proof.

For all the models in this manual, the all-pole disconnection connection method should be applied in the power supply. Such means for disconnection must be incorporation in the fixed wiring.

Cooling	Indoor temperature	max. DB/WB min. DB/WB	32/23°C 18/14°C
	Outdoor temperature	max. DB/WB min. DB/WB	46/26°C 10/6°C
Heating	Indoor temperature	max. DB/WB min. DB/WB	27°C 15°C
	Outdoor temperature	max. DB/WB min. DB/WB	24/18°C -15°C

If the supply cord is damaged, it must be replaced by the manufacturer or its service agent or a similar qualified person. If the fuse on PC board is broken please change it with the type of T 3.15A /250VAC.

The wiring method should be in line with the local wiring standard.

The waste battery shall be disposed properly.

The air breaker and the power switch should installed the conveniently reachable place for user.

The specification of power cable is H05RN-F3G 4.0mm<sup>2</sup>. Cable between indoor unit to outdoor unit is H05RN-F4G 2.5mm<sup>2</sup>.

# Cautions

---

The installation of pipe-work shall be kept to a minimum. Pipe-work shall be protected from physical damage and shall not be installed in an unventilated space, if that space is smaller than  $A_{min}(2m^2)$ .

- Compliance with national gas regulations shall be observed.
- Mechanical connections shall be accessible for maintenance purposes.

The minimum floor area of the room:  $2m^2$ .

- The maximum refrigerant charge amount: 1.7 kg.
- Information for handling, installation, cleaning, servicing and disposal of refrigerant.
- Warning: Keep any required ventilation openings clear of obstruction.
- Notice: Servicing shall be performed only as recommended by the manufacturer.

## Unventilated areas

- Warning: The appliance shall be stored in a well-ventilated area where the room size corresponds to the room area as specified.
- Warning: The appliance shall be stored in a room without continuously operating open flames (e.g. an operating gas appliance) and ignition sources (e.g. an operating electric heater).

## Qualification of workers

- Specific information about the required qualification of the working personnel for maintenance, service and repair operations.
- Warning: Every working procedure that affects safety means shall only be carried out by competent persons. Examples for such working procedures are:
  - breaking into the refrigerating circuit.
  - opening of sealed components
  - opening of ventilated enclosures.

## Information on servicing

- Prior to beginning work on systems, safety checks are necessary to ensure that the risk of ignition is minimized.
- work shall be undertaken under a controlled procedure so as to minimize the risk of flammable gas or vapor being present while the work is being performed.
- work in confined spaces shall be avoided. The area around the workspace shall be sectioned off. Ensure that the conditions within the area have been made safe by control of flammable material.

## Checking for presence of refrigerant

- The area shall be checked with an appropriate refrigerant detector prior to and during work. The leak detection equipment should be suitable for use with all applicable refrigerants, i.e. non-sparking, adequately sealed or intrinsically safe.

## Presence of fire extinguisher

- If any hot work is to be conducted, appropriate fire extinguishing equipment shall be available to hand. Have a dry powder or CO<sub>2</sub> fire extinguisher adjacent to the charging area.

## No ignition sources

- All possible ignition sources, including cigarette smoking, should be kept sufficiently far away from the site of installation, repairing, removing and disposal. Prior to work taking place, the area around the equipment is to be surveyed to make sure that there are no flammable hazards or ignition risks. "No Smoking" signs shall be displayed.

## Ventilated area

- Ensure that the area is in the open or that it is adequately ventilated before breaking into the system or conducting any hot work. A degree of ventilation shall continue during the period that the work is carried out. The ventilation should safely disperse any released refrigerant and preferably expel it externally into the atmosphere.

## Checks to the refrigeration equipment

- Where electrical components are being changed, they shall be fit for the purpose and to the correct specification. At all times the manufacturer's maintenance and service guidelines shall be followed. If in doubt, consult the manufacturer's technical department for assistance. The following checks shall be applied to installations
  - The charge size is in accordance with the room size within which the refrigerant containing parts are installed;
  - The ventilation machinery and outlets are operating adequately and are not obstructed;
  - If an indirect refrigerating circuit is being used, the secondary circuit shall be checked for the presence of refrigerant;
  - Marking to the equipment continues to be visible and legible. Markings and signs that are illegible shall be corrected;
  - Refrigeration pipe or components are installed in a position where they are unlikely to be exposed to any substance which may corrode refrigerant containing components, unless the components are constructed of materials which are inherently resistant to being corroded or are suitably protected against being so corroded.

## Checks to electrical devices

- Repair and maintenance to electrical components shall include initial safety checks and component inspection procedures. If a fault exists that could compromise safety, then no electrical supply shall be connected to the circuit until it is satisfactorily dealt with. If the fault cannot be corrected immediately but it is necessary to continue operation, an adequate temporary solution shall be used. This shall be reported to the owner of the equipment so all parties are advised.
- Initial safety checks shall include:
  - that capacitors are discharged: this shall be done in a safe manner to avoid possibility of sparking;
  - that no live electrical components and wiring are exposed while charging, recovering or purging the system;
  - that there is continuity of earth bonding.



# Cautions

## Repairs to sealed components

- During repairs to sealed components, all electrical supplies shall be disconnected prior to any removal of sealed covers, etc. If it is absolutely necessary to have an electrical supply to equipment during servicing, then a permanently operating form of leak detection shall be located at the most critical point to warn of a potentially hazardous situation.
- Ensure that by working on electrical components, the casing is not altered in such a way that the level of protection is affected, including damage to cables, excessive number of connections, terminals not made to original specification, damage to seals, incorrect fitting of glands, etc.
- Ensure that the apparatus is mounted securely.
- Ensure that seals or sealing materials have not degraded to the point that they no longer serve the purpose of preventing the ingress of flammable atmospheres. Replacement parts shall be in accordance with the manufacturer's specifications.

## Repair to intrinsically safe components

- Do not apply any permanent inductive or capacitance loads to the circuit without ensuring that this will not exceed the permissible voltage and current permitted for the equipment in use.
- Intrinsically safe components are the only types that can be worked on while live in the presence of a flammable atmosphere.
- Replace components only with parts specified by the manufacturer. Other parts may result in the ignition of refrigerant in the atmosphere from a leak.

## Cabling

- Check that cabling will not be subject to wear, corrosion, excessive pressure, vibration, sharp edges or any other adverse environmental effects. The check shall also take into account the effects of aging or continual vibration from sources such as compressors or fans.

## Detection of flammable refrigerants

### Removal and evacuation

- The refrigerant charge shall be recovered into the correct recovery cylinders and the system shall be "flushed" with OFN to render the unit safe. This process may need to be repeated several times.
- Compressed air or oxygen shall not be used for purging refrigerant systems.
- Flushing shall be achieved by breaking the vacuum in the system with OFN and continuing to fill until the working pressure is achieved, then venting to atmosphere, and finally pulling down to a vacuum. This process shall be repeated until no refrigerant is within the system. When the final OFN charge is used, the system shall be vented down to atmospheric pressure to enable work to take place.
- The vacuum pump is not close to any ignition sources and that ventilation is available.

## Charging procedures

- Ensure that contamination of different refrigerants does not occur when using charging equipment. Hoses or lines shall be as short as possible to minimise the amount of refrigerant contained in them.
- Cylinders shall be kept upright.
- Ensure that the refrigeration system is earthed prior to charging the system with refrigerant.
- Label the system when charging is complete (if not already).
- Extreme care shall be taken not to overfill the refrigeration system.  
Prior to recharging the system, it shall be pressure-tested
- with the appropriate purging gas. The system shall be leak-tested on completion of charging but prior to commissioning. A follow up leak test shall be carried out prior to leaving the site.

## Decommissioning

- Before carrying out this procedure, it is essential that the technician is completely familiar with the equipment and all its detail.
- Prior to the task being carried out, an oil and refrigerant sample shall be taken in case analysis is required prior to re-use of reclaimed refrigerant.
- Electrical power must be available before the task is commenced.
- Become familiar with the equipment and its operation.
- Isolate system electrically.
- Before attempting the procedure, ensure that:
  - mechanical handling equipment is available, if required, for handling refrigerant cylinders;
  - all personal protective equipment is available and being used correctly;
  - the recovery process is supervised at all times by a competent person;
  - recovery equipment and cylinders conform to the appropriate standards.
- Pump down refrigerant system, if possible.
- If a vacuum is not possible, make a manifold so that refrigerant can be removed from various parts of the system.
- Make sure that cylinder is situated on the scales before recovery takes place.
- Start the recovery machine and operate in accordance with manufacturer's instructions.
- Do not overfill cylinders. (No more than 80 % volume liquid charge).
- Do not exceed the maximum working pressure of the cylinder, even temporarily.
- When the cylinders have been filled correctly and the process completed, make sure that the cylinders and the equipment are removed from site promptly and all isolation valves on the equipment are closed off.
- Recovered refrigerant shall not be charged into another refrigeration system unless it has been cleaned and checked.

# Cautions

---

## Labelling

- Equipment shall be labelled stating that it has been de-commissioned and emptied of refrigerant. The label shall be dated and signed.
- Ensure that there are labels on the equipment stating the equipment contains flammable refrigerant.

## Recovery

- When transferring refrigerant into cylinders, ensure that only appropriate refrigerant recovery cylinders are employed.
- Ensure that the correct number of cylinders for holding the total system charge are available. All cylinders to be used are designated for the recovered refrigerant and labelled for that refrigerant (i.e. special cylinders for the recovery of refrigerant).
- Cylinders shall be complete with pressure-relief valve and associated shut-off valves in good working order. Empty recovery cylinders are evacuated and, if possible, cooled before recovery occurs.
- The recovery equipment shall be in good working order with a set of instructions concerning the equipment that is at hand and shall be suitable for the recovery of all appropriate refrigerants.

- A set of calibrated weighing scales shall be available and in good working order. Hoses shall be complete with leak-free disconnect couplings and in good condition. Before using the recovery machine, check that it is in satisfactory working order, has been properly maintained and that any associated electrical components are sealed to prevent ignition in the event of a refrigerant release. The recovered refrigerant shall be returned to the refrigerant supplier in the correct recovery cylinder, and the relevant waste transfer note arranged. Do not mix refrigerants in recovery units and especially not in cylinders.
- If compressors or compressor oils are to be removed, ensure that they have been evacuated to an acceptable level to make certain that flammable refrigerant does not remain within the lubricant.
- The evacuation process shall be carried out prior to returning the compressor to the suppliers. Only electric heating to the compressor body shall be employed to accelerate this process.

# Cautions

---

Carefully read the following information in order to operate the air conditioner correctly. Below are listed three kinds of Safety Cautions and Suggestions.

**⚠ WARNING:** Incorrect operations may result in severe consequences of death or serious injuries.

**⚠ CAUTION:** Incorrect operations may result in injuries or machine damages; in some cases may cause serious consequences.

**⚠ INSTRUCTIONS:** These information can ensure the correct operation of the machine.

Symbols used in the illustrations

⊘: Indicates an action that must be avoided.

ⓘ: Indicates that important instructions must be followed.

⚡: Indicates a part which must be grounded.

⚡: Beware of electric shock (This symbol is displayed on the main unit label.)

Be sure to conform with the following important Safety Cautions.

- After reading this handbook, hand it over to those who will be using the unit.
- The user of the unit should keep this manual at hand and make it available to those who will be performing repairs or relocating the unit. Also, make it available to the new user when the user changes hands.

# Cautions

## ⚠ WARNING

Please call Sales/Service Shop for the Installation.

Do not attempt to install the air conditioner by yourself because improper works may cause electric shock, fire, water leakage.

## ⚠ WARNING

When abnormality such as burnt-smell found, immediately stop the operation button and contact sales shop.

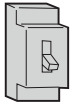

OFF



**!**  
STRICT  
ENFORCEMENT

Use an exclusive power source with a circuit breaker

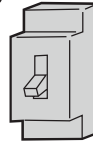

Check proper installation of the drainage securely

**!**  
STRICT  
ENFORCEMENT

Connect power supply cord to the outlet completely



**!**  
STRICT  
ENFORCEMENT

Use the proper voltage



**!**  
STRICT  
ENFORCEMENT

1. Do not use power supply cord extended or connected in halfway  
2. Do not install in the place where there is any possibility of inflammable gas leakage around the unit.  
3. Do not get the unit exposed to vapor or oil steam.

**⊘**  
PROHIBITION

Do not use power supply cord in a bundle.

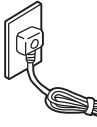

**⊘**  
PROHIBITION

Take care not to damage the power supply cord.

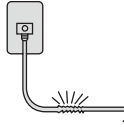

**⊘**  
PROHIBITION

Do not insert objects into the air inlet or outlet.



**⊘**  
PROHIBITION

Do not start or stop the operation by disconnecting the power supply cord and so on.



**⊘**  
PROHIBITION

Do not channel the air flow directly at people, especially at infants or the aged.



**⊘**  
PROHIBITION

Do not try to repair or reconstruct by yourself.



Connect the earth cable.

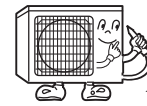

**⏚**  
earthing

## ⚠ CAUTION

Do not use for the purpose of storage of food, art work, precise equipment, breeding, or cultivation.



**⊘**  
PROHIBITION

Take fresh air occasionally especially when gas appliance is running at the same time.

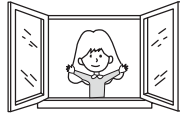

**!**  
STRICT  
ENFORCEMENT

Do not operate the switch with wet hand.

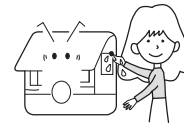

**⊘**  
PROHIBITION

Do not install the unit near a fireplace or other heating apparatus.



**⊘**  
PROHIBITION

Check good condition of the installation stand

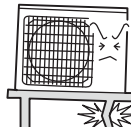

**⊘**  
PROHIBITION

Do not pour water onto the unit for cleaning

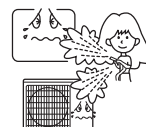

**⊘**  
PROHIBITION

Do not place animals or plants in the direct path of the air flow



**⊘**  
PROHIBITION

Do not place any objects on or climb on the unit.



**⊘**  
PROHIBITION

Do not place flower vase or water containers on the top of the unit.



**⊘**  
PROHIBITION

# Cautions

## ⚠ INSTRUCTIONS:

Please ask the dealer or specialist to install, never try by the users themselves. After the installation please be sure of the following conditions.

## ⚠ WARNING:

Please call dealer to install the air-conditioner.

Incorrect installation may cause water leaking, shock and fire hazard.

## ⚠ CAUTION:

- Air-conditioner can't be installed in the environment with inflammable gases because the inflammable gases near to air conditioner may cause fire hazard.
- Installed electrical-leaking circuit breaker. It easily cause electrical shock without circuit breaker.
- Connect earthing wire. Earthing wire should not be connected to the gas pipe, water pipe, lightning rod or phone line, incorrect earthing may cause shock.



Earthing

Use discharge pipe correctly to ensure efficient discharge. Incorrect pipe use may cause water leaking.

## [Location]

- Air-conditioner should be located in well-vented and easily-accessible place.
- Air-conditioner should not be located in the following places:
  - (a) Places with machine oils or other oil vapours.
  - (b) Seaside with high salt content in the air.
  - (c) Near to hot spring with high content of sulfide gases.
  - (d) Area with frequent fluctuation of voltage e.g. factory, etc.
  - (e) In vehicles or ships.
  - (f) Kitchen with heavy oil vapour or humidity.
  - (g) Near to the machine emitting electric-magnetic waves.
  - (h) Places with acid, alkali vapour. TV, radio, acoustic appliances etc are at least 1 m far away to the indoor unit, outdoor unit, power supply wire, connecting wire, pipes, otherwise images may be disturbed or noises be created.

## [Wiring]

Air-conditioner should be equipped with special power supply wire.

## [Operating noise]

- Chose the following locations:
  - (a) Capable of supporting air-conditioner weight, don't increase operating noise and vibration.
  - (b) Hot vapour from outdoor unit outlet and operating noise don't disturb neighbour.
- No obstacles around the outdoor unit outlet.

# Safety Precautions

## • Installation Precautions

### WARNING!

- ★ The area of the room in which R32 refrigerant air conditioner is installed cannot be less than the minimum area specified in the table below, to avoid potential safety problems due to out-of-limit of refrigerant concentration inside the room caused by leakage of refrigerant from refrigeration system of the indoor unit.
- ★ Once the horn mouth of connecting lines is fastened, it may not be used again (the air tightness may be affected).
- ★ A whole connector wire shall be used for indoor/outdoor unit as required in the operation specification of installation process and operation instructions.

Minimum Room Area

Type	LFL kg/m <sup>3</sup>	h <sub>0</sub> m	Total Mass Charged/kg Minimum Room Area/m <sup>2</sup>						
			1.224	1.836	2.448	3.672	4.896	6.12	7.956
R32	0.306	0.6		29	51	116	206	321	543
		1.0		10	19	42	74	116	196
		1.8		3	6	13	23	36	60
		2.2		2	4	9	15	24	40

# Remote Controller Operation Manual

English

## External View of Remote Controller

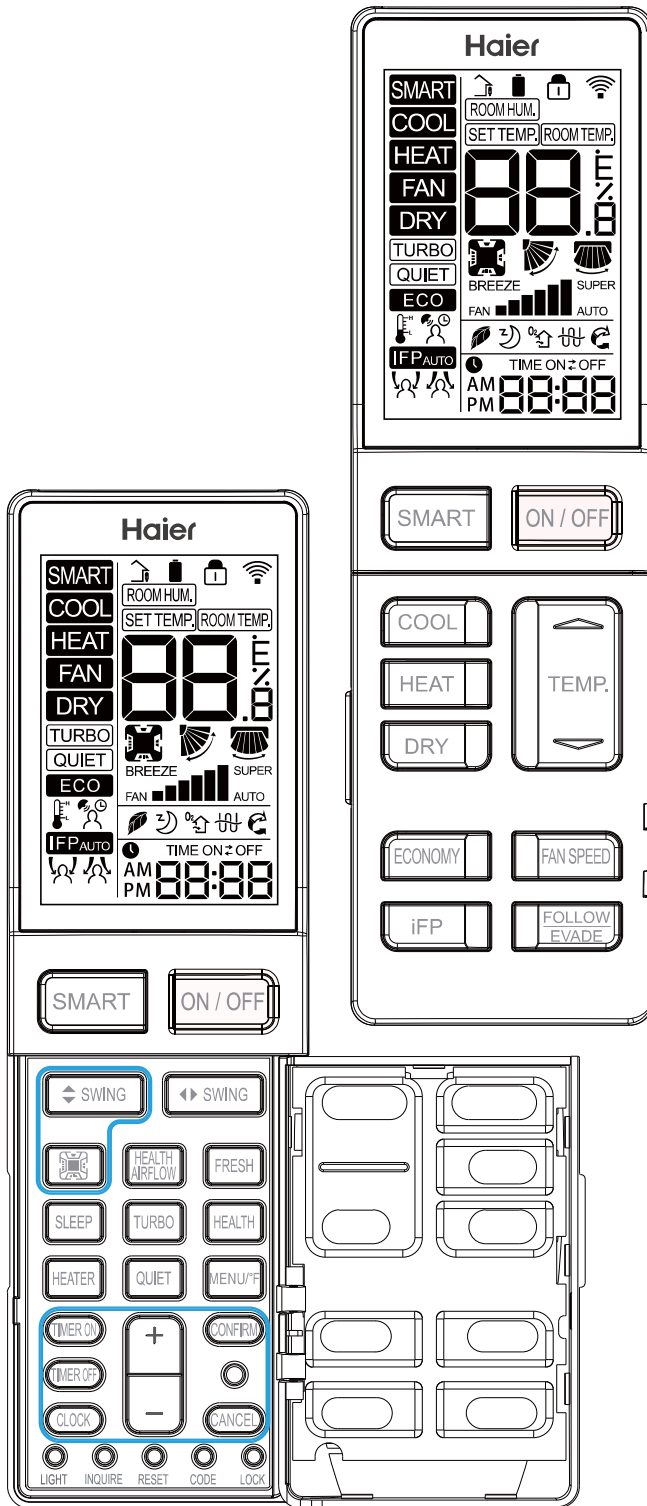

## Functional description

**1. Power-up and Show All:** After inserting the batteries the display will show all symbols for 3 seconds. The remote will then enter clock set mode. Use “+/-” to adjust the clock. Press “Confirm” when done. If no action is taken within 10 seconds then the remote will exit set mode. See section 22 for clock setting instruction.

**2. ON/OFF Button:** Press the ON/OFF button on the remote control to start the unit.

**3. SMART Button:**

(1) In SMART mode the air conditioner will automatically switch between Cool, Heat, or Fan to maintain set temperature.

(2) When the fan is set to AUTO the air conditioner automatically adjusts the fan speed according to room temperature.

(3) The SMART button also works to power the unit on and off.

**4. COOL Button, HEAT Button and DRY Button**

(1) In COOL mode, the unit operates in cooling. When FAN is set to AUTO, the air conditioner automatically adjusts the fan speed according to room temperature. COOL will be displayed during COOL mode.

(2) In HEAT mode, warm air will blow out after a short period of the time due to cold-air prevention function. When FAN is set to AUTO, the air conditioner automatically adjusts the fan speed according to room temperature. HEAT will be displayed during HEAT mode.

(3) DRY mode is used to reduce humidity. In DRY mode, when room temperature becomes lower than temp. setting+2°F, unit will run intermittently at LOW speed regardless of FAN setting. DRY will be displayed during DRY mode.

Mode	SMART	HEAT	COOL	DRY	FAN
Initial TEMP.	24°C (75°F)	24°C (75°F)	24°C (75°F)	24°C (75°F)	Setting temperature is not showed.
Mode	SMART	HEAT	COOL	DRY	FAN
Initial Fan Speed	AUTO	LOW	HI	AUTO	LOW

**5. FAN SPEED Button:**

Fan speed selection

Press FAN SPEED button. For each press, fan speed changes as follows:

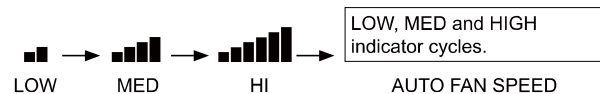

The air conditioner fan will run according to the displayed fan speed. When FAN is set to AUTO, the air conditioner automatically adjusts the fan speed according to room temperature.

**6. TEMP. +/- Buttons:**

Temp+ Every time the button is pressed, the temperature setting increases.

Temp- Every time the button is pressed, temperature setting decreases.

The operating temperature range is 60°F -86°F (16°C-30°C).

**7. Quadrant Control**

(Available for some models):



This setting allows the vertical airflow to be adjusted individually on each side of the unit.

(1) Initial default positions.

	SMART	HEAT	COOL	DRY	FAN
Selected Quadrant	Show all	Show all	Show all	Show all	Show all
Vertical SWING Angle	Position 3	Position 5	Position 3	Position 3	Position 3

(2) Press the Quadrant Control button to select the quadrant. Each button press will select as shown below:



(3) Once desired quadrant is selected then use the Vertical Swing button to set the direction of airflow. See section 9.

## Loading of the battery

1. Remove the battery cover;
2. Insert AAA batteries (included) loading is in line with the “+”/“-”;
3. Replace cover

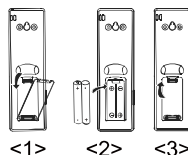

# Remote Controller Operation Manual

## 8. Vertical SWING Button

Air Flow Direction Adjustment

Press the SWING UP/DOWN button to choose the position of the vertical airflow louvers.

Status display of air flow

COOL/DRY

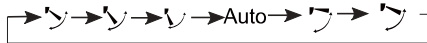

HEAT



## 9. Horizontal SWING Button

Press the SWING LEFT/DOWN button to choose the position of the horizontal airflow louvers.

Status display of air flow

COOL/DRY/HEAT:



## 10. HEALTH AIRFLOW (Available for some models):

Health Airflow function will stir the air in the room.

(1) Press the "HEALTH AIRFLOW" button to show  icon on LCD display.

(2) The Quadrant icon will cycle to each quadrant.

(3) Horizontal swing default is oscillate. It can be adjusted with each press of the Horizontal SWING Button between narrow, mid, wide and left to right.

(4) Vertical swing is not adjustable.

(5) Fan speed default is variable. It can be adjusted by pressing FAN SPEED Button between low, medium and high.

REMOVE IMAGES

## 11. Sleep Operation Mode:

1. SLEEP mode during COOL, DRY modes

One hour after SLEEP mode starts, the temperature will rise 2°F .above set temperature, after another hour, the temperature rises an additional 2°F. The unit will run for an additional six hours, then turns off. The final temperature is 4°F higher than the initial set temperature. Using this feature will help with achieving maximum efficiency and comfort from your unit while you sleep.

2. SLEEP mode during HEAT mode

One hour after SLEEP mode starts, the temperature will decrease 4°F below set temperature, after another hour, the temperature will decrease an additional 4°F. After an additional three hours, the temperature will rise by 2°F. The unit will run for an additional three hours, then turns off. The final temperature is 6°F lower than the initial set temperature. Using this feature will help with achieving maximum efficiency and comfort from your unit while you sleep.

3 In SMART mode

The unit operates in corresponding sleep mode adapted to the automatically selected operation mode.

Note:

When the TIMER ON function is set, the sleeping function cannot be set. If the sleeping function has been set, and the user sets the TIMER ON function, the sleeping function will be canceled, and the unit will be set to the timer function.

## 12. HEALTH:

(1) During power-on or power-OFF, press "HEALTH" button to display icon  on LCD display, and press "HEALTH" button again to cancel.

(2) During power-OFF, press "HEALTH" button to enter Fan mode, start low wind and HEALTH function, display icon .

(3) Switch among modes, and keep HEALTH function.

(4) If HEALTH function is set, power OFF and then on to stay in HEALTH mode.

(5)HEALTH function is not available for some units.

## 13. ECO:

(1) Press ECO button and the display will show .

(2) ECO is valid under all modes, it is memorized among switch of all modes.

(3) ECO function power-on or power-OFF is memorized.

(4)ECO function is not available for some units.

## 14. Turbo/Quiet:

The TURBO function is used for fast heating or cooling.

Press TURBO button, the remote control will display the TURBO and switch the fan to SUPER high. Press TURBO button again to cancel function.

Press QUIET button, the remote control will display the QUIET and switch fan to BREEZE. Press QUIET button again to cancel function.

Note:

TURBO/QUIET modes are only available when the unit is under cooling or heating mode (not for smart or dry mode).

Running the unit in QUIET mode for a long period of time may cause the room temperature to not reach the set temperature. If this occurs, cancel QUIET mode and set the fan speed to a higher setting.

## 15. Requires optional motion sensor part

(1) Smart Focal Point (iFP) will operate the unit at set point only when the room is occupied.

## 16. Evade/Follow

When the iFP sensor is installed the airflow can be set to follow occupants or evade them.

## 17. FRESH:

(1) FRESH function is valid under the state of ON or OFF. When air conditioner is OFF, press "FRESH" button, display icon  on LCD display to enter Fan mode and low speed. Press "FRESH" button again, this function is cancelled.

(2) After FRESH function is set, ON or OFF functions are kept.

(3) After FRESH function is set, mode switch function is kept.

(4) FRESH function is not available for some units.

## 18. °C/°F function

Press "MENU/°F" to toggle between [set temp]°F; [set temp]°C; and 10°C/50°F Low Temperature Heating mode. Low Temperature Heating is only available when set to HEAT. When set to Low Temperature Heating, the set point is dropped to a minimum temperature to prevent damage from freezing temperatures.

## 19. HEATER:

(1) When HEAT mode is chosen and  is displayed on LCD display, pressing "HEATER" button can cancel and set HEATER function.

(2) Auto mode will not start HEATER function automatically, but can set or cancel HEATER function.

(3) HEATER function is not available for some units.

## 20. Timer:

ON-OFF Operation

1. Start the unit and select the desired operating mode.

2. Press the TIMER OFF button to enter TIMER OFF mode. The remote control will start flashing "OFF", adjusting time by "+/-" button.

3. Once the desired timer is selected for the unit to turn off, press the CONFIRM button to confirm this setting.

Cancel TIMER OFF setting:

With a TIMER OFF set, press the CANCEL button once to cancel the TIMER OFF.

Note:

Holding the "+/-" button down will rapidly adjust the time. After replacing batteries or a power failure occurs, the time setting will need to be reset.

According to the Time setting sequence of TIMER ON or TIMER OFF, either Start-Stop or Stop-Start can be achieved.

## 21. Button +/-:

"+" Every time the button is pressed, the time increases 1 minute.

"-" Every time the button is pressed, the time decreases 1 minute.

Holding the "+" or "-" button down will rapidly adjust the time.

## 22. Clock:

Press "Clock" button, "AM" or "PM" will flash when remote is in clock set mode. Use "+/-" to set mode. Use "Clock" mode. Use M to adjust clock and then press "CONFIRM" to exit set mode.

## 23. LIGHT:

Turns indoor unit display on and off.

## 24. RESET:

If the remote control is not functioning properly, use a pen point or similar object to depress this button to reset the remote.

## 25. LOCK:

Used to lock buttons and LCD display.

26. CODE: Function reserved.

27. INQUIRE Function reserved.

# Special functions and instructions

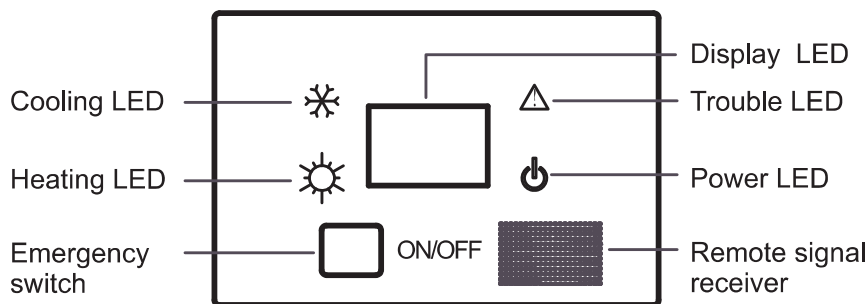

## Emergency operation of indoor unit

- When the remote controller is lost or damaged, the emergency switch can be operated under the panel. (as shown in the figure).
- In the OFF state, pressing the emergency switch can turn on automatic operation. Air conditioning automatically selects operation mode according to indoor temperature (cooling or heating).
- However, temperature setting and wind speed can not be changed. In the ON state, press this button to stop the air conditioner.

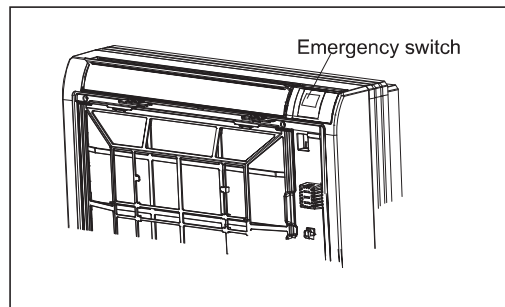

## Indoor air supply control

### CAUTION

Before opening the front grille, be sure to stop the operation and turn the breaker OFF.  
Do not touch the metal parts on the inside of the indoor unit, as it may result in injury.

- Regardless of the operating mode or situation, air blows from the upper air outlet.
- Use this switch when you do not want air coming out of lower air outlet. (While sleeping etc..)

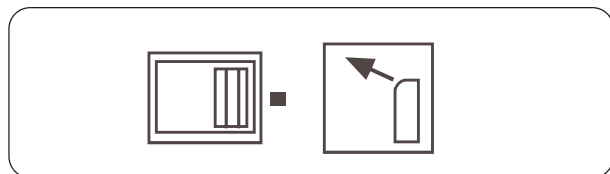

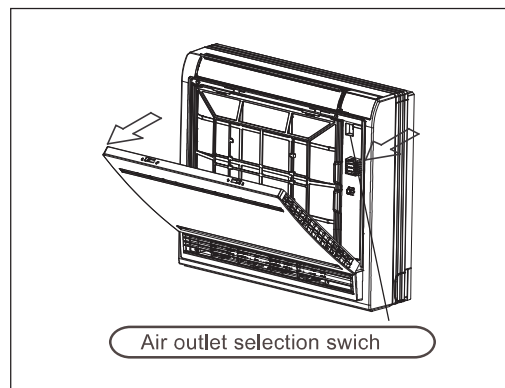
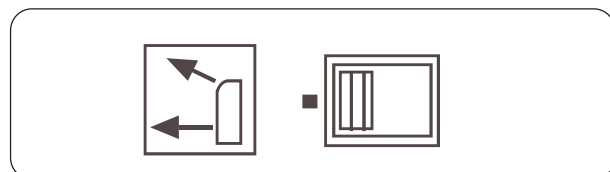

- Air conditioner automatically decides the appropriate blowing pattern depending on the operating mode and situation.
- During Cool/Dry and Fan mode, so that cold air does not come into direct contact with people, air is blown upper air outlet.



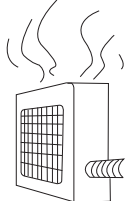
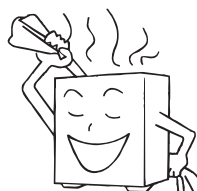

# Troubleshooting

The followings are not malfunction

<p>Water flowing sound is heard</p> 	<p>When the air conditioner is started, when the compressor starts or stops during operation or when the air conditioner is stopped, it sometimes sounds "Bi- Bi-" or "Godo-Godo". It is the flowing sound of the refrigerant, not a malfunction.</p>
<p>Cracking sound is heard</p>	<p>This is caused by heat expansion or contraction of plastics</p>
<p>It smells.</p>	<p>Air blown out from the indoor unit sometimes smells. The smell results from smells of furniture, paint, tobacco absorbed by indoor unit.</p>
<p>During operation, white fog comes out of indoor unit.</p> 	<p>When in COOL or DRY mode, a thin water fog can be seen blown out of unit, this is the condensed fog because the suddenly cooled indoor air is blown out.</p>
<p>Automatically switch into FAN mode during cooling.</p>	<p>To prevent frost from being accumulated on the indoor unit heat exchanger, it sometimes automatically switched into the FAN mode, but it will soon back to the cooling mode.</p>
<p>The air conditioner cannot be restarted soon after it stops. Air conditioner does not start?</p> 	<p>This is because of the self-protection function of the system, therefore, it cannot be restarted for about three minutes after it stops. Please wait for three minutes</p>
<p>Air does not blow or the fan speed cannot be changed during drying.</p>	<p>In DRY mode, when room temperature becomes 2°C higher than temperature setting, unit will run intermittently at LO speed regardless of FAN setting</p>
<p>Water or vapor generated from the outdoor unit during heating.</p> 	<p>This happens when the frost accumulated on the outdoor unit is removed (during defrosting operation).</p>  <p style="text-align: center;">Defrosting operation</p>
<p>During heating, indoor fan is still running even unit is stopped.</p>	<p>To get rid of the excess heat, indoor fan will continue running for a while after unit automatically stops.</p>





Please check the following things about your air conditioner before making a service call.

Unit fails to start.		
<p>Is the power supply switch on ?</p>  <p>Power supply switch is not in ON position.</p>	<p>Is city supply power normal ?</p> 	<p>Is the earth leakage breaker in action ?</p> <p>Be sure to turn off the power supply switch immediately and contact the sales dealer.</p>

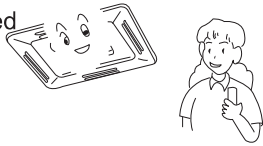
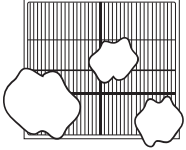

# Troubleshooting

## Insufficient cooling or heating

<p>The operation controller adjusted as required</p> 	<p>Air filter too dirty ?</p> 	<p>Horizontal swing louver upward ? (in HEAT mode)</p> 
<p>Any obstacle exists at the air inlet or outlet?</p> 	<p>Door or window left opened ?</p> 	

## Insufficient cooling

<p>Any other heat sources in the room?</p> 	<p>Sunlight direct into the room ?</p> 	<p>Too crowded in the room ?</p> 
--	--	--

## Cooled air blown out ( when heating)

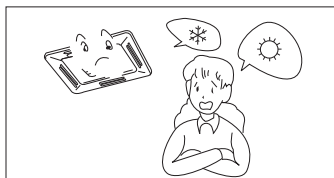

When the air conditioner does not operate properly after you have checked the above-mentioned items or when following phenomenon is observed, stop the operation of the air conditioner and contact your sales dealer.

- 1)The fuse or breaker often shuts down.
- 2)Water drops off during cooling or drying operation.
- 3)There is an irregularity in operation or abnormal sound that is audible.

## INDOOR UNIT TROUBLE SHOOTING

LED flash times of indoor PCB		Malfunction display	Contents of Malfunction	Possible reasons
LED6	LED1			
0	1	E1	Malfunction of indoor unit ambient temperature sensor	Sensor disconnected, or broken, or at wrong position, or short circuit
0	2	E2	Malfunction of indoor unit piping temperature sensor	Sensor disconnected, or broken, or at wrong position, or short circuit
0	4	E4	EEPROM wrong of indoor PCB	EEPROM chip disconnected or broken or wrong programmed, or PCB broken
0	7	E7	Abnormal communication between indoor and outdoor units	Wrong connection, or the wires be disconnected or wrong address setting of indoor unit or faulty power supply or faulty PCB or slave unit malfunction in MAXI system
0	8	E8	Abnormal communication between wired controller and indoor unit	Wrong connection or wired controller broken, or PCB faulty
0	12	E10	Malfunction of drain system	Pump motor disconnected or at wrong position, or the float switch disconnected or at wrong position, or the short circuit bridge disconnected
0	13	C1	Zero cross signal wrong	Zero cross signal detected wrong
0	14	E14	Indoor unit DC fan motor abnormal	DC Fan motor disconnected or DC Fan broken or circuit broken

Note:

1. The outdoor failure can also be indicated by the indoor unit, the checking method as follows: LED6 flash times stands for tens digit, and LED1 flash times stands for units digit, use this bidigitate figure minus 20, then will get the outdoor error code. For example, if the outdoor error code is 15, LED6 will flash 3 times firstly, two seconds later, LED1 will flash 5 times, and four seconds later the process will repeat again.



2. LED6 is a green one on the indoor PCB, LED1 is a yellow one.

3. To get much more details about the outdoor unit failure, please refer to the outdoor unit trouble shooting list.

# Customer Need-to-know



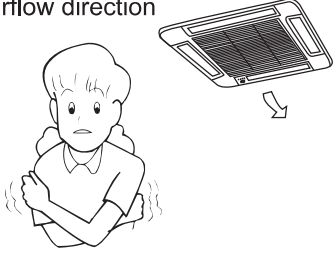

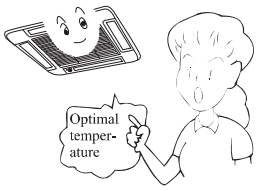
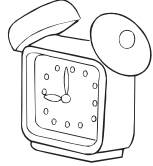

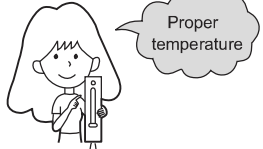
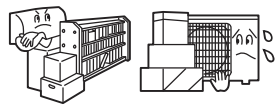

## Customer Need-to-know

- Please install the air conditioner according to the requirements specified in this manual to ensure the air conditioner work well.
- Be careful not to scratch the surface of the case during moving the air conditioner.
- Please keep the installation manual for future reference when maintenance and changing installation place.
- After installation ,please use the air conditioner according to the specification in the operation manual.

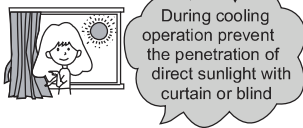
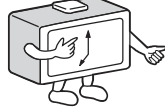

Using Directions	
<p>Adjust suitable airflow direction</p> 	<p>Avoid direct sunlight and airflow</p> 
<p>Keep the proper indoor temperature. Too cool or hot is not good for your health. Furthermore, it will result in excessive consumption of electric power.</p> 	<p>Effectively use timer. Using TIMER mode, you can make the room temperature reach a suitable temperature when you wake up or back home.</p> 

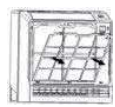
# Maintenance

## Clean the unit

<p>Setting of proper room temperature</p> 	<p>Do not block the air inlet or outlet</p> 	<p>Remote Controller</p>  <p>Do not use water, wipe the controller with a dry cloth. Do not use glass cleaner or chemical cloth.</p>	<p>Indoor Body</p>  <p>wipe the air conditioner by using a soft and dry cloth. For serious stains, use a neutral detergent diluted with water. Wring the water out of the cloth before wiping, then wipe off the detergent completely.</p>
<p>Close doors and windows during operation</p> 	<p>Use the timer effectively</p> 	<p>Do not use the following for cleaning</p>  <p>Gasoline, benzene, thinner or cleanser may damage the coating of the unit.</p>  <p>Hot water over 40°C(104°F) may cause discoloring or deformation.</p>	
<p>If the unit is not to be used for a long time, turn off the power supply main switch.</p> 	<p>Use the louvers effectively</p> 	<p>Air Filter cleaning</p>  <ol style="list-style-type: none"> <li>1 Open the inlet grille by pulling it upward.</li> <li>2 Remove the filter. Push up the filter's center tab slightly until it is released from the stopper, and remove the filter downward.</li> <li>3 Clean the filter. Use a vacuum cleaner to remove dust, or wash the filter with water. After washing, dry the filter completely in the shade.</li> <li>4 Attach the filter. Attach the filter correctly so that the "FRONT" indication is facing to the front. Make sure that the filter is completely fixed behind the stopper. If the right and left filters are not attached correctly, that may cause defects.</li> <li>5 Close the inlet grille.</li> </ol> 	

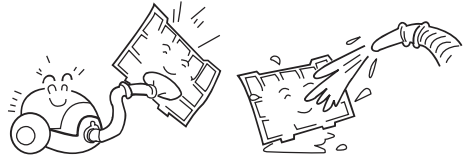
English

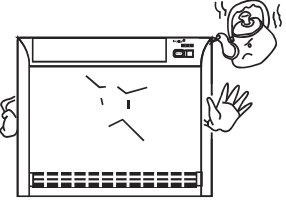
<p>Clean the filter</p> <p>Use water or vacuum cleaner to remove dust. If it is too dirt, clean with detergent or neutral soap water. Rinsing with fresh water, dry the filter and re-assemble.</p>	
<p>Caution</p> <p>Do not wash filter in hot water above 40 °C, which will damage the filter. Do carefully wipe the filter.</p>	
<p>Clean the indoor(outdoor) unit</p> <p>Clean with warm cloth or neutral detergent, then wipe away moisture with dry cloth. Do not use too hot water(above 40 °C), which will cause discoloration or deformation. Do not use pesticide or other chemical detergents.</p>	

# Installation Procedure

## CAUTIONS:

To ensure proper installation, read "Cautions" carefully before working. After installation, start the unit correctly and show customers how to operate and maintain the unit.

## Meanings of Warning and Cautions:

⚠ **WARNING:** Serious injury or even death might happen, if it is not observed.

⚠ **CAUTION:** Injury to people or damages to machine might happen, if it is not observed.

### ⚠ **WARNING:**

- Installation shall be done by professional people, don't install unit by yourself. Incorrect installation will cause water leakage, electric shock or fire.
- Install unit as per the Manual. Incorrect installation will cause water leakage, electric shock or fire accident.
- Be sure to use specified accessories and parts. Otherwise, water leakage, electric shock, fire accident or unit falling down may happen.
- Unit should be placed on a place strong enough to hold the unit. Or, unit will fall down causing injuries.
- When install the unit, take in consideration of storms, typhoon, earthquake. Incorrect installation may cause unit to fall down.
- All electric work shall be done by experienced people as per local code, regulations and this Manual.
- Use exclusive wire for the unit. Incorrect installation or undersized electric wire may cause electric shock or fire accident.
- All the wires and circuit shall be safe. Use exclusive wire firmly fixed. Be sure that external force will not affect terminal block and electric wire. Poor contact and installation may cause fire accident.
- Arrange wire correctly when connecting indoor and outdoor power supply. Fix terminal cover firmly to avoid overheat, electric shock or even fire accident.
- In case refrigerant leakage occurred during unit installation, keep a good ventilation in the room.
- Poisonous gas will occur when meet with fire.
- Check the unit upon installation. Be sure there is no leakage. Refrigerant will induce poisonous gas when meet heat source as heater, oven, etc.
- Cut power supply before touching terminal block.

### ⚠ **CAUTION:**

- Unit shall be grounded. But grounding shall not be connected to gas pipe water pipe, telephone line. Poor grounding will cause electric shock.
- Be sure to install a leakage breaker to avoid electric shock.
- Arrange water drainage according to this Manual. Cover pipe with insulation materials in case dew may occur. Unproper installation of water drainage will cause water leakage and wet your furniture.
- To maintain good picture or reduce noise, keep at least 1 m from T.V. radio, when install indoor and outdoor unit, connecting wire and power line. (If the radio wave is relatively strong, 1 m is not enough to reduce noise).
- Don't install unit in following places:
  - (a) Oil mist or oil gas exists, such as kitchen, or, plastic parts may get aged, or water leakage.
  - (b) Where there is corrosive gas. Copper tube and welded part may be damaged due to corrosion, causing leakage.
  - (c) Where there is strong radiation. This will affect unit's control system, causing malfunction of the unit
  - (d) Where flammable gas, dirt, and volatile matter (thinner, gasoline) exist, These matter might cause fire accident.
- Refer to paper pattern when installing unit.



Earthing

### **Cautions for the installation personnel**

Don't fail to show customers how to operate unit.

# Installation Procedure

## ❶ BEFORE INSTALLATION <Don't discard any accessories until comp>

- Determine the way to carry unit to installation place.
- Don't remove packing until unit reaches installation place.
- If unpacking is unavoidable, protect unit properly.

## ❷ SELECTION OF INSTALLATION PLACE

(1) Installation place shall meet the following and agreed by customers:

- Place where proper air flow can be ensured.
- No block to air flow.
- Water drainage is smooth.
- Place strong enough to support unit weight.
- Place where inclination is not evident on ceiling.
- Enough space for maintenance.
- Indoor and outdoor unit piping length is within limit. (Refer to Installation Manual for outdoor unit.)
- Indoor and outdoor unit, power cable, inter unit cable are at least 1 m away from T.V. radop. This is helpful to avoid picture disturbance and noise. (Even if 1 m is kept, noise can still appear if radio wave is strong)

## ❸ DRAWING FOR THE INSTALLATION OF INDOOR UNITS

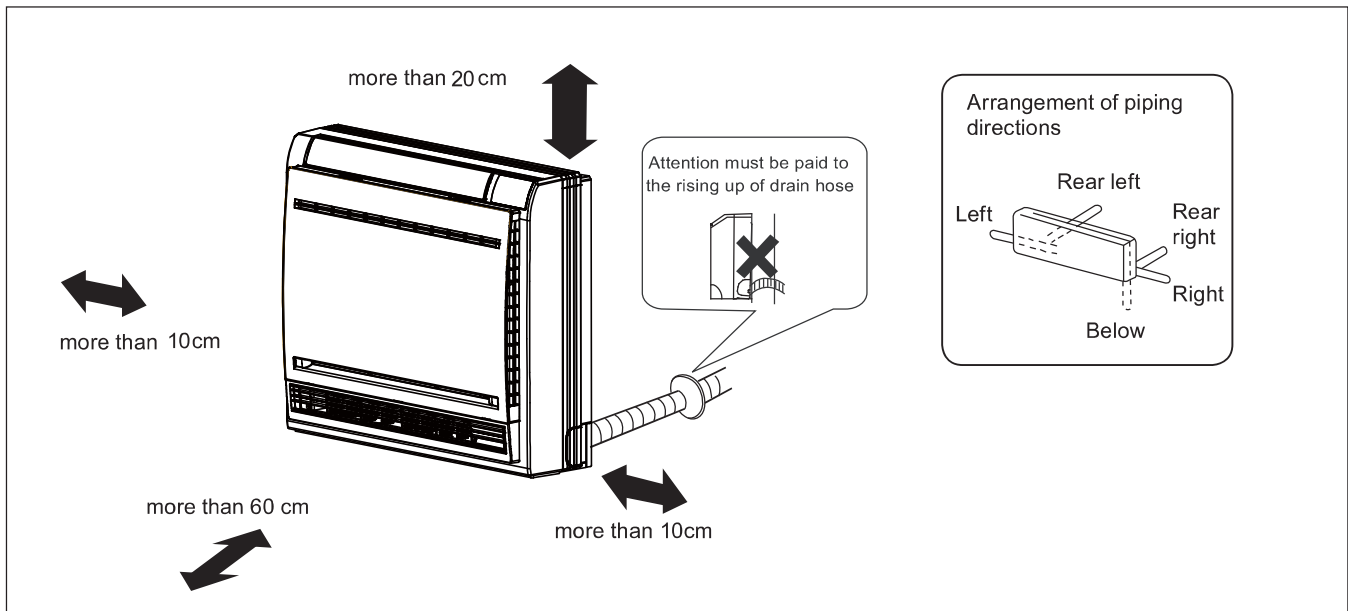

# Installation Procedure

## Indoor Unit Installation

### (1) Making a Hole on the Wall and Fitting the Piping Hole Cover

- Make a hole of 55mm in diameter, slightly descending to outside the wall.
- Install piping hole cover and seal it off with putty after installation.

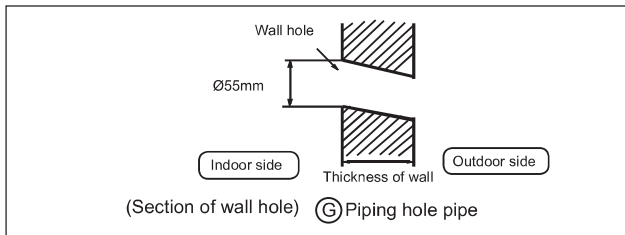

### (2) Installation of the Indoor Unit

#### Removal of Front Grille

- Hole the front panel by the tabs on the both sides and lift it until it stops with a click.

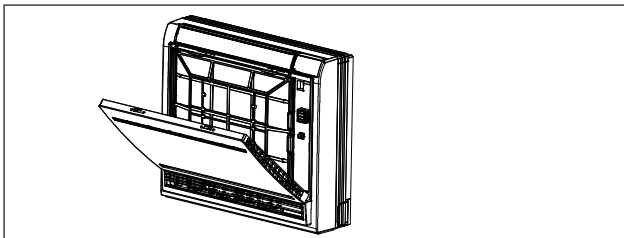

- Loosen the marked four screws and open the grille.

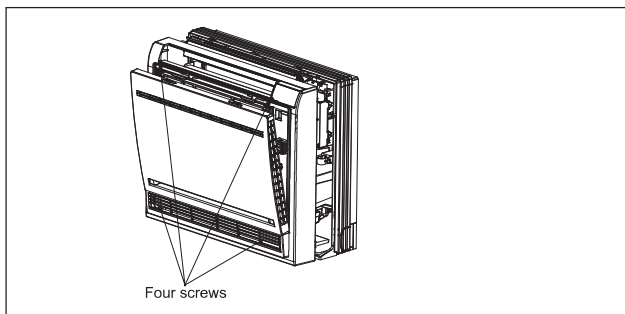

#### Drawing of pipe

##### [Rear piping]

- Draw pipes and the drain hose, then fasten them with the adhesive tape.

##### [Left-Left-rear piping]

- In case of left side piping, cut away, with a nipper, the lid for left piping.
- In case of left-rear piping, bend the pipes according to the piping direction to the mark of hole for left-rear piping which is marked on heat insulation materials.
  1. Insert the drain hose into the dent of heat insulation materials of indoor unit.
  2. Insert the indoor/outdoor electric cable from backside of indoor unit, and pull it out on the front side, then connect them.

- 3. Coat the flaring seal face with refrigerant oil and connect pipes.

Cover the connection part with heat insulation materials closely, and make sure fixing with adhesive tape.

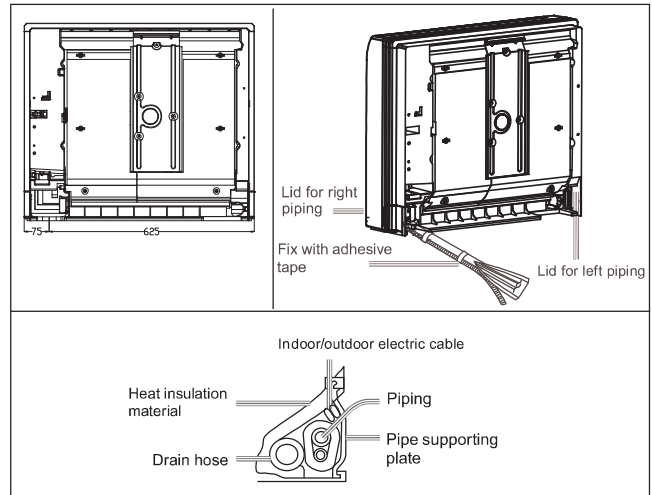

- Indoor/outdoor electric cable and drain hose must be bound with refrigerant piping by protecting tape. [Other direction piping]
- Cut away, with a nipper, the lid for piping according to the piping direction and then bend the pipe according to the position of wall hole, When bending, be careful not to crash pipes.
- Connect beforehand the indoor/outdoor electric cable, and then pull out the connected to the heat insulation of connecting part specially.

# Installation Procedure

## Fixing the indoor unit body

Indoor installation can be done in any of the following two ways:

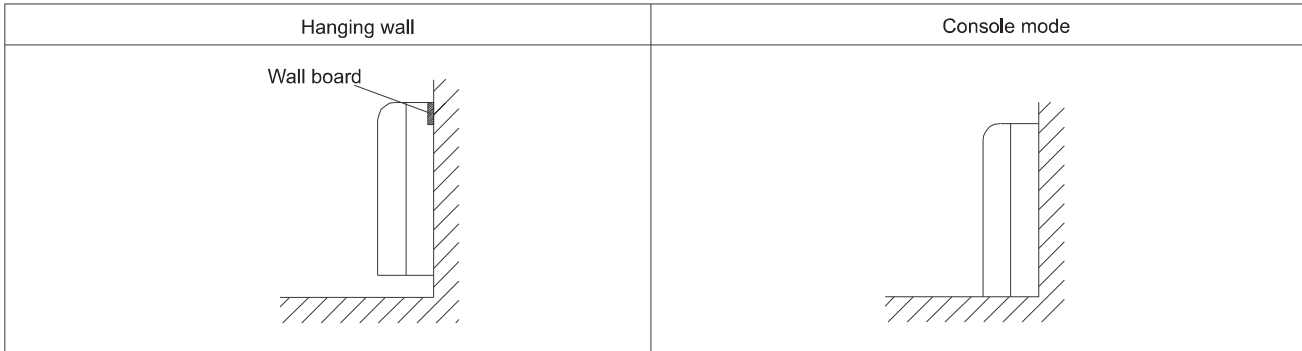

- Fix the wall board, then use four screws to fix the unit on the wall. As the figure shown.

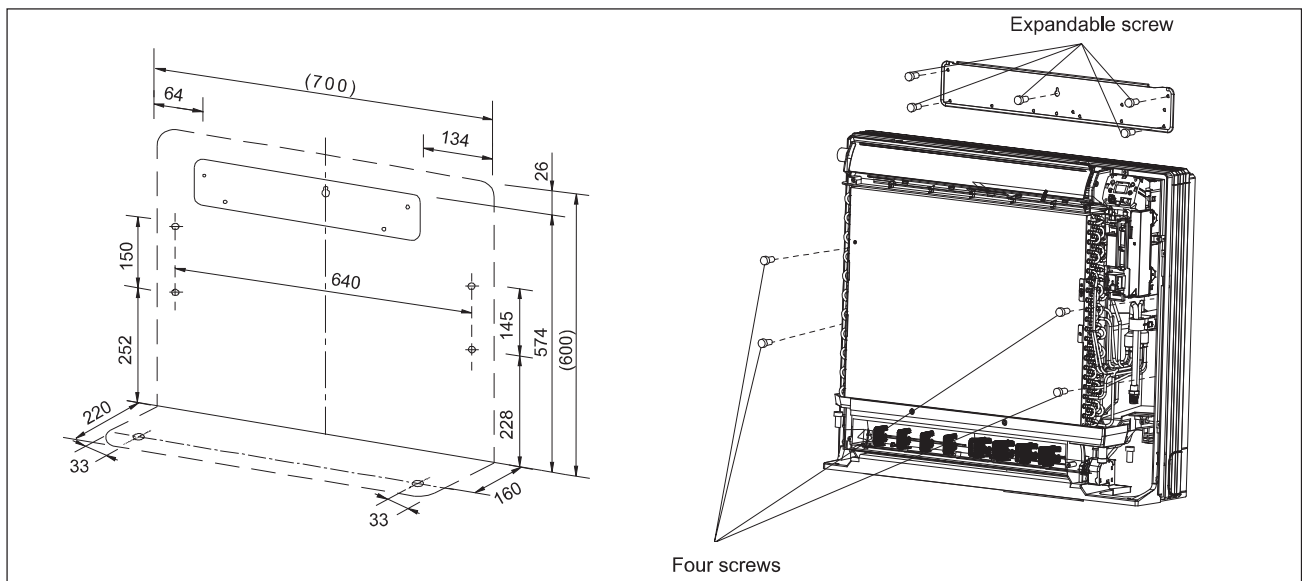

- Remove the front panel, then use two fastening screws to fix the unit on the floor. As the figure shown.

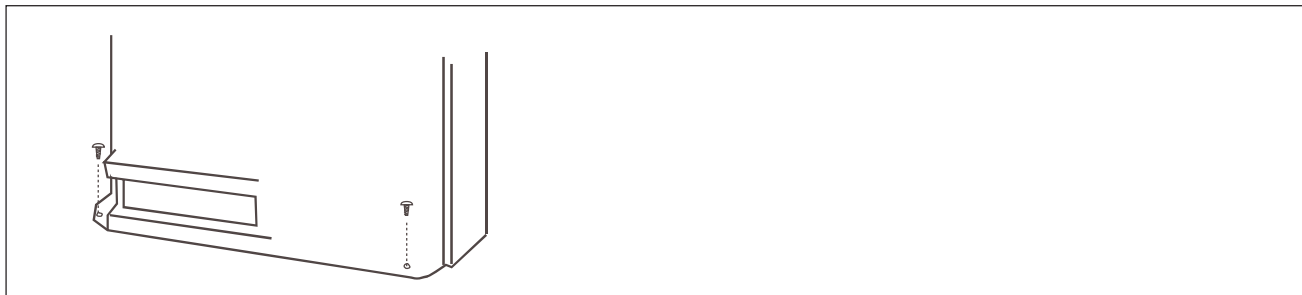

- Once refrigerant piping and drain piping connections are complete, fill the gap of the through hole with putty. Attach the front panel and front grille in their original positions once all connections are complete.

# Installation Procedure

## 4 REFRIGERANT PIPING (As for outdoor piping, please refer to installation Manual of outdoor unit.)

- Outdoor is precharged with refrigerant.
- Be sure to see the Fig.1, when connecting and removing piping from unit.
- For the size of the flare nut, please refer to Table 1.
- Apply refrigerant oil at both inside and outside of flare nut. Tighten it band tight 3-4 turns then tighten it.
- Use torque specified in Table 1. (Too much force may damage flare nut, causing gas leakage).
- Check piping joints for gas leakage. Insulate piping as shown in Fig. below.
- Cover joint of gas piping and insulator ⑦ with seal.

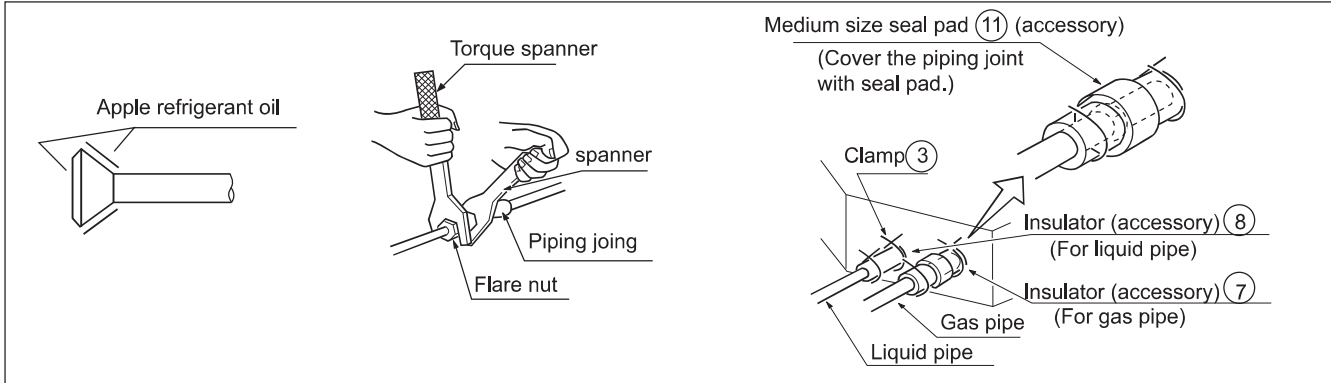

### Pipe size

Model	Liquid side	Gas side
AD25S2SD1FA	Ø6.35mm	Ø9.52mm
AD35S2SD1FA		
AD42S2SD1FA		

Table 1

Pipe size	Tighten torque	A(mm)	Flare shape
φ6.35	1420~1720N.cm (144~176kgf.cm)	8.3~8.7	
φ9.52	3270~3990N.cm (333~407kgf.cm)	12.0~12.4	
φ12.7	4950~6030N.cm (490~500kgf.cm)	12.4~16.6	
φ15.88	6180~7540N.cm (630~770kgf.cm)	18.6~19.0	
φ19.05	9720~11860 N.cm (990~1210 kgf.cm)	22.9~23.3	

## 5 INSTALLATION OF WATER DRAINAGE PIPE

### (1) Install water drainage pipe

- Pipe dia, shall be equal or larger than that of unit piping.(pipe of polyethylene; size: 20mm; O.D:26mm)
- Drain pipe should be short, with a downward slope at least 1/100 to prevent air bag from happening.
- If downward slope can't be made, take other measures to lift it up.

- Please install the drain hose so as to be downward slope without fail.
- Please don't do the drainage as shown below.

- Please pour water in the drain pan of the indoor unit, and confirm that drainage is carried out surely to outdoor.
- In case that the attached drain hose is in a room, please apply heat insulation to it without fail.

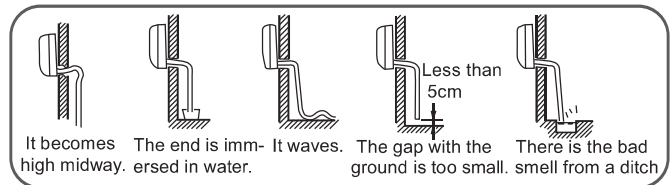

- Use the self-provided stiff pipe and clamp with unit. Insert water pipe into water plug until it reaches the white tape.
- Insulate drain hose in the room.





# Installation Procedure

## ⑥ WIRING CONNECTION

Make wiring to supply power to the outdoor unit, so that the power for the indoor unit is supplied by terminals.

The specification of power cable is H05RN-F3G 4.0mm<sup>2</sup>

The specification of cable between indoor unit to outdoor unit is H05RN-F4G 2.5mm<sup>2</sup>

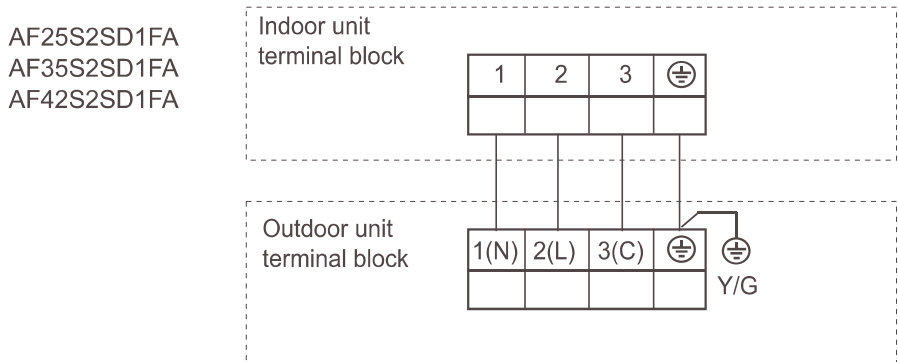

**⚠ WARNING:**  
Observe the following when connecting power supply terminal block:  
Don't connect wires of different specifications to the same terminal block.  
(Loose wire may cause overheating of circuit)  
Connect wires of same specifications as shown in right Fig.

Connect wires of the same specifications at two sides.

○

Don't connect wires of the same specifications at one side.

×

Don't connect wires of the different specifications.

×

## ⑦ WIRING EXAMPLE

As for outdoor unit circuit, please see Installation Manual of outdoor unit.

Note: All electric wires have their own poles, poles must match that on terminal block.

### Pay special care to the following and check after installation

Item to the checked	Unproper installation may cause	Check
Is indoor unit firmly installed?	Unit might fall down, make vibration or noise.	
Is gas leakage check performed?	This may lead to gas shortage.	
Is unit properly insulated?	Dew or water drop may occur.	
Is water drainage smooth?	Dew or water drop may occur.	
Is power voltage meet that stipulated on the nameplate?	Problem may occur or parts got burned.	
Is wiring and piping correctly arranged?	Problem may occur or parts got burned.	
Is unit safely grounded?	There might be a danger of electric shock.	
Is wire size correct?	Problem may occur or parts got burned.	
Are there any obstacles on air inlet and outlet grill of indoor and outdoor unit?	This may cause poor cooling.	
Is record made for piping length and refrigerant charging amount?	It is hard to control refrigerant charging amount.	

**Attention:** after finishing installation, confirm no refrigerant leakage.