

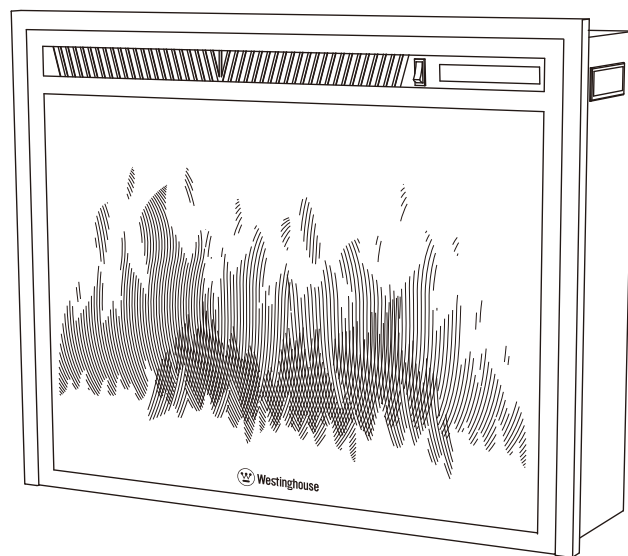

# User Manual

## ELECTRIC FIREPLACE

Model No.: □ WTH-28EF09A2



### CONSUMER SAFETY INFORMATION

- Read this manual before installing and operating this appliance.
- Failure to follow these instructions may result in electric shock, fire, or personal injury
- Do not store or use gasoline or other flammable liquids in the vicinity of this appliance.



® and WESTINGHOUSE are trademarks of Westinghouse Electric Corporation. Used under license by Westinghouse Fireplace (Ningbo) Co., Ltd. All Rights Reserved

**CONTACT US : [fireplace@efp.westinghouse.com](mailto:fireplace@efp.westinghouse.com)**

# CONTENTS

|  |           |
|--|-----------|
| <b>1. NOTICETOUSERS -----</b>            | <b>01</b> |
| <b>2. PARTSANDHARDWARE -----</b>         | <b>03</b> |
| <b>3. PRODUCT DIMENSIONS -----</b>       | <b>03</b> |
| <b>4. INSTALLATIONANDASSEMBLY-----</b>   | <b>04</b> |
| <b>5. CONTROLDESCRIPTION -----</b>       | <b>06</b> |
| <b>6. REMOTECONTROLDESCRIPTION -----</b> | <b>09</b> |
| <b>7. WI-FILINKCONTROL -----</b>         | <b>13</b> |
| <b>8. CAREANDMAINTENANCE-----</b>        | <b>16</b> |
| <b>9. ELECTRICALSCHEMATICS-----</b>      | <b>18</b> |
| <b>10. CUSTOMERSUPPORT-----</b>          | <b>19</b> |

# IMPORTANT SAFETY INFORMATION!



## WARNING



- **Read all instructions before using this heater!**
- This heater is hot **when in use**. To avoid burns, **DO NOT** let bare skin touch hot surfaces. If provided, use handles when moving this heater. Keep **combustible materials**, such as furniture, pillows, bedding, papers, clothes, and curtains at least **3 feet (0.9 m)** from the front of the heater, and **keep them away from the sides and rear**.
- **Extreme caution** is necessary when any heater is used by or near children or vulnerable individuals and whenever the heater is left **operating and unattended**.
- **DO NOT** operate any heater with a **damaged cord or plug**, or after the **heater malfunctions** or has been **dropped or damaged in any manner**. Discard heater, or return to authorized service facility for examination and/or repair.
- **DO NOT** run power cord under carpeting. **DO NOT** cover power cord with throw rugs, runners, or similar coverings. **DO NOT** route power cord under furniture or appliances. Arrange power cord away from **high-traffic areas**, where it will not be tripped over.



## WARNING



- **Connect to properly grounded outlets ONLY.**
- **DO NOT** insert or allow foreign objects to **enter any ventilation or exhaust openings**, as this may cause **electric shock or fire, or damage the heater**.
- To prevent a possible fire, **DO NOT** block air intakes or exhaust in any manner. Doing so could cause a fire. **DO NOT** use on soft surfaces, like a bed, where openings may become blocked.
- A heater has **hot and arcing or sparking parts inside**. **DO NOT** use it in areas where **gasoline, paint, or flammable liquids** are used or stored.
- **Use this heater only as described in this manual. Any other use not recommended by the manufacturer may cause fire, electric shock, or injury to persons.**
- **ALWAYS** plug heaters directly into a wall outlet/receptacle. **Never use with an extension cord or relocatable power tap (outlet/power strip).**
- **DO NOT** place the heater near a bed because objects such as pillows or blankets can fall off the bed and be ignited by the heater.
- **NEVER** use this heater in **bathrooms, laundry rooms**, or in any other location where the heater could fall into a **bathtub or pool, become damp, or come into contact with water**.
- **TO AVOID FIRE**, regularly inspect all air vents to make sure they are free from dust, lint, or other blockages. **Unplug the unit** and clean with a **vacuum ONLY**. **DO NOT** rinse or get wet.
- **ALWAYS** mount to wall bracket before use. **DO NOT** set on the floor, or other surface, to use.

- **NEVER** use a wall mount bracket from another manufacturer.
- This product is **not intended** to be a **primary heat source**. It is for **supplemental heat only**.
- **INDOOR use only! NEVER** use this heater **outdoors!** Doing so may result in **electric shock!**
- **Risk of electric shock! DO NOT OPEN!** No user-serviceable parts inside!
- **ALWAYS** turn this heater off before unplugging it from the outlet.
- **ALWAYS disconnect** this unit from the **power supply before** performing any assembly or cleaning, or before relocating the electric fireplace.
- **NEVER** leave this heater unattended. **ALWAYS** unplug this heater when not in use.
- **ALWAYS** store this heater in a dry location. **NEVER** use the fireplace if it has become wet.
- **NEVER** plug this heater into an outlet that is **old, cracked,** or has any **loose wires or connections**. Plugging this heater into a faulty outlet could result in **electric arcing** within the outlet that could cause the **outlet to overheat or catch fire**.
- **ALWAYS** check your heater cord and plug connections with **each use!**
  - i) **MAKE SURE** the plug fits tightly into the outlet! Faulty wall outlet connections or loose plugs can cause the outlet to overheat.
  - ii) **Heaters draw more current** than small appliances. **Overheating** may occur even if it has not occurred with the use of other appliances.
  - iii) During use, **check frequently** to see if the **plug outlet or face plate is HOT!**
- iv) If the outlet or face plate is **HOT, discontinue use immediately** and have a qualified electrician inspect and/or replace the faulty outlets.
- The power cord supplied with the heater has a plug with two flat blades (live and neutral) and one round pin (ground). If a 3-slot receptacle is not available, an adapter **MUST** be used. The adapter **MUST** be **properly grounded** to the outlet box (see figure to the right). (Note: Adapter NOT INCLUDED.)
- **SAVE THESE INSTRUCTIONS!**

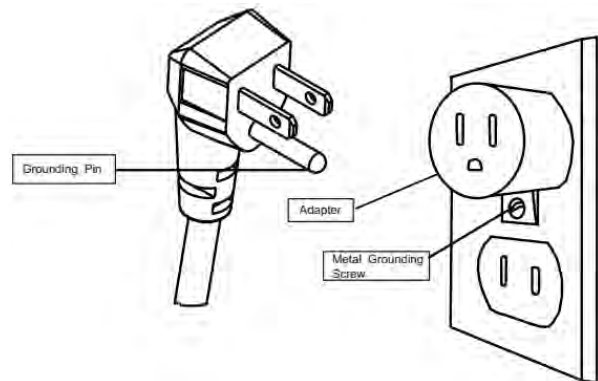



## PREPARATION



This product includes a **GLASS panel!** Always use **extreme caution** when handling **glass**. Failure to do so could result in **personal injury or property damage**.

Remove all parts and hardware from the box and place them on a clean, soft, dry surface. Parts and assembly steps are grounded for wall-hanging or recessing use. Check the parts list to make sure nothing is missing. Dispose of packaging materials properly. Please recycle whenever possible. You will need the following tools (not included): Phillips screwdriver; stud finder; level; tape measure; electric drill; battery; 1/4 wood drill bit, hammer.

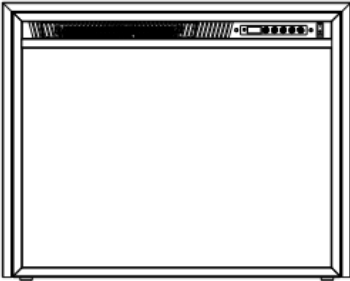
# PARTS & HARDWARE

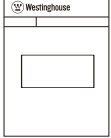
|   |  |   |  |
|---|--|---|--|
|  <p>A. Fireplace</p> |  <p>B. 4x12mm Screws<br/>(4pcs)</p> |  <p>C. Remote Control</p> |  <p>D. Instructions</p> |
|---|--|---|--|

# SPECIFICATIONS AND DIMENSIONS

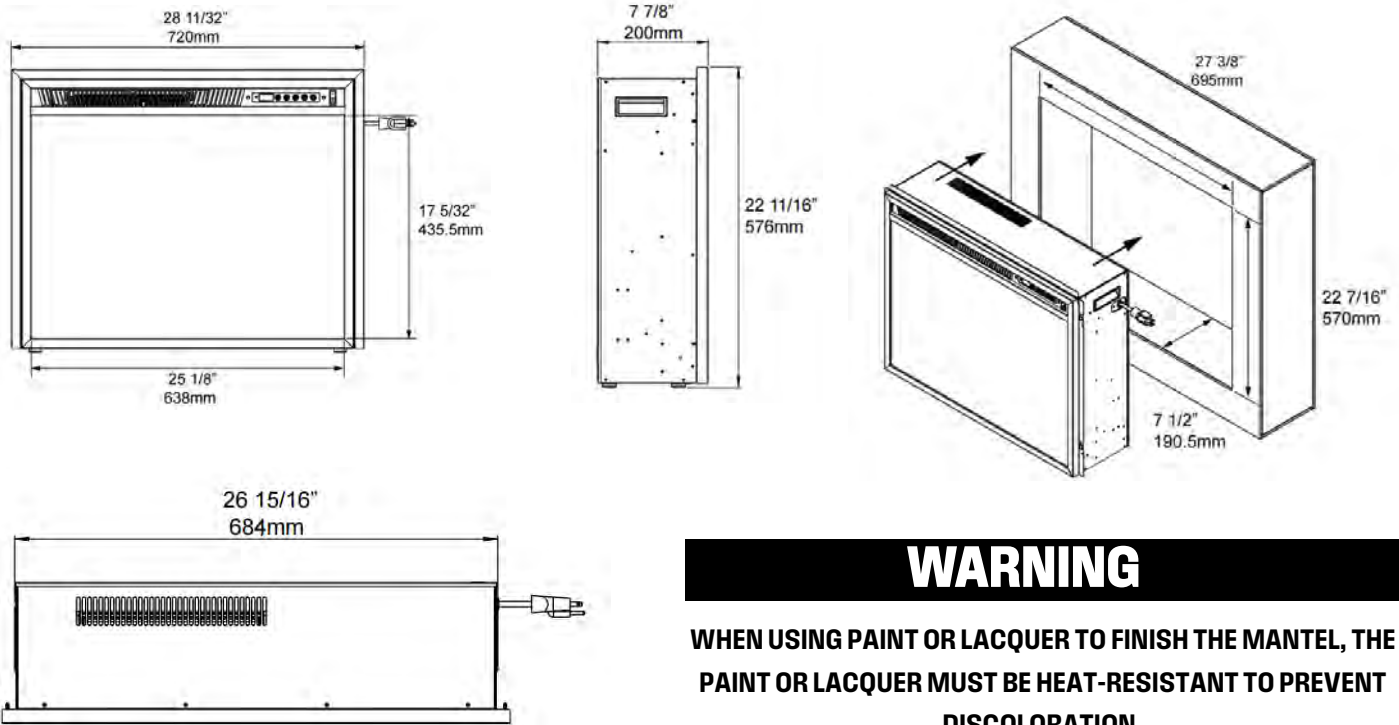

Your appliance is a wall-mounted, recessed and /or mantel installed appliance. Select a suitable location that is not susceptible to moisture and is away from drapes, furniture and high traffic areas. **NOTE: Follow all national and local electrical codes.**

## MINIMUM CLEARANCE TO COMBUSTIBLES

| Measurements are taken from the glass front. |    |     |                          |
|--|----|-----|--------------------------|
| Bottom                                       | 0" | Top | 11.8" (300mm) to mantel  |
| Sides  | 0" | Top | 11.8" (300mm) to ceiling |
| Back   | 0" |     |                          |

# INSTALLATION AND ASSEMBLY

**RECESSED TO WALL INSTALLATION** (Tips: Wall bracket removal is **NOT** required.)

**STEP 1** Select a dry wall to open a hole for fireplace box. **Figure (A)**

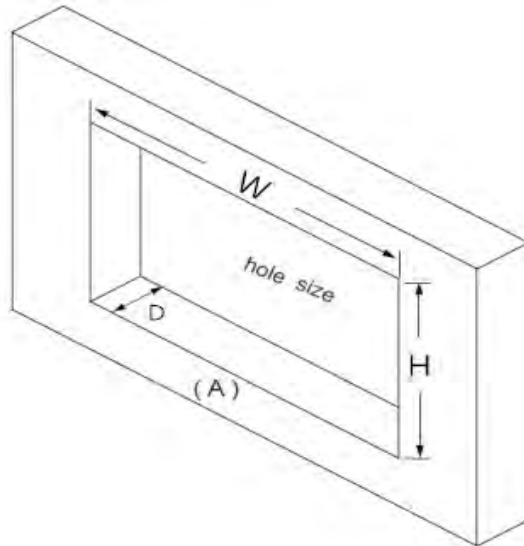

**Figure (A) Hole Cut Size**

| Framing Hole Size |                  |                   |                   |
|-------------------|------------------|-------------------|-------------------|
| Model Number      | W                | H                 | D                 |
| WTH-28EF09A2      | 27 3/8"<br>695mm | 22 7/16"<br>570mm | 7 1/2"<br>190.5mm |

**STEP 2** Lift the decorative kit out upwards, move the fireplace box into the wall hole or fireplace mantel. **Figure (B)**

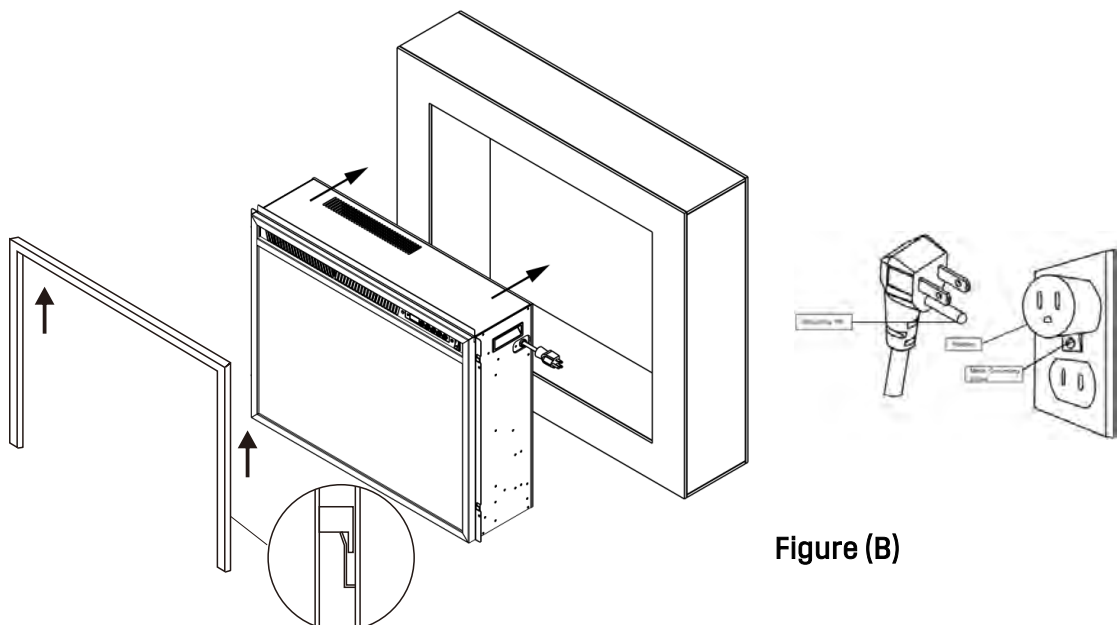

**Figure (B)**

**STEP 3** Use the 4 screws(provided) to lock the appliance into wall or fireplace mantel .**Figure(C)**

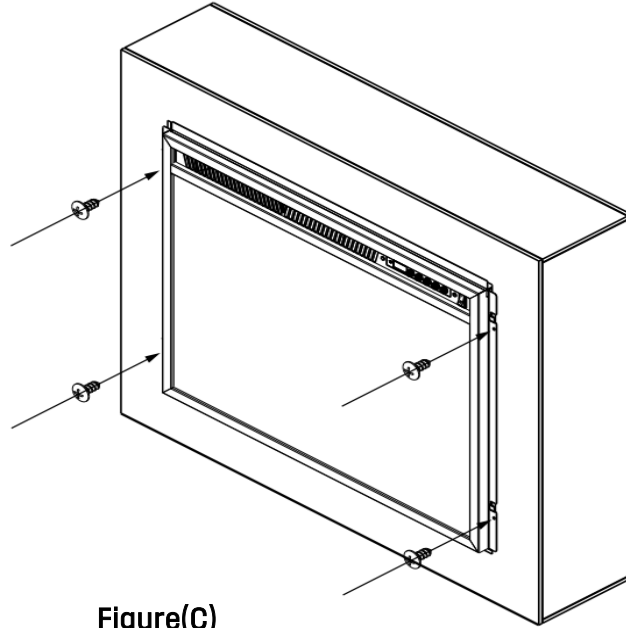

**Figure(C)**

**STEP 4** Fix the trim kit .**Figure(D)**

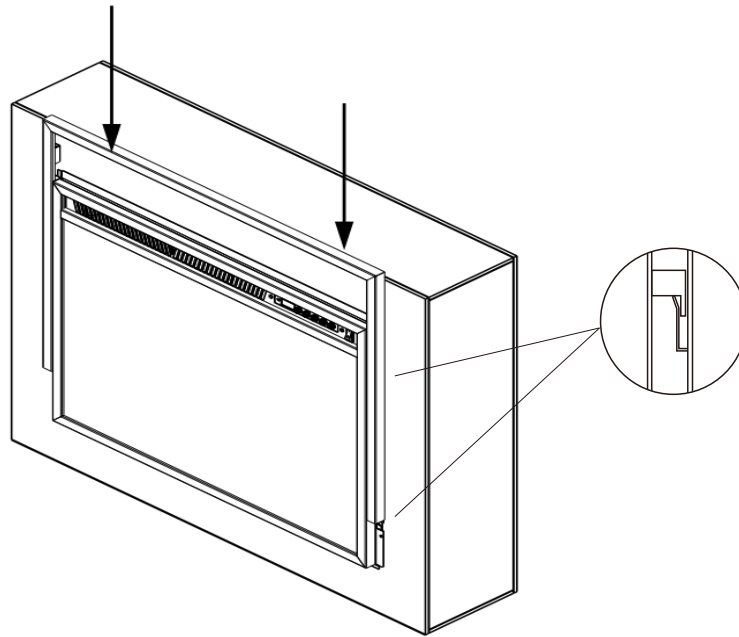

**Figure(D)**



# CONTROL DESCRIPTION

## WARNING



Read and make sure you understand this entire owner's manual, including all safety information, before plugging in or using this product.

Failure to do so could result in electric shock, fire, serious injury, or death.

### POWER

Make sure the ON/OFF switch, located on the control panel, is in the OFF position. Plug the power cord into a 120V 15A grounded outlet (see IMPORTANT SAFETY INFORMATION on pages 2 and 3). Make sure the outlet is in good condition and that the plug is not loose. NEVER exceed the maximum amperage for the circuit. DO NOT plug other appliances into the same circuit.

### METHODS OF OPERATION

This electric fireplace can be operated by the button located on the glass panel at the top right-hand side of the fireplace, or by the battery-powered REMOTE CONTROL.

The operation and functions of the two methods are the same.

Before operating, please review the IMPORTANT SAFETY INFORMATION on pages 2 and 3, and heed all warnings.

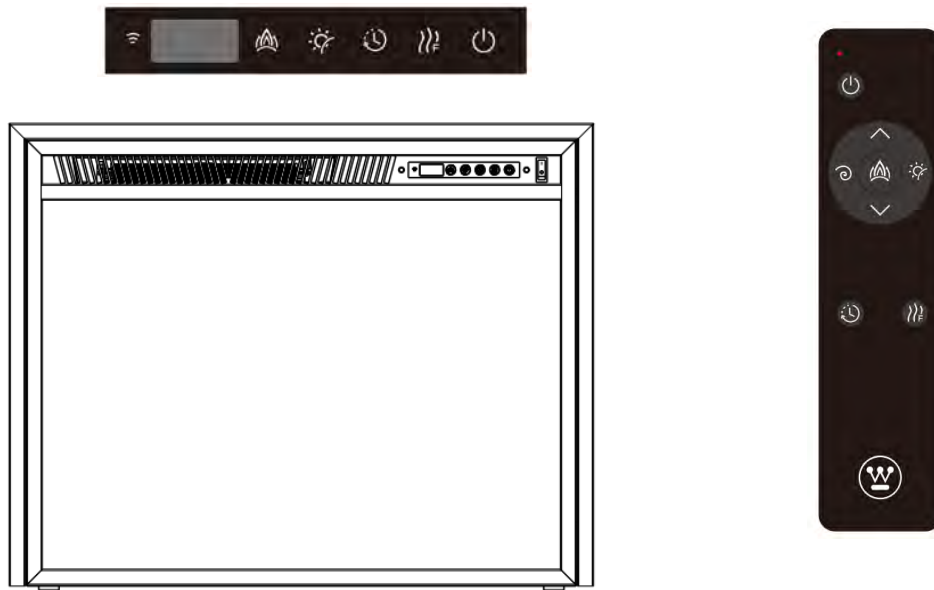

Power standby switch

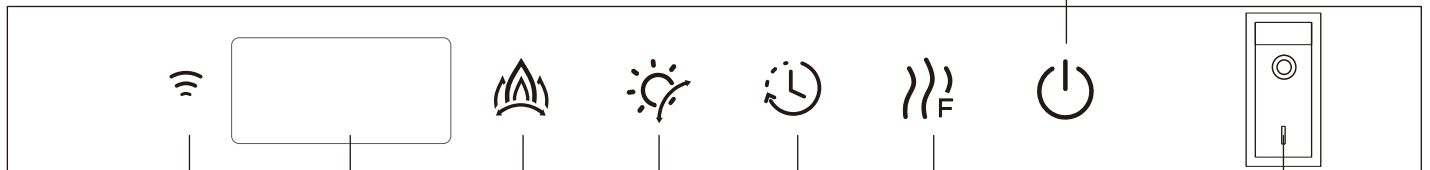

WIFI

DISPLAY AREA

FLAME

EMBER

TIMER









HEATER

MAIN POWER SWITCH

color / brightness



Turn on main power switch first.

| BUTTON   | FUNCTION  | ACTIONS INDICATION   |
|--|---|--|
| <br>POWER   | ON: Enables control panel functions and remote control. Turns on flame effect.<br>OFF: Disables control panel functions and remote control. Turns off flame effect.   | 1. Press once. Indicator light turns on. Power turns on. All functions enabled.<br>2. Press again. Indicator light turns off. Power turns off. All functions turn off.   |
| <br>HEATER  | HEATER button: Turns heater on and off.<br>NOTE: To prevent overheating, the heater fan will blow out cool air for 30 seconds after the heater turns off. TEMPERATURE button: Controls temperature settings to choose desired temperature.<br>Settings range from 62°F to 82°F. | 1. Press once. Indicator lights up (LOF). 750W heater turns on and blows out warm air.<br>2. Press again. Indicator lights up (HIF). 1500W heater turns on and blows hot air.<br>3. Press again. Smart 72°F.<br>4. Press again. Heaters turn off. The display shows "OFF".<br>5. Hold button for 3 seconds to start temperature control mode. The temperature can be set to between 62°F and 82°F. |
| <br>TIMER   | TIMER button: Controls timer settings to turn off fireplace at selected time.<br>Settings range from 0 hours to 24 hours.   | 1. Press once. Indicator light turns on.<br>2. Press again until desired setting is reached (0-8 h). LED display shows setting.<br>3. Hold button for 3 seconds to set between 0 and 24 hours.   |
| <br>EMBER | EMBER button:<br>Makes the ember bed color effect change. Makes the ember bed effect dimmer and brighter.   | 1. Press once. Ember bed color effect changes (12 colors).<br>2. Press again until desired setting is reached. When color is set to C0, the ember bed color will automatic change.<br>3. Hold button for 3 seconds to make the ember bed effect dimmer and brighter (L5-L1).   |
| <br>FLAME | FLAME button:<br>Makes the flame color effect change. Makes the flame effect dimmer and brighter.   | 1. Press once. Flame color effect changes (12 colors).<br>2. Press again until desired setting is reached. When color is set to F0, the flame color will automatically change.<br>3. Hold button for 3 seconds to make the flame effect dimmer and brighter (L5-L1).   |
| <br>UP    | UP button: Flame & ember bed color/Dimmer and brighter/Timer/Flame speed/Temperature  | Flame & ember bed color/Dimmer and brighter/Timer/Flame speed/Temperature.   |
| <br>DOWN  | DOWN button: Flame & ember bed color/Dimmer and brighter/Timer/Flame speed/Temperature  | Flame & ember bed color/Dimmer and brighter/Timer/Flame speed/Temperature.   |
| <br>SPEED | FLAME SPEED button: Sets the flame speed (S5-S1).   | Sets the flame speed (S5-S1).  |

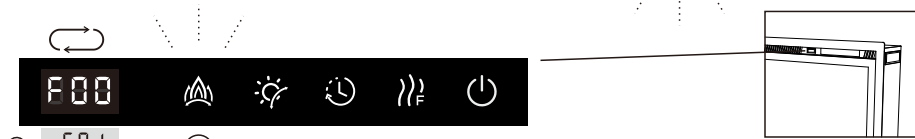
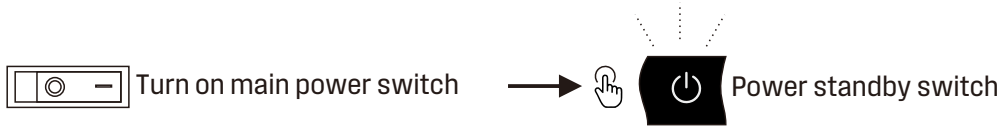

Flame color effect

Press for 3s. Then press the flame brightness effect button.

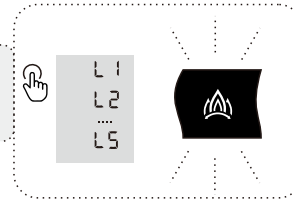

Ember bed color effect

3s Press for 3s. Then press the ember bed brightness effect button.

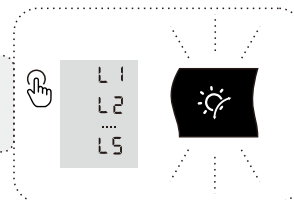

Timer to turn off the fireplace



Heater 750W /1500W/ 72F/OFF

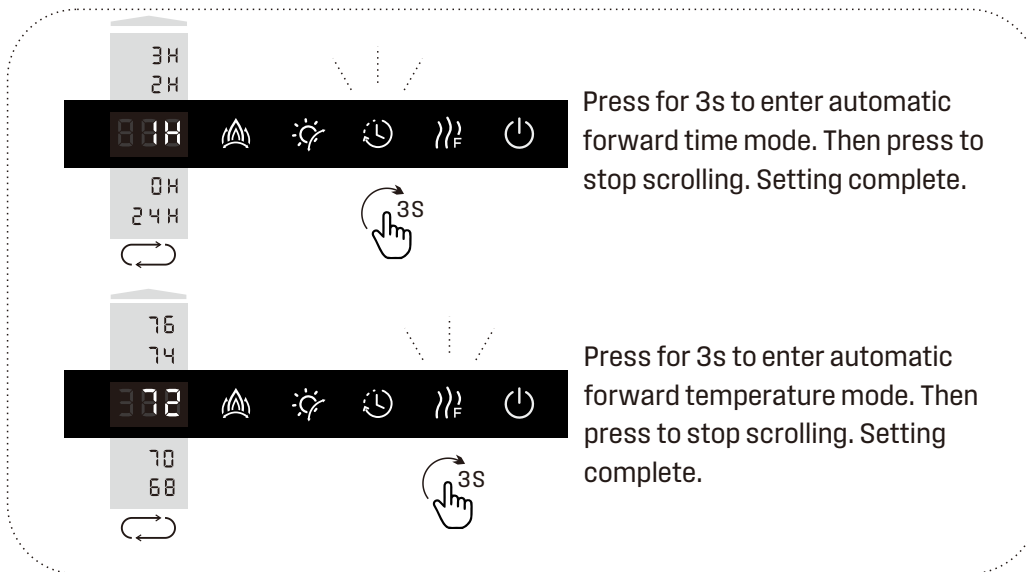

# Remote Control Description

## REMOTE

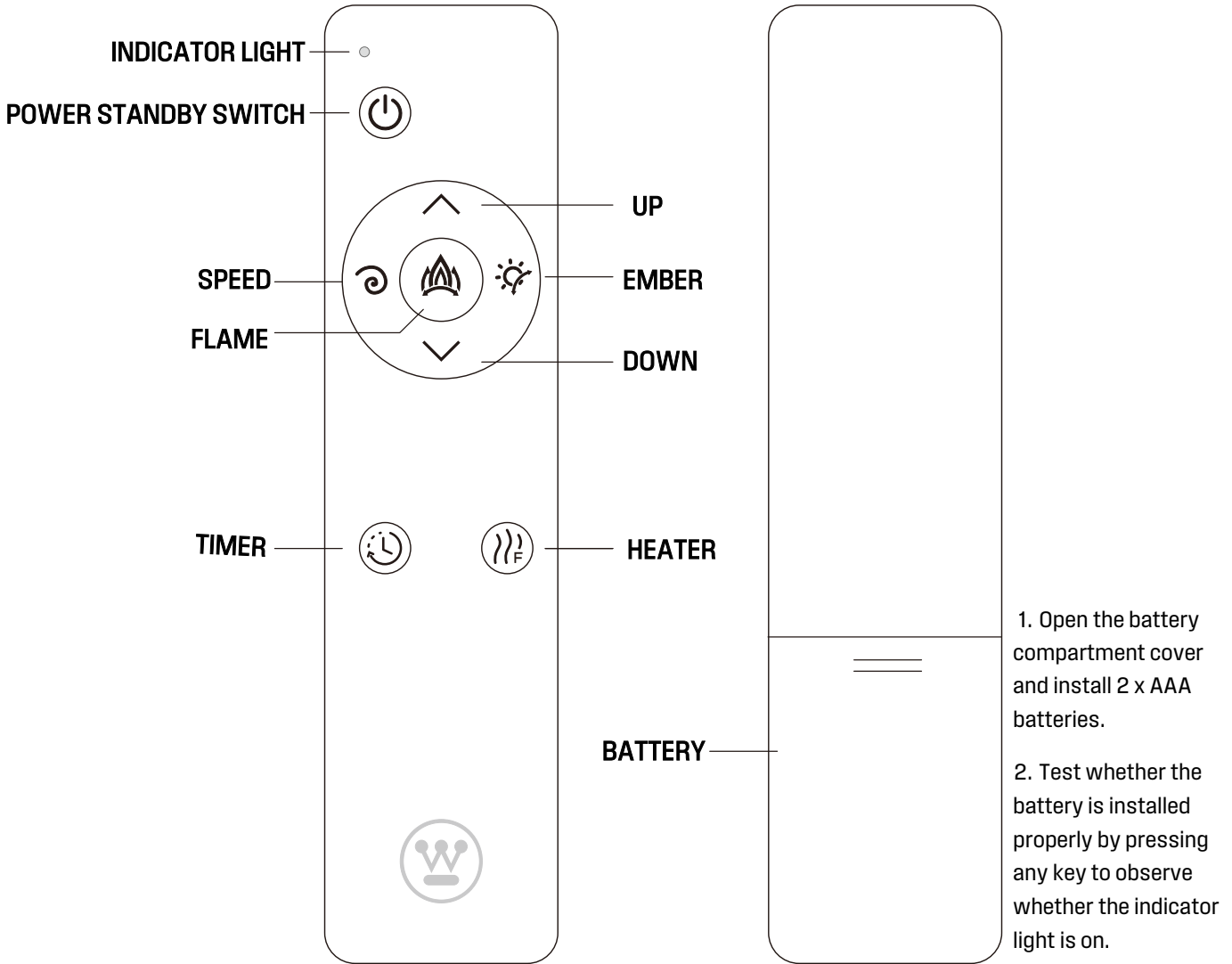

### MODE 1

Remote control  
1. Illustration of button mode.



### MODE 2

Remote control  
2. Remote control function selection mode - up and down selection.



# NOTICE

To improve operation, aim the remote control at the front of the fireplace. DO NOT press the buttons too quickly. Give the unit time to respond to each command.

- Excludes batteries. Prepare 2 x AAA batteries.

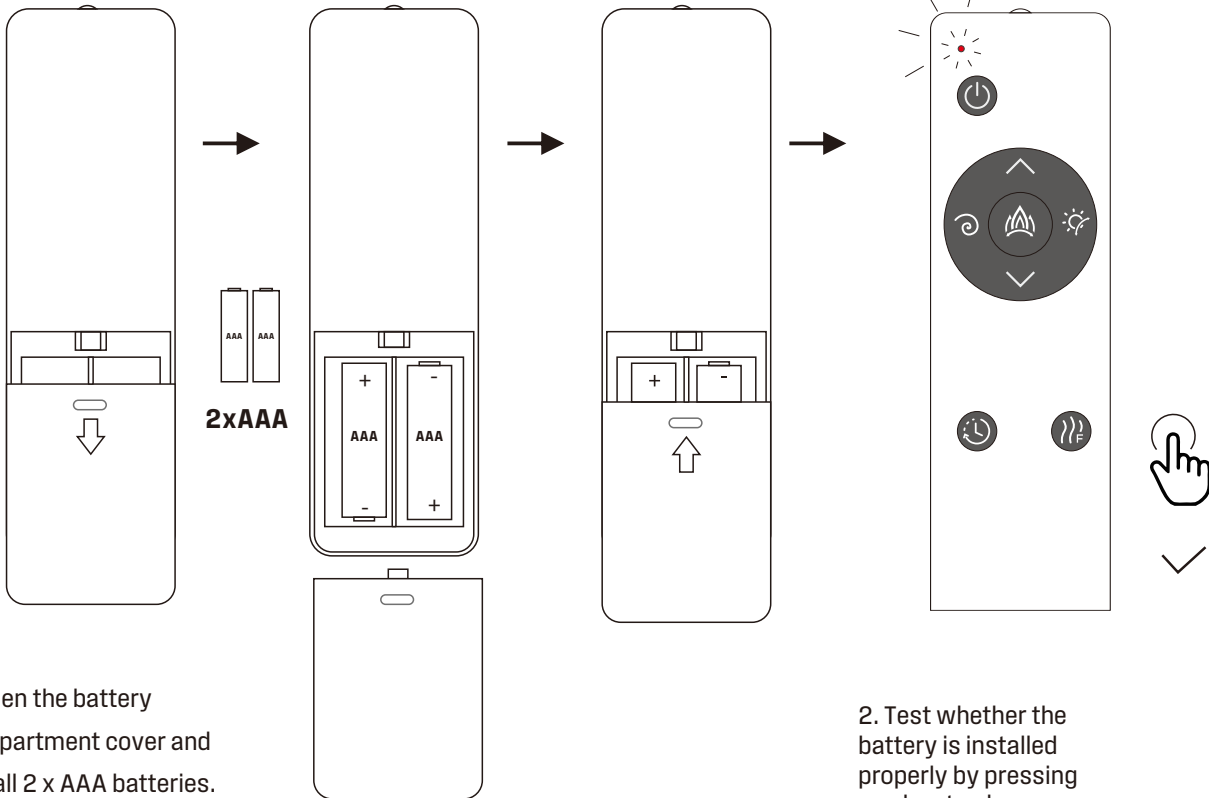

1. Open the battery compartment cover and install 2 x AAA batteries.

2. Test whether the battery is installed properly by pressing any key to observe whether the indicator light is on.

- Remote control to adjust brightness.

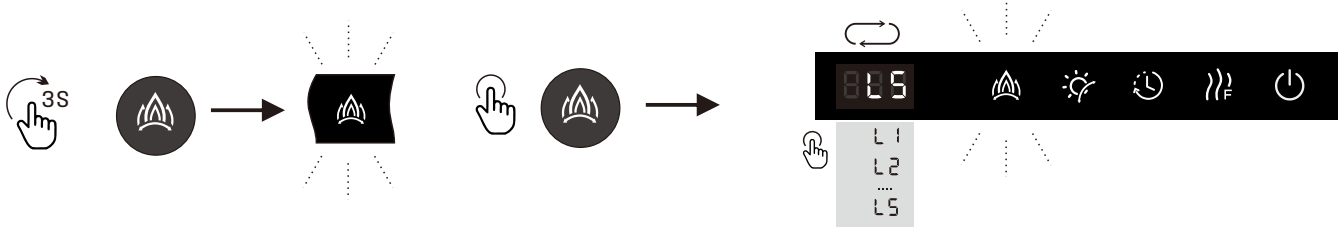

Press for 3s. Then press the flame brightness effect button..

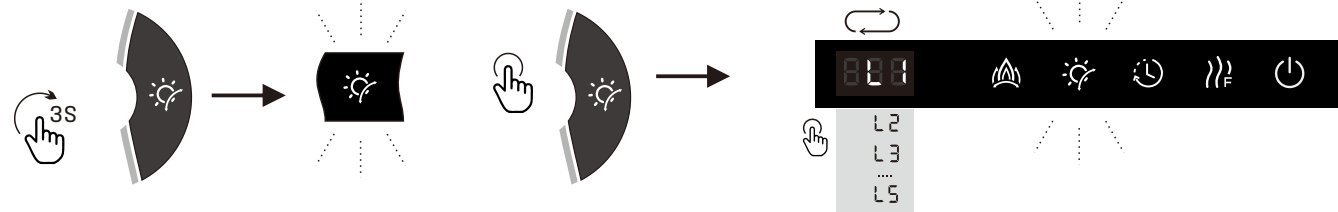

Press for 3s. Then press the ember bed brightness effect button..

# Remote control 1. Illustration of button mode

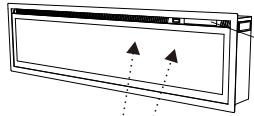

15chi

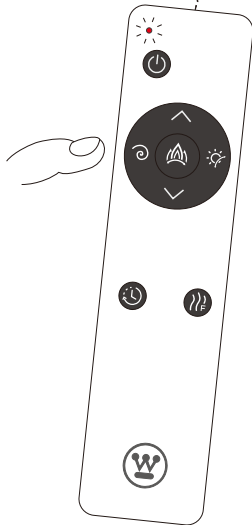

Press any key to remotely activate the control board. Once the control board lights up, control operations can be carried out.

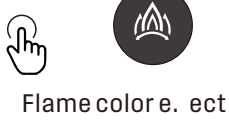

Flame color e. ect

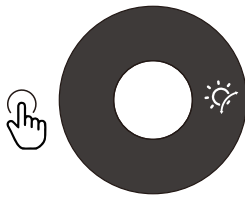

Ember bed color e. ect

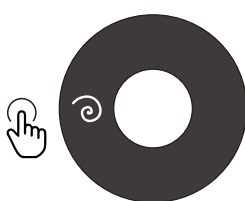
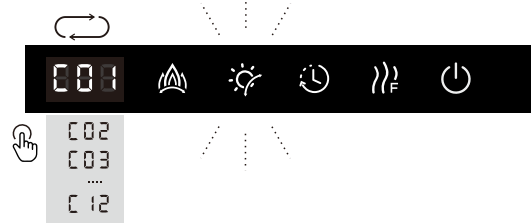

Setting the flame speed



Timer to turn off the fireplace



UP/DOWN to select a temperature

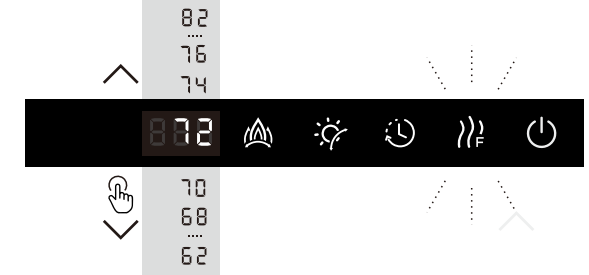

Heater 750W/1500W/72F/OFF



## Remote control 2. Remote control function selection mode - up and down selection

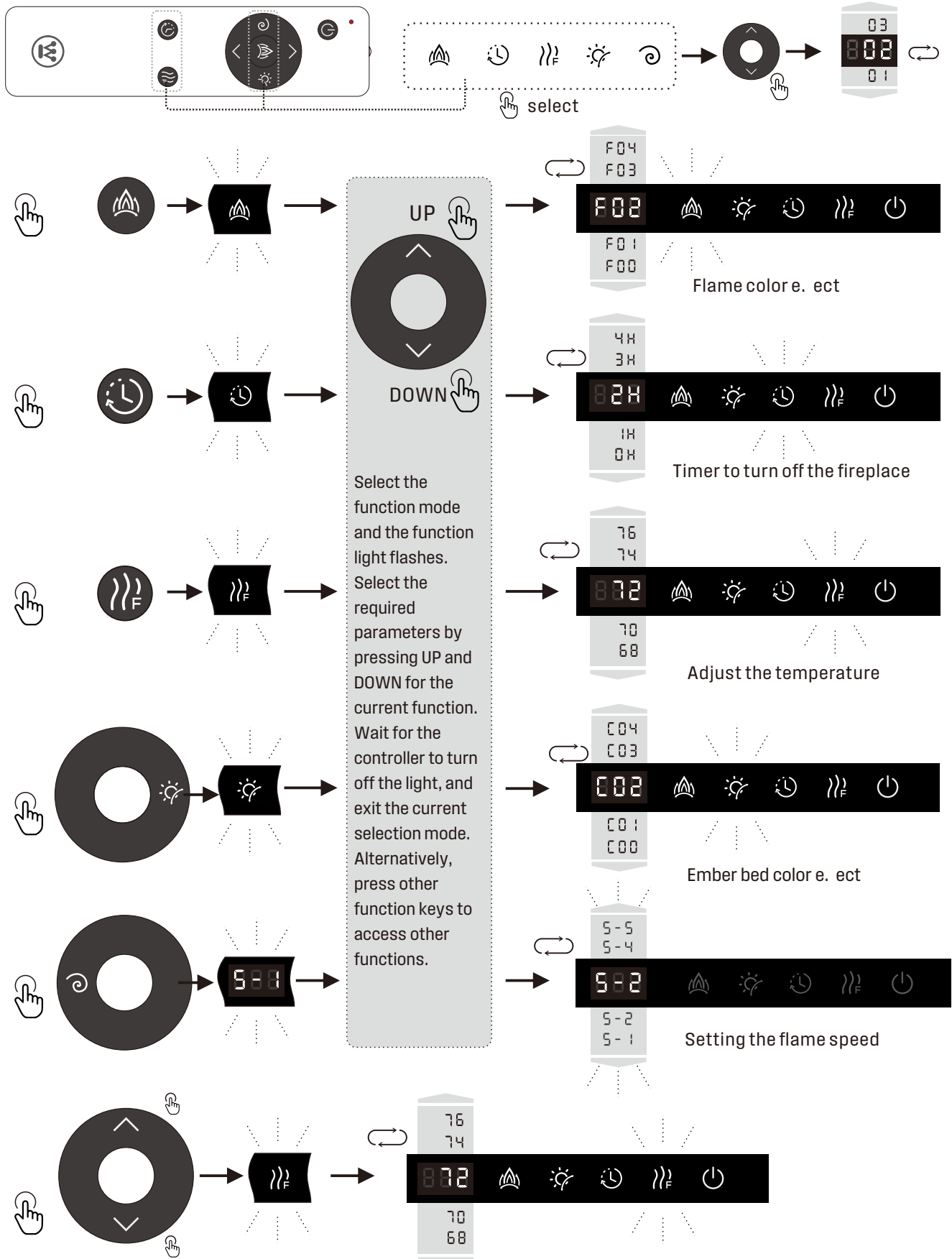

The default mode up and down keys can directly adjust the temperature.

# WI-FI LINK CONTROL

## Fireplace networking process

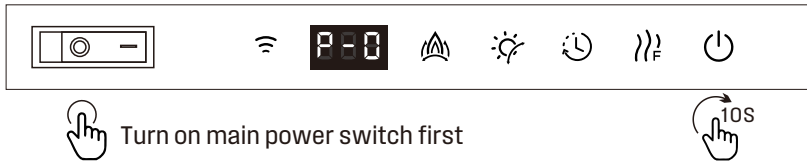

Press the power standby button  for 10s to enter the network distribution mode. The WI-FI indicator flashes, showing "P-0".

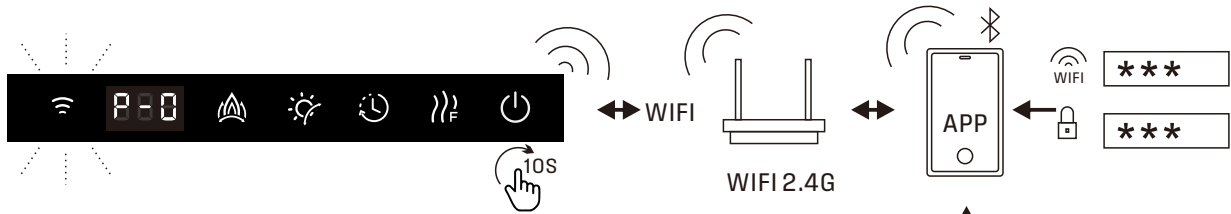

The WIFI indicator light in distribution mode flashes, displaying "P-0" Add WIFI network and mobile app for network distribution. Turn on Bluetooth and WIFI



**Android App Store**



**Apple App Store**

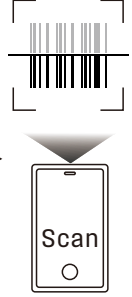

Scan

**or**

Google Play and App Store for Android and IOS Search "Westinghouse" and install the app



Westinghouse

Scan code with cell phone to install "Westinghouse" app

Install the "Westinghouse" app

### Registration process

1. Open the "Westinghouse" app, click register, and start registration
  2. Enter your email address and fill in the verification code
  3. Set your login password
  4. Enter the app to open the settings page, then allow nearby devices and location
- NOTE: You should allow the app access "Location" and "Nearby devices" on your cell phone before networking.



Note: Please make sure that the wireless network and the Bluetooth function of the cell phone are turned on before networking. Open the app to go to the home page, click add device and the app will automatically search for the fireplace. Press add fireplace (or scan app code).

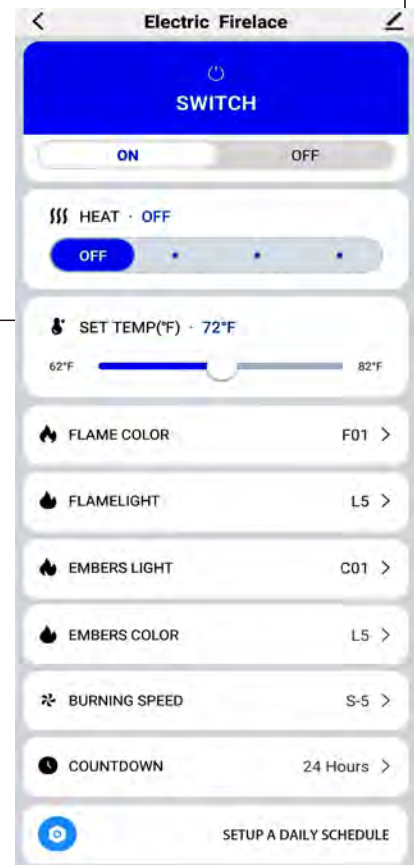

### WiFi connectivity

802.11 B/G/N20  
 Channel 1-14 @ 2.4GHz  
 Supports Bluetooth 4.2 Low Energy  
 Support WPA/WPA2 security mode  
 Output power of +20dBm in 802.11b mode  
 Support for SmartConfig functionality (including Android and IOS devices)  
 Onboard PCB Onboard antenna  
 Working temperature: -4°F to 185°F





# Alexa Link and Voice Control

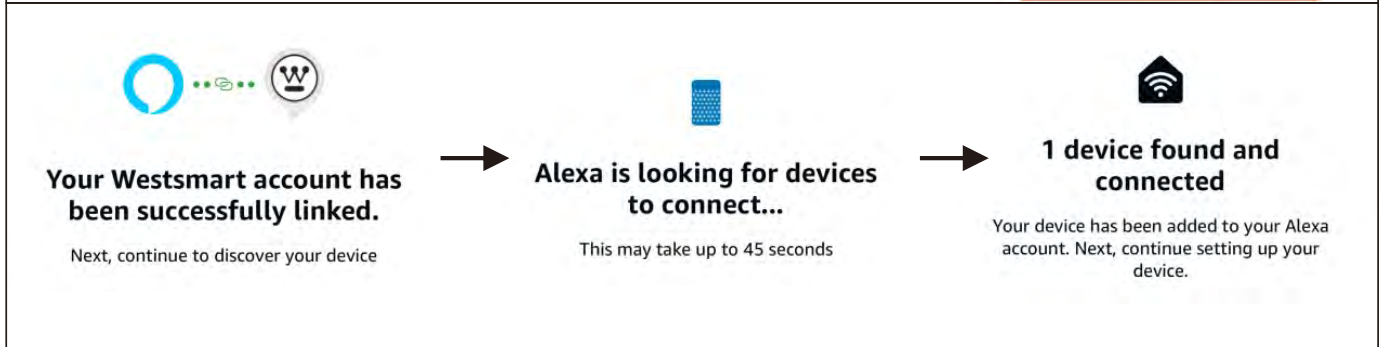
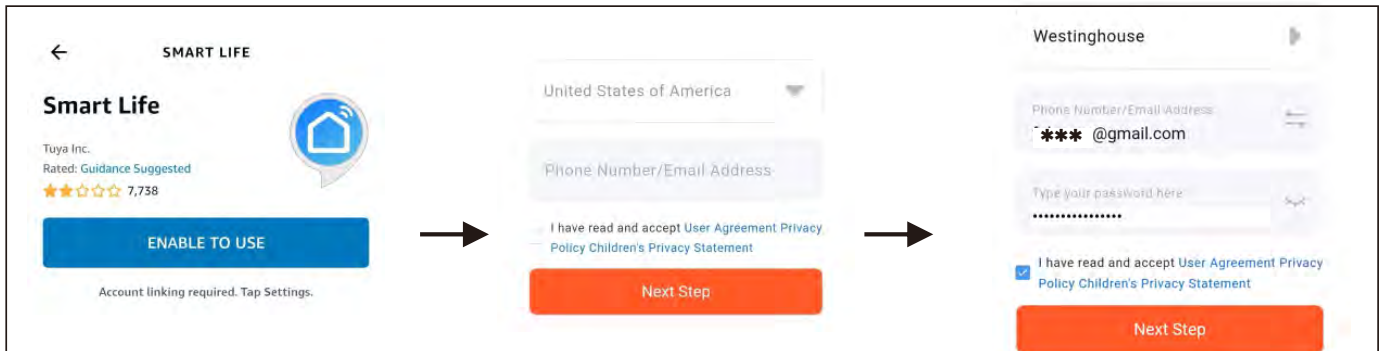
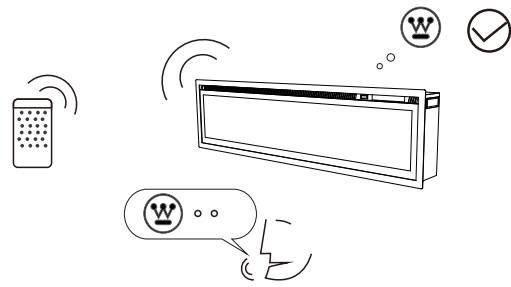
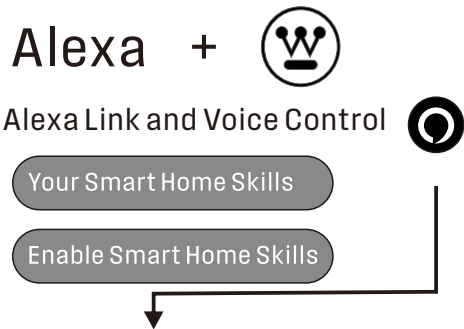



**heater is set up and ready to use**

To control it, say  
"Alexa, turn off heater"

1. Your Smart Home Skills
2. Enable Smart Home Skills to discover devices and scenes that Alexa can control.
3.  Search for "Smart Life".
4. ENABLE "Smart Life" TO USE.
5. Associated "Westinghouse" account.
6. Alexa is looking for devices to connect to.
7. Device found and connected.
8. Heater is set up and ready to use.

Special statement: The content of this material has been carefully checked. If there are typographical errors and omissions in the content of this manual, in case of misunderstanding, the company reserves the right of final interpretation.

\* If the product is technically improved without notice, or the appearance and color of the product are changed, the actual product shall prevail.

## **For Both FCC & IC application:**

This device complies with Part 15 of the FCC Rules / Industry Canada licence-exempt

RSS standard(s). Operation is subject to the following two conditions: (1) this device may not cause harmful interference, and (2) this device must accept any interference received, including interference that may cause undesired operation.

Le présent appareil est conforme aux CNR d'Industrie Canada applicables aux appareils radio exempts de licence. L'exploitation est autorisée aux deux conditions suivantes : (1) l'appareil ne doit pas produire de brouillage, et (2) l'utilisateur de l'appareil doit accepter tout brouillage radioélectrique subi, même si le brouillage est susceptible d'en compromettre le fonctionnement.

Changes or modifications not expressly approved by the party responsible for compliance could void the user's authority to operate the equipment.

This equipment has been tested and found to comply with the limits for a Class B digital device, pursuant to part 15 of the FCC Rules. These limits are designed to provide reasonable protection against harmful interference in a residential installation. This equipment generates uses and can radiate radio frequency energy and, if not installed and used in accordance with the instructions, may cause harmful interference to radio communications. However, there is no guarantee that interference will not occur in a particular installation. If this equipment does cause harmful interference to radio or television reception, which can be determined by turning the equipment off and on, the user is encouraged to try to correct the interference by one or more of the following measures:

- Reorient or relocate the receiving antenna.
- Increase the separation between the equipment and receiver.
- Connect the equipment into an outlet on a circuit different from that to which the receiver is connected.
- Consult the dealer or an experienced radio/TV technician for help.

## **MPE Requirements**

To satisfy FCC / IC RF exposure requirements, a separation distance of 20 cm or more should be maintained between the antenna of this device and persons during device operation.

To ensure compliance, operations at closer than this distance is not recommended.

Les antennes installées doivent être situées de façon à ce que la population ne puisse y être exposée à une distance de moins de 20 cm. Installer les antennes de façon à ce que le personnel ne puisse approcher à 20 cm ou moins de la position centrale de l'antenne.

La FCC des états-unis stipule que cet appareil doit être en tout temps éloigné d'au moins 20 cm des personnes pendant son fonctionnement.

## **WARNING**

This product can expose you to chemicals including [name of one or more chemicals known to cause cancer, name of one or more chemicals known to cause reproductive toxicity, or name of one or more chemicals known to cause both cancer and birth defects or other reproductive harm], which is [are] known to the State of California to cause cancer or birth defects or other reproductive harm. For more information go to [www.P65Warnings.ca.gov/furniture](http://www.P65Warnings.ca.gov/furniture).

## **NOTICE 1**

When the heater is first turned on, a slight odor may be present. This is normal and should not occur again unless the heater is not used for a long period of time.

## **NOTICE 2**

To improve operation, aim the remote control at the front of the fireplace. **DO NOT** press the buttons too quickly. Give the unit time to respond to each command.

### **Temperature Limiting Control**

This heater is equipped with a Temperature Limiting Control. Should the heater reach an unsafe temperature, the heater will automatically turn OFF. To reset:

1. Unplug the power cord from the outlet.
2. Turn the ON/OFF switch on the CONTROL PANEL to OFF. Wait for 5- minutes.
3. Inspect the fireplace to make sure no vents are blocked, or clogged with dust or lint. If there are, use a vacuum to clean the vent areas.
4. With the POWER switch in the OFF position, plug the power cord back into the outlet.
5. If the problem continues, have your outlet and wiring inspected by a professional.

### **Remote Control Battery Information**

- Excludes batteries. Prepare 2 x AAA batteries.



**NEVER** dispose of batteries in a fire. Failure to observe this precaution may result in an explosion.

Dispose of batteries at your local hazardous material processing center.

## **CARE AND MAINTENANCE**

### **Cleaning**



**ALWAYS** turn the heater **OFF** and **unplug the power cord from the outlet** before cleaning, performing maintenance, or moving this fireplace. Failure to do so could result in **electric shock, fire, or personal injury.**



**NEVER** immerse in water or spray with water. Doing so could result in **electric shock, fire, or personal injury.**

### **Metal:**

- Buff using a soft cloth, slightly dampened with a citrus oil-based product.
- **DO NOT** use brass polish or household cleaners as these products will damage the metal trim.

### **Glass:**

- Use a good quality glass cleaner and dry thoroughly with a paper towel or lint-free cloth.
- **NEVER** use abrasive cleansers, liquid sprays, or any cleaner that could scratch the surface.

## Vents:

- Use a vacuum or duster to remove dust and dirt from the heater and vent areas.
- Clean the exterior of the fireplace with a slightly damp cloth or duster.

## Maintenance



**Risk of electric shock! DO NOT OPEN! No user-serviceable parts inside!**



**ALWAYS** turn the heater **OFF** and **unplug the power cord from the outlet** before cleaning, performing maintenance, or moving this fireplace. Failure to do so could result in **electric shock, fire, or personal injury.**

## Electrical and Moving Parts:

- The fan motors are lubricated at the factory and will not require lubrication.
- Electrical components are integrated in the fireplace and are not serviceable by the consumer.

## Storage:

- Store heater in a clean dry place when not in use.



**WARNING!** No other servicing should be performed by the consumer. Do not attempt to service the unit yourself.

## *Troubleshooting*

# **WARNING**

DISCONNECTED THE APPLIANCE COMPLETELY AND LET COOL PRIOR TO ANY SERVICE.  
ONLY PROFESSIONAL TECHNICIANS CAN REPAIR THIS APPLIANCE .

| PROBLEM                                   | POSSIBLE CAUSE  | SOLUTION   |
|---|---|--|
| Fireplace turns off and will not turn on. | 1. Fireplace has overheated and safety device has caused thermal switch to disconnect or home circuit breaker has opened. | 1. Reset switch by turning the main power switch off and waiting to turn it back on.   |
| Flame is not moving.                      | 1. Loose wiring.<br>2. Flame motor defective.<br>3. Flame rod out of place.   | 1. Inspect wiring for loose connections.<br>2. Call a qualified service technician to replace flame motor.<br>3. "Flame Rod" out of place due to rough transit/handling of the product. This issue can be corrected by simply removing the glass, flipping the fireplace upside down, removing the set of screws that are holding the bottom frame plate, and placing the flame rod back into place. |

|                               |  |  |
|-------------------------------|--|--|
| Flame is not visible.         | 1. Wiring is loose.  | <ol style="list-style-type: none"> <li>1. Disconnect from power source and inspect wiring for loose connections and repair or replace if necessary.</li> <li>2. Push the flame button to high.</li> </ol>  |
| Log set is not glowing.       | <ol style="list-style-type: none"> <li>1. Wiring is loose.</li> <li>2. Ember mode is off.</li> </ol>   | 1. Disconnect from power source and inspect wiring for loose connections and repair or replace if necessary.   |
| Remote control does not work. | <ol style="list-style-type: none"> <li>1. Low batteries.</li> <li>2. Not aiming remote control correctly.</li> <li>3. Defective remote control and/or sensor.</li> </ol> | <ol style="list-style-type: none"> <li>1. Replace batteries in remote control.</li> <li>2. Aim remote control at sensor located directly behind glass screen in center of unit just above logs.</li> <li>3. Replace remote control and/or sensor.</li> </ol> |

## ELECTRICAL SCHEMATIC

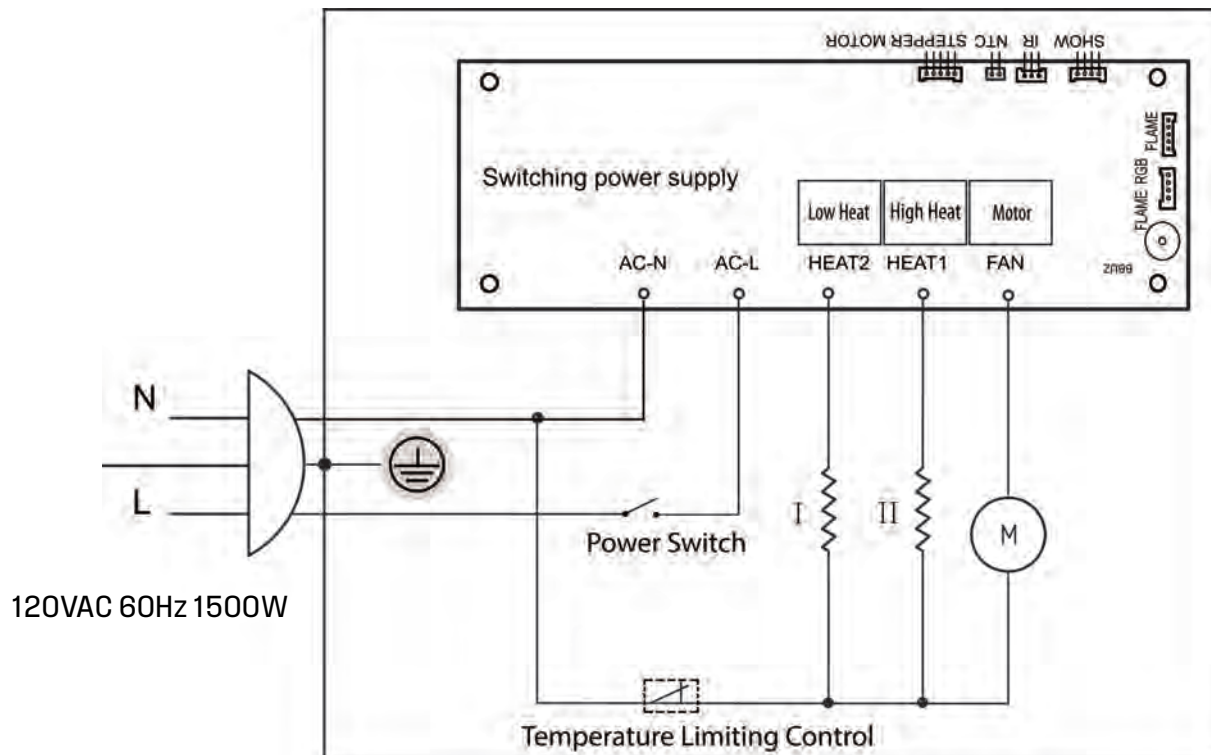

# CUSTOMER SUPPORT

## Returns

The returns policy refers to products purchased directly from Westinghouse Fireplace. Reseller sales are subject to the respective policies of the seller.

## Electric Fireplace Returns Policies

- If an order arrives damaged, defective, or incomplete, please contact.

**[fireplace@efp.westinghouse.com](mailto:fireplace@efp.westinghouse.com)**

- If a product is discovered to be damaged or defective after fourteen (14) days of delivery, the product will be processed under its warranty.
- Westinghouse Fireplace does not accept returns for refunds due to customer change of mind more than thirty (30) days after delivery.
- Fireplaces may be returned due to customer change of mind in the original packaging and in saleable condition within thirty (30) days from the date of delivery.
- Product return warranty coverage does not include man-made damage to the product.
- Return shipping costs are the responsibility of the consumer.

## Warranty

- 2-year warranty (2-year full replacement) .
- Replacement of any non-functioning electronic parts.

**CONTACT US : [fireplace@efp.westinghouse.com](mailto:fireplace@efp.westinghouse.com)**