

SAMPLE SAMPLE SAMPLE

1. SELECT MAIN EDGE PROFILE

Page 1 of 1

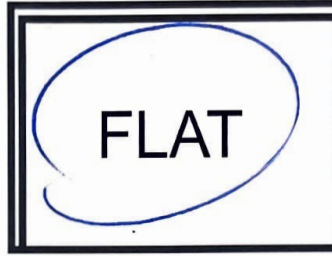

2. ENTER COLOR INFORMATION

3. KEY

ⓕ = flat laminated

Ⓢ = unfinished

ⓐ = splash

ⓑ = profiled edge

ⓓ = radius (only on flat edges)

1 3460-11

QTY Color / Pattern No. - Finish / Texture (ex: 1573-60)

CALACATTA MARBLE

Color / Pattern Name (ex: Frosty White)

4. ENTER DIMENSIONS AND EDGE INFO (from # 3 key above)

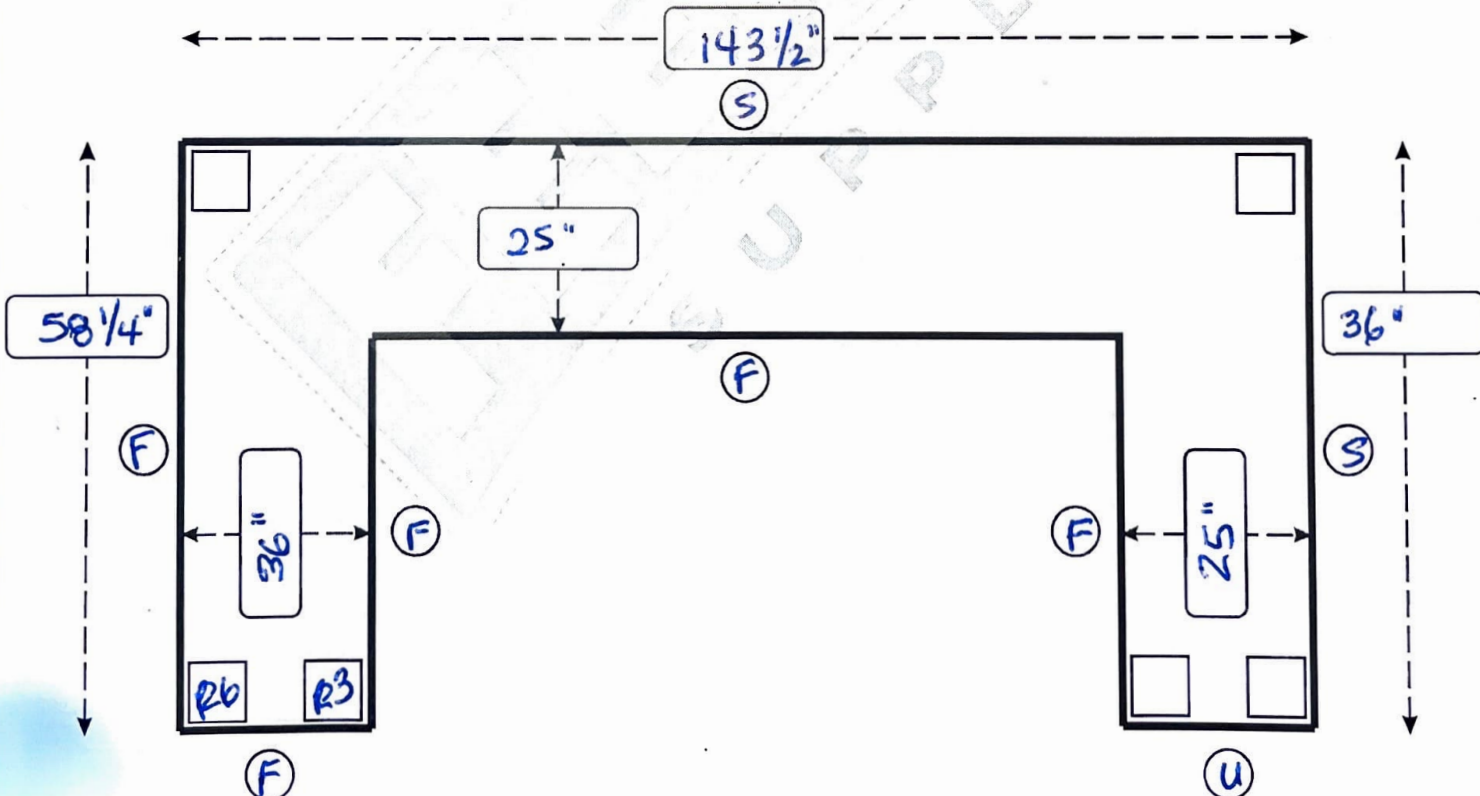

*** Countertops will be shipped unassembled at joints. All assembly hardware will be included.

SAMPLE SAMPLE SAMPLE

1. SELECT MAIN EDGE PROFILE

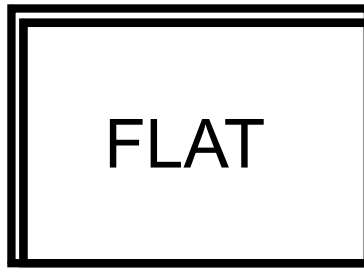
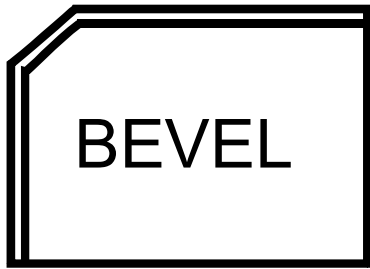

2. ENTER COLOR INFORMATION

QTY Color / Pattern No. - Finish / Texture (ex: 1573-60)

Color / Pattern Name (ex: Frosty White)

3. KEY

- ⓕ = flat laminated
- Ⓢ = unfinished
- Ⓣ = splash
- Ⓟ = profiled edge
- Ⓡ = radius (only on flat edges)

4. ENTER DIMENSIONS AND EDGE INFO (from # 3 above)

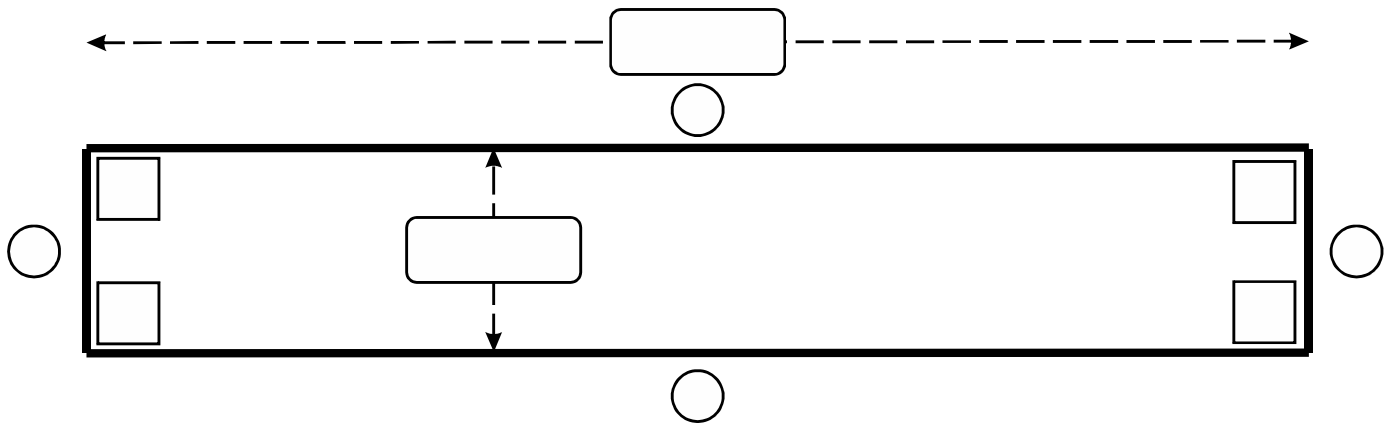

*** Countertops will be shipped unassembled at joints. All assembly hardware will be included.

1. SELECT MAIN EDGE PROFILE

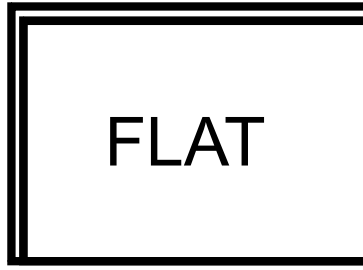
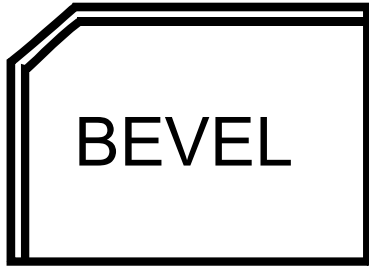

2. ENTER COLOR INFORMATION

QTY Color / Pattern No. - Finish / Texture (ex: 1573-60)

Color / Pattern Name (ex: Frosty White)

3. KEY

- ⓕ = flat laminated
- Ⓢ = unfinished
- Ⓞ = splash
- Ⓟ = profiled edge
- Ⓡ = radius (only on flat edges)

4. ENTER DIMENSIONS AND EDGE INFO (from # 3 key above)

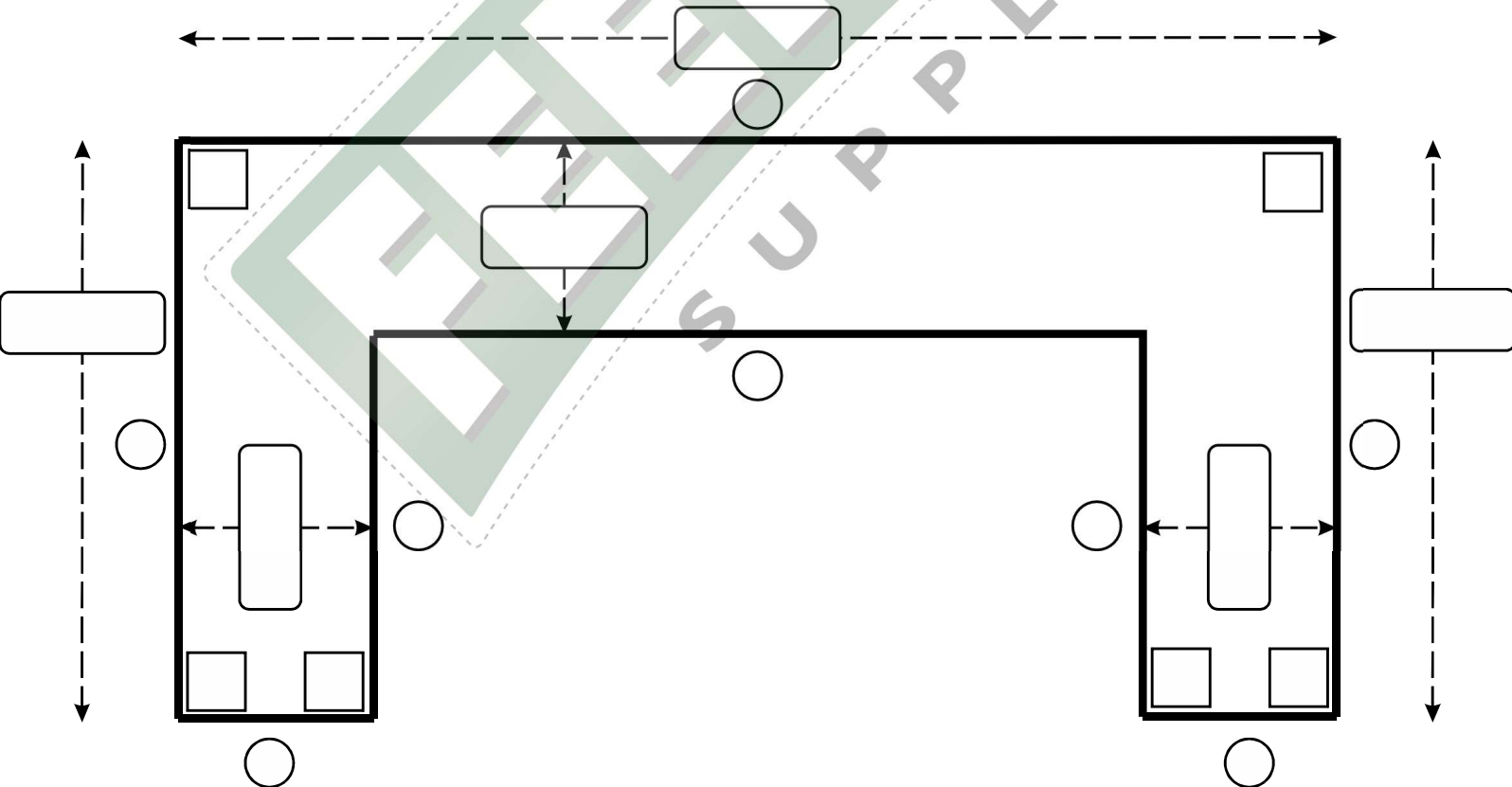

*** Countertops will be shipped unassembled at joints. All assembly hardware will be included.

1. SELECT MAIN EDGE PROFILE

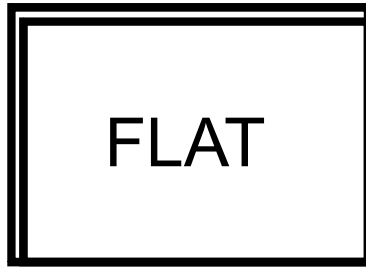
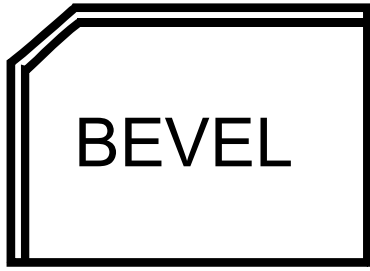

2. ENTER COLOR INFORMATION

QTY Color / Pattern No. - Finish / Texture (ex: 1573-60)

Color / Pattern Name (ex: Frosty White)

3. KEY

- ⓕ = flat laminated
- Ⓢ = unfinished
- Ⓣ = splash
- Ⓟ = profiled edge
- Ⓡ = radius (only on flat edges)

4. ENTER DIMENSIONS AND EDGE INFO (from # 3 key above)

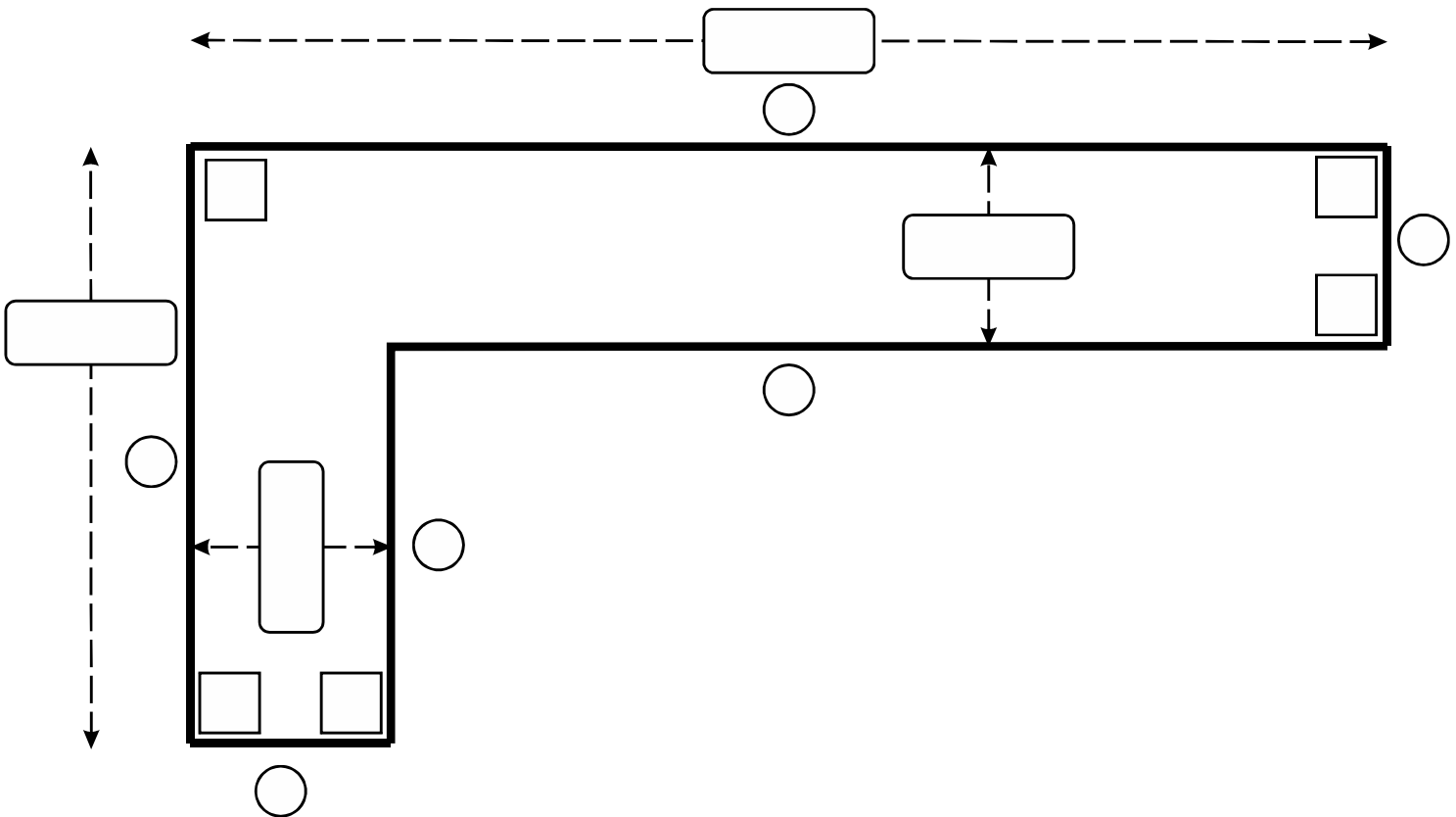

*** Countertops will be shipped unassembled at joints. All assembly hardware will be included.

1. SELECT MAIN EDGE PROFILE

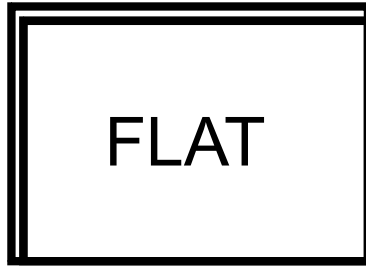
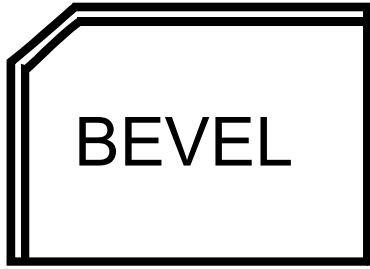

2. ENTER COLOR INFORMATION

<input type="text"/>	<input type="text"/>
----------------------	----------------------

QTY Color / Pattern No. - Finish / Texture (ex: 1573-60)

<input type="text"/>

Color / Pattern Name (ex: Frosty White)

3. KEY

- ⓕ = flat laminated
- Ⓢ = unfinished
- Ⓣ = splash
- Ⓟ = profiled edge
- Ⓡ = radius (only on flat edges)

4. ENTER DIMENSIONS AND EDGE INFO (from # 3 key above)

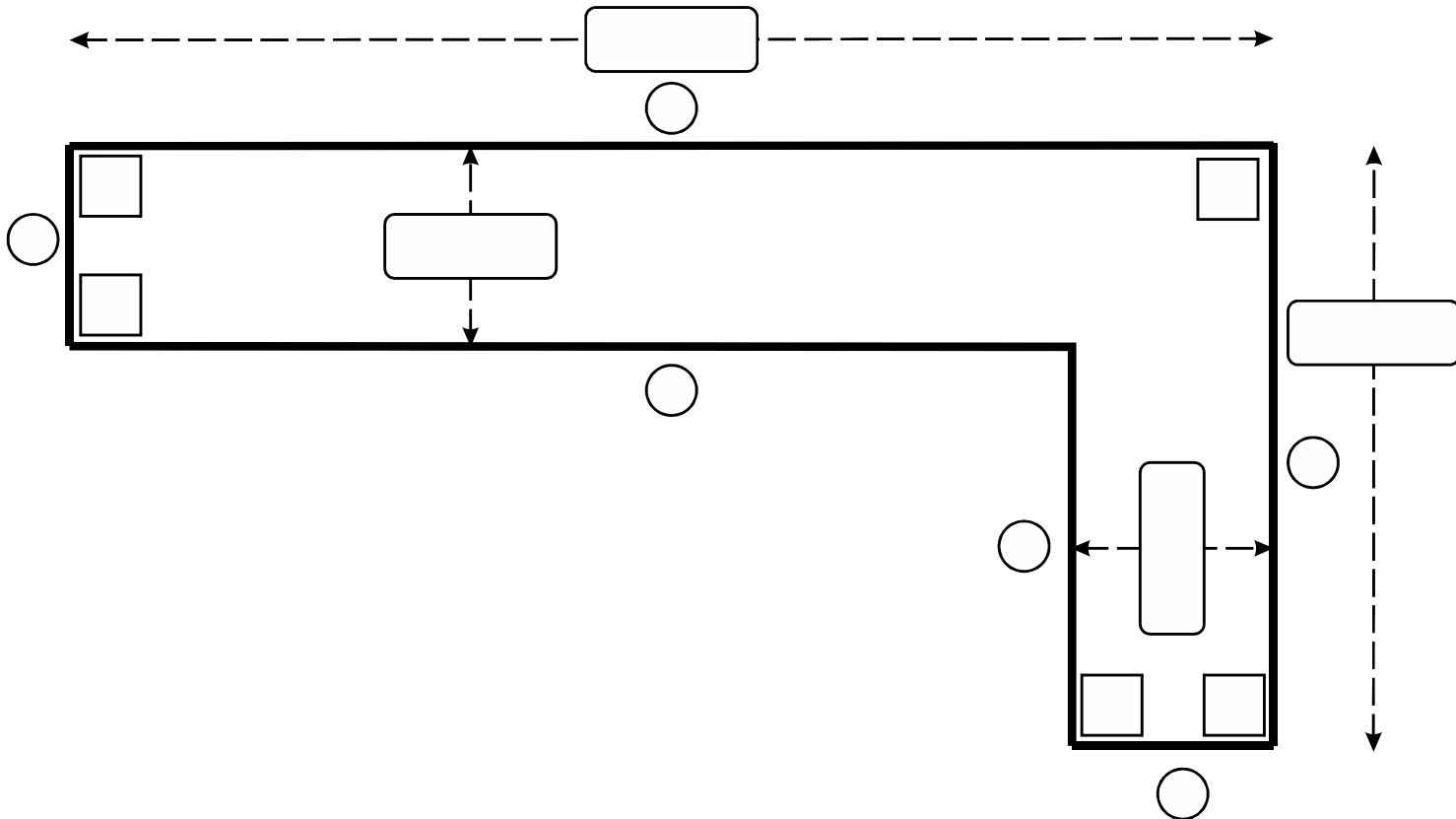

*** Countertops will be shipped unassembled at joints. All assembly hardware will be included.

1. SELECT MAIN EDGE PROFILE

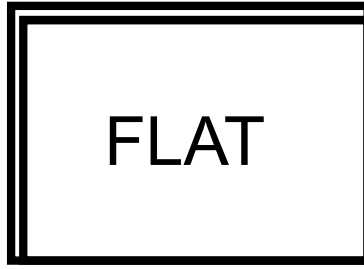
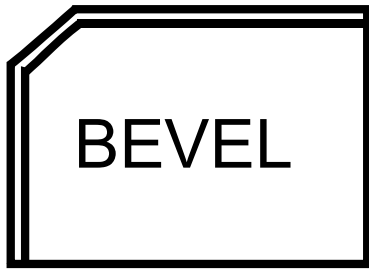

2. ENTER COLOR INFORMATION

<input type="text"/>	<input type="text"/>
QTY	Color / Pattern No. - Finish / Texture (ex: 1573-60)
<input type="text"/>	
Color / Pattern Name (ex: Frosty White)	

3. KEY

- ⓕ = flat laminated
- Ⓢ = unfinished
- Ⓣ = splash
- Ⓟ = profiled edge
- Ⓡ = radius (only on flat edges)

4. ENTER DIMENSIONS AND EDGE INFO (from # 3 key above)

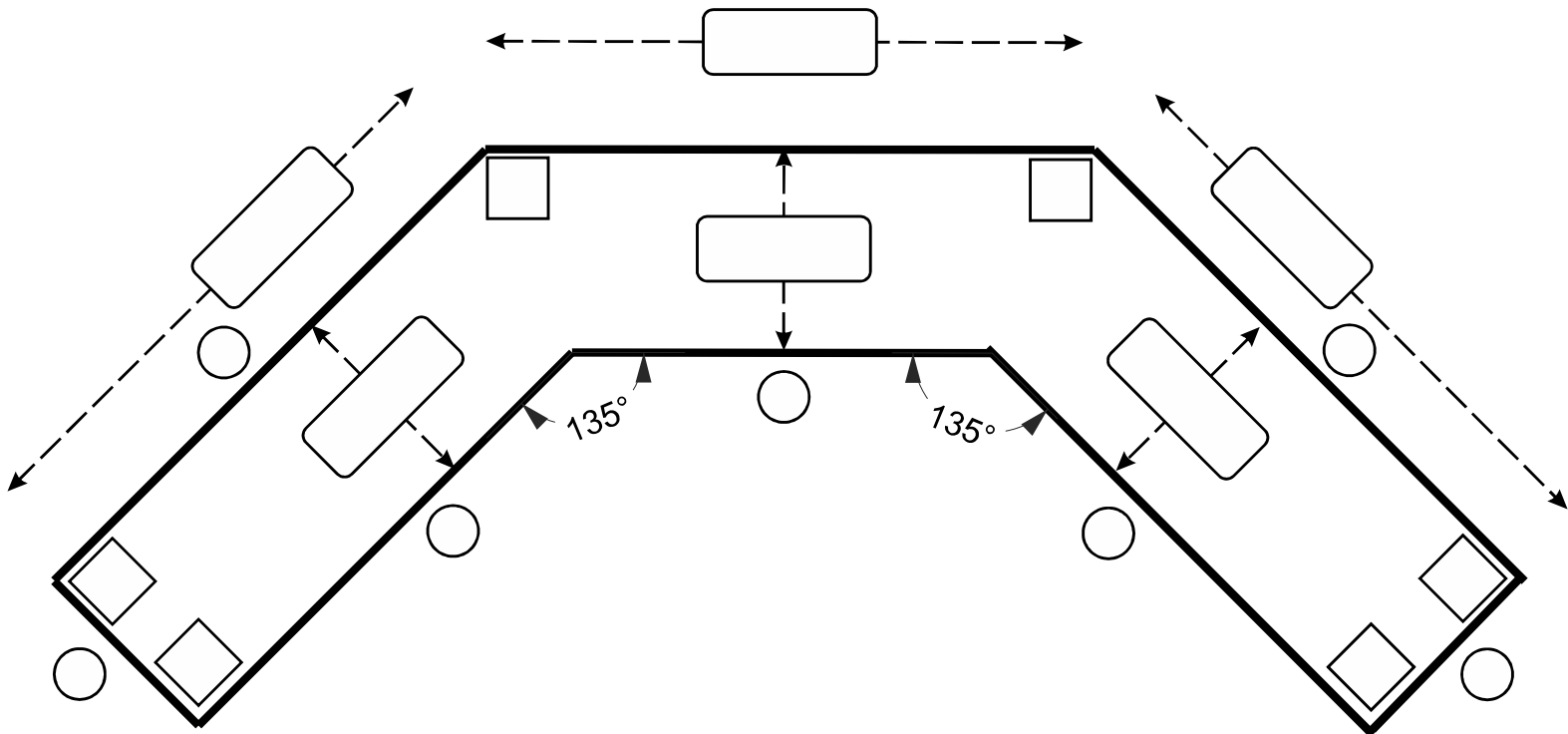

*** Countertops will be shipped unassembled at joints. All assembly hardware will be included.

1. SELECT MAIN EDGE PROFILE

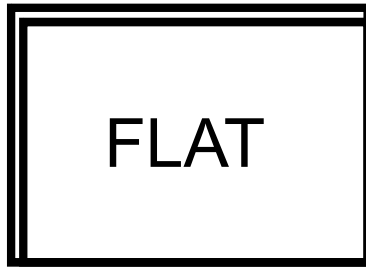
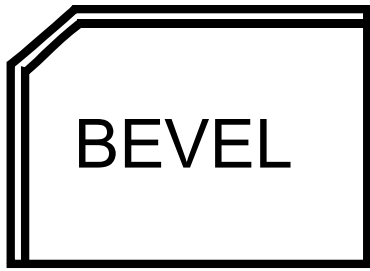

2. ENTER COLOR INFORMATION

<input type="text"/>	<input type="text"/>
QTY	Color / Pattern No. - Finish / Texture (ex: 1573-60)
<input type="text"/>	
Color / Pattern Name (ex: Frosty White)	

3. KEY

- ⓕ = flat laminated
- Ⓢ = unfinished
- Ⓣ = splash
- Ⓟ = profiled edge
- Ⓡ = radius (only on flat edges)

4. ENTER DIMENSIONS AND EDGE INFO (from # 3 key above)

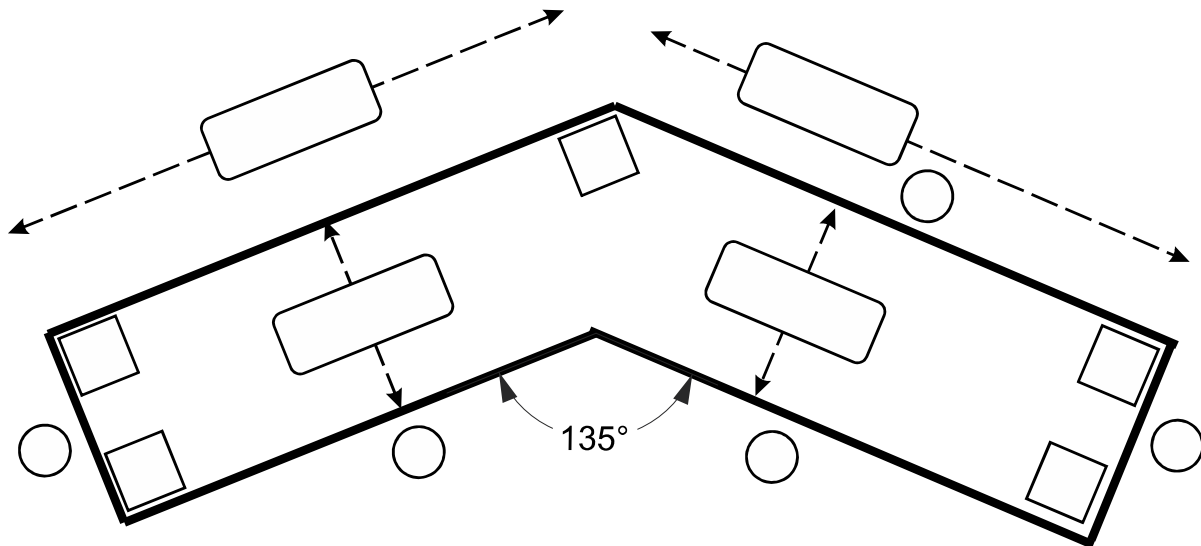

*** Countertops will be shipped unassembled at joints. All assembly hardware will be included.