

## Assembly of the ENTRY 7030 HALF

The installation of the ENTRY 7030 HALF is explained below. Prior to installation, please read the installation instructions carefully.

- 1 Remove the existing door lock cylinder by loosening the forend screw in the door and pulling out the cylinder with the key inserted (Fig. 1).
- 2 The basic measurements of the cylinder are 30/10 mm. Delivered, the outside knob is already preassembled. Attached to the cylinder is an adapter kit that enables you to adjust the cylinder to doors with a thickness of up to 67.5 mm (measured center fixing screw). Matching to the adapter lengths, the respective screws are attached (Fig. 2).

**Hint:** On the right side you will find the images of the adapters in 1:1 size.

**Hint:** For particularly thick doors, when it is necessary to use the larger adapters and the cylinder is somewhat loose on a long lever, you can optionally stabilize it with the cylinder extensions (the enclosed white plastic sleeves). To do this, slide the sleeve into the shaft below the cylinder in the door. Shorten the length of the sleeve if necessary.

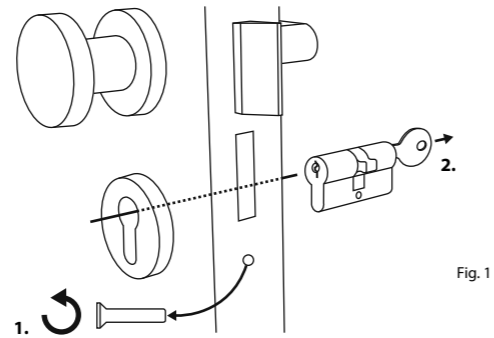

Fig. 1

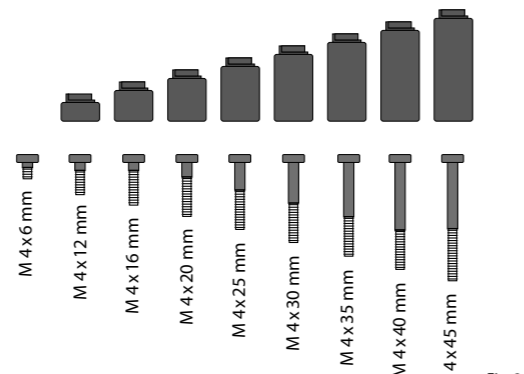

Fig. 2

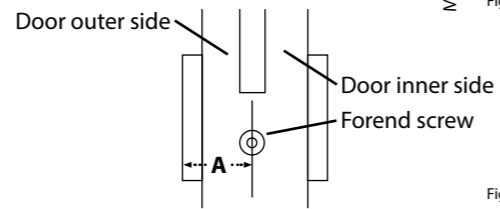

Fig. 3

	No adapter	Adapter 1	Adapter 2	Adapter 3	Adapter 4
<b>Measure A</b>	<= 29mm	29,5 - 34 mm	34,5 - 38,5mm	39 - 42,5mm	43 - 47,5mm
<b>Screw</b>	M4 x 6 mm	M4 x 12 mm	M4 x 16 mm	M4 x 20 mm	M4 x 25 mm

	Adapter 5	Adapter 6	Adapter 7	Adapter 8
<b>Measure A</b>	48 - 52,5 mm	53 - 57,5 mm	58 - 62,5 mm	63 - 67,5mm
<b>Screw</b>	M4 x 30 mm	M4 x 35 mm	M4 x 40 mm	M4 x 45 mm

Chart 1: Required adapter

## Screws and adapters in scale 1:1

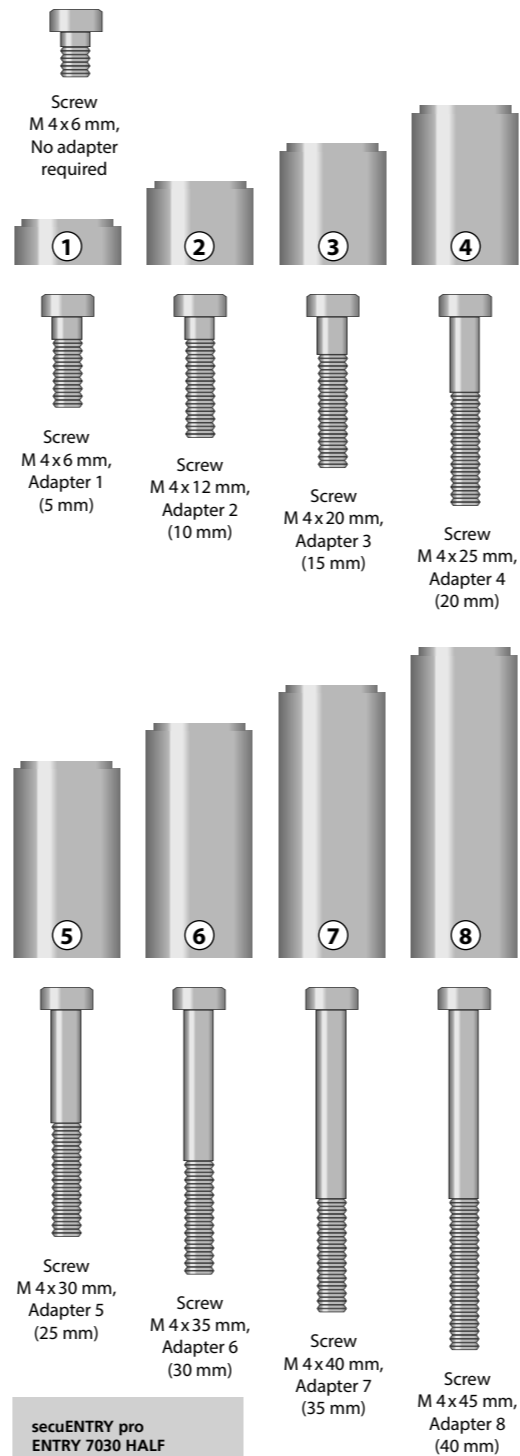

secuENTRY pro  
ENTRY 7030 HALF

1

**Attention!** It is important to ensure that the inner knob does not bump against anything as the knob can break. The lock must not be greased or oiled.

- 3 Proceed with installation as follows: Place cylinder on the door to check whether an adapter is needed. Alternatively, the door incl. metal fittings can be measured (measure A). If you want to use the rubber covering for the profile cylinder perforation, you need to add 2 mm each onto the measures.

**Achtung:** With the assembly it is important to regard that the lock bit functions centrally inside the mortise lock. It must not get in lateral contact with the mortise lock (Fig. 5).

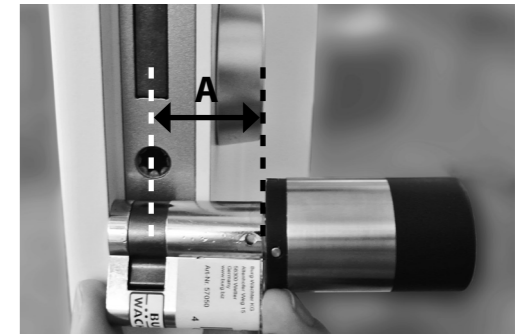

Fig. 4

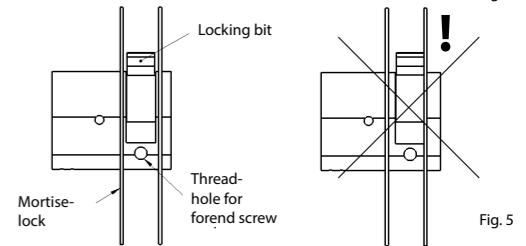

Fig. 5

## Assembly

Assembly for doors whose thickness incl. fittings are smaller than 29 mm on outer side and where the cylinder can be pushed from the inside to the outside through the profile cylinder opening.

- 1 Push the cylinder through the profile cylinder opening (Fig. 1).
- 2 Fixate cylinder with the fixing screw.
- 3 Perform a function test with the open door. Activate the lock via an opening device. Turn the knob in the opening and closing direction. The knob needs to be easy to turn. Afterwards, perform the test with the door closed.

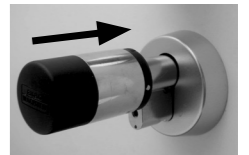

Fig. 1

## Assembly

Assembly for doors whose thickness incl. fittings are bigger than 29 mm on the outer side.

- 1 Press together the snap-in nose of the knob with the removal pliers and remove the cover. (Fig. 1/ Fig. 2).



Fig. 1

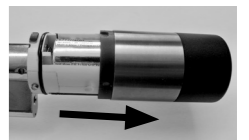

Fig. 2

secuENTRY pro  
ENTRY 7030 HALF

secuENTRY pro  
ENTRY 7030 HALF

2

② Carefully remove the plug (Fig. 3).

③ Unscrew the screw (Fig. 4).

! **Attention!** Do not damage the board or the cables!

④ Pull the knob from the cylinder and thread the cable out of the duct.

⑤ If required, assemble the cylinder extension and apply the cylinder with the cylinder extension (Fig. 5). The cylinder extension prevents a bracing of the cylinder.

⑥ Afterwards, fixate with the fixing screw.

⑦ Mark succinctly the cylinder extension with the fitting (Fig. 6).

⑧ Disassemble the cylinder with the cylinder extension and cut to desired length with a saw. Afterwards, assemble definitely with one of the attached M4x6 screws (Fig. 7).

⑨ Choose a matching adapter according to table 1 (page 1). Thread the plug through and push the adapter onto the cylinder. If required, you can stick on the mounting aid first (Fig. 8) and then push the plug through the adapter.

! **Attention:** Please check that the cylinder extension is shorter than the contact surface of the adapter (Fig. 9).

⑩ With the mounting aid, push the cable through the outer knob and store the cables inside the groove (Fig. 10/ Fig. 11).

! **Attention:** Do not crease or damage cables!

⑪ Click inside knob onto the adapter.

⑫ Keep cables sturdy and lead inside the groove (Fig. 12/ Fig. 13).

! **Attention!** The cables must not overlap and must be stored completely inside of the groove!



Fig. 3



Fig. 4



Fig. 5



Fig. 6



Fig. 7

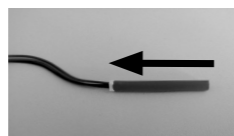

Fig. 8

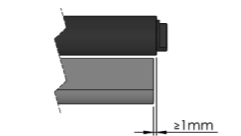

Fig. 9



Fig. 10



Fig. 11

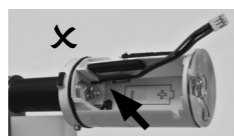

Fig. 12

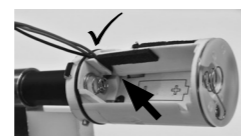

Fig. 13

⑬ Screw in tight the screw with the attached Allen key (Fig. 14).

! **Attention!** Do not crease or damage cables!

⑭ Connect cables via the plug connection with the board and store the excessive cables inside the provided side pocket (Fig. 15/ Fig. 16).

⑮ Insert batteries according to polarity (Fig. 17) and latch the shell (Fig. 18).

! **Please note:** The snapping only functions in one particular position!

⑯ Push the cylinder from the outside to the inside through the profile cylinder opening (Fig. 19) and fixate with the fixing screw.

⑰ Perform a function test with the open door. Activate the lock via an opening device. Turn the knob in the opening and closing direction. The knob needs to be easy to turn. Afterwards, perform the test with the door closed.



Fig. 14

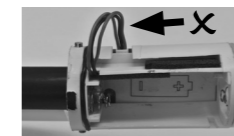

Fig. 15

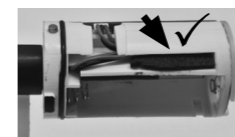

Fig. 16



Fig. 17

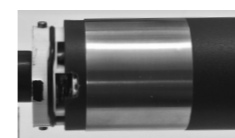

Fig. 18

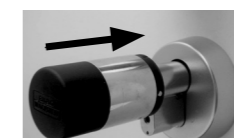

Fig. 19

## Warranty

In order to deliver a flawless and high quality product to you and to better assist you in case of service or repair, it is necessary that faulty or defective devices along with the valid administrator code and the QR code(s) be presented to your dealer together with the original documentation.

When returning goods due to your right of withdrawal, all parts of the appliance must also be in their factory settings. Failure to comply with this will invalidate the warranty.

## Disposal of the device

Dear customer,

Please help to reduce waste. Should you intend to dispose of this device at any time, please remember that many components of this device contain valuable materials that can be recycled.



Please note that electrical and electronic devices as well as batteries must not be disposed of with household waste but rather apart from it or separately. Please obtain information on the collecting points for electrical waste from the responsible authority of your city/municipality.



BURG-WÄCHTER KG hereby declares that this device complies with the Directives 2014/53/EU, (RED) and 2011/65/EU (RoHS).

The complete text of the EU Declaration of Conformity is available at the following Internet address <https://burg.biz/pages/eu-konformitaetserklaerung>.

Printing and typesetting errors as well as technical changes reserved.

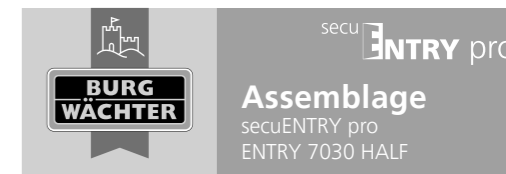

<https://t1p.de/burgsmart-app>

Your locking system is set up and can be operated using the free BURGsmart smartphone app, available in the Apple App Store and Google Play. You can find instructions on how to set it up on our website under the link above or via the QR code.



Further languages at:  
[www.burg.biz](http://www.burg.biz)