



secu **ENTRY** easy

Initial setup

secuENTRY easy

ENTRY 7602 FP

en



Setup with app
BURGsmart



Video instructions
Simple instructions on the setup and operation of your secuENTRY components. Follow the QR code or go to...
<https://t1p.de/burgsmart-app>

BURG-WÄCHTER KG
Altenhofer Weg 15
58300 Wetter
Germany

www.burg.biz

Contents index

en English 2

Further languages at:
www.burg.biz

Foreword

Dear Customer,

Thank you very much for deciding on the secuENTRY Set ENTRY 7602 FP, consisting of the ENTRY 7600 CYL cylinder and the ENTRY 7712 Keypad FP.

The system was developed in Germany according to the most modern technical capabilities and fulfils the latest high safety requirements.

The ENTRY 7600 CYL electronic cylinder can be easily installed in any door with a mortise lock, up to a door thickness of 118 mm (59/59 mm, measured in the centre of the forend screw). No drilling or laying of cables is required and it is ideally suited for both new installations and retrofitting. The ENTRY 7600 CYL can be fitted to house and interior doors.

Using the ENTRY 7712 Keypad FP, you can unlock and lock the door with a 6-digit user code or fingerprint. The ENTRY 7712 Keypad FP can be installed up to approx. four metres from the locking unit, depending on preference and conditions.

The ENTRY 7600 CYL is setup and operated using the free smartphone app BURGsmart*. The transmission is wireless, the cylinder uses the modern Bluetooth 5.2 standard.

* Alternatively, the cylinder can also be operated by keypad (e.g. ENTRY 7711 Keypad PIN), the radio key ENTRY sE-Key 7713, as well as other add-on products (all items available separately. For a complete list of all compatible products, please refer to page 15 of these instructions). The BURGsmart app is however always required for the setup.

! Important:

- Please read the entire operating instructions before you start the installation.

We hope you enjoy your new locking system!

Set contents

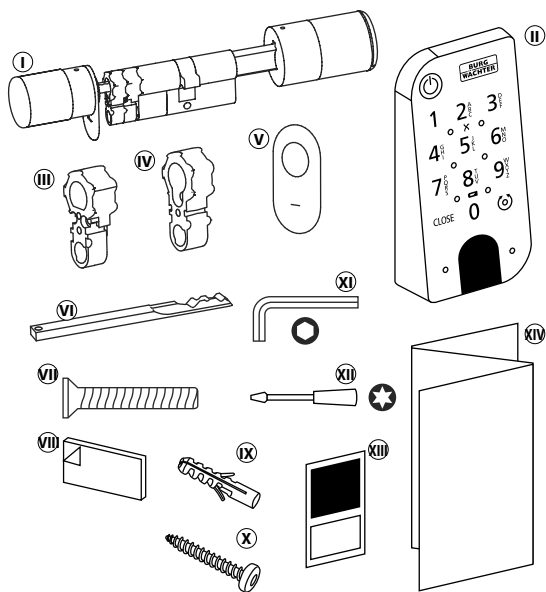

Fig. 1

① ENTRY easy 7600 CYL Cylinder
② ENTRY 7712 Keypad FP
③ Adapter 1 incl. 2x M2x10 screws
④ Adapter 2 incl. 1x 2.9x13 screw
⑤ Emergency lock cover (2x)
⑥ Emergency key
⑦ Forend screw
⑧ Adhesive pads (4x)
⑨ Dowels (3x)
⑩ Screws (3x)
⑪ Hexagon spanner SW2
⑫ Screwdriver TX8
⑬ QR-Code sticker
⑭ Quick Start Guide plus warranty and disposal instructions

QR code/Administrator code

The QR codes (I) are required later when setting up the set using the BURG-WÄCHTER BURGsmart app (Fig. 1).

The sets are delivered from the factory with a random administrator code (II) (Fig. 1), consequently a code change is not mandatory.

! Attention:

Neither the QR codes nor the factory-generated administrator code are stored by BURG-WÄCHTER. Recovery is not possible if the codes are lost. It is important to keep the QR code stickers enclosed with the set in a safe place. We further recommend that you photograph the stickers and also archive them digitally.

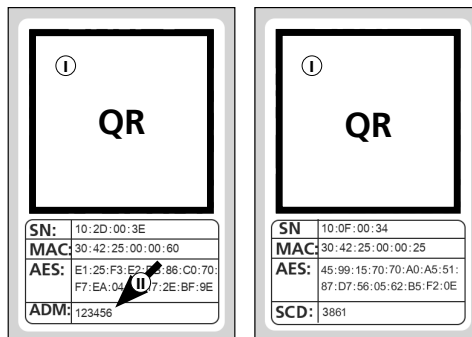

Cylinder QR code sticker

Keypad QR code sticker

Fig. 1

Technical data - ENTRY 7600 CYL Cylinder

Cylinder unit power supply	2x Mignon LR6 AA Alkaline
Permitted ambient conditions	-15 °C/+50 °C / up to 95 % relative humidity (non-condensing)
Radio standard	Bluetooth 5.2 LE
Transmission power	≤ 10 dBm
Frequency range	2.4 - 2.483 GHz
Range	Approx. 4 m
Number of access media	Up to 2,000 user codes (incl. one administrator code)*, sE keys** or BURGsmart connections, of which max. 45 fingerprints*** when using a fingerprint keypad or 300 when using the PC software****.
Blocking times	After 3x incorrect entries of an opening media 1 minute, thereafter 3 minutes each time

! Note:

The integrated manipulation protection in the cylinder ensures that the cylinder is blocked for one minute after three incorrect entries of an opening media. From the fourth incorrect entry, the cylinder is blocked for three minutes each time.

Technical data - ENTRY 7712 Keypad FP

Keypad power supply	2x Mignon LR6 AA Alkaline
Permitted ambient conditions	-15 °C/+50 °C / up to 95 % relative humidity (non-condensing)
Radio standard	Bluetooth 5.2
Transmission power	≤ 10 dBm
Frequency range	2.4 - 2.483 GHz
Range	Approx. 4 m
Weather protection class (IP class)	IP43

* The user code can only be used as an opening media in conjunction with the ENTRY 7711 keypad PIN, ENTRY 7712 keypad FP or ENTRY 7722 keypad FP (available as an option, ENTRY 7711 PIN included in the set).

** Radio key ENTRY sE-Key 7713 available as an option.

*** The fingerprint can only be used as an opening media in conjunction with the fingerprint keypad ENTRY 7712 Keypad FP or ENTRY 7722 Keypad FP (available as an option).

**** Additional input of fingerprints is possible using Windows software ENTRY 7783 Pro and the programming device ENTRY 7073 Enrolment (both available as an option).

ENTRY 7712 Keypad FP

The *ENTRY 7712 Keypad FP* can be used to operate electronic secuENTRY cylinders from BURG-WÄCHTER. Communication between the keypad and the profile cylinder is 128-bit AES encrypted.

Operation on the illuminated keypad is carried out via push-buttons. Consequently, the keypad can be easily operated even in poor lighting conditions.

The *ENTRY 7712 Keypad FP* enables the door to be opened and closed with the aid of a 6-digit PIN code (= 1 million number combinations) or by fingerprint.

The keypad is spray water protected on all sides according to IP43 certification.

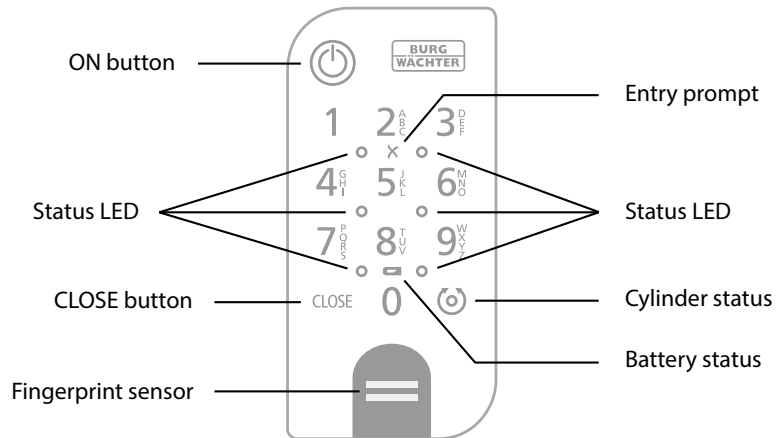

	ON button	Activates the keypad. An entry "Opened" (ON button) or "Closed" (CLOSE button) is generated in the secuENTRY cylinder history.
	CLOSE button	This allows for the "Open" and "Close" operations to be differentiated in the history.
	Error message	The two LEDs next to the X symbol will illuminate if an invalid number combination is entered or if general errors occur.
	Battery status	The system monitors the keypad and cylinder battery voltage. The user is alerted as soon as the battery voltage reaches a critical range. Batteries must be changed as soon as possible after the battery status symbol illuminates.
	Cylinder status	When the number combination entered is correct, the cylinder status symbol will illuminate and the door can be unlocked or locked.
	Status LED	The LEDs illuminate one after the other in a clockwise direction when the keypad is in programming mode (see chapter below).

Set the keypad to programming mode

Please refer to this chapter if the keypad has to be set to programming mode in the course of the setup. Position the smartphone and keypad within Bluetooth range of each other and carry out the following steps.

- When you reach the view shown in the illustration (Fig. 1), briefly lay the smartphone aside and set the keypad to programming mode using the following steps.

Attention: In order for the data transfer between smartphone and keypad to occur, the smartphone must be in direct proximity to the keypad for the following step (Bluetooth range)

- Activate the keypad with the ON button (Fig. 2).

- Enter the security code (SCD) provided using the keypad.

Note: The security code can be found on the enclosed QR code sticker (Fig. 3).

Note: The security code (SCD) serves as manipulation and theft protection

- Press and hold the CLOSE button for five seconds (Fig. 4) until the signal LEDs on the keypad illuminate one after the other in a clockwise direction (Fig. 5).

- The keypad is now in programming mode. Perform the further steps using the smartphone again (Fig. 6).

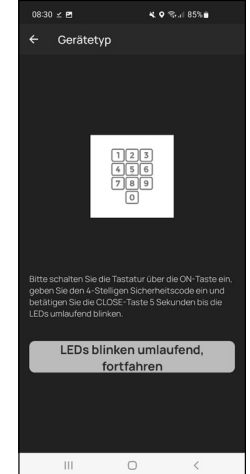
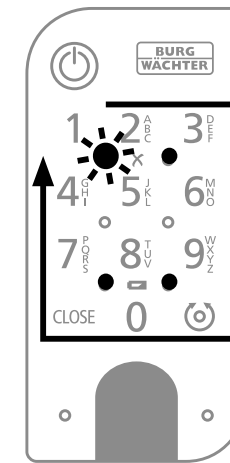
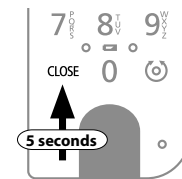
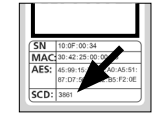
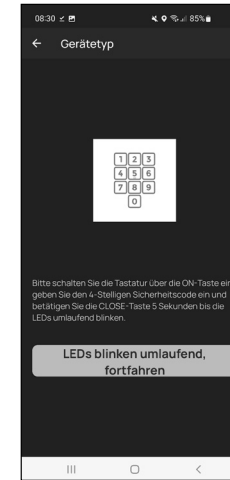

ENTRY easy 7602 FP activation

- 1 First of all, download the *BURGS*mart app in order to be able to set up your new locking system. This can be found in the iOS App Store and Google Play Store (Fig. 1).



Fig. 1

- ! **Note:** The Android version of the *BURGS*mart app has been used for these instructions. The iOS version can be slightly different visually, but the work steps are identical.

- 2 You will be shown licence provisions for the use of the app when you open it for the first time. Carefully read them and then confirm by clicking "OK" in the bottom right-hand corner (Fig. 2).
- 3 Enter your name and a mail address (Fig. 3).
- 4 Select them the item: "*BURG-WÄCHTER Cloud*" this is not required for the setup and can therefore be ignored for the time being (Fig. 3). An explanatory note on this subject can be found in the master operating instructions on our website (see link on the title page).

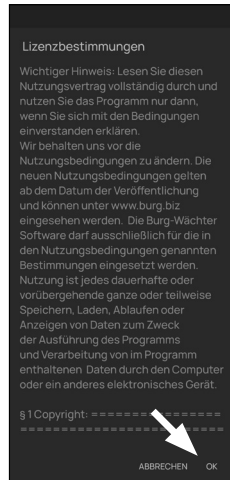

Fig. 2

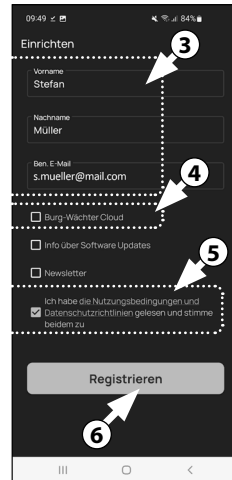

Fig. 3

- 5 Read through and agree to the terms of use and privacy policy (Fig. 3).
- 6 Tap on "Register" (Fig. 3).

- ! **Note:** An e-mail window opens with a mail template which you can use to send the registration data to the specified e-mail address. This is necessary, for example, when using the secuENTRY Windows software. It is not required for the setup described here. The data can also be called up again in the app at a later time if required.

- 7 The *BURGS*mart app main screen appears. Open the "My System" menu at the bottom left (Fig. 4).

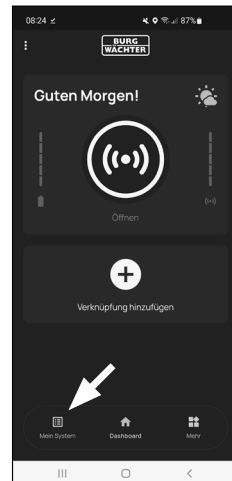

Fig. 4

I - User

- 1 Tap on the menu item "I - User" (Fig. 1).
- 2 A list of the users that have already been created is displayed. A user profile with a lock opening via smartphone has already been automatically created for the administrator. Tap on this (I) (Fig. 2).

- ! **Note:** Alternatively, a new additional user profile can be created at this point. To do so, tap the "+" in the top right-hand corner (II) (Fig. 2).

User data

- 3 An overview of the user data appears. If you have created a new user, first enter the first name and surname of the user (I) (Fig. 3).

Access data

- ! **Note:** This section allows you to enter the desired opening media (e.g. user code or fingerprint) for the user (II) (Fig. 3). The lock opening by smartphone is automatically stored in the administrator's user profile.

Access data | User code

- 4 Enter a required 6 digit user code under "Enter 6-digit code" (III) (Fig. 3).

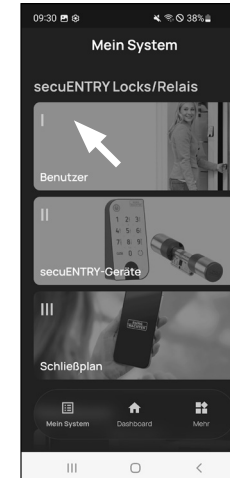

Fig. 1

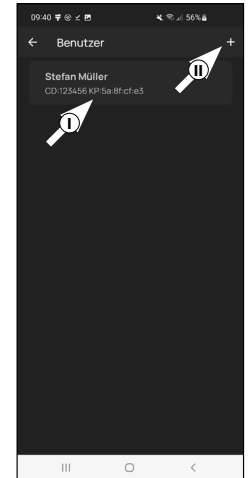

Fig. 2

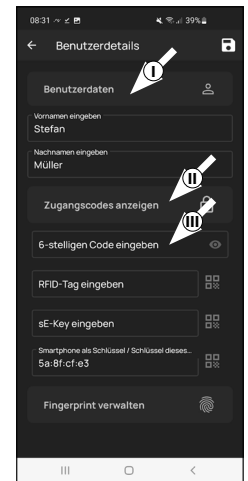

Fig. 3

Access data | Enter RFID tag

- An RFID transponder *ENTRY 7710 RFID* (optionally available) can be entered at this point. Instructions on how to set this up can be found in the RFID transponder instructions (I) (Fig. 4).

! **Attention:** This cylinder in this set requires the add-on article *ENTRY 7174 RFID Extender* for the use of RFID transponders. For a complete list of all compatible products, please refer to page 17 of these instructions.

Access data | Enter sE-Key

- A radio key *ENTRY sE-Key 7713* (optionally available) can be stored at this point (II) (Fig. 4). Instructions on how this is setup, please refer to the radio key instructions.

Access data | Smartphone as key

! **Note:** The lock opening by smartphone is automatically stored in the administrator's user profile (III) (Fig. 4). A different smartphone as the electronic key can be stored in this field for additional users. An instructions on this subject can be found in the master operating instructions on our website (see link on the title page).

Manage fingerprint

- This section allows you to register a finger as an opening media. Tap on the fingerprint symbol to the right of the "Enter fingerprint" field (Fig. 5).

! **Note:** The "Enter fingerprint" field edits entries that already exist, which means that the field has no function without an entry. Instead, tap the fingerprint symbol to the right of it.

- A display of already created keypads appears. This is empty during the initial setup. Tap on the "+" in the top right-hand corner to connect a keypad. (Fig. 6).

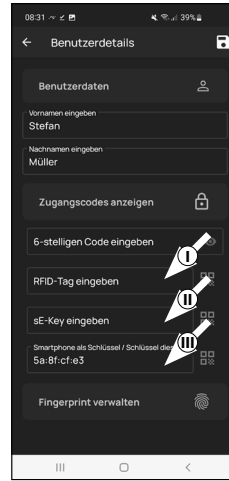

Fig. 4

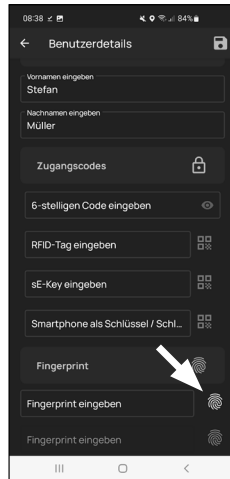

Fig. 5

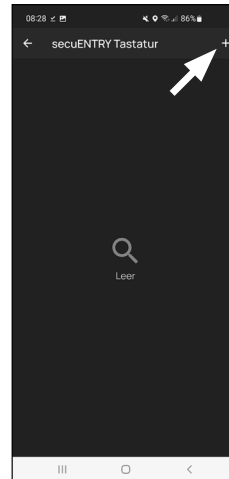

Fig. 6

- A prompt will appear asking you to scan the QR code for the keypad provided using your smartphone camera. The QR code is on the QR code sticker enclosed in the packaging (Fig. 7).

! **Attention:** The set comes with two QR code stickers, one for the cylinder and one for the keypad. The QR code required here for the keypad can be identified by the security code at the bottom of the sticker, marked "SCD" (Figure "QR code sticker keypad" in Fig. 8).

- Tap on "Scan QR code" (Fig. 7). You may be asked to confirm the app's access to the camera.

- The capture window of the camera opens. Scan the QR code.

- After the QR code has been scanned, a message appears containing data regarding your cylinder; confirm this with "OK" at the bottom right (Fig. 9).

- In the following window, you will be prompted to assign a name for the keypad. Where several cylinders and secuENTRY components are used, it is recommended to name the keypad in such a way that you can directly identify what it is and where the keypad is located or attached. In the example in these instructions, the keypad is titled "Front door keypad". Confirm the name with "OK" (Fig. 10).

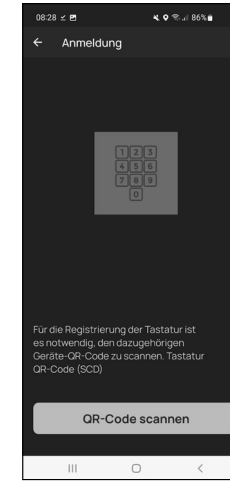

Fig. 7

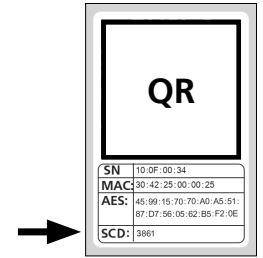

Fig. 8
Keypad QR code sticker

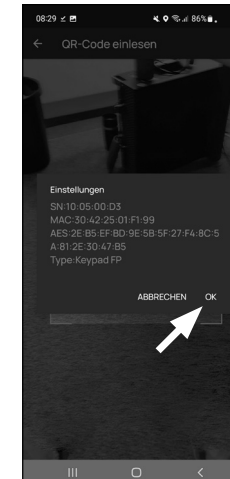

Fig. 9

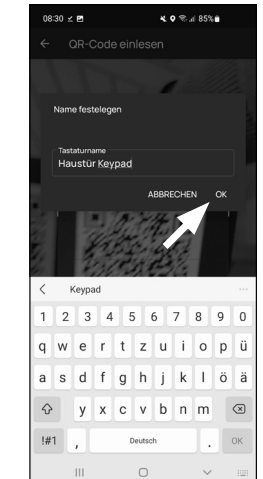

Fig. 10

! Attention: The following step requires the smartphone, keypad and cylinder to be in direct proximity to each other (Bluetooth range).

14 You will be asked to set the keypad to programming mode (Fig. 11). Instructions on how to do this can be found in the chapter "Setting the keypad into programming mode" on page 3. As soon as the keypad is in programming mode, indicated by the LEDs on the keypad flashing continuously, tap the "LEDs flashing continuously, continue" key in the app (Fig. 11).

15 Now slowly move the chosen finger several times from top to bottom over the sensor on the keypad (Fig. 12/13). Observe the instructions in the app (Fig. 14).

16 Repeat until the app reports that registration is complete (Fig. 15).

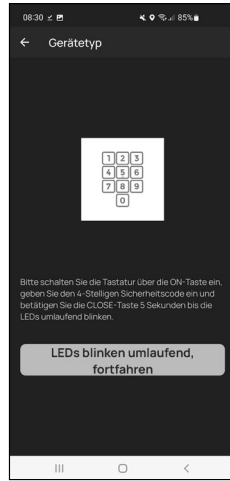

Fig. 11

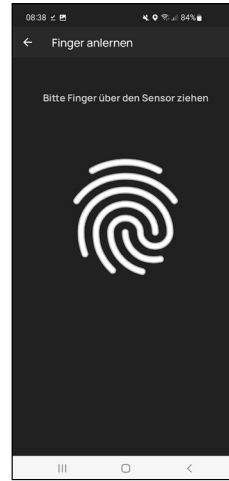

Fig. 12

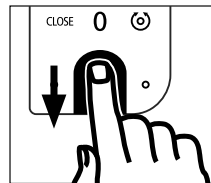

Fig. 13



Fig. 14



Fig. 15

6 Once a finger has been entered, the entry "Fingerprint saved" (I) appears in the corresponding field (Fig. 16). Below this, there is also a new, empty field for a further fingerprint (II) (Fig. 16).

7 A further finger can be registered here, if required. To do this, follow the steps in this chapter once again.

8 Then tap on Save (I) in the top right-hand corner (Fig. 17). An info box with "Update successful" appears for confirmation (II) (Fig. 17).

! Note: If you wish to enter opening media for other users, go back one menu and select the respective user (Fig. 18). Repeat the steps in this chapter for this user.

8 You can now leave the menu (I - User). Return to the "My System" menu (Fig. 19).

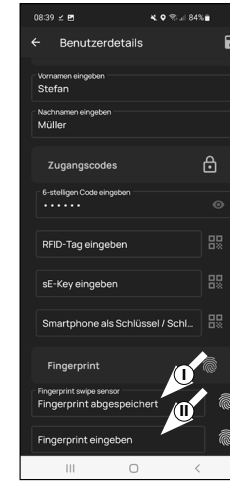

Fig. 16

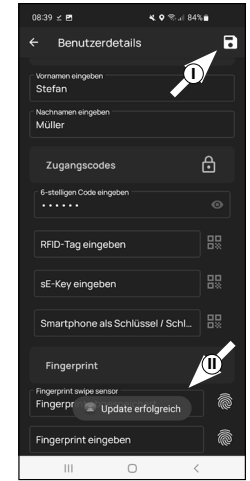

Fig. 17

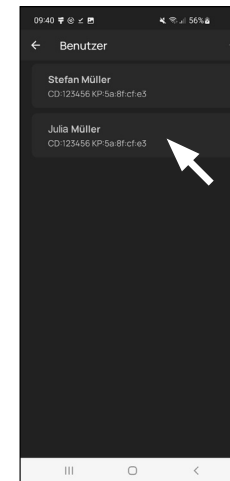

Fig. 18

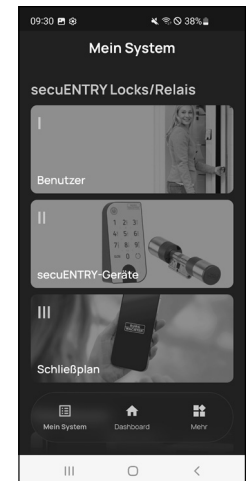

Fig. 19

II - secuENTRY units

- 1 Tap on the second menu item „II - secuENTRY units“ (Fig. 1).
- 2 The app displays a list of the cylinders that have already been registered. This is empty during the initial setup. Setup a new cylinder by tapping on the „+“ in the top right-hand corner (Fig. 2).

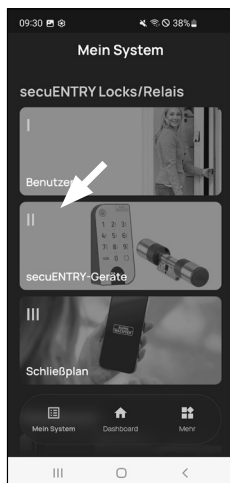

Fig. 1

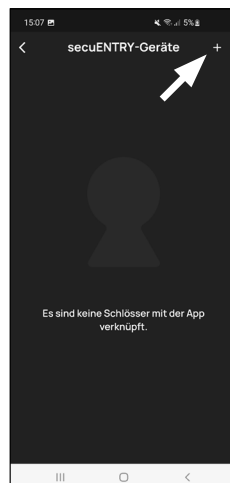

Fig. 2

- 3 A prompt will appear asking you to scan the cylinder QR code provided using your smartphone camera. The QR code is on the sticker enclosed in the packaging (Fig 3).

Attention: The set comes with two QR code stickers, one for the cylinder and one for the keypad. You can identify the QR code required here for the cylinder by the administrator code at the bottom of the sticker, marked „ADM“ (Fig. 3).

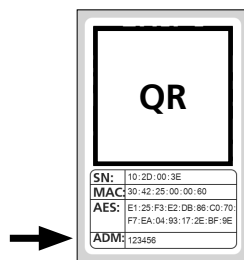

Fig. 3
Cylinder QR code

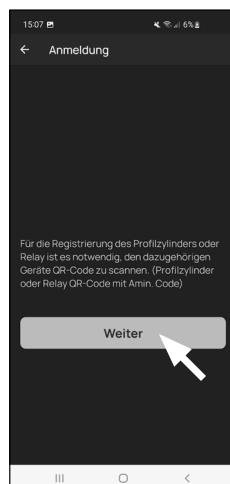

Fig. 4

- 4 Tap on „Next“ (Fig. 4). You may be asked to confirm the app's access to the camera.

- 5 The capture window of the camera opens. Scan the QR code.
- 6 A message appears containing data regarding your cylinder; confirm this with „OK“ at the bottom right (Fig. 5).
- 7 In the following window, you will be prompted to assign a name for the cylinder. Where several cylinders and secuENTRY components are used, it is recommended to name the cylinder in such a way that you can directly identify what it is and where the cylinder is located or attached. In the example in these instructions, the cylinder is titled „Front door cylinder“. Confirm the name with „OK“ (Fig. 6).
- 8 A message appears informing you that you can change your administrator code. As you received a randomly generated administrator code at the time of delivery, this step is optional. You can bypass this with „Skip“ (Fig. 7).

! Note: The randomly generated administrator code can be found on the enclosed QR code sticker under „ADM“. The administrator code can be changed at any time at a later date. Refer to the master operating instructions on our website for an explanation on this subject (see link on the title page).

- 9 In order for the keypad to receive the information on which cylinder it is to control, this cylinder must be available and assigned within the app.

The next menu (Fig. 8) offers you the following three options:

- „Link to an existing keypad“: You have already setup a keypad in the app and want to link it again.
- „Link to a new keypad“: You have another keypad and want to link it to the app.
- „Skip“: Carry out this step at a later date.

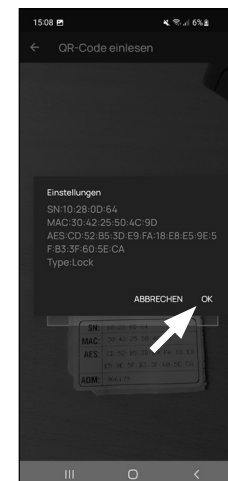

Fig. 5

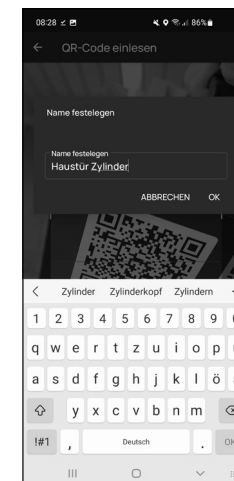

Fig. 6

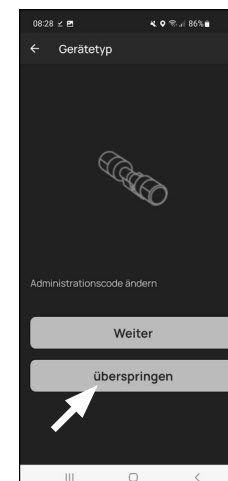

Fig. 7

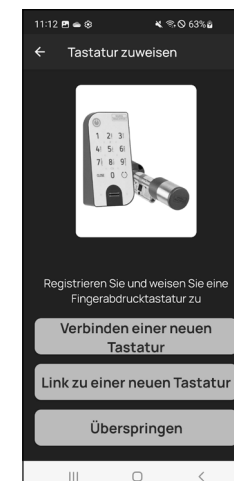

Fig. 8

Tap on „Link to a new keypad“ if you have not yet setup a keypad (Fig. 9). Setup your keypad using the previous steps..

- ! Note:** A description on keypad setup can be found in chapter „I - Users“, starting with the subchapter „Manage fingerprint“ (see page 5, from point 7).

10 If you have already setup the keypad in the previous chapter, „I - Users“, during the fingerprint setup, tap on „Link to an existing keypad“.

11 Tap the entry for the corresponding keypad in the list of registered keypads (I) (Fig. 10) and then tap „Assign lock“ in the menu window that appears (II) (Fig. 3).

12 The app displays a list of the cylinders that have already been registered. Select the cylinder required (I) (Fig. 11) and tap on „Continue“ in the top right-hand corner

! Attention: The following step requires the smartphone, keypad and cylinder to be in direct proximity to each other (Bluetooth range).

13 You will be asked to set the keypad to programming mode (Fig. 5). Instructions on how to do this can be found in the chapter „Setting the keypad into programming mode“ on page 3. As soon as the keypad is in programming mode, indicated by the LEDs on the keypad flashing continuously, tap the “LEDs flashing continuously, continue” key in the app (Fig. 5).

14 If the link is successful, a completion message appears, which can be confirmed with “OK”. The same applies to the subsequent “Done” field to complete the setup.

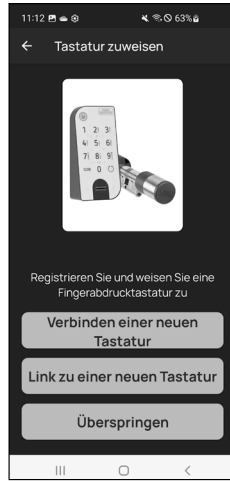

Fig. 9

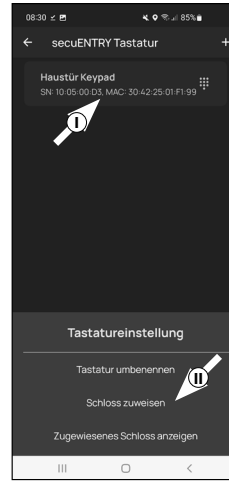

Fig. 10



Fig. 11

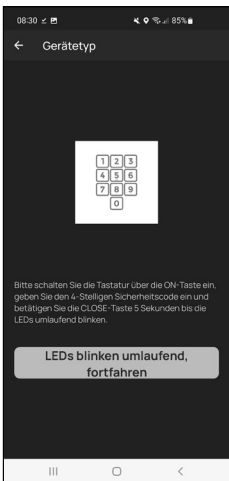

Fig. 5

III - Locking plan

- 1 Use this menu to define the locking plan, namely which user is allowed to open which lock. The data is then transferred to the cylinder.
- 2 Open the “My System” menu (I) (Fig. 1).
- 3 Tap on the fourth menu item “III - Locking plan” (Fig. 1).
- 4 A table is displayed consisting of the existing cylinders (horizontal) and the configured users (vertical) (Fig. 2). Select the checkbox where you wish to authorise the respective user to use the corresponding lock (I) (Fig. 2) and then click on the button „Save changes“ (II) (Fig. 2).

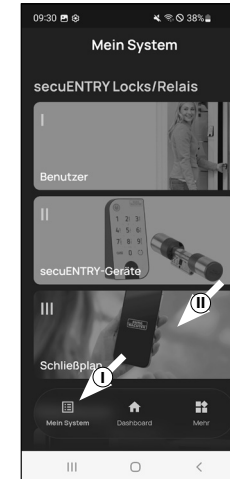

Fig. 1

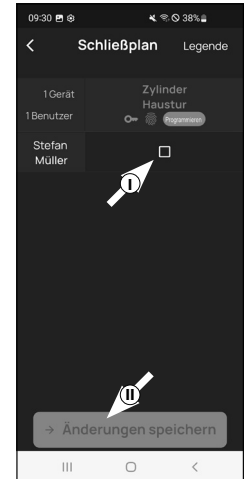

Fig. 2

! For info: This table is of interest when you have several cylinders and users. This allows you to clearly determine in one step who is allowed to access which cylinder. Fig. 3 provides an example of what a completed table with corresponding cylinders and users might look like.

! Attention: The following step requires the smartphone, keypad and cylinder to be in direct proximity to each other (Bluetooth range).

- 5 If any changes have been made to the locking plan, the display of the respective cylinder appears red and the „Program“ button is displayed. This indicates that the settings have not yet been transferred to the cylinder. To do this, tap the red „Program“ button for the respective cylinder (Fig. 4).

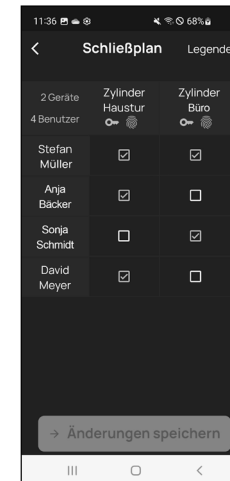

Fig. 3

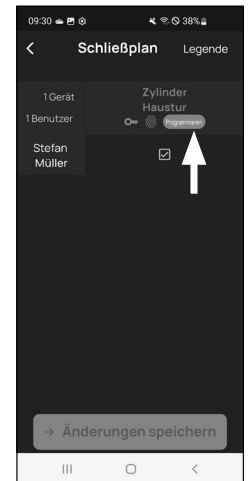

Fig. 4

⑥ Here you will be asked to verify yourself with your administrator code. Enter the code and confirm with "OK" (Fig. 5).

! **Note:** The factory administrator code can be found on the QR code sticker of the cylinder under "ADM" (Fig. 9).

⑦ The data will be transferred. A confirmation will appear after a brief moment and at the same time a request to now assign the keypad. Tap on the confirmation message (Fig. 6).

⑧ Select the required keypad (Fig. 7).

⑨ You will be asked to set the keypad to programming mode (Fig. 8). Instructions on how to do this can be found in the chapter "Setting the keypad into programming mode" on page 3. As soon as the keypad is in programming mode, indicated by the LEDs on the keypad flashing continuously, tap the "LEDs flashing continuously, continue" key in the app (Fig. 8).

⑩ Nach einem kurzen Moment erhalten Sie eine Rückmeldung, dass die Daten übertragen wurden. Bestätigen Sie mit „OK“.

The setup is now completed.

Repeat the steps in the respective chapters if you wish to integrate further components into your system at a later date, change access data or create additional users.

Please note: All changes and additions are carried out within the app and must then be transferred to the respective secuENTRY component. This last chapter, "Locking plan" (page 8) and "Transfer locking plan" (page 9) must be completed in each case in order to be able to use them in your components.

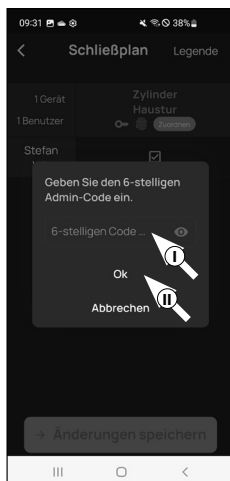

Fig. 5

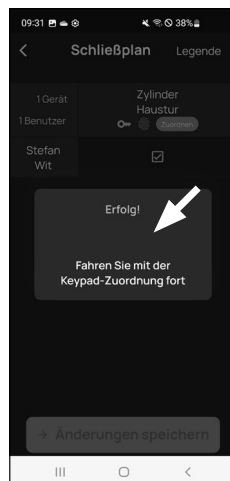

Fig. 6

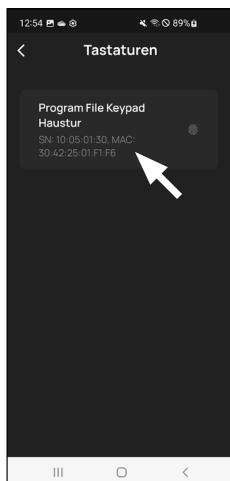

Fig. 7



Fig. 8

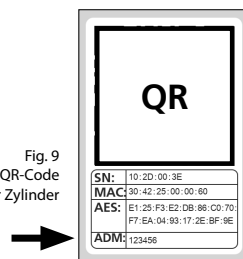

Fig. 9
QR-Code
Aufkleber Zylinder

Using the cylinder and keypad

To use the cylinder (Fig. 1) and keypad (Fig. 2), remove the battery protection strips.



Fig. 1

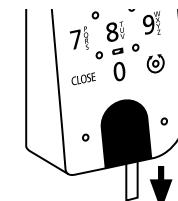

Fig. 2

Opening the secuENTRY lock

The ENTRY 7602 FP set enables you to open the lock via the BURGsmart app or the keypad using a user code or fingerprint, provided you have set up the corresponding opening media in accordance with these instructions.

Opening the secuENTRY lock with the BURGsmart app

Proceed as follows to open the ENTRY 7600 CYL cylinder and consequently also the door:

① Open the BURGsmart app and press the "ACCESS" button in the middle (Fig. 1).

! **Note:** The BURGsmart app is programmed so that when more than one cylinder is used, it automatically adjusts to the cylinder that is within the shortest distance of the smartphone. Each cylinder can be opened by pressing the "ACCESS" button.

② The cylinder is now released and the lock can be opened (Fig. 2) or locked (Fig. 3).

! **Note:** Depending on the door stop, the direction of rotation may be reversed.

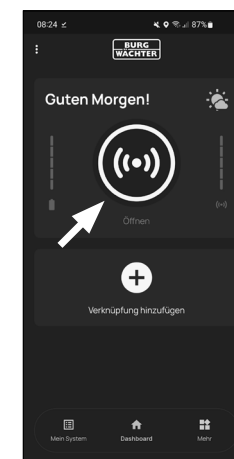

Fig. 1

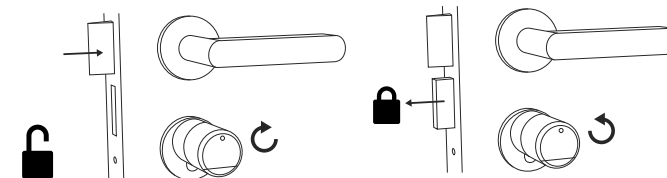

Fig. 2

Fig. 3

Opening the secuENTRY lock via the keypad (user code)

- 1 Activate the keypad by pressing either the ON key or the CLOSE key (I) (Fig. 4).

An entry "Opened" (ON button) or "Closed" (CLOSE button) is generated in the cylinder history. This allows for the "Open" and "Close" operations to be differentiated in the history.

- ! **Note:** Further details on the history function can be found in the master operating instructions on our website (see link on the title page).

- 2 Enter your 6-digit administrator code or programmed user code (II) (Fig. 4).

- ! **Note:** Further details on the subjects of administrator and user codes can be found in the chapters "QR code/administrator code" on page 2 and "I-User" on page 4, as well as in the master operating instructions on our website (see link on the title page).

- 3 When the number combination entered is correct, the cylinder status symbol (⊙) will illuminate and the door can be unlocked (Fig. 5) or locked (Fig. 6).

- ! **Note:** Depending on the door stop, the direction of rotation may be reversed.

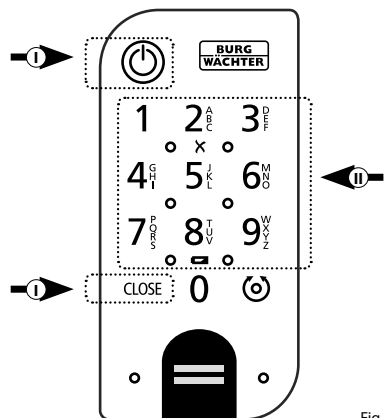

Fig. 4

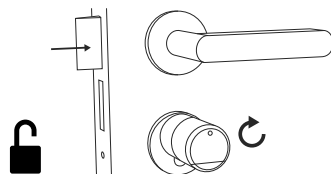

Fig. 5

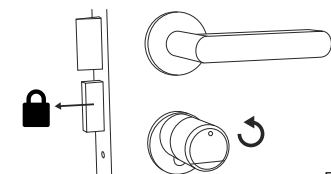

Fig. 6

Opening the secuENTRY lock via the keypad (fingerprint)

- 1 Activate the keypad by pressing either the ON key or the CLOSE key (Fig. 7).

An entry "Opened" (ON button) or "Closed" (CLOSE button) is generated in the cylinder history. This allows for the "Open" and "Close" operations to be differentiated in the history.

- ! **Note:** Further details on the history function can be found in the master operating instructions on our website (see link on the title page).

- 2 Move the fingertip of the registered finger from top to bottom over the sensor field (Fig. 8).

- ! **Note:** Further details on the subjects of administrator and user codes can be found in the chapters "QR code/administrator code" on page 2 and "Creating and managing users" on page 7, as well as in the master operating instructions on our website (see link on the title page).

- 3 When the fingerprint entered is correct, the cylinder status symbol (⊙) will illuminate and the door can be unlocked (Fig. 9) or locked (Fig. 10).

- ! **Note:** Depending on the door stop, the direction of rotation may be reversed.

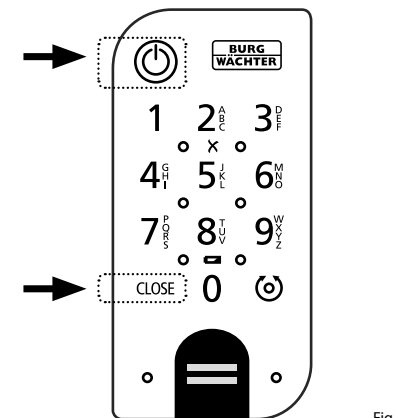

Fig. 7

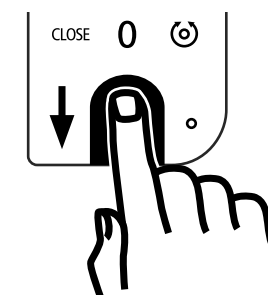

Fig. 8

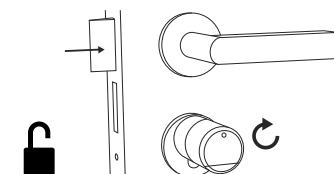

Fig. 9

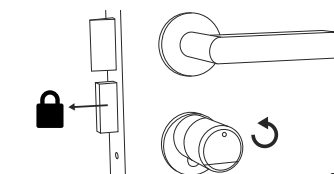

Fig. 10

Opening the secuENTRY lock with the emergency lock

Should the batteries in the locking cylinder be completely discharged, the lock can still be opened mechanically. The emergency lock is located on the outer side, below the knob attachment.

! Note: When the assembly steps in these instructions have been completed, the emergency lock is behind a cover and is not directly visible.

① To open the lock, open the emergency key at the joint and then insert it through the indicated slot on the emergency lock cover (Fig. 11).

② Turn the key 90 degrees clockwise. If required, move the outside knob slightly to the right and left in order to release the mechanism. The lock is open after at least two full turns of the cylinder knob.

③ After opening the door, turn the emergency key back to its original position (90 degrees counter-clockwise) and remove it.

④ To return the locking cylinder to its regular locking position, turn the outside knob two complete turns in both directions. This engages the mechanism and the emergency lock is fully closed.

! Note: When the emergency lock is used, the keyhole indication on the emergency lock cover is torn. A second cover is included in the set so that it can be replaced for aesthetic reasons.

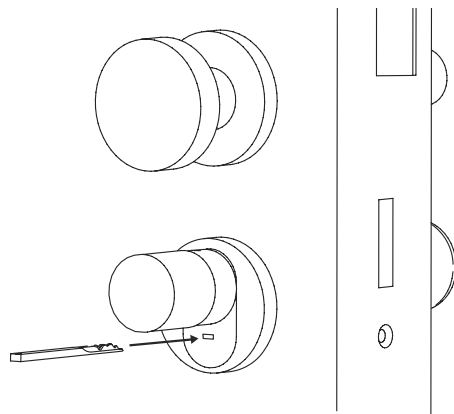

Fig. 11

! Attention: Please note, the emergency lock is designed for emergency openings only. Please do not use it as a permanent alternative to the standard locking options.

Assembly of the ENTRY easy 7600 CYL

The installation of the ENTRY easy 7600 CYL is explained below. Prior to installation, please read the installation instructions carefully.

① Remove the existing door lock cylinder by loosening the forend screw in the door and pulling out the cylinder with the key inserted (Fig. 1).

② The loosening and fixing of the outer and inner knob is achieved by means of an integrated grub screw in the rotary knob. Loosen the two grub screws in the two knobs with the enclosed hexagonal spanner (Fig. 2).

! Attention: Use the long side of the hexagonal spanner for this. Turn the screw four times anticlockwise. Do not remove the screws from the knob.

③ Pull off the knob on the outside completely and pull the knob on the inside as far back as possible (Fig. 3).

! Tip: The knob is in the inner side of the battery compartment. Pay attention to the battery compartment cover with the screw hole (see diagram).

! Attention: The knob on the inside cannot be pulled off. Do not try to loosen it by force, as pulling the knob from the shaft will destroy the electronics. The grub screw in the knob serves as a pull-off protection.

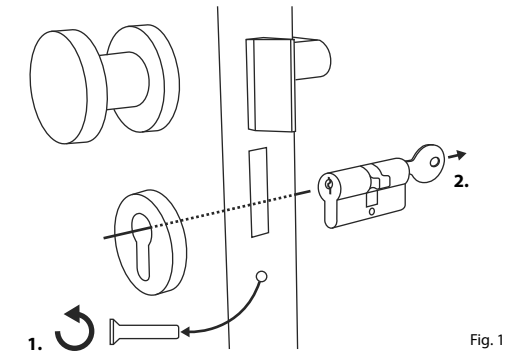

Fig. 1

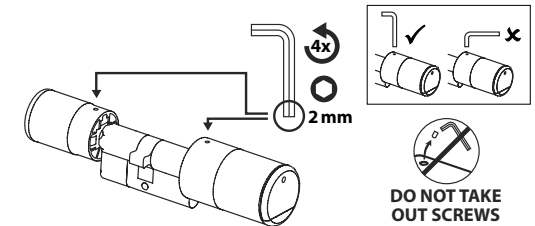

Fig. 2

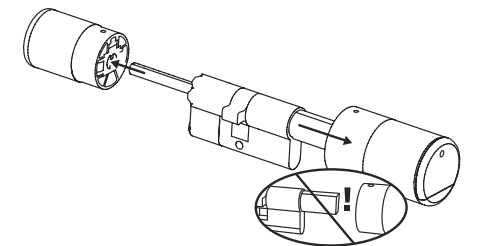

Fig. 3

- ④ Adapters may be required depending on the door thickness.

If the distance between the forend screw and the outer side of the door (Fig. 4) is...

- < 43 mm = no adapter required (Fig. 5)
- 44 - 53 mm = Adapter 1 required (Fig. 6)

Push adapter 1 onto the lock shaft and screw it tight with the two M2x10 screws provided.

- 54 - 59 mm = Adapter 1 and 2 required (Fig. 7)

After adapter 1 has been attached (see above), then also push adapter 2 onto the lock shaft. Screw it tight with the 2.9x13 screw provided.

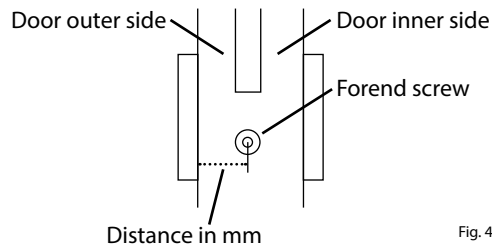

Fig. 4

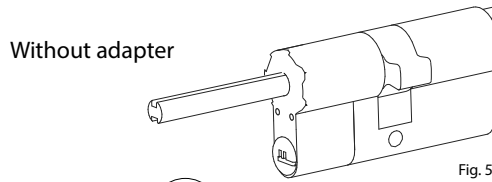

Fig. 5

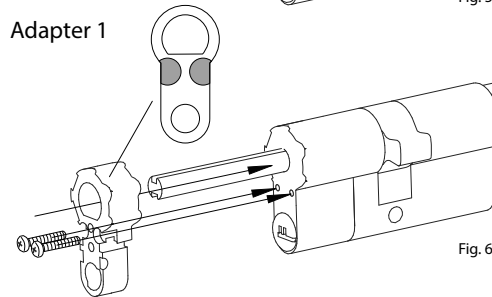

Fig. 6

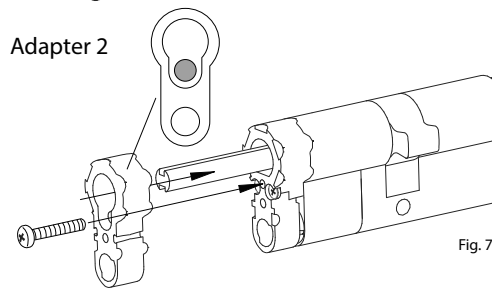

Fig. 7

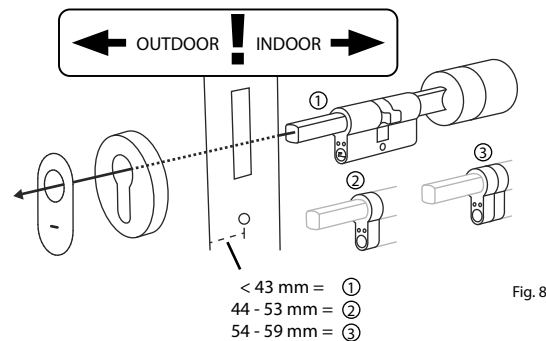

Fig. 8

- ⑥ Screw the cylinder into the door and push the inside and outside knobs up to the door (Fig. 9).

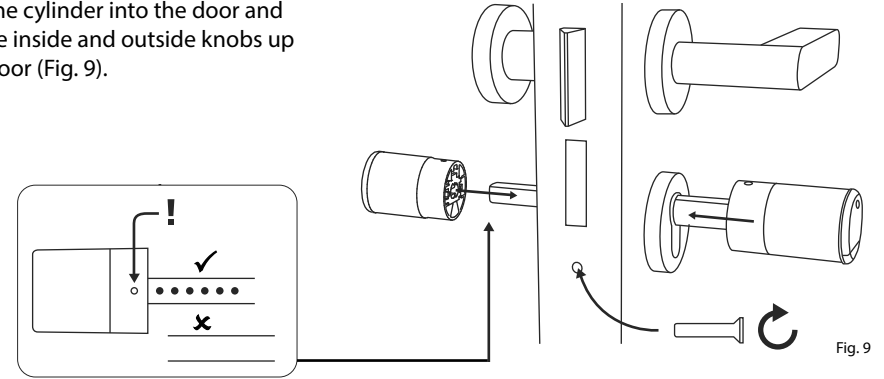

Fig. 9

- ⑦ Screw the grub screws back into the two knobs (Fig. 10).

- ! **ATTENTION:** Ensure that the knob is at least one millimetre away from the door.

Attention: Use the long side of the hexagonal spanner for this. Turn the screw clockwise with minimal force (max. torque approx. 0.4 Nm).

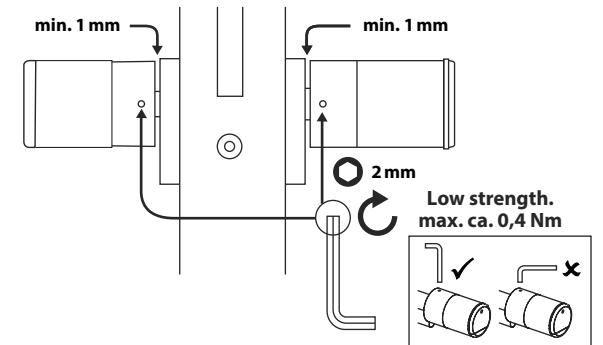

Fig. 10

- ⑧ If you have not already done so, remove the battery protection strip from the battery compartment on the inside knob (Fig. 11).

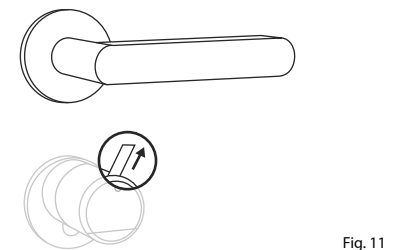

Fig. 11

ENTRY 7712 Keypad FP installation

The installation of the *ENTRY 7712 Keypad FP* is explained below.

There are two options to choose from for installation. The *ENTRY 7712 Keypad FP* wall bracket can either be **screwed** or **adhered** directly to the wall.

Prior to installation, please read the installation instructions carefully.

ENTRY 7712 Keypad FP installation - function test prior to installation

! ATTENTION:

The distance between the cylinder and the keypad can be up to a maximum of four metres. This distance may vary, however, depending on external conditions. In order to ensure that the keypad functions correctly in the desired position, we recommend testing it first **before installation**.

- ① Place the keypad in the desired installation location (Fig. 1).
 - ② Enter your administrator or user code and check that the cylinder is activated (Fig. 2).
- ! **Note:** The administrator code, if you haven't already changed it, can be found on the QR code sticker enclosed with the secuENTRY cylinder (Fig. 3). For information on how to create a user code, see the chapter "I - User" on page 4.
- ③ If the cylinder activates, the signal strength is sufficient and the keypad can be installed in the desired location. If not, try again with a shorter distance between cylinder and keypad.

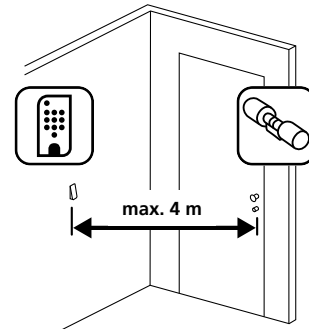

Fig. 1

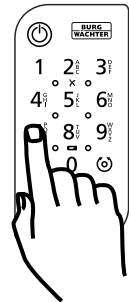

Fig. 2

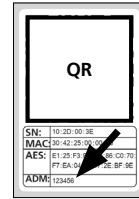

Fig. 3:
QR code sticker for
secuENTRY cylinder.
Factory-assigned
administrator code

ENTRY 7712 Keypad FP installation - screw mounting

- ① Drill three holes according to the dimensions shown in the illustration. Use a 6 mm diameter drill bit (Fig. 1).
- ② Insert the dowels supplied into the holes and screw in the screws provided (Fig. 2).

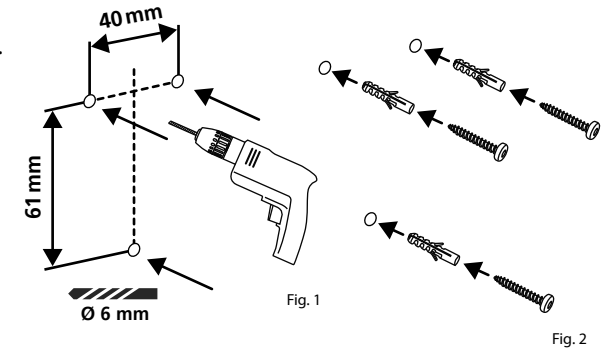

Fig. 1

Fig. 2

- ③ Remove the screw from the bottom of the keypad using the Tx8 screwdriver supplied with the keypad and pull the battery compartment downwards (Fig. 3).

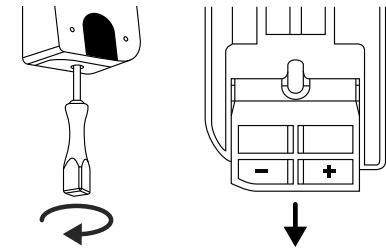

Fig. 3

- ④ Place the keypad on the screw heads as shown in the illustration (Fig. 4).

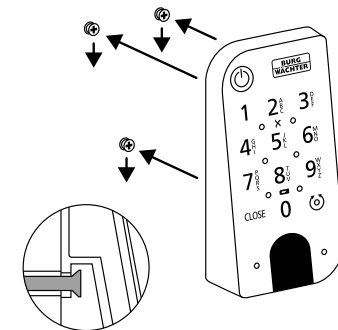

Fig. 4

- ⑤ Insert the battery compartment back into the housing and screw it tight (Fig. 5).

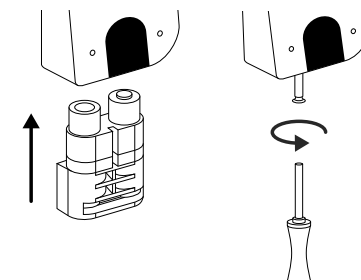

Fig. 5

ENTRY 7712 Keypad FP installation - adhesive mounting

- 1 Clean the surface to which the keypad is to be attached (Fig. 6).

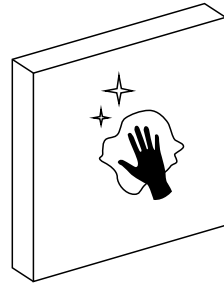

Fig. 6

- 2 Attach the enclosed adhesive pads to the positions shown in the illustration and peel off the backing strips (Fig. 7).

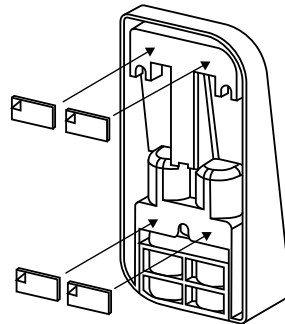

Fig. 7

- 3 Mount the keypad on the wall in the desired position (Fig. 8).

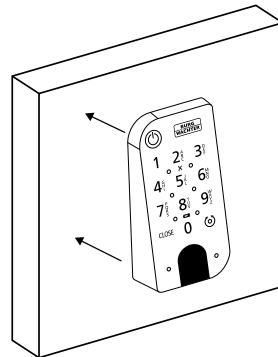

Fig. 8

- 4 Press the keypad against the wall for approx. one minute (Fig. 9).

- ! **Attention:** Only press the outer edges of the housing. To avoid damage to the electronics, do not press within the keypad area.

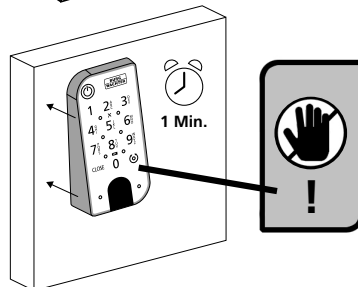

Fig. 9

Battery status display and replacing the batteries

ENTRY 7600 CYL cylinder

The battery status is shown on the display each time a secuENTRY cylinder is activated via the BURGsmart app (Fig. 1). When the batteries in the cylinder are running low, replace them as soon as possible.

- ! **Note:** The batteries are located in the cylinder knob on the **inside** of the door. If the battery status is ignored and the batteries become completely discharged, you can only open the cylinder from the outside using the emergency lock. For further information, please refer to chapter "Opening the secuENTRY lock with the emergency lock" on page 11.

Instructions on replacing the batteries are given below:

- 1 Using the TX8 screwdriver provided, loosen the screw on the inner side of the door at the front end of the knob and open the cover. The screw can only be unscrewed up to the opening of the cover and will not fall out. (Fig. 2).

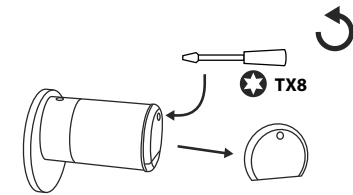

Fig. 1

- 2 Remove the old batteries and dispose of them appropriately.

- ! **Tip:** Instructions for proper disposal can be found on page 15 of these instructions.

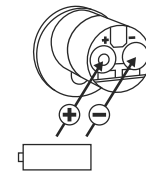

Fig. 2

- 3 Insert two new batteries. Make sure that the polarity is correct according to the drawing (Fig. 3).

- 4 Replace the front cover and screw it on tightly (Fig. 4).

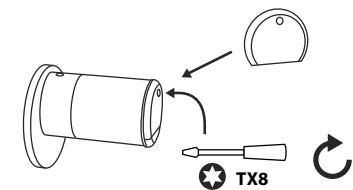
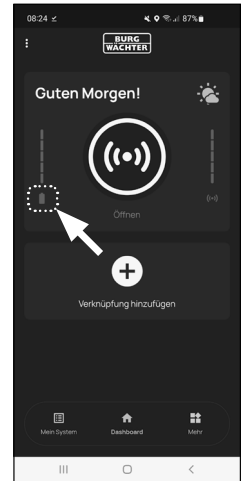

Fig. 3



ENTRY 7712 Keypad FP

The system monitors the keypad and cylinder battery voltage. The user is alerted as soon as the battery voltage reaches a critical range. Batteries must be changed as soon as possible after the battery status symbol illuminates on the keypad (Fig. 5).

Tip: It is recommended that the batteries in the cylinder and keypad are always replaced at the same time. Nonetheless, the battery status of the cylinder can be checked separately at any time. The current battery status is displayed on the BURGsmart app main screen (Fig. 6).

Instructions on replacing the batteries are given below:

① Remove the screw from the bottom of the keypad using the Tx8 screwdriver supplied (Fig. 7) with the keypad and pull the battery compartment downwards (Fig. 8).

② Remove the old batteries and dispose of them appropriately.

Tip: Instructions for proper disposal can be found on page 18 of these instructions.

③ Insert two new batteries. Make sure that the polarity is correct according to the drawing (Fig. 9).

Insert the battery compartment back into the housing and screw it tight (Fig. 10).

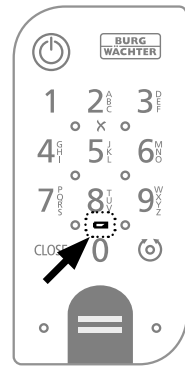

Fig. 5

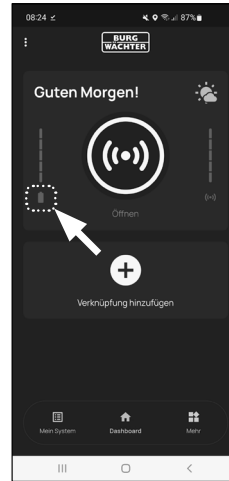

Fig. 6

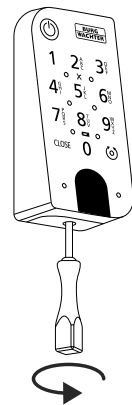

Fig. 7

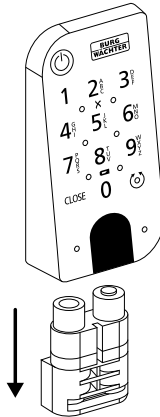

Fig. 8

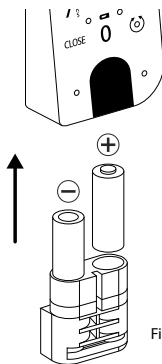

Fig. 9

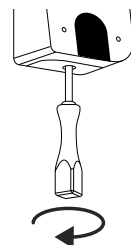

Fig. 10

Compatibility with other secuENTRY products

Whether for one front door, several doors or a complete locking system: Simply configure your individual unit with the secuENTRY modular system.

Your ENTRY 7600 CYL cylinder can be extended with the following components:

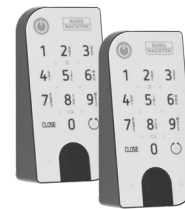

Fig. 1

secuENTRY Keypad ENTRY 7711 PIN / 7712 FP

Using the ENTRY 7711 Keypad PIN, you can unlock and lock the door with a 6-digit user code. In addition, with the ENTRY 7712 Keypad FP also with fingerprint.

A keypad ENTRY 7712 Keypad FP is already included in this ENTRY 7602 FP set.

ENTRY 7711 PIN:
4003482507117
Further information
can be found on
our website:



ENTRY 7712 FP:
4003482507124
Further information
can be found on
our website:



Fig. 2

secuENTRY Keypad ENTRY 7722 FP

The ENTRY 7722 FP display keypad enables opening with a 6-digit user code or fingerprint.

ENTRY 7722 FP:
4003482507223
Further information
can be found on
our website:



Fig. 3

secuENTRY Radio key ENTRY sE-Key 7713

The cylinder is opened simply by pressing a button using the ENTRY sE-Key 7713 radio key. The transmission is encrypted at a high security level (AES encryption).

Article number:
4003482507131
Further information
can be found on
our website:



Fig. 4

secuENTRY Transponder ENTRY 7710 RFID

The modern passive transponder provides door opening with contactless data transmission. **Attention:** The ENTRY 7174 RFID Extender add-on is additionally required for use with the ENTRY 7600 CYL cylinder.

Article number:
4003482568200
Further information
can be found on
our website:





Fig. 5

**secuENTRY Add-on
ENTRY 7174 RFID-Extender**

RFID transponder reader. Can be used for cylinders or, in conjunction with an ENTRY 7171 Relay, for external electronic devices.

▶ **Article number:**
4003482501740

▶ **Further information can be found on our website:**



www.burg.biz



Fig. 6

**secuENTRY Add-on
ENTRY 7171 Relay**

Control unit for switching external electronic devices (shutters, barriers, light sources, etc.).

▶ **Article number:**
4003482506707

▶ **Further information can be found on our website:**



www.burg.biz



Fig. 7

**secuENTRY Add-on
ENTRY 5670 Bridge**

Your new found freedom: Using the secuENTRY Bridge via the internet you can open your door even when you are out and about.

▶ **Article number:**
4003482562802

▶ **Further information can be found on our website:**



www.burg.biz



Fig. 8

**secuENTRY Add-on
ENTRY 7172 REMOTE**

For automatic remote activation. Control of electronic garage motors, alarm systems, etc.

▶ **Article number:**
4003482501726

▶ **Further information can be found on our website:**



www.burg.biz



Fig. 9

**secuENTRY Windows-Software
ENTRY 7750 Software Light**

Provides convenient user management of up to 15 users and 8 locks.

▶ **Article number:**
4003482507506

▶ **Further information can be found on our website:**



www.burg.biz



Fig. 10

**secuENTRY Windows-Software
ENTRY 7783 Software Pro**

Designed specifically for companies and public authorities. Allowing the management of up to 2,000 users and up to 1,000 doors per client (database) or up to 500 doors in hotel mode.

▶ **Article number:**
4003482507834

▶ **Further information can be found on our website:**



www.burg.biz

Warranty

In order to deliver a flawless and high quality product to you and to better assist you in case of service or repair, it is necessary that faulty or defective devices along with the valid administrator code and the QR code(s) be presented to your dealer together with the original documentation.

When returning goods due to your right of withdrawal, all parts of the appliance must also be in their factory settings. Failure to comply with this will invalidate the warranty.

Disposal of the device

Dear customer,

Please help to reduce waste. Should you intend to dispose of this device at any time, please remember that many components of this device contain valuable materials that can be recycled.



Please note that electrical and electronic devices as well as batteries must not be disposed of with household waste but rather apart from it or separately. Please obtain information on the collecting points for electrical waste from the responsible authority of your city/municipality.



BURG-WÄCHTER KG hereby declares that this device complies with the Directives 2014/53/EU, (RED) and 2011/65/EU (RoHS).

The complete text of the EU Declaration of Conformity is available at the following Internet address <https://burg.biz/pages/eu-konformitaetserklaerung>.

Printing and typesetting errors as well as technical changes reserved.



secuENTRY easy
ENTRY 7602 FP

BURG-WÄCHTER KG
Altenhofer Weg 15
58300 Wetter
Germany
www.burg.biz

BD Initial setup ENTRY easy 7602 FP EN HBG/SWI 040723

www.burg.biz