



secu **ENTRY** home

Initial setup

secuENTRY home

ENTRY 5000 CYL

en



Setup with app
BURGsmart



BURG-WÄCHTER KG
Altenhofer Weg 15
58300 Wetter
Germany



Video instructions

Simple instructions on the setup and operation of your secuENTRY components. Follow the QR code or go to...

<https://t1p.de/burgsmart-app>

www.burg.biz

Contents index

en English 2

Further languages at:

www.burg.biz

Foreword

Dear Customer,

Thank you very much for deciding on the secuENTRY cylinder ENTRY home 5000 CYL.

The system was developed in Germany according to the most modern technical capabilities and fulfils the latest high safety requirements.

The ENTRY home 5000 CYL electronic cylinder can be easily installed in any door with a mortise lock, up to a door thickness of 118 mm (59/59 mm, measured in the centre of the forend screw). No drilling or laying of cables is required and it is ideally suited for both new installations and retrofitting. The ENTRY home 5000 CYL can be fitted to house and interior doors.

The ENTRY home 5000 CYL is setup and operated using the free smartphone app *BURGsmart*^{*}. The transmission is wireless, the cylinder and keypad both use the modern Bluetooth 5.2 standard.

^{*} Alternatively, the cylinder can also be operated via keypad *ENTRY 7711 PIN* and the radio key *ENTRY sE-Key 7713* (available separately). The *BURGsmart* app is however always required for the setup.

! Important:

- Please read the entire operating instructions before you start the installation.

We hope you enjoy your new locking system!

Set contents

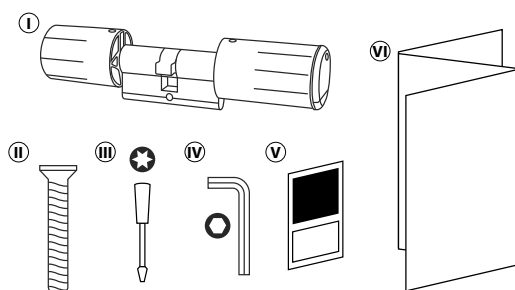

Fig. 1

① Cylinder ENTRY home 5000 CYL
② Forend screw
③ Screwdriver Tx8
④ Hexagon spanner SW2
⑤ QR-Code sticker
⑥ Quick Start Guide plus warranty and disposal instructions

QR code/Administrator code

The QR codes (I) are required later when setting up the set using the BURG-WÄCHTER BURGsmart app (Fig. 1).

The sets are delivered from the factory with a random administrator code (II) (Fig. 1), consequently a code change is not mandatory.

- ! Attention:**
- Neither the QR codes nor the factory-generated administrator code are stored by BURG-WÄCHTER. Recovery is not possible if the codes are lost. It is important to keep the QR code stickers enclosed with the set in a safe place. We further recommend that you photograph the stickers and also archive them digitally.

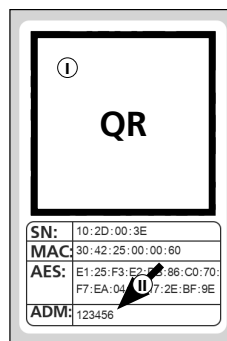

Cylinder QR code sticker

Fig. 1

Technical details - ENTRY 5000 home CYL Cylinder

Cylinder unit power supply	2x Mignon LR6 AA alkaline
Permitted ambient conditions	-15 °C/+50 °C / up to 95 % relative air humidity (non-condensing)
Radio standard	Bluetooth 5.2 LE
Transmission power	≤ 10 dBm
Frequency range	2.4 - 2.483 GHz
Range	Approx. 4 m
Number of access media	1 Code (Administrator)* + 5 sE-Keys** or 5 BURGsmart connections

! Note:

- The integrated manipulation protection in the cylinder ensures that the cylinder is blocked for one minute after three incorrect entries of an opening media. From the fourth incorrect entry, the cylinder is blocked for three minutes each time.

* Per keypad ENTRY 7711 Keypad PIN (available separately).

** Radio key ENTRY sE-Key 7713 available as an option.

ENTRY home 5000 CYL activation

- 1 First of all, download the *BURGS*mart app in order to be able to set up your new locking system. This can be found in the iOS App Store and at Google Play (Fig. 1).



Fig. 1

- ! **Note:** The Android version of the *BURGS*mart app has been used for these instructions. The iOS version can be slightly different visually, but the work steps are identical.

- 2 You will be shown licence provisions for the use of the app when you open it for the first time. Carefully read them and then confirm by clicking "OK" in the bottom right-hand corner (Fig. 2).
- 3 Enter your name and a mail address (Fig. 3).
- 4 Select them the item: "*BURG-WÄCHTER Cloud*" this is not required for the setup and can therefore be ignored for the time being (Fig. 3). An explanatory note on this subject can be found in the master operating instructions on our website (see link on the title page).
- 5 Read through and agree to the terms of use and privacy policy (Fig. 3).
- 6 Tap on "Register" (Fig. 3).
- 7 The *BURGS*mart app main screen appears. Open the "My System" menu at the bottom left (Fig. 4).



Fig. 2

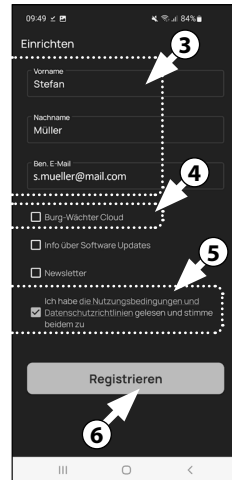

Fig. 3

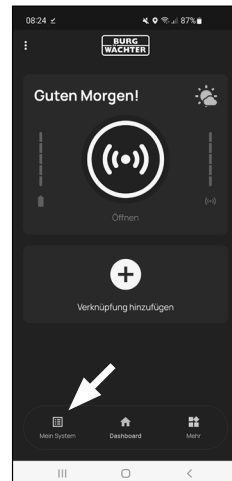

Fig. 4

I - User

- 1 Tap on the menu item "I - User" (Fig. 1).
- 2 A list of the users that have already been created is displayed. A user profile with a lock opening via smartphone has already been automatically created for the administrator. Tap on this (I) (Fig. 2).

- ! **Note:** Alternatively, a new additional user profile can be created at this point. To do so, tap the "+" in the top right-hand corner (II) (Fig. 2).

User data

- 3 An overview of the user data appears. If you have created a new user, first enter the first name and surname of the user (I) (Fig. 3).

Access data

This section allows the user to enter the desired opening media (II) (Fig. 3). The lock opening by smartphone is automatically stored in the administrator's user profile (III) (Fig. 3).

- ! **Attention:** No user code other than the administrator code can be stored with this *ENTRY 5000 CYL*. It is also not possible to store an RFID tag or fingerprint.

There is the option of setting up to 5 sE-Key radio keys (available separately) and additional smartphones as electronic keys for additional users. Follow the instructions in the next steps. Furthermore, with the optional *ENTRY 7711 PIN keypad*, you have the option to open the door lock with your administrator code. For the respective setup, follow the instructions in the next steps.

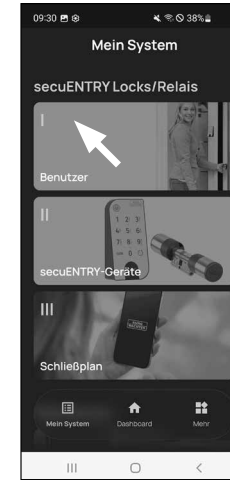

Fig. 1

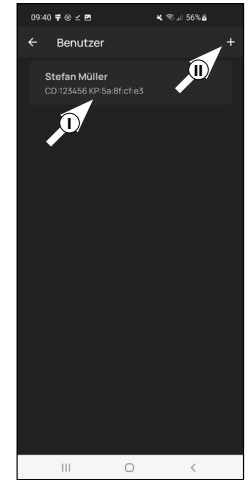

Fig. 2

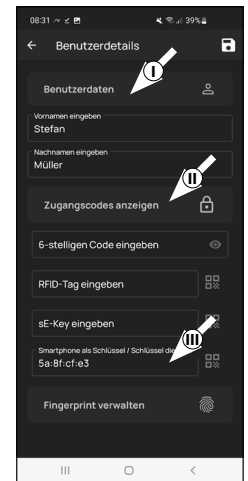

Fig. 3

- 5 The capture window of the camera opens. Scan the QR code.
- 6 A message appears containing data regarding your cylinder; confirm this with "OK" at the bottom right (Fig. 5).
- 7 In the following window, you will be prompted to assign a name for the cylinder. Where several cylinders and secuENTRY components are used, it is recommended to name the cylinder in such a way that you can directly identify what it is and where the cylinder is located or attached. In the example in these instructions, the cylinder is titled "Front door cylinder". Confirm the name with "OK" (Fig. 6).
- 8 A message appears informing you that you can change your administrator code. As you received a randomly generated administrator code at the time of delivery, this step is optional. You can bypass this with "Skip" (Fig. 7).

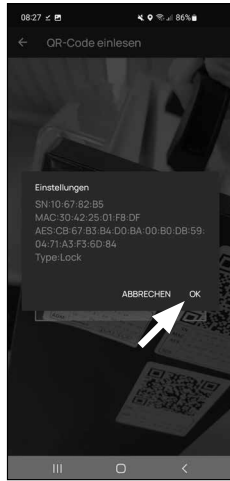

Fig. 5

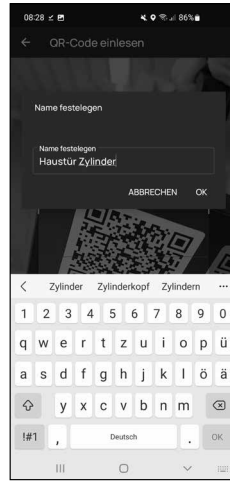

Fig. 6



Fig. 7

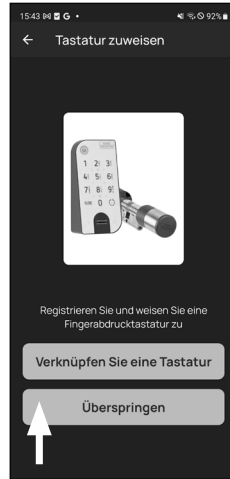

Fig. 8

! Note: The randomly generated administrator code can be found on the enclosed QR code sticker under "ADM" (Fig. 9). The administrator code can be changed at any time at a later date. Refer to the master operating instructions on our website for an explanation on this subject (see link on the title page).

- 9 In order for the keypad to receive the information on which cylinder it is to control, this cylinder must be available and assigned within the app.

The next menu (Fig. 8) offers you the following two options:

- „Link to an keypad“: You have already setup a keypad in the app and want to link it again.
- „Skip“: Carry out this step at a later date.

! Note: The ENTRY 5000 CYL cylinder does not contain a keyboard. If you do not have a keypad, you can skip this menu item and proceed directly to the next chapter.

- 10 Tap on „Skip“ (Fig. 8).

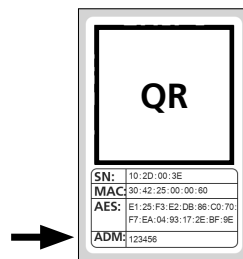

Fig. 9
Cylinder QR code sticker

III - Locking plan

- 1 Use this menu to define the locking plan, namely which user is allowed to open which lock. The data is then transferred to the cylinder.
- 2 Open the "My System" menu (I) (Fig. 1).
- 3 Tap on the fourth menu item "III - Locking plan" (Fig. 1).
- 4 A table is displayed consisting of the existing cylinders (horizontal) and the configured users (vertical) (Fig. 2). Select the checkbox where you wish to authorise the respective user to use the corresponding lock (I) (Fig. 2) and then click on the button „Save changes“ (II) (Fig. 2).

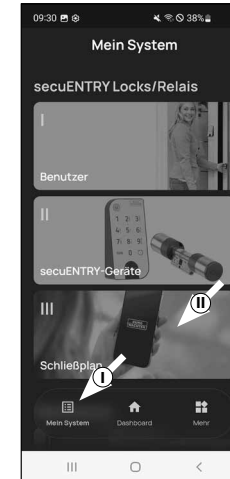

Fig. 1

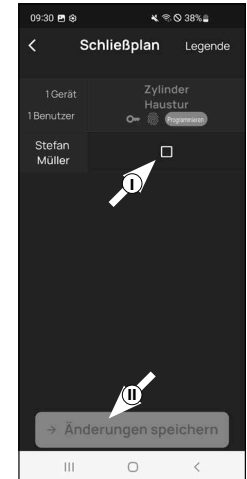

Fig. 2

! For info: This table is of interest when you have several cylinders and users. This allows you to clearly determine in one step who is allowed to access which cylinder. Fig. 3 provides an example of what a completed table with corresponding cylinders and users might look like.

! Attention: The following step requires the smartphone, keypad and cylinder to be in direct proximity to each other (Bluetooth range).

- 5 If any changes have been made to the locking plan, the display of the respective cylinder appears red and the „Program“ button is displayed. This indicates that the settings have not yet been transferred to the cylinder. To do this, tap the red „Program“ button for the respective cylinder (Fig. 4).

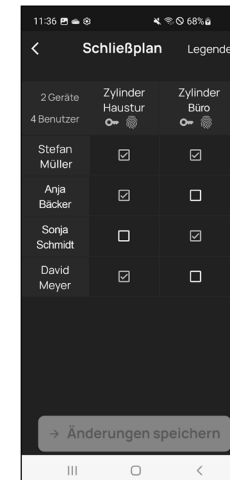

Fig. 3

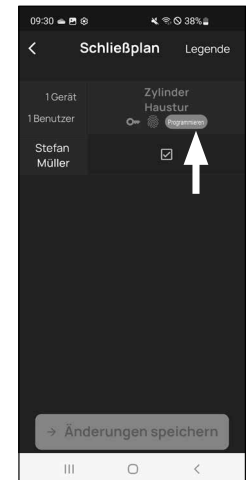

Fig. 4

⑥ Here you will be asked to verify yourself with your administrator code. Enter the code and confirm with "OK" (Fig. 5).

! **Note:** The factory administrator code can be found on the QR code sticker of the cylinder under "ADM" (Fig. 9).

⑦ The data will be transferred. A confirmation will appear after a brief moment and at the same time a request to now assign the keypad. Tap on the confirmation message (Fig. 6).

⑧ Select the required keypad (Fig. 7).

⑨ You will be asked to set the keypad to programming mode (Fig. 8). Instructions on how to do this can be found in the chapter "Setting the keypad into programming mode" on page 3. As soon as the keypad is in programming mode, indicated by the LEDs on the keypad flashing continuously, tap the "LEDs flashing continuously, continue" key in the app (Fig. 8).

⑩ A confirmation will appear after a brief moment when the data has been transferred. Confirm with "OK".

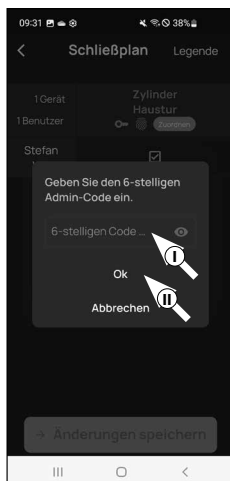

Fig. 5

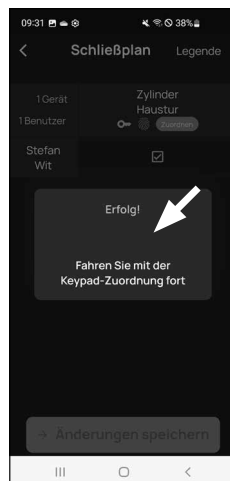

Fig. 6

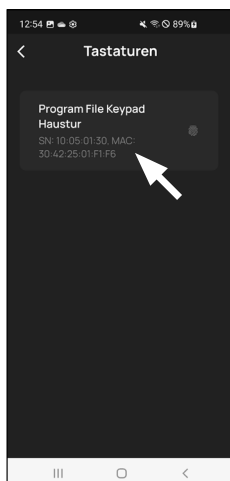

Fig. 7



Fig. 8

The setup is now completed.

Repeat the steps in the respective chapters if you wish to integrate further components into your system at a later date, change access data or create additional users.

Please note: All changes and additions are carried out within the app and must then be transferred to the respective secuENTRY component. This last chapter, "Locking plan" (page 8) must be completed in each case in order to be able to use them in your components.

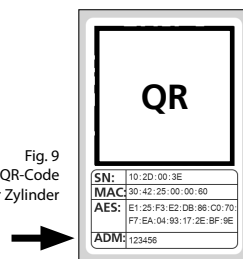

Fig. 9
QR-Code
Aufkleber Zylinder

Using the cylinder and keypad

To use the cylinder (Fig. 1) remove the battery protection strip.

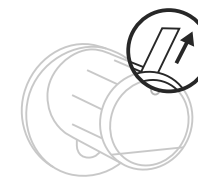

Fig. 1

Opening the secuENTRY lock

The ENTRY home 5000 CYL enables you to open the lock via the BURGsmart app, provided you have set up the corresponding opening media in accordance with these instructions.

Opening the secuENTRY lock with the BURGsmart app

Proceed as follows to open the ENTRY home 5000 CYL cylinder and consequently also the door:

① Open the BURGsmart app and press the "ACCESS" button in the middle (Fig. 1).

! **Note:** The BURGsmart app is programmed so that when more than one cylinder is used, it automatically adjusts to the cylinder that is within the shortest distance of the smartphone. Each cylinder can be opened by pressing the "ACCESS" button.

② The cylinder is now released and the lock can be opened (Fig. 2) or locked (Fig. 3).

! **Note:** Depending on the door stopper, the direction of rotation may be reversed.

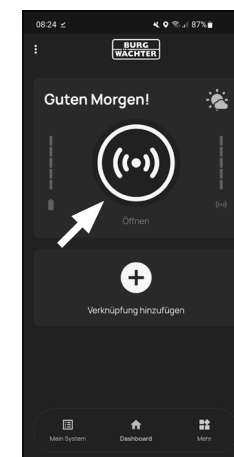

Fig. 1

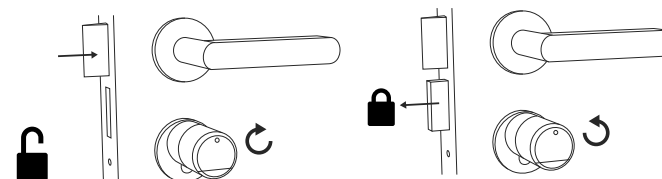

Fig. 2

Fig. 3

secuENTRY 5000 CYL installation

The installation of the secuENTRY 5000 CYL is explained below. Prior to installation, please read the assembly instructions carefully.

- 1 Remove the existing door lock cylinder by loosening the forend screw in the door and pulling out the cylinder with the key inserted (Fig. 1).

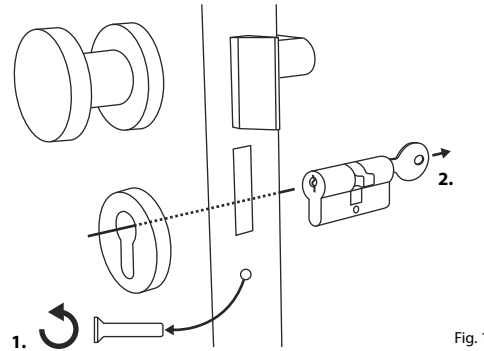

Fig. 1

- 2 The loosening and fixing of the outer and inner knob is achieved by means of an integrated grub screw in the rotary knob. Loosen the two grub screws in the two knobs with the enclosed hexagonal spanner (Fig. 2).

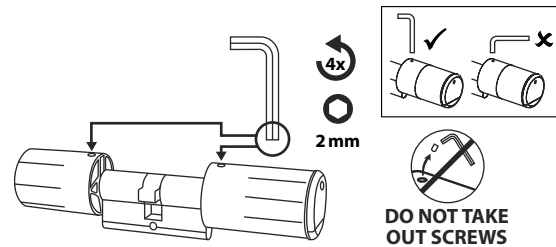

Fig. 2

- ! **Attention:** Use the long side of the hexagonal spanner for this. Turn the screw four times anticlockwise. Do not remove the screws from the knob.

- 3 Pull off the knob on the outer side completely and pull the knob on the inner side as far back as possible (Fig. 3).

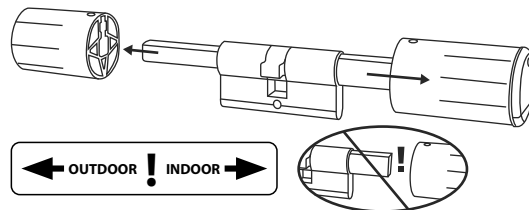

Fig. 3

- ! **Tip:** The knob on the inner side is larger than the knob on the outside.

- ! **Attention:** The knob on the inner side cannot be pulled off. Do not try to loosen it by force, as pulling the knob from the shaft will destroy the electronics. The grub screw in the knob serves as a pull-off protection.

- 4 From inner side the door, push the cylinder into the mortise lock (Fig. 4).

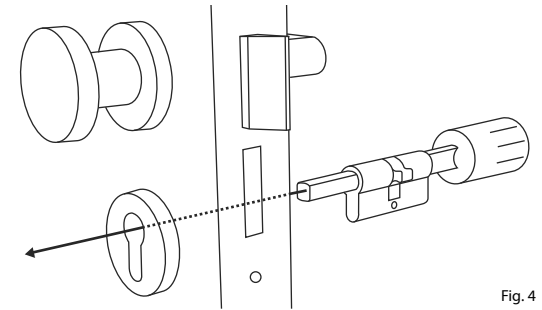

Fig. 4

- 5 Screw the cylinder into the door and push the inside and outside knobs up to the door (Fig. 5).

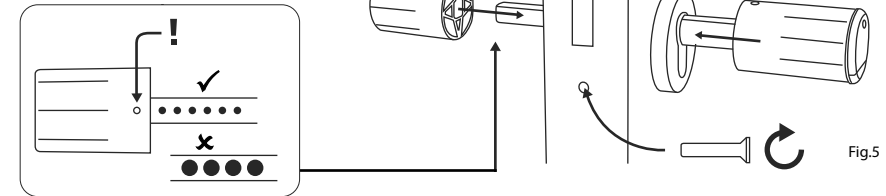

Fig. 5

- 6 Screw the grub screws back into the two knobs (Fig. 6).

- ! **Attention:** Ensure that the knob is at least one millimetre away from the door.

- ! **Attention:** Use the long side of the hexagonal spanner for this. Turn the screw in a clockwise direction with minimal force (max. torque approx. 0.4 Nm).

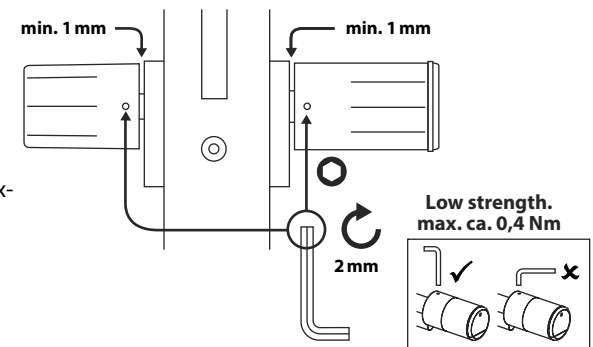

Fig. 6

- 7 If you have not already done so, remove the battery protection strip from the battery compartment on the inside knob (Fig. 7).

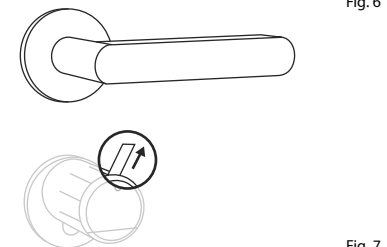

Fig. 7

Battery status display and replacing the batteries

Cylinder *ENTRY home 5000 CYL*

The battery status is shown on the display each time a secuENTRY cylinder is activated via the BURGsmart app (Fig. 1). When the batteries in the cylinder are running low, replace them as soon as possible.

! Attention: The batteries are located in the cylinder knob on the **inner side** of the door. Please note that if you ignore the battery status and the battery is completely discharged, **you will no longer be able to open the lock from the outside.**

Instructions on replacing the batteries are given below:



Fig. 1

- 1 Using the TX8 screwdriver provided, loosen the screw on the inner side of the door at the front end of the knob and open the cover. The screw can only be unscrewed up to the opening of the cover and will not fall out. (Fig. 2).

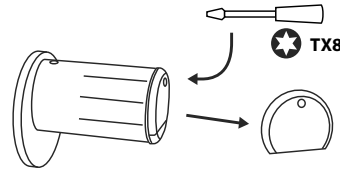

Fig. 2

- 2 Remove the old batteries and dispose of them appropriately.

! Tip: Instructions for proper disposal can be found on page 8 of these instructions.

- 3 Insert two new batteries. Make sure that the polarity is correct according to the drawing (Fig. 3).

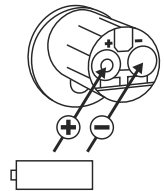

Fig. 3

- 4 Replace the front cover and screw it on tightly (Fig. 4).

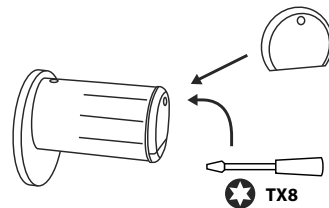

Fig. 4

Compatibility with other secuENTRY products

Whether for one front door, several doors or a complete locking system: Simply configure your individual unit with the secuENTRY modular system.

Your *ENTRY home 5000 CYL* locking system can be extended with the following components:

secuENTRY ENTRY sE-Key 7713



Fig. 1

The cylinder is opened simply by pressing a button using the *ENTRY sE-Key 7713* radio key. The transmission is encrypted at a high security level (AES encryption).

Article number:
4003482507131
**Further information
can be found on
our website:**



www.burg.biz

secuENTRY Keypad ENTRY 7711 PIN



Fig. 2

Using the *ENTRY 7711 Keypad PIN*, you can unlock and lock the door with the 6-digit administrator code.

Article number:
4003482507117
**Further information
can be found on
our website:**



www.burg.biz



secuENTRY home
ENTRY 5000 CYL

BURG-WÄCHTER KG
Altenhofer Weg 15
58300 Wetter
Germany
www.burg.biz

BD initial setup secuENTRY home ENTRY 5000 CYL EN HBG/SWI 210923

www.burg.biz