



**BURG  
WÄCHTER**

## OPERATING INSTRUCTIONS

Ultra HD (e)PoE Network Video Recorder

**Models:**  
BWNVR-2411P  
BWNVR-31632Pi  
SNVR-3842e  
SNVR-31642e  
SNVR-36444e





Dear Customer,

Thank you for choosing a BURG-GUARD quality product.

Please read these operating instructions carefully before using the unit for the first time and be sure to follow all the instructions described here.

If you have any questions about commissioning or if you would like to make use of a warranty or service, please contact your specialist dealer or contact us.

Additional information can also be found on our website:

[www.burg-guard.com](http://www.burg-guard.com)

**Imprint:**

The copyright of these operating instructions is the exclusive property of BURG-GUARD GMBH.

Any reproduction, including on electronic data carriers, requires the written consent of BURG-GUARD GMBH. Reprinting - even of extracts - is prohibited.

Errors and technical modifications excepted.

BURG-GUARD is a registered trademark of BURG-GUARD GMBH. Other company and product names that may be mentioned are trademarks or registered trademarks or brands of the respective owners.

© Copyright by: BURG-GUARD GMBH  
Wormgermühle  
58540 Meinerzhagen  
Germany  
[www.burg-guard.com](http://www.burg-guard.com)



## Table of contents

About this manual .....	6
1. General.....	7
Spare parts and accessories .....	10
2. Controls, displays and connections .....	11
2.1 Front view.....	11
2.2 Connections on the rear of the unit.....	13
2.2.1 BWNVR-2411P.....	13
2.2.2 SNVR-3842P(e).....	13
2.2.3 SNVR-31642e .....	14
2.2.4 BWNVR-31632Pi.....	14
2.2.3 SNVR-36444e .....	15
2.2.4 Alarm input and output.....	16
2.2.4.1 Alarm input.....	16
2.2.4.2 Alarm output.....	17
3. Local commissioning.....	18
3.1 Login.....	18
3.2 Calling up the main menu.....	19
3.3 Changing the menu language .....	19
3.4 Logout and switch off recorder .....	19
3.5 Note on cameras.....	20
3.6 Note on the first operation of BURG-GUARD cameras on the PoE port.....	20
4. Operating the recorder .....	21
4.1 Operating the recorder with the mouse.....	21
4.2 Operating the Recorder with the IR Remote Control .....	22
5. Functional description .....	23
5.1 Live view.....	23
5.1.1 Event Display.....	23
5.1.2 Calling up the menu bar .....	23
5.2 Access to the quick menu via right mouse button .....	25
5.2.1 View(s).....	25
5.2.2 PTZ control .....	26
5.2.3 Fisheye.....	30
5.2.4 Auto Focus.....	31
5.2.5 Camera.....	32
5.2.6 Search .....	32
5.2.7 Manual.....	32
5.2.8 Camera Settings .....	33
5.2.9 Main menu.....	33
5.3 Calling up the navigation bar .....	34
5.4 USB Auto Pop-up.....	35
6. Settings via the main menu .....	36
6.1 Main menu→ Live .....	37
Navigation bar.....	38
6.2 Main menu→ Playback View .....	40
6.2.1 Main menu→ Playback Bookmark .....	43
6.2.2 Main menu→ Playback Bookmark→ Set marker .....	43
6.2.3 Main menu→ Playback Bookmark→ Search marker .....	44
6.2.4 Main menu→ Playback Bookmark→ Edit/remove marker .....	45

6.3	Main menu→ AIVA.....	46
6.3.1	Main menu→ AIVA→ Intelligent search.....	46
6.3.1.1	Face recognition.....	46
6.3.1.2	Face recognition.....	47
6.3.1.3	IVA / AIVA.....	48
6.3.1.4	Person recognition.....	49
6.3.1.5	Vehicle detection.....	50
6.3.1.6	Non-motorised vehicles.....	51
6.3.1.7	Census of persons.....	52
6.3.1.8	Heatmap.....	52
6.3.2	Main menu→ AIVA→ Parameters (Camera Remote Setup).....	52
6.3.2.1	IVA Plan.....	53
6.3.2.2	Face recognition.....	54
6.3.2.3	Face recognition.....	55
6.3.2.4	IVA.....	56
6.3.2.5	AI/KI VA.....	59
6.3.2.6	People counting / queue.....	60
6.3.2.7	Heatmap.....	61
6.3.2.8	Vehicle number plate recognition.....	63
6.4	Main menu→ Alarm(s).....	65
6.4.1	Main menu→ Alarm(s)→ Alarm Info.....	65
6.4.2	Main menu→ Alarm(s)→ Alarm.....	66
6.4.3	Main menu→ Alarm(s)→ Alarm input.....	66
6.4.4	Main menu→ Alarm(s)→ Alarm output.....	68
6.4.5	Main menu→ Alarm(s)→ Motion detection.....	69
6.4.5.1	Main menu→ Alarm(s)→ Motion detection Motion→.....	69
6.4.5.2	Main menu→ Alarm(s)→ Motion detection→ Video loss.....	70
6.4.5.3	Main menu→ Alarm(s)→ Motion detection→ Sabotage.....	70
6.4.5.4	Main menu→ Alarm(s)→ Motion detection→ Scenes Change.....	71
6.4.5.5	Main menu→ Alarm(s)→ Motion detection→ PIR alarm.....	71
6.4.5.6	Main menu→ Alarm(s)→ Audio Analysis.....	72
6.4.5.7	Main menu→ Alarm(s)→ Thermal image AI Alarms.....	72
6.4.5.8	Main menu→ Alarm(s)→ Abnormality→ HDD.....	73
6.4.5.9	Main menu→ Alarm(s)→ Abnormality→ Network.....	73
6.4.5.10	Main menu→ Alarm(s)→ Abnormality→ User.....	74
6.4.5.11	Main menu→ Alarm(s)→ Anomaly→ Device.....	74
6.5	Main menu→ POS (Point of Service).....	75
6.5.1	Main menu→ POS (Point of Service)→ POS Search.....	75
6.5.2	Main menu→ POS (Point of Service)→ POS Setup.....	75
6.6	Main menu→ Application.....	76
6.6.1	Main menu→ Application→ Log.....	76
6.6.2	Main menu→ Application→ Information.....	76
6.6.3	Main menu→ Application→ Network.....	78
6.6.4	Main menu→ Application→ Network Load.....	79
6.6.5	Main menu→ Application→ Network Test.....	79
6.6.6	Main menu→ Application→ System maintenance.....	80
6.7	Main menu→ Application→ Backup.....	82
6.8	Main menu→ Display.....	84
6.8.1	Main menu→ Display→ Display.....	84
6.8.2	Main menu→ Display→ Tour.....	85
6.8.3	Main menu→ Display→ User-defined display.....	86
6.9	Main menu→ Audio.....	87
6.9.1	Main menu→ Audio→ File manager.....	87
6.9.2	Main menu→ Audio→ Schedule.....	87
6.9.3	Main menu→ Audio→ Broadcast.....	88
6.10	Main menu→ Log off / Shut down.....	89
6.11	Main menu→ Administration→ Camera.....	90
6.11.1	Main menu→ Administration→ Camera→ Integrate devices.....	90



6.11.2	Main menu→ Administration→ Camera→ Image settings	93
6.11.3	Main menu→ Administration→ Camera→ Overlay	94
6.11.4	Main menu→ Administration→ Camera→ Audio/video	94
6.11.5	Main menu→ Administration→ Camera→ Camera name	95
6.11.6	Main menu→ Administration→ Camera→ PoE	96
6.11.7	Main menu→ Administration→ Camera→ PTZ Setup	97
6.12	Main menu→ Administration→ Network	97
6.12.1	Main menu→ Administration→ Network→ TCP/IP	98
6.12.2	Main menu→ Administration→ Network→ Port Setup	99
6.12.3	Main menu→ Administration→ Network→ 3G/4G	100
6.12.4	Main menu→ Administration→ Network→ PPPoE	101
6.12.5	Main menu→ Administration→ Network→ DDNS	102
6.12.6	Main menu→ Administration→ Network→ UPnP	104
6.12.7	Main menu→ Administration→ Network→ E-mail	105
6.12.8	Main menu→ Administration→ Network→ FTP setting	106
6.12.9	Main menu→ Administration→ Network→ SNMP	107
6.12.16	Main menu→ Administration→ Network→ 802.1x	113
6.12.17	Main menu→ Administration→ Network→ IP Filter	114
6.13	Main menu→ Administration→ Memory	115
6.13.1	Main menu→ Administration→ Memory→ Memory General	115
6.13.2	Main menu→ Administration→ Memory→ Schedule	116
6.13.3	Main menu→ Administration→ Storage→ HDD Manager	118
6.13.4	Main menu→ Administration→ Memory→ HDD (hard disk)	119
6.13.5	Main menu→ Administration→ Memory→ Recording	119
6.13.6	Main menu→ Administration→ Memory→ HDD Detected	120
6.13.7	Main menu→ Administration→ Memory→ Recording Estimation	121
6.13.8	Main menu→ Administration→ Storage→ FTP	122
6.14	Main menu→ Administration→ System	123
6.14.1	Main menu→ Administration→ System→ General settings	123
6.14.2	Main menu→ Administration→ System→ RS232	126
6.14.3	Main menu→ Administration→ System→ Security	127
7.	Network access	131
7.1	Remote Access: Accessing the Recorder via the Web	131
7.1.1	Establishing a network connection	131
7.1.2	Login via the web	131
7.1.3	Finding a device in the network	131
7.1.4	Manual entry of the IP address via the web browser:	132
7.1.5	Login	133
7.1.6	Security	134
7.1.6.1	System services	135
7.1.6.2	Attack defence	137
7.1.6.3	CA Certificate	139
7.1.6.4	Audio/Video Encryption	141
7.1.6.5	Safety warning	141
8.	Remote connections	142
8.1	BURGcam App - P2P	142



## About this manual

This manual is intended to assist in the use of the recorders described. These operating instructions are subject to strict quality control. However, no guarantee can be given that it does not contain errors. Changes may be made to the operating instructions without prior notice.

Note: Different firmware versions can, among other things, lead to deviating menu structures or operation and to altered function sequences compared to the manual or the previous version.

Before using this recorder, read this manual carefully. Keep this manual in a safe place for future use. Check that all the components of the recorder have been supplied. If any components are missing, do not operate the recorder and contact your dealer. Do not attempt to repair a defective recorder yourself; only have repairs carried out by qualified personnel!

**Improper handling of the appliance will invalidate any warranty claim.**

## 1. General

Please read this manual carefully before operating the unit and keep it as a reference book for later.

### Safety instructions and precautions



#### Ingress of liquids or objects

Make sure that no moisture or objects can enter the unit.

#### Lithium battery

Caution! There is a risk of explosion if the lithium battery (RTC battery) is incorrectly connected. Replace the battery only with identical or equivalent components recommended by the manufacturer. When disposing of used batteries, follow the manufacturer's instructions.

### CE guidelines

This appliance complies with the CE directives.

If you require an EC Declaration of Conformity for this appliance, please send a request to: [URG-GUARD-support@burg.biz](mailto:URG-GUARD-support@burg.biz)

#### Caution:

Changes and modifications not expressly approved by the competent licensing authority could void the user's authority to operate the equipment.



## Cyber Security Information

BURG-WÄCHTER KG follows standard industry practice in product / software testing and dealing with any vulnerabilities found in products and product software in order to minimise the risk to customers. Unfortunately, a complete security of products, software and services, which are created and tested to the best of our knowledge and belief, cannot be completely guaranteed to be free of errors that cannot be overcome by possibly malicious attackers. This applies not only to BURG-WÄCHTER devices, but rather to the general public of networkable devices that have communication interfaces and services. BURG-WÄCHTER KG can guarantee that we will endeavour to reduce the risk to a minimum.

Vulnerability remediation is an ongoing process, as new vulnerabilities, including in network protocols and services, are always being found and cannot be completely ruled out.

If you have any questions about the product or its setup, please contact:  
[camera-service@burg.biz](mailto:camera-service@burg.biz)

## GDPR

When video security systems are used, personal data is collected, processed and used in automated form. Such data is protected by the GDPR, which is an EU regulation that applies directly in Germany.

The operator of the system is responsible for the operation and processing of the data. When installing the video security system, suitable technical and organisational measures must be taken to protect the personal rights of the persons concerned.



## Setup and installation

- On-site installation should only be carried out by qualified personnel and must comply with local specifications and regulations.
- Never operate the unit near water, in dusty rooms or rooms with extremely high humidity. The unit could otherwise be damaged.
- Openings on the unit are for ventilation and protect against overheating. These openings must never be covered or blocked. The unit may only be installed in a rack if sufficient ventilation can be ensured. Overheating can lead to damage to the unit.
- When connecting the operating voltage, ensure that the polarity is correct. Incorrect connection may result in damage to or destruction of the unit.
- Only the power source indicated on the type plate may be used. If you are not sure whether the power supply available at the installation site can be used, ask your electrical installer. Only use the enclosed cables, power supply units or adapters or the expressly recommended accessories.

## Repair and maintenance

- Before any cleaning, the appliance must be switched off and the plug removed from the mains socket. The unit may only be cleaned with a slightly damp cloth. Do not use harsh cleaning agents or spray cans. The use of harsh solvents such as thinner or petrol may damage the surface of the housing.
- In case of damage to the unit or the cables, switch off the unit immediately and disconnect it from the operating voltage without delay. Take the unit to a specialist workshop in the event of the following damage:
  - In case of damage to the power supply cable
  - if a liquid has been spilled on the unit or an object has entered the unit
  - if the unit has been exposed to water or any other liquid
  - if the unit does not work properly despite following the instructions in these operating instructions. Only the controls described in the operating instructions may be adjusted. Incorrect settings on all other controls can damage the unit.
  - if the unit has fallen to the floor or if the housing has been damaged
  - if the unit falls significantly below the required performance values
- Never attempt to carry out maintenance work yourself as you may expose yourself to dangerous voltages. Leave this maintenance work to qualified personnel.



### Attention:

Opening the housing will inevitably invalidate the warranty. Therefore, please do not carry out any work on the unit yourself, but contact your specialist dealer.

- In digital video recorders, the hard disk is essentially the component that is subject to natural wear and tear. Here too, after approx. 8,000 to 10,000 hours of operation, signs of wear and tear may appear and malfunctions may occur. We therefore recommend replacing the hard disk at regular intervals to ensure trouble-free operation. Furthermore, we recommend that the fans installed in the unit be regularly cleaned of dust and dirt in order to avoid malfunctions due to overheating etc. If you have any questions on this subject, we will be happy to help you.

**Attention: Wear of mechanical components**

We hereby expressly point out that every recording device, be it an analogue or a digital device, is subject to natural wear and tear. Every recording device contains mechanical parts that - as with any other device - must be maintained or checked regularly. This applies in particular to products that have been developed for continuous use.

**Spare parts and accessories**

- Do not use any additional devices that have not been recommended by the manufacturer of the unit. These can affect the functionality of the appliance and, in the worst case, cause injuries due to electric shock or cause a fire due to a short circuit.
- Only parts approved by the manufacturer or those with identical performance data may be used as spare parts. Unapproved spare parts may cause damage to persons (electric shock) and to the appliance (fire).

## 2. Controls, displays and connections

### 2.1 Front view

Control indicators on the front of the unit:

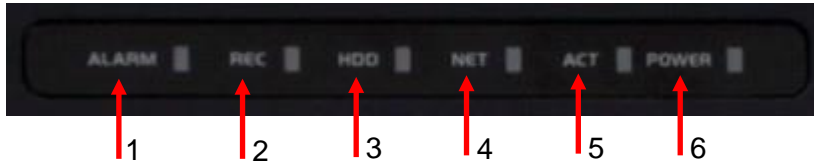

No.	Display	Description
1	ALARM	Alarm
2	REC	Recording
3	HDD	Hard disk
4	NET	Network connection
5	ACT	IR remote control
6	POWER	Operating voltage

Operating buttons on the front of the unit:

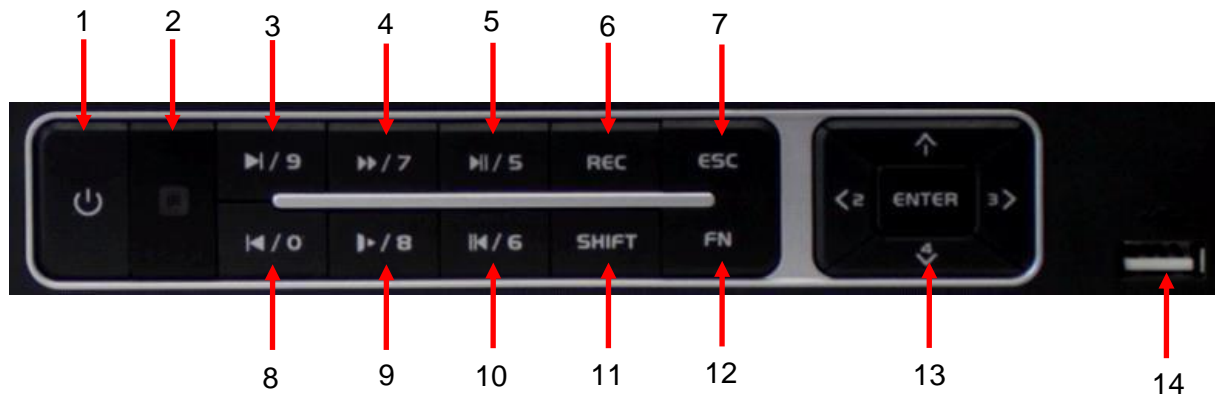

No.	Key	Description
1	On/Off/Login	<ul style="list-style-type: none"> <li>Press 1x briefly: The login window appears</li> <li>With the recorder switched on, press and hold for approx. 3 seconds: The recorder shuts down.</li> <li>Press briefly when the recorder is switched off: The recorder starts up. To do this, however, the on/off toggle switch on the back of the recorder must first be in the "on" position.</li> </ul>
2	IR receiver	Please do not cover

3	Playback, Next	In playback mode, use this to go to the next video. In the menu, use this to go to the last menu item.
4	Fast forward	Fast forward
5	Playback, Pause	Here you can switch between play and pause.
6	REC	This takes you directly to the recording menu. See also: Main menu→ Settings→ Save→ Recording
7	ESC	Cancel the operation and go back to the previous menu page.
8	Back	In playback mode, go back to the previous video. In the menu, use this to go to the last menu item.
9	Slow playback	Slow playback
10	Reverse, Pause	Break
11	SHIFT	When you are in an input field, you can (as an alternative to the virtual keyboard) use the Shift key to switch between letters and numbers as well as upper and lower case.
12	FN	<ul style="list-style-type: none"> <li>• For full screen display: Press this button and the PTZ setting window appears.</li> <li>• For input fields: Press this key to delete the entered characters (letters, numbers).</li> </ul>
13	Up, down, right, left, Enter	As an alternative to the mouse, you can navigate through the menu with the direction keys and confirm your selection with Enter.
14	USB connection	Here you can connect a USB device, e.g. a mouse.

## 2.2 Connections on the rear of the unit

### 2.2.1 BWNVR-2411P

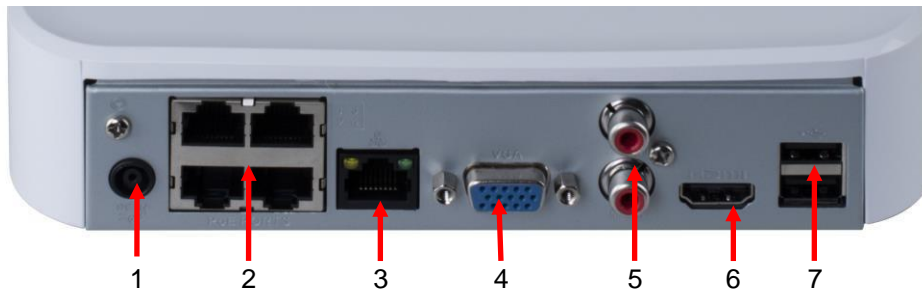

Connection	Description
1	Connection Operating voltage: 48V AC
2	PoE Switch
3	Network connection
4	VGA connection
5	Audio input/output
6	HDMI
7	USB connection

### 2.2.2 SNVR-3842P(e)

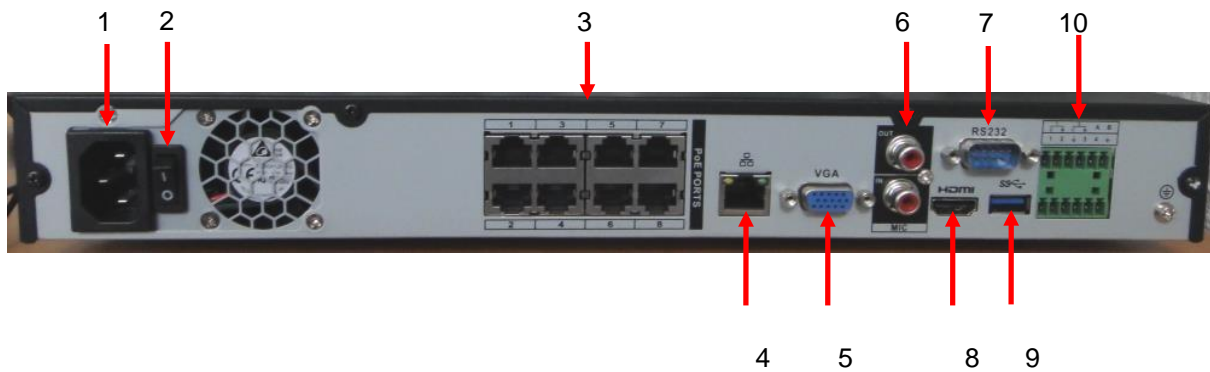

Connection	Description
1	Connection Operating voltage: 230V AC
2	On/Off switch
3	(e)PoE Switch
4	Network connection
5	VGA connection
6	Microphone input/output
7	RS-232
8	HDMI
9	USB connection
10	Alarm outputs, RS-485

### 2.2.3 SNVR-31642e

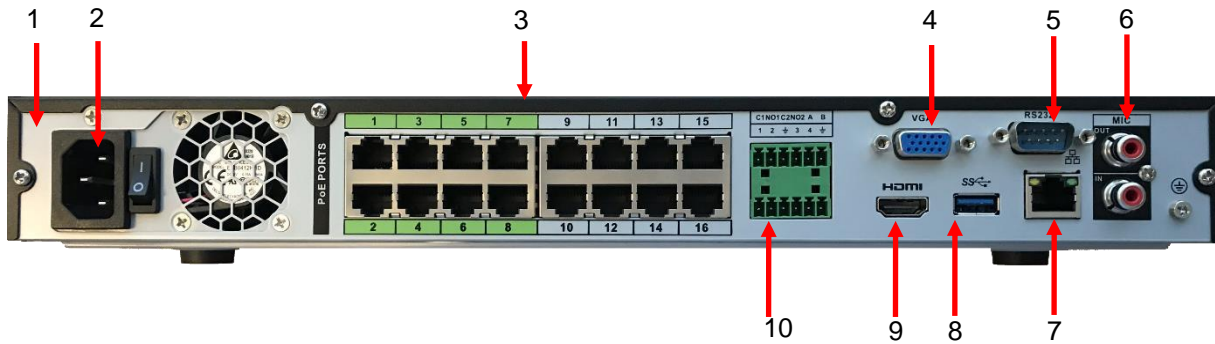

Connection	Description
1	Connection Operating voltage: 230V AC
2	On/Off switch
3	ePoE Switch (green) - Port 1-8 PoE Switch (grey) - Port 9-16
4	VGA connection (FullHD)
5	RS-232
6	Microphone input/output
7	Network connection
8	USB connection
9	HDMI (UHD) output
10	Alarm outputs, RS-485

### 2.2.4 BWNVR-31632Pi

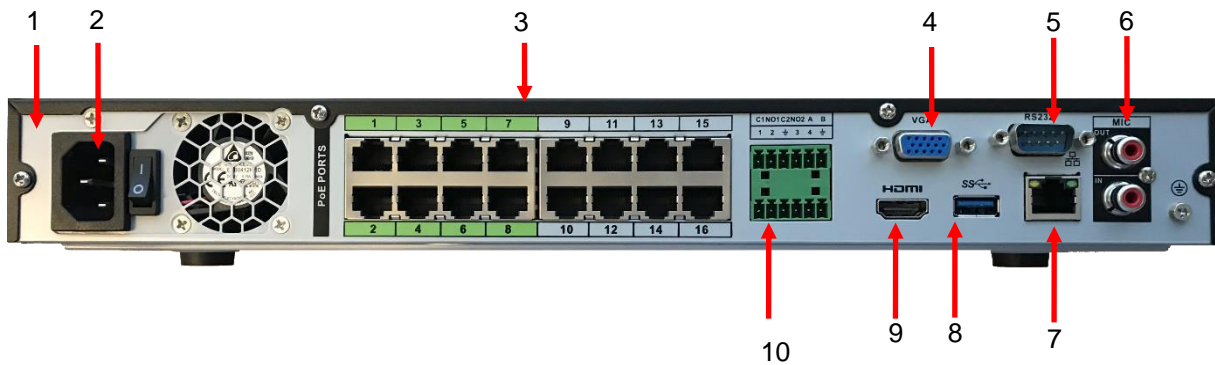

Connection	Description
1	Connection Operating voltage: 230V AC
2	On/Off switch
3	ePoE Switch (green) - Port 1-8 PoE Switch (grey) - Port 9-16
4	VGA connection (FullHD)
5	RS-232
6	Microphone input/output
7	Network connection
8	USB connection
9	HDMI (UHD) output
10	Alarm outputs, RS-485

### 2.2.3 SNVR-36444e

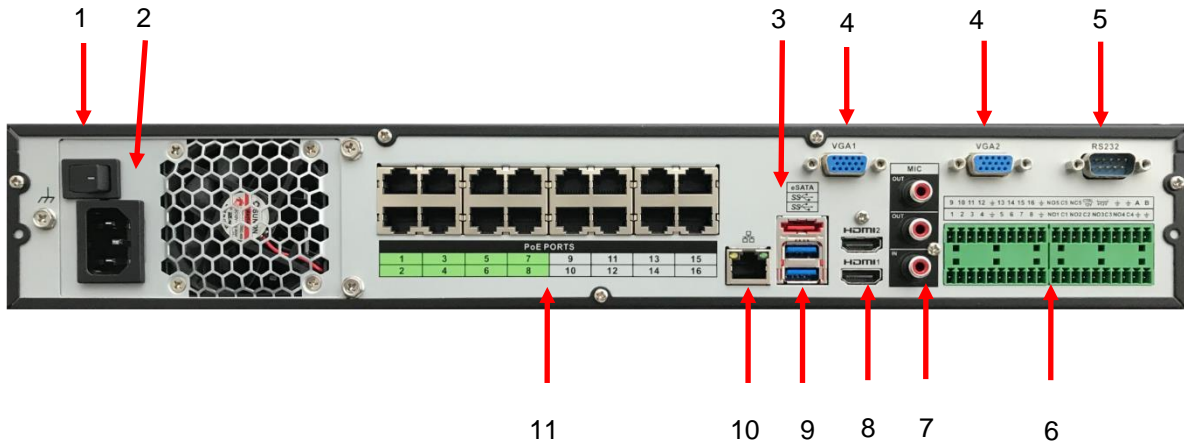

Connection	Description
1	Connection Operating voltage: 230V AC
2	On/Off switch
3	eSATA port
4	VGA1/2 connection (FullHD)
5	RS-232
6	Alarm outputs, RS-485
7	Microphone input/output
8	HDMI 1-UHD / 2-FullHD output
9	USB connections
10	Network connection
11	ePoE Switch (green) - Port 1-8 PoE Switch (grey) - Port 9-16

## 2.2.4 Alarm input and output

Please read the following section carefully before using the contacts.

### 2.2.4.1 Alarm input

The alarm input is switched when the external signal is switched to ground (mode: NO). For this purpose, use e.g. a relay or switch. NO and NC modes are supported.

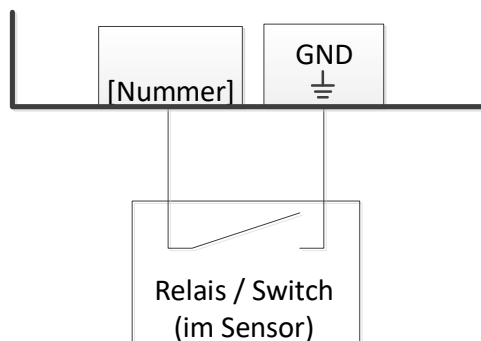

**Note:** If you want to interconnect several recorders, avoid direct series or parallel connection and use separate relay switching contacts for each.



## 2.2.4.2 Alarm output

The recorders use potential-free switching relays JRC-27F as alarm outputs.

The contact pairs are each marked with a number corresponding to NOx and Cx.

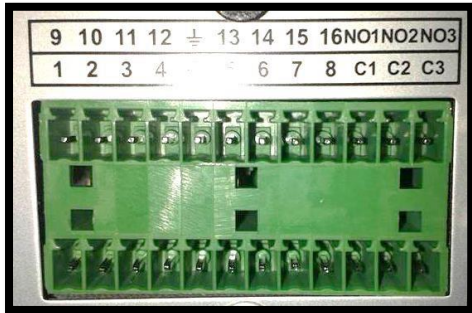

### Example circuit

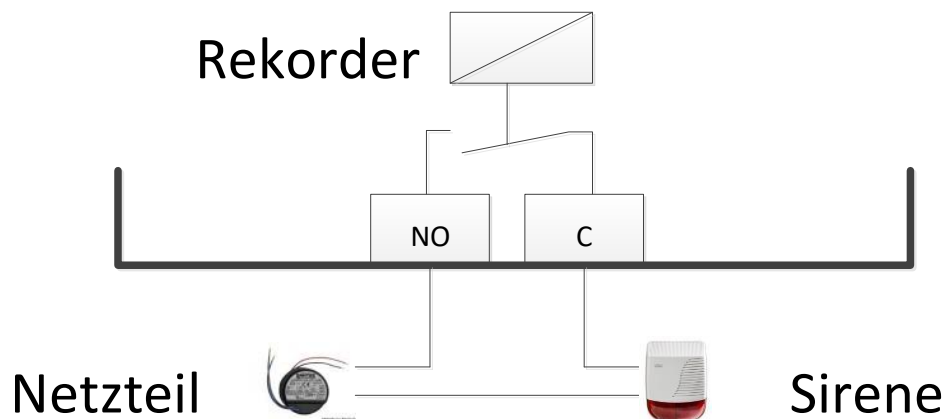

**Important note:** Please refer to the following table for technical data. Values outside the specification may destroy the unit.

Model:	JRC-27F	
Specification	Switching capacity	125VAC 1A / 30VDC 2A
	Max. Switching capacity	125VAAC / 60WDC
	Max. Switching voltage	240VAC / 120VDC
	Max. Current	2A
Contact opening time	< 3ms	
Contact-Closing time	< 3ms	



### 3. Local commissioning

- Connect the mouse, monitor and camera(s) to the recorder
- Connect the monitor and the camera(s) to the operating voltage.
- Finally, connect the recorder to the operating voltage using the enclosed power supply unit.
- Switch on the recorder using the on/off switch on the back of the unit.
- The POWER LED indicator on the front of the recorder lights up green and a beep sounds when the unit is powered up.
- You will first be asked to set the system password. Enter a secure password, confirm it and click on "Next".
- Depending on the default setting, the live image of the camera(s) or the Startup Wizard appears.
  - The Setup Wizard guides you through the rest of the setup. Here you can configure the network settings of the unit, date and time settings, as well as the recording.

#### 3.1 Login

- Enter your user name and password and confirm with "Save".

During the initial setup, you will be asked to create the administrator account.

Important notice:

It is recommended to create an account with a separate password for each user:

Main menu → Settings → System Info → Account → User

You are now logged in and can access the various functions.

Note on incorrectly entered login information:

- If you enter an incorrect user name or password three times within 30 minutes, an alarm is triggered on the system.
- If you make the wrong entries five times, your user account will be blocked for 30 min.

**Note:** A password that is recognised as insecure will not be allowed by the recorder. Use upper and lower case letters as well as numbers and, if necessary, special characters.

Enter your e-mail address for resetting to factory settings if necessary.



### 3.2 Calling up the main menu

There are 2 ways to access the main menu:

- Click on the live image with the right mouse button and select "Main menu" from the quick menu that appears.

Note: You can close the quick menu by right-clicking.

- Alternatively, you can call up the main menu via the navigation bar that appears in the live image when you move the mouse to the lower edge of the screen.

Note: The display of the navigation bar must be activated first.

Main menu → Settings → System Info → General → Navigation bar

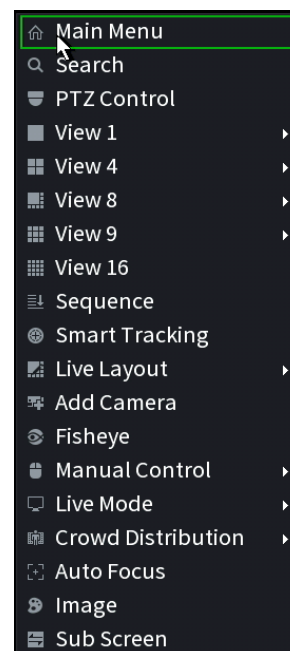

### 3.3 Changing the menu language

- Open the main menu. Select here:

Main menu → Setting → System Info → General → Language

Here you can choose between the pre-installed languages.

Hint:

After changing the language settings, the recorder must be restarted.

### 3.4 Logout and switch off recorder

- Open the main menu. Select:

Main menu → Log off → Shut down

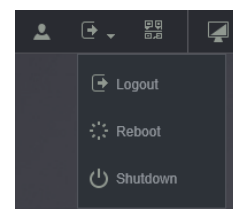

Alternatively, you can shut down the recorder by pressing the On/Off button on the front of the recorder.

- The recorder shuts down, but is still switched on (the LEDs on the front of the recorder are still green). To switch off the recorder for good, you can also switch it off using the power button on the back of the unit.

Hint:

Please always shut down the recorder before switching it off and do not switch it off while it is running, as this could lead to a defect in the components.

### 3.5 Note on cameras

Only network cameras (IP cameras) can be connected to this recorder and their images recorded if they are integrated accordingly and comply with at least ONVIF standard 2.4.

This recorder is an Ultra HD recorder, i.e. it can also record cameras with Ultra HD or 4 K resolution (IP cameras with up to 12 MP resolution maximum).

BURG-GUARD offers a wide range of IP cameras. You can find them in our webshop at: [www.burg-guard.com](http://www.burg-guard.com). Our competent team will be happy to help you find a suitable solution for your request.

### 3.6 Note on the first operation of BURG-GUARD cameras on the PoE port

BURG-GUARD cameras require you to assign a personal, secure password during the first commissioning in order to comply with the requirements according to DSGVO.

If you have not yet commissioned a camera and connect an uninitialised camera to the PoE port of the recorder, the camera is not automatically integrated.

Proceed as follows:

- ➔ Mark the units in the list that you want to initialise.
- ➔ Select (bottom right) "Initialise".

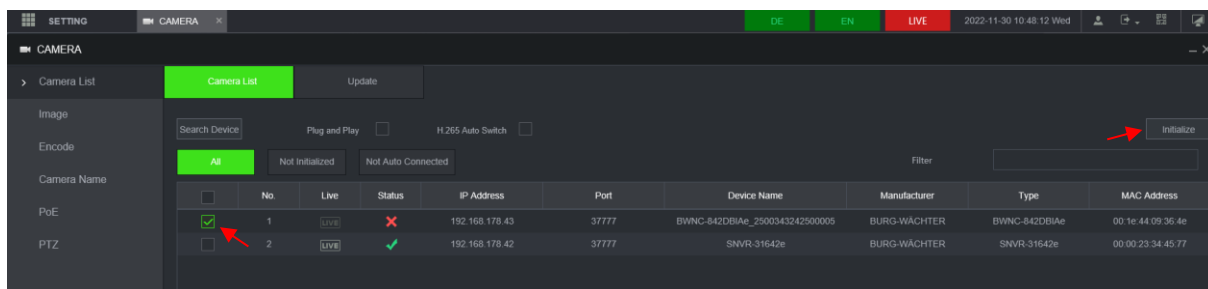

- ➔ Now enter your personal administrator password or accept the recorder password (default).

Benutzer	admin
Passwort	<input type="password"/>

- ➔ When you confirm the entry, the account data is transferred to the cameras.

Adjust the user name and password of the camera in the recorder menu to the new settings. Then restart the system.



## 4. Operating the recorder

### 4.1 Operating the recorder with the mouse

You can operate the recorder with the mouse supplied. To do this, connect the mouse via the USB port on the rear or front of the recorder.

#### Single click left mouse button:

With a single click of the left mouse button, you can select various menu items or make entries. You can also close the quick menu with the left mouse button.

#### Double-click left mouse button:

In the live multiple view, double-click with the left mouse button on the respective camera image to display it in full screen.

Double-click again in the full screen to return to the split view.

#### Single click right mouse button:

If you click once with the right mouse button in the live view, a quick menu opens in which you have the following selection or setting options:

- View(s)
- PTZ
- Fisheye
- Auto Focus
- Picture settings
- Search
- Control
- Camera Settings
- Main menu

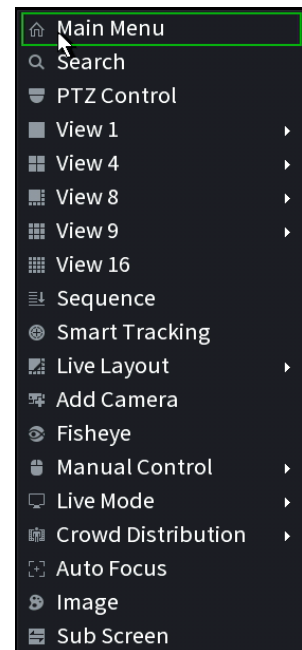

Click once with the left mouse button, e.g. into the Live image to close the menu again.

### Input via the virtual keyboard:

For some input fields, clicking in the field opens a virtual keyboard that you can use to enter letters, numbers or characters.



Upper case letters



Lower case letters



Numbers and special characters

## 4.2 Operating the recorder with the IR remote control

In addition to operating the recorder using the buttons on the front of the unit and the mouse, there is another option:

You can also control the recorder with the IR remote control. To do this, point the remote control at the IR reception field on the recorder (must not be covered).



When you press a button on the remote control, the ACT light on the front of the recorder flashes briefly.

## 5. Functional description

### 5.1 Live-Ansicht

#### 5.1.1 Ereignis Anzeige



### 5.1 Live view

#### 5.1.1 Event display

In the live view, the action is displayed at the bottom of the image:

Symbol	Description
	Recording is running on this channel.
	Movement detected on this channel.
	Signal loss (image loss) on this channel.
	Camera image locked for live view.

#### 5.1.2 Calling up the menu bar

If you touch the upper live image edge of the respective channel with the mouse pointer, the following small menu bar is displayed:



1. Real-time playback:

If you click on this symbol, the last 5-60 minutes of the recorded videos on this channel are played back. If there is no recording for this channel during this period, a corresponding message appears.

You can set the time period from 5 to 60 minutes.

2. Enlarge (zoom):

When you click on this icon, it changes to a tick.

You can then zoom in on the image for this channel in the following two ways:

- Hold down the left mouse button and drag a box around the picture element you want to zoom in on.
- You can zoom in on the picture with the mouse wheel.

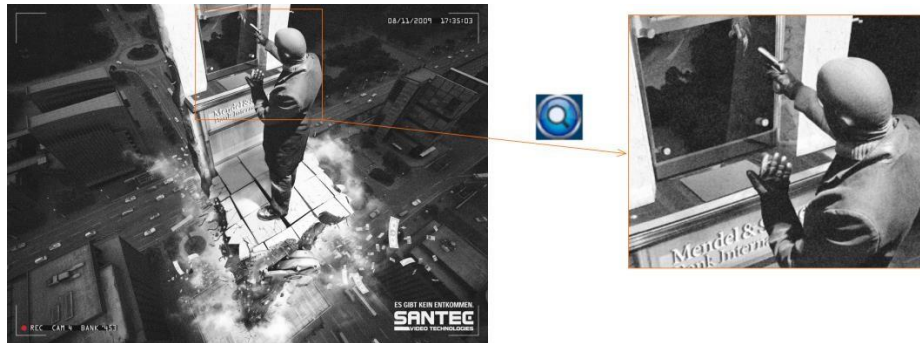

Clicking the right mouse button returns you to the original image.

3. Manual recording (video):

When you click on this symbol, manual recording starts. Click on the symbol again to stop the recording. The video data recorded in this way is saved on a connected USB device (e.g. stick).

4. Manual snapshot:

If you click on this symbol, you can create a snapshot of the current image. This is then saved either on a connected USB device (e.g. stick) or on the hard disk.

5. Sound:

This function is only available if the camera supports the audio function and the corresponding devices are also connected.

6. Channel selection:

Select which of the streams you want to display.





## 5.2 Access to the quick menu via right mouse button

If you are in the live view (regardless of whether you are in the multiple view or full screen of a channel) and click once with the right mouse button, a quick menu opens in which you have the following selection or setting options:

- View(s)
- PTZ
- Fisheye
- Auto Focus
- Picture settings
- Search
- Control
- Camera Settings
- Main menu

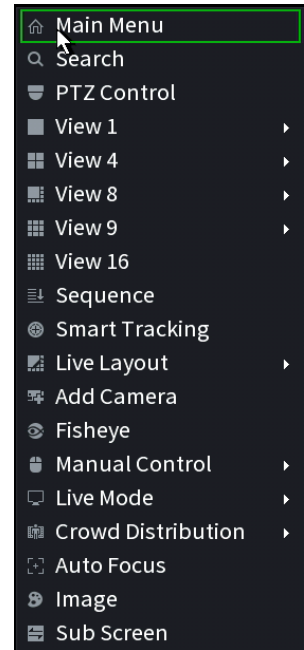

If you click into the live image again with the left mouse button, the quick menu is closed again.

### 5.2.1 View(s)

Here you can view a channel as a full screen or a split screen. Select the screen view (multiple view). Depending on the recorder model, you can choose from different variants of the multiple view is available.

Via Sequence you can select scheduled sequences and run them periodically.

You can call up user-defined displays via Ben. Display.

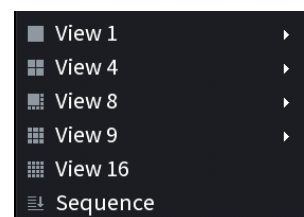

## 5.2.2 PTZ control

### 5.2.2.1 Overview

This function is only available if you have connected a PTZ-capable camera. When you click on "PTZ", the following control window appears:

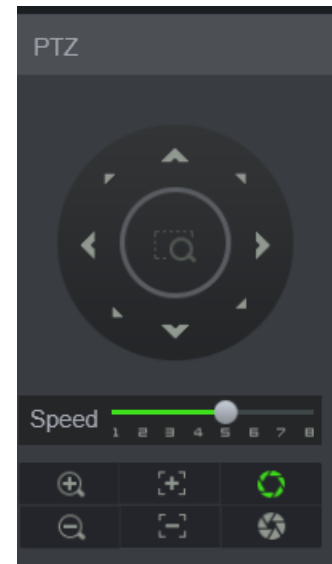

#### Speed:

Here you can set the speed of the PTZ movement (values from 1-8). To do this, click in the speed number field and enter the desired speed value via the virtual keyboard that opens.

#### Zoom, focus, iris:

You can use the respective plus and minus buttons to adjust the zoom factor, focus and aperture.

#### Icon

Display full screen



#### PTZ direction:

You can perform PTZ control for 8 directions (=8 arrows) by clicking on the respective arrow key.

In the middle of the direction arrows is the 3D positioning button.

If you click on this button, the camera image is displayed as a full screen.











Keeping the left mouse button pressed, drag an area into the picture. This area can then be displayed at up to 16 times the speed. The smaller your selected area, the higher the speed.



### Setting of preset, tour, pattern, etc:

If you click on the arrow key on the right edge in the PTZ menu, the menu window expands as follows:



Symbol	Function	Symbol	Function
	Preset		Flip
	Tour		Reset
	Pattern		Aux Config.
	Autoscan		Aux on/off
	Autopan		Call up menu

### 5.2.2.2 Aux configuration

Click on the configuration icon.  
The following menu window opens:

#### Preset:

- For the preset setting, you can use the directional arrows to move the camera to the desired position.
- Enter the desired number for this preset.
- Save the setting by clicking on "Set".
- You can undo your entry via "Delete preset".

#### Tour:

- For the tour setting, the direction arrows are available to move the camera to the desired position.
- Enter the desired number for the preset and this tour.
- Save the setting by clicking on "Add Preset".
- With "Delete Preset" or "Delete Tour" you can undo your entry.

#### Pattern:

- For the pattern setting, the direction arrows are available to move the camera to the desired position.
- Enter the desired number for the pattern.
- Click on "Start" or "End".

#### Border:

For the boundary setting of a scan operation, the direction arrows are available to set the boundary to the left or right for the camera.

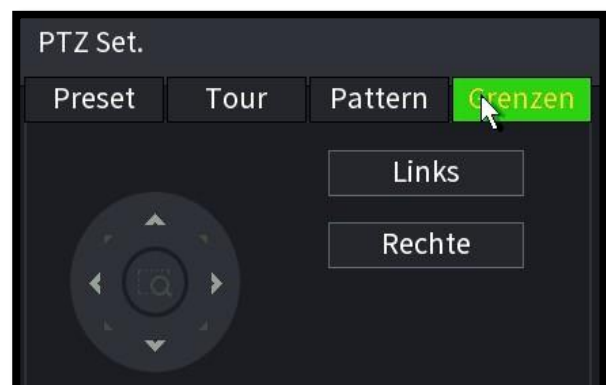
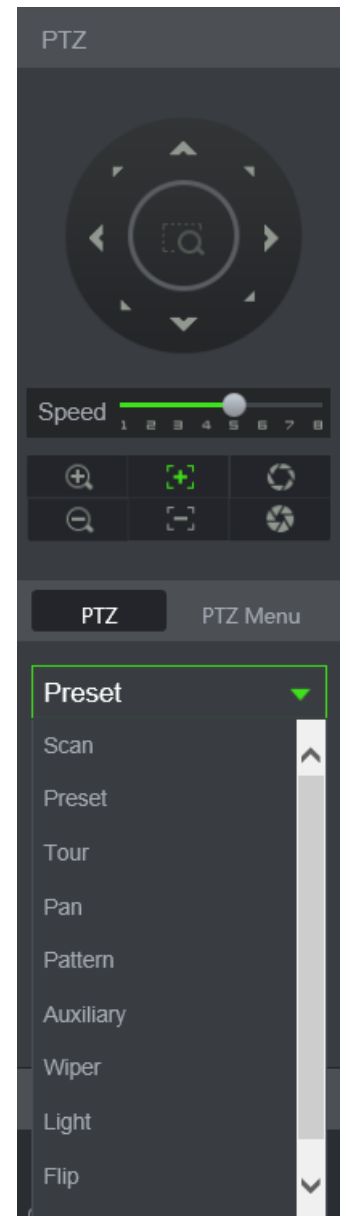

### 5.2.2.3 Aux

Click on the Aux icon.  
The following menu window opens:

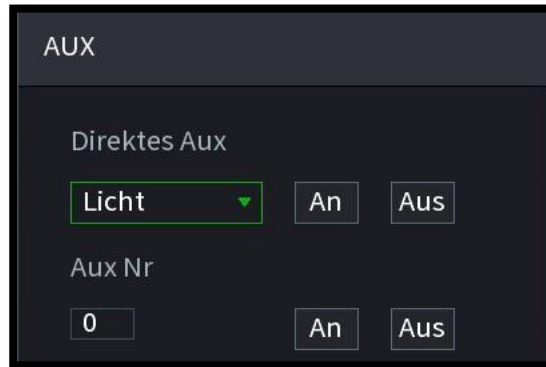

The options defined here depend on the selected protocol. The "Aux Num" corresponds to the Aux On/Off button of the decoder.

The "screen wiper" function can only be activated if the connected camera has a housing with a wiper function.















### 5.2.3 Fisheye

**Hint:**

This function is only active if you have connected an IP camera with a fisheye lens.

There are 3 installation options for the camera: ceiling mount, wall mount and floor mount. Different equalisations apply to each of these 3 mounting options.



Installation mode	Symbol	Description
 Ceiling mounting   Floor mounting		360° original all-round view
		1 rectification window + 1 stretched panorama
		2 stretched panoramas
		1 360° all-round view + 3 equalisation windows
		1 360° all-round view + 4 equalisation windows
		4 rectification windows + 1 stretched panorama
		1 360° all-round view +8 equalisation windows
Wall mounting		360° original all-round view
		Stretched panorama
		1 unfolding panorama +3 equalisation windows
		1 unfolding panorama +4 equalisation windows
		1 unfolding panorama +8 equalisation windows

By positioning the mouse in one of the coloured areas, you can zoom into the image (mouse wheel) or realign the view (left mouse button pressed).

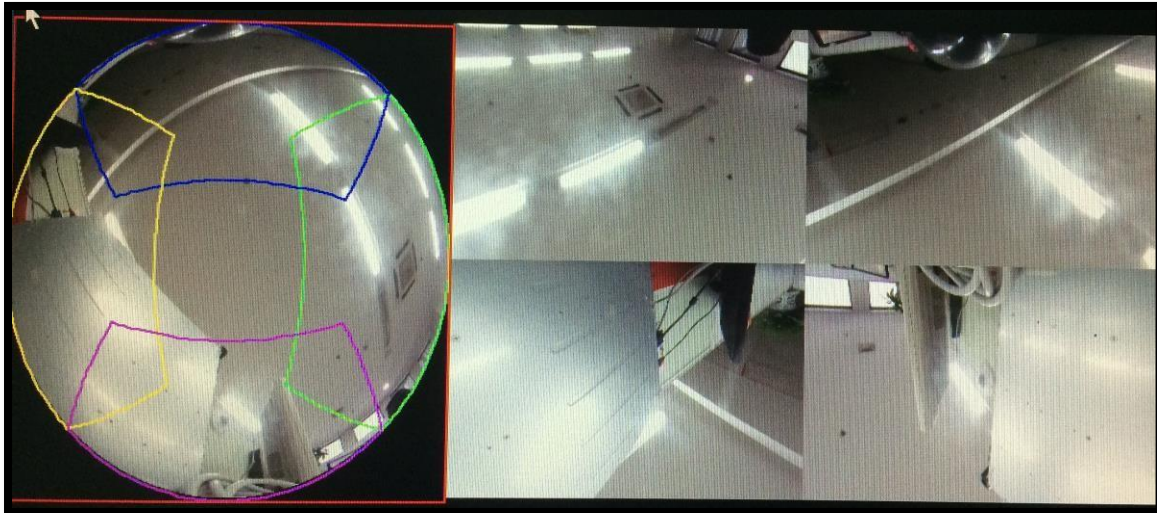

## 5.2.4 Auto Fokus

### 5.2.4 Auto Focus

Click [here](#) to adjust the zoom and focus of a camera manually or automatically.

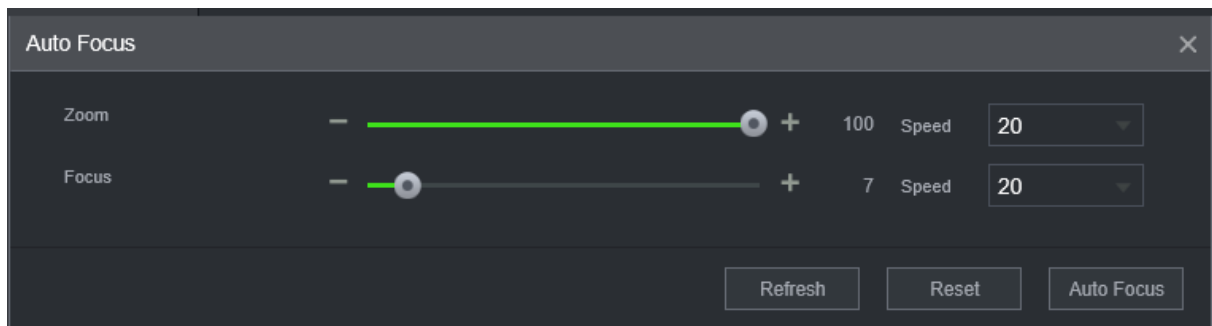

## 5.2.5 Camera

Here you can make a number of camera settings.

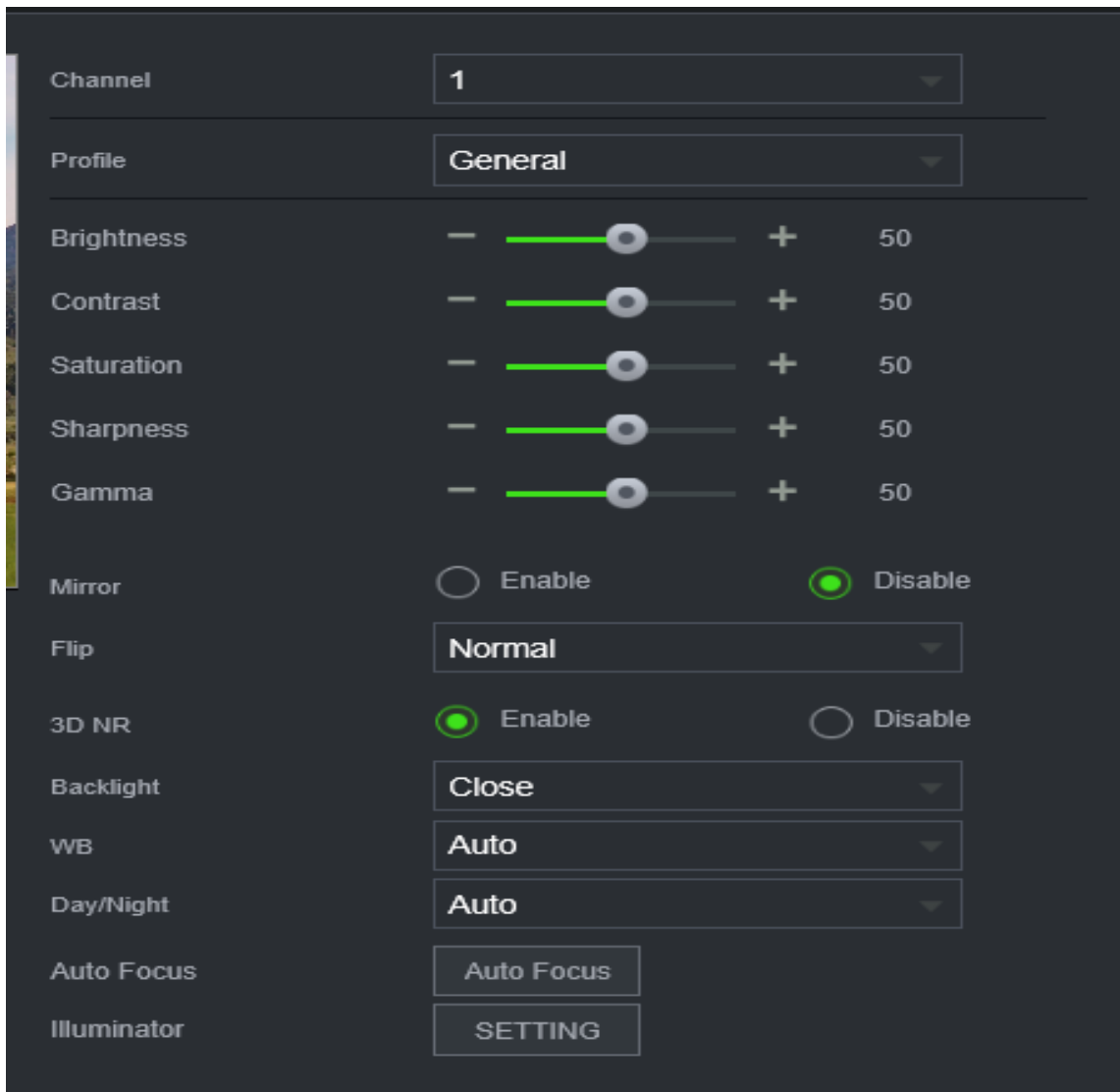

Note: The entire functions of a camera can only be set via the web interface of the camera itself. Only a selection of the most important settings is displayed in the recorder.

## 5.2.6 Search

This shortcut takes you to the "Search" menu.

## 5.2.7 Manual

Start a manual recording or trigger an alarm.





## 5.2.8 Camera Settings

Opens the menu for finding and integrating cameras in the network.

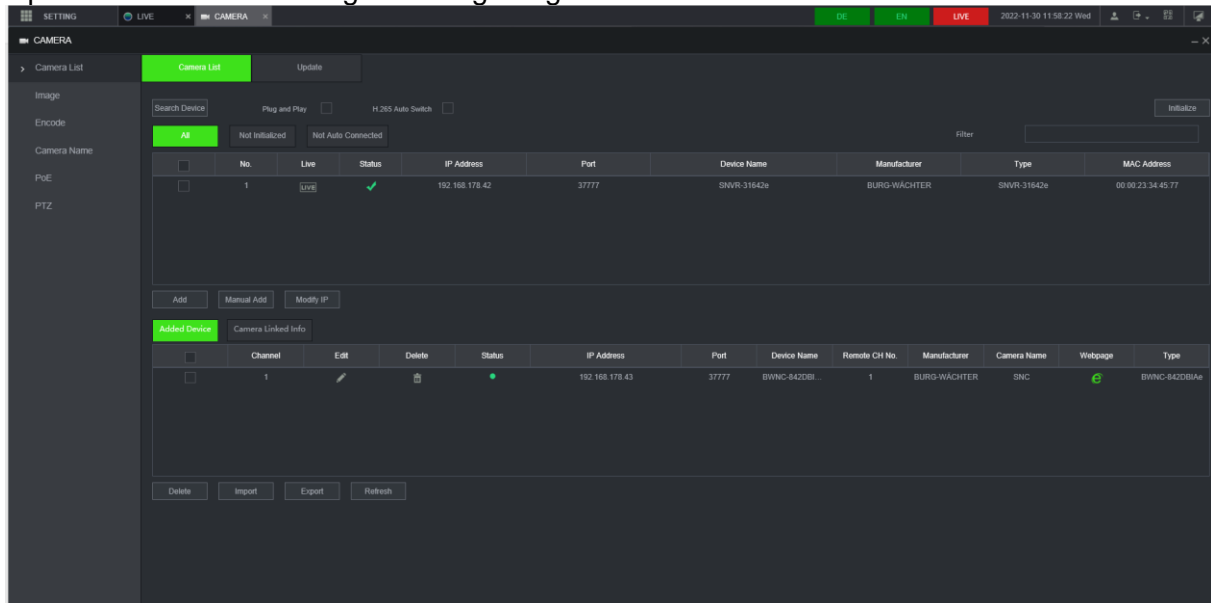

## 5.2.9 Main menu

Opens the first page of the main menu of the recorder.

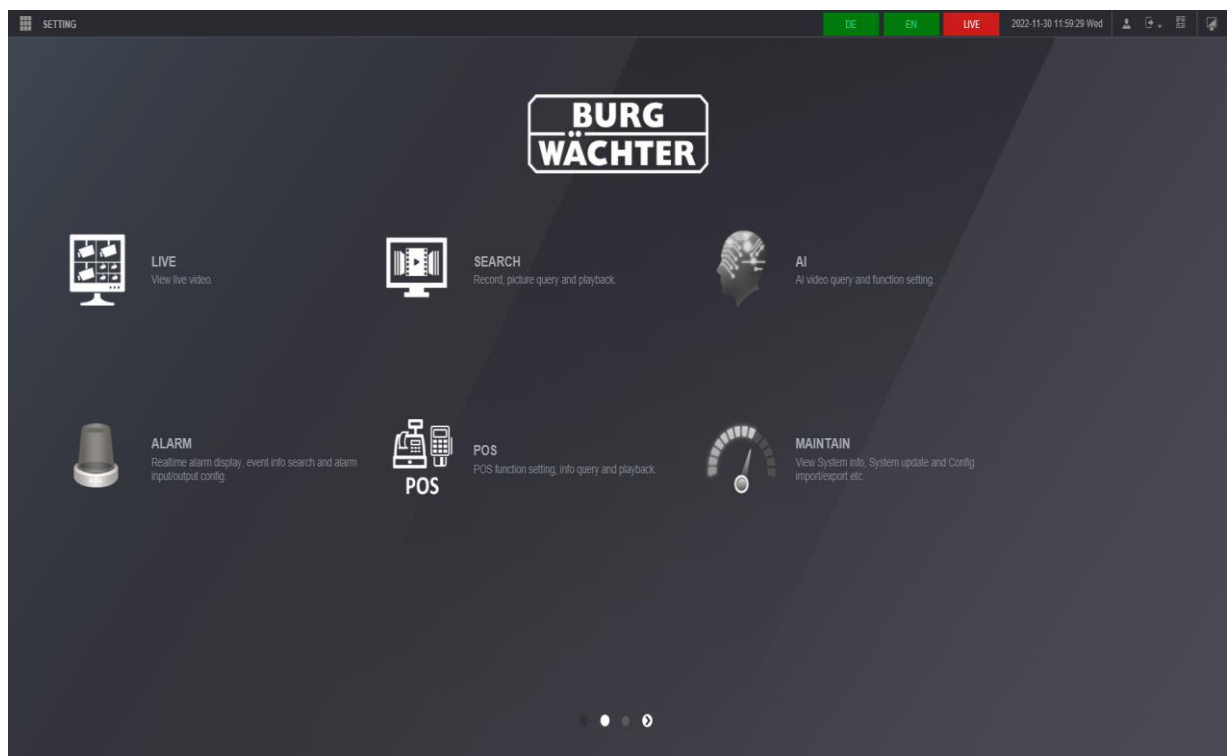

### 5.3 Calling up the navigation bar

You must first activate the display of the navigation bar so that it can be displayed in the live image.













Activate the navigation bar here:

Main menu → Settings → Navigation bar



After you have activated the navigation bar, it is displayed in the live image when you click with the left mouse button.

The main menu is opened by clicking on the little house symbol.

Symbol	Description
	Call up the main menu.
	Display mode: full screen or multiple view
	Page forward/back / Start tour or Tour running
	Call up the PTZ control.
	Here you can make camera settings, e.g. contrast, colour tone, mirroring, flip, etc.
	Call up the search functions.
	Call up the alarm status display. The unit status and the channel status are displayed here.
	Call up the channel information. Events such as detected movement, video loss, sabotage, etc. are displayed here for each individual channel.
	Here you can add or delete devices.
	Access the network settings.
	Here you will find information about the hard disk.
	Here you will find information about the USB Manager, e.g. backup and upgrades.

## 5.4 USB Car Pop-up

If you connect a USB device (e.g. stick) to the recorder, it is recognised by the recorder and the following window appears:

You can select whether you want to perform a backup or an upgrade via the USB device. (See also Import/Export) or (Upgrade).

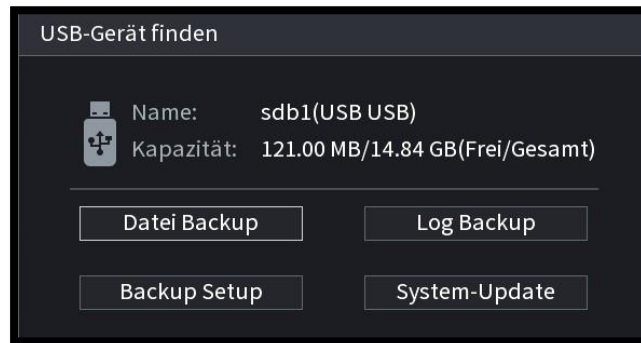

**Hint:**

If you want to save videos from the recorder to a USB stick, please note the video format in which the file is to be saved.

## 6. Settings via the main menu

There are two ways to access the main menu:

- Via the quick start menu  
Click into the live image with the right mouse button and click on the line "Main menu".
- About the navigation bar  
Click into the live image with the left mouse button and select the main menu symbol (house).

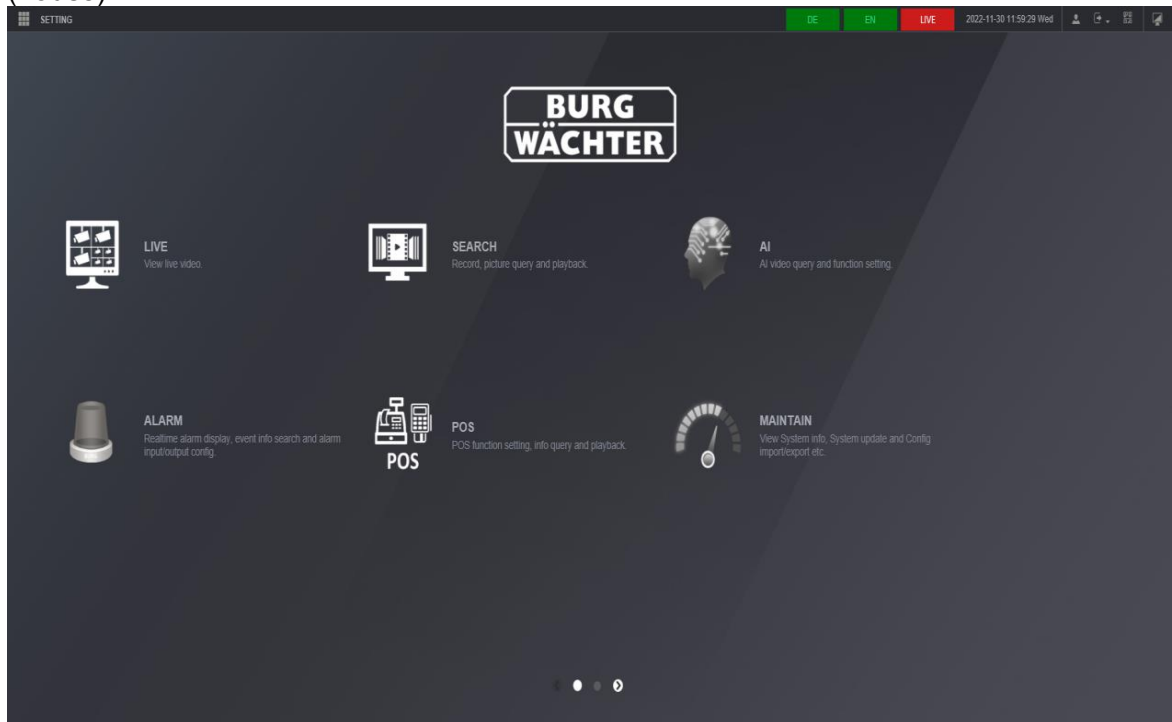

The main menu depends on the range of functions and is structured as follows:

### Page 1

- Live
- Playback and search of events
- AI IVA (setting, search, parameters)
- Alarm(s) a.o. motion detection
- POS (Point of Service - meta data processing from 3. systems)
- Application(s) of the system (information, network, system maintenance, ...)

### Page 2

- Backup
- Display
- Audio

### Administration

- Camera (integrate cameras and make picture/streaming settings)
- Network (protocols and ports)
- Memory
- System
- Accounts (user / rights management)





## 6.1 Main menu → Live



In the live display of the recorder, the live images of the cameras are displayed, depending on the settings made.

**Note:** By default, the camera images are blacked out after the set auto logout time. If you want a permanent display of the live images, please activate this in the settings under: Main menu → Display → Display > Activate the permanent display of the desired channels.

In the live view, the action is displayed at the bottom of the image:

Symbol	Description
	Recording is running on this channel.
	Movement detected on this channel.
	Signal loss (image loss) on this channel.
	Camera image locked for live view.













## Navigation bar

Note: You must first activate the display of the navigation bar so that it can be displayed in the live image. You can activate the navigation bar here:

Main menu → Display → Navigation bar

After you have activated the navigation bar, it is displayed in the live image when you click with the left mouse button.



SYMBOL	DESCRIPTION
	Call up the main menu.
	Display mode: full screen or multiple view
	Page forward/back / Start tour or Tour running
	Call up the PTZ control.
	Here you can make camera settings, e.g. contrast, colour tone, mirroring, flip, etc.
	Call up the search functions.
	Call up the alarm status display. The unit status and the channel status are displayed here.
	Call up the channel information. Events such as detected movement, video loss, sabotage, etc. are displayed here for each individual channel.
	Here you can add or delete devices.
	Access the network settings.
	Here you will find information about the hard disk.
	Here you will find information about the USB Manager, e.g. backup and upgrades.



If you are in the live view (regardless of whether you are in the multiple view or full screen of a channel) and click once with the right mouse button, a quick menu opens in which you have the following selection or setting options:

- View(s)
- PTZ
- Fisheye
- Auto Focus
- Picture settings
- Search
- Control
- Camera Settings
- Main menu

If you click into the live image again with the left mouse button, the quick menu is closed again.

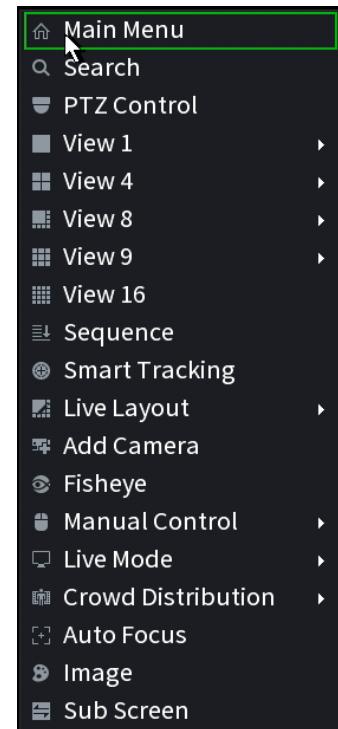

## 6.2 Main menu → Playback View

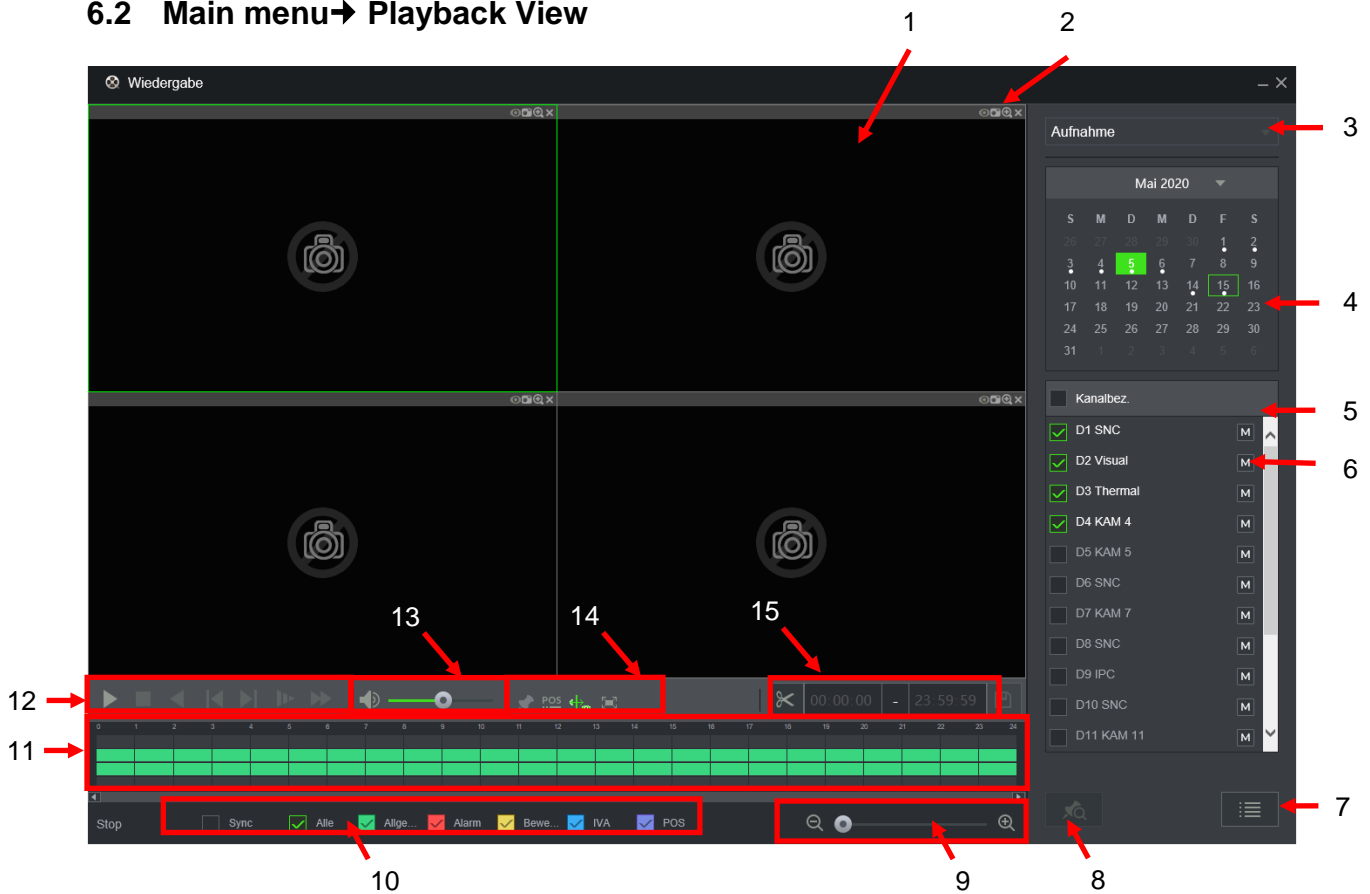

No.	Symbol	Function
1	Display- Windows	The image or file you are looking for is displayed here. Full screen or multi-screen view is supported during playback.
2	Short keys	Fisheye View / Snapshot / Zoom / Close Channel
3	Data type	Choose between video playback or snapshots
4	Calendar	Use the calendar to select the date for the search. If a date is highlighted in colour, the day is selected. If the day is marked with a dot, recordings are available for this day.
5	Channel selection	Select the channels you want to display. The display/timeline is shown according to the selection made.
6	Stream	Select whether you want to display the main stream or the sub-stream.
7	Data	Opens the list of stored video/image data, depending on the selection (3).





8	Bookmark	Here you can call up the bookmark search for the respective channel.
9	Zoom timeline	Zoom the timeline to the current playback time
10	Event	Select which event/permanent recording is to be displayed.
11	Timeline	Timeline with colour markers of events

(continued on next page)

No.	Symbol		Function
12	Re-issue panel	▶	Play forward/pause: You can start playback in the following ways: <ul style="list-style-type: none"> <li>• Click on the playback symbol.</li> <li>• Double-click on the corresponding time in the timeline.</li> <li>• Double-click on the desired file in the detail list.</li> </ul> Click the play icon again to switch between play and Pause.
		■	Playback Stop
		◀	Playback back: In playback mode, you can play back the file/image by clicking on this symbol. If you click the symbol again, the playback is interrupted (pause).
		◀   ▶	Previous Frame / Next Frame: In playback mode, you can go to the next or previous picture by clicking on this symbol. You can press the symbol several times.
		▶	Slow playback: In playback mode, you can play the file/image by clicking on this icon.
		▶▶	Fast forward: In playback mode, you can play the file/image by clicking on this icon.
13	Volume		Volume control of the playback
14	Overlays		Show/hide POS display
			Switch to full screen view
			Marker/Bookmark
			Show/Hide IVA Rules
15	Excerpt		Connect a USB stick to the recorder to transfer data from the selected time range to USB.

## 6.2.1 Main menu → Playback Bookmark

## 6.2.2 Main menu → Playback Bookmark → Set marker

To set a marker (bookmark), select a live window and tap on the marker icon:

In the window that appears, enter the name of the marker you want to add to the bookmark list.

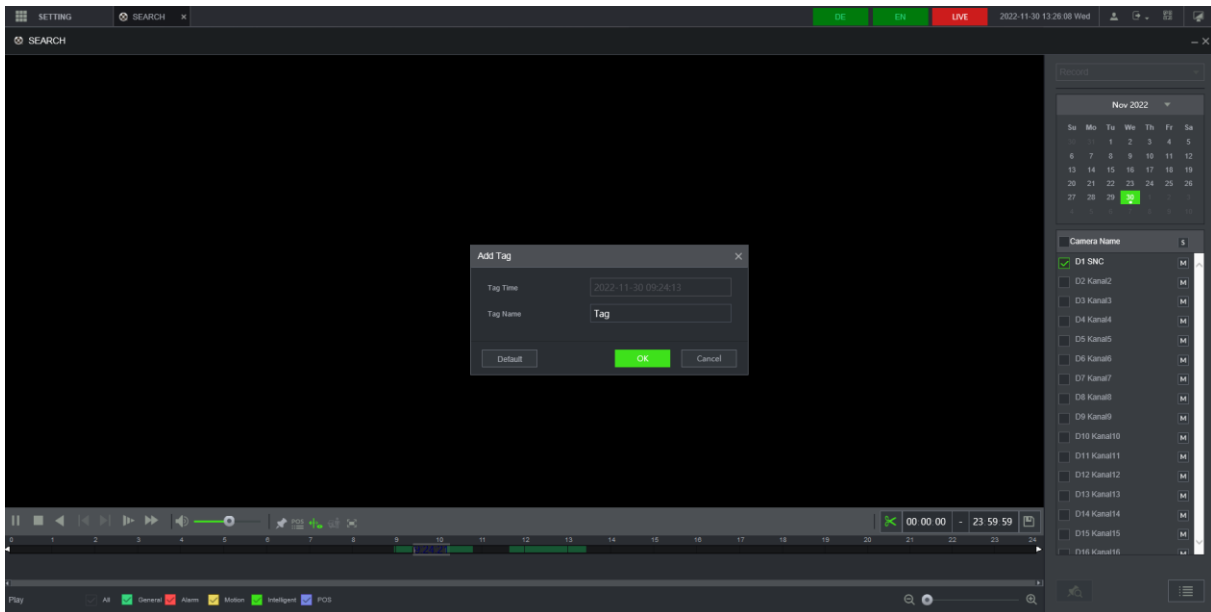

### 6.2.3 Main menu → Playback Bookmark → Search marker

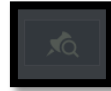

To search for a marker, select a channel in the playback menu and then click on " " to display the set markers.

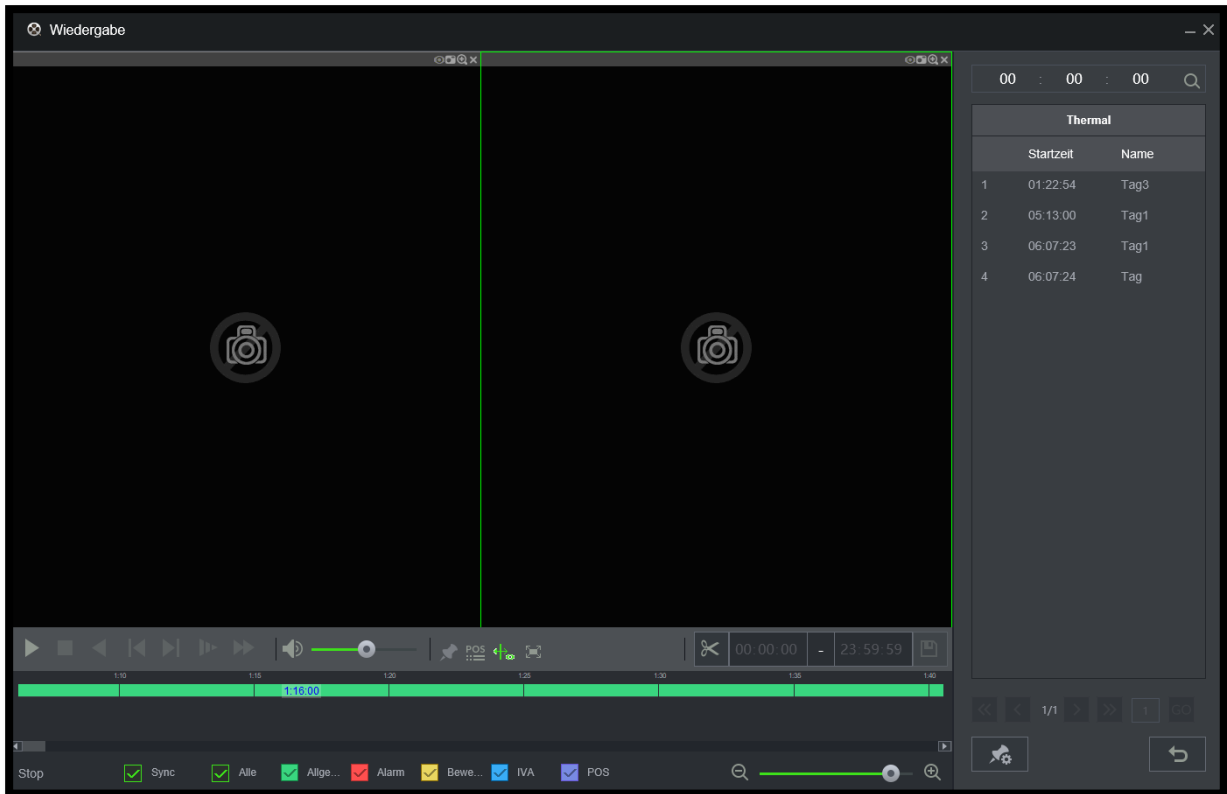

Select a marker from the list (right) to jump to the marked time in the video.



You can exit the menu with " " and return to normal playback.



To edit a bookmark entry click on: " ".

## 6.2.4 Main menu → Playback Bookmark → Edit/remove marker



To edit / remove a marker click on "  ".S

Tag Management ✕

Channel  Search

Start Time   End Time

<input type="checkbox"/>	No.	Channel	Tag Time	Tag Name
<input type="checkbox"/>	1	1	2022-11-30 12:45:58	Tag
<input type="checkbox"/>	2	1	2022-11-30 12:46:04	Tag2

Delete Back

### Remove marker

To remove the marker(s), place a tick on the left-hand side and then click on "Del.

### Search marker

To search for a marker, select the channel, set the date and time of the period you are looking for and click on "Search". The result is displayed in tabular form.

## 6.3 Main menu → AIVA

Manage AI/KI/ Intelligent Event recordings and search for them specifically.

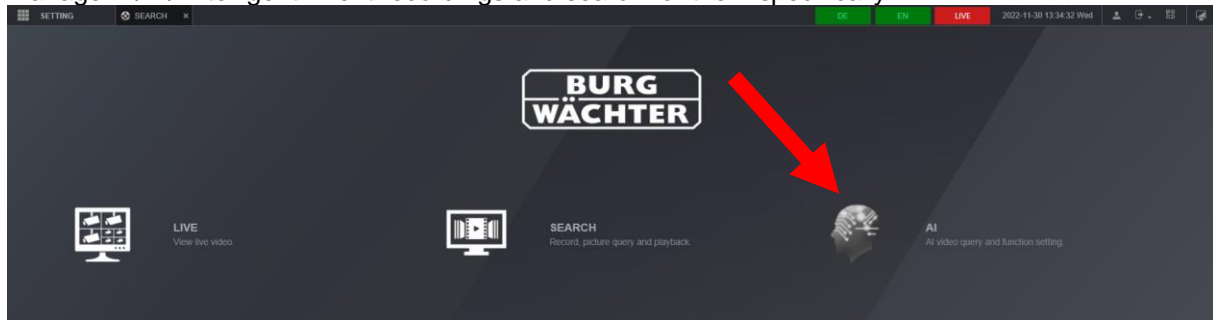

For example, it is possible to filter specifically for triggered events such as a person entering an area, provided the corresponding functions were active at the time of recording.

### 6.3.1 Main menu → AIVA → Intelligent search

In the intelligent search, you can search specifically in the recorded data and evaluate analyses.

Note: In order for an evaluation of the data to take place, the recordings must have been taken under certain AI IVA and event conditions.

#### 6.3.1.1 Face recognition

Prerequisite: The selected camera channel supports the function and the data was recorded with the AIVA function "Face detection".

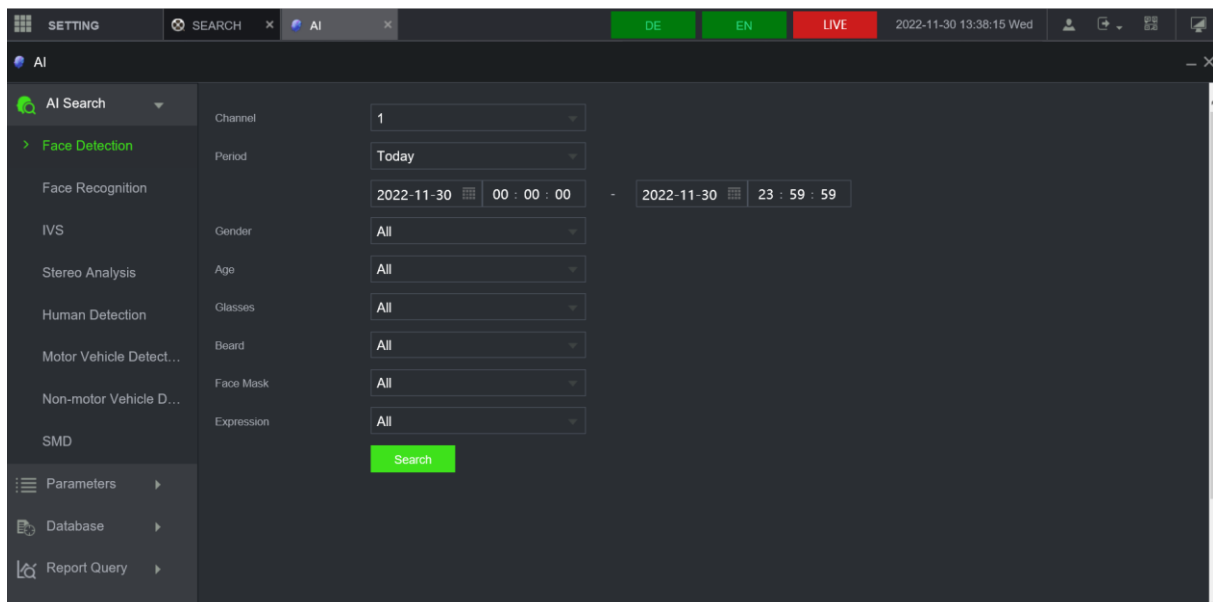

- Select a channel that supports the AIVA face recognition function.
- Enter the search interval (start time / end time) with date and time.
- Select the appropriate search filter functions from the list of parameters. Be aware of the possible uncertainties of the image acquisition and algorithms.
- Click on Search to display the result

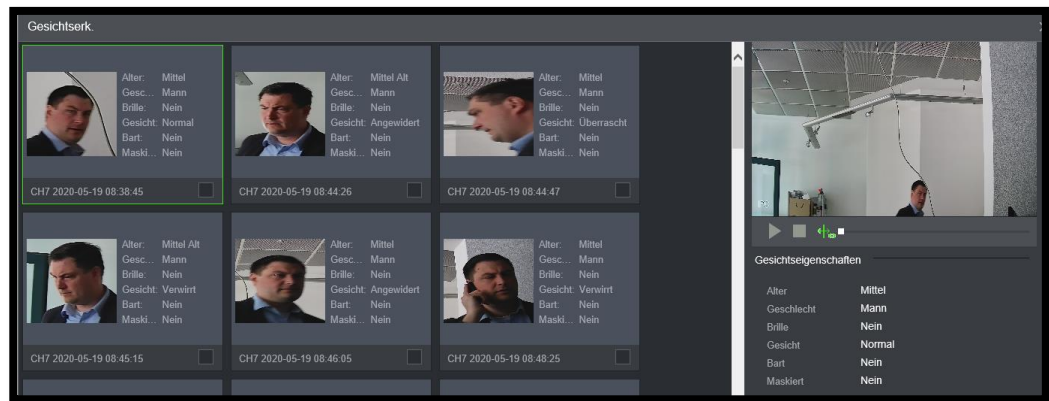

- Select an image from the event list. In the right-hand window you can see the preview of the recording.

### 6.3.1.2 Face recognition

Prerequisite: The selected camera channel supports the function and the data was recorded with the AIVA function "face recognition".

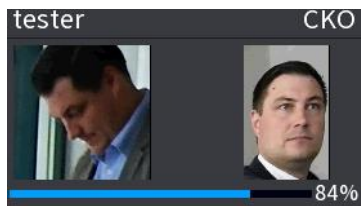

Below the image, the relative accuracy of the recognition is shown.

Blue - low

Red - high

### 6.3.1.3 IVA / AIVA

Search for a targeted event trigger, or for all events that were recorded via video analysis.  
E.g. (tripwire, entering/leaving zone, loitering, no parking,...)

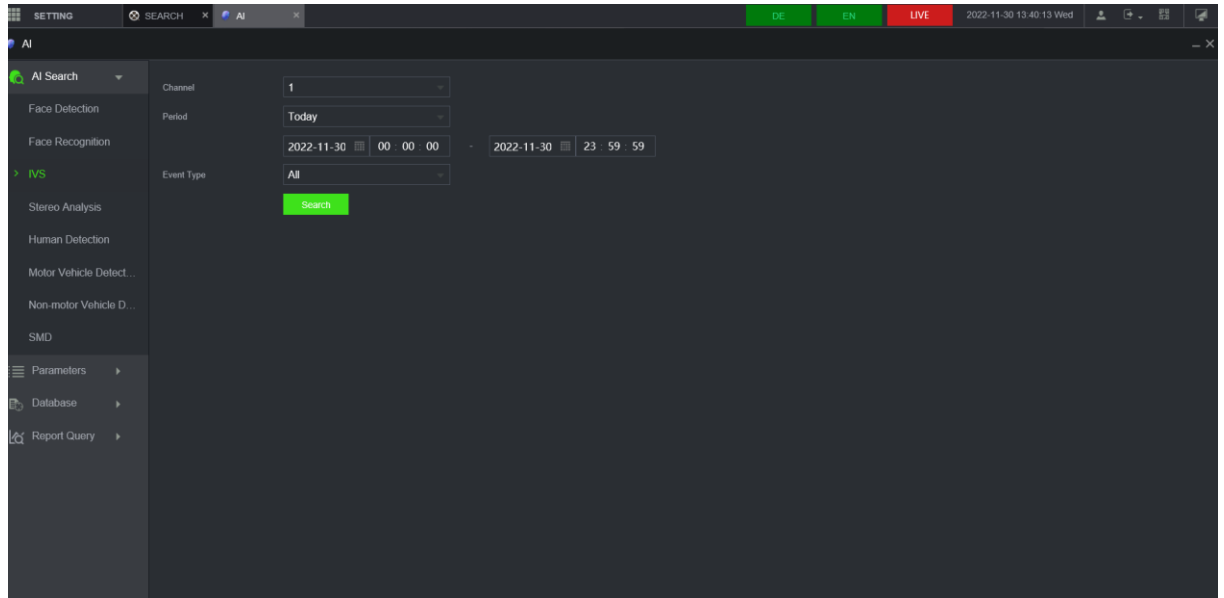

- The result is displayed as a list.
- Select an event to view the recording.

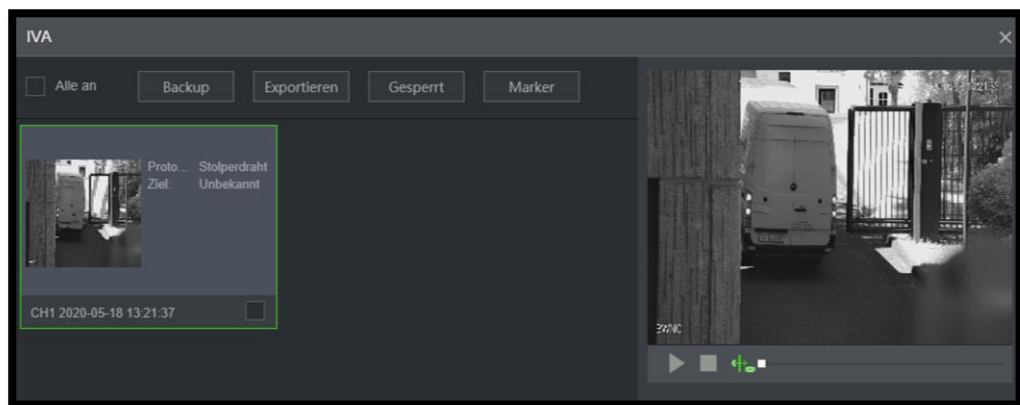



### 6.3.1.4 Person recognition

- Select a channel that supports AIVA video analysis.

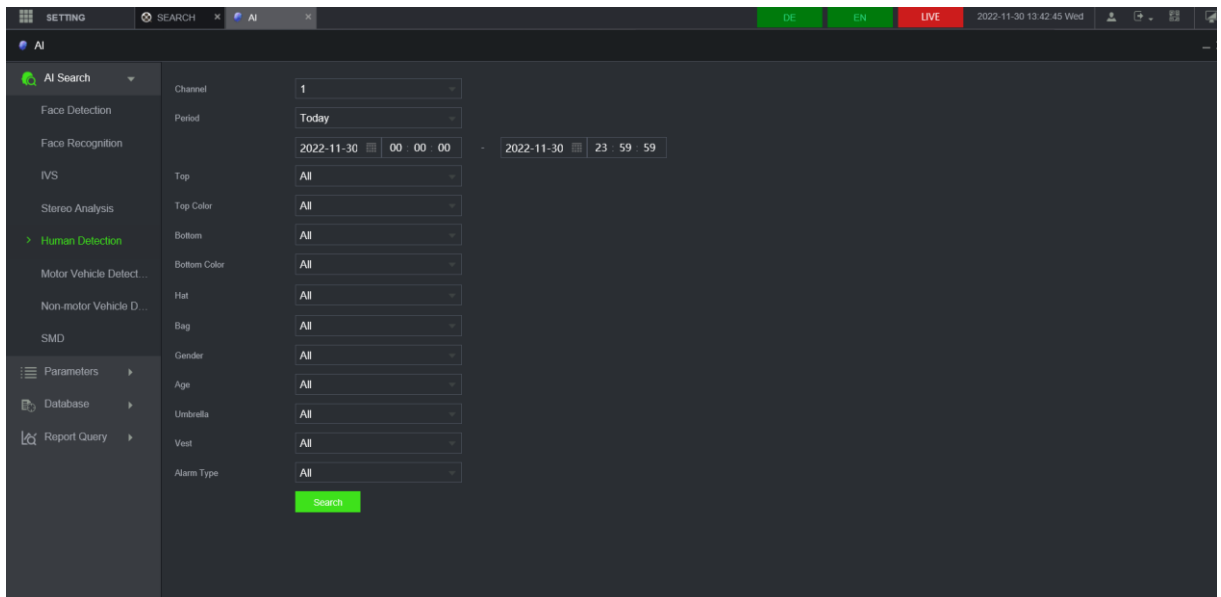

- Enter the search interval (start time / end time) with date and time in which you suspect the event.
- Select the appropriate search filter functions from the list of parameters. Be aware of the possible uncertainties of the image acquisition and algorithms.
- Click on Search to display the filtered result.

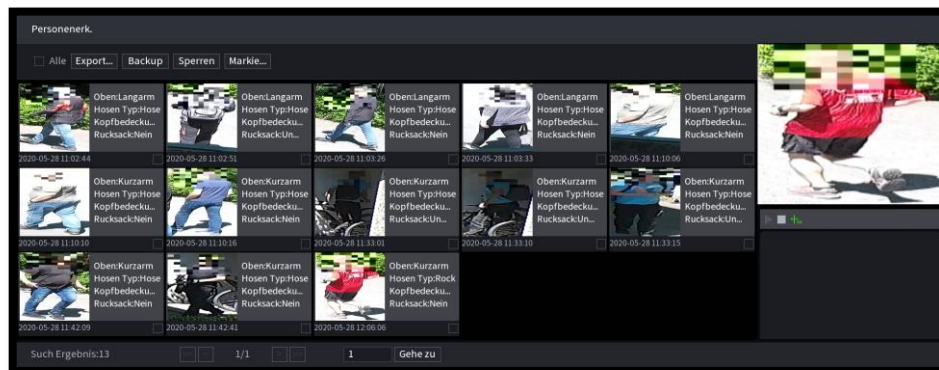

**Note:** When filtering, consider possible deviations caused by e.g. IR night vision recording, shadows, multi-colour, insufficiently detailed images.

### 6.3.1.5 Vehicle recognition

By setting appropriate filter functions, you can search specifically for vehicles with certain characteristics.

Note: When filtering, consider possible deviations caused by e.g. IR night vision recording, shadows, multi-colour, insufficiently detailed images.

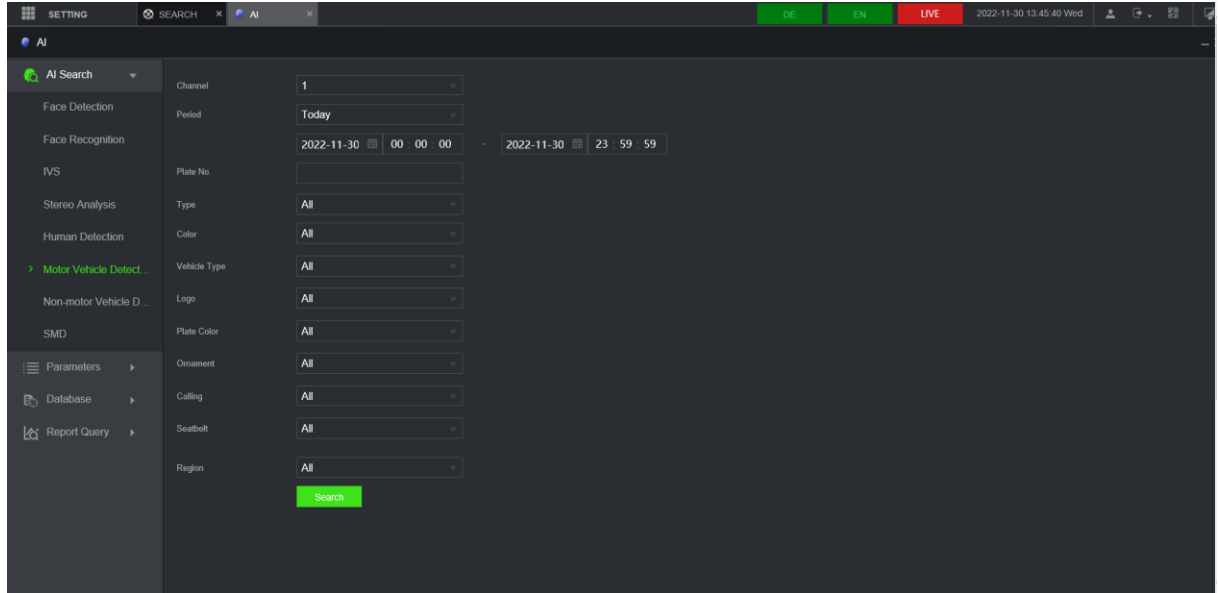

The search result is shown as a list with preview display (top right).

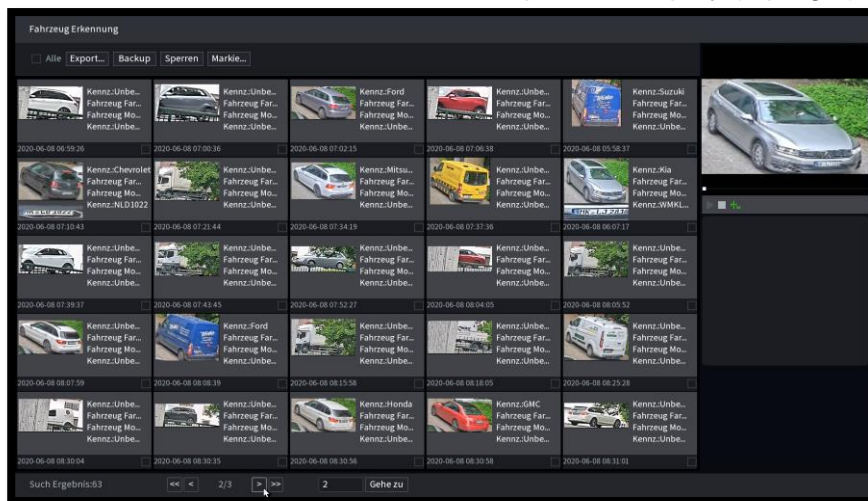

Select a preview image and double-click on the image to switch to full-screen mode and display more information.

### 6.3.1.6 Non-motorised vehicles

By setting appropriate filter functions, you can search specifically for non-motorised vehicles (two-wheelers, trikes, bicycles and visually related objects) with certain characteristics.

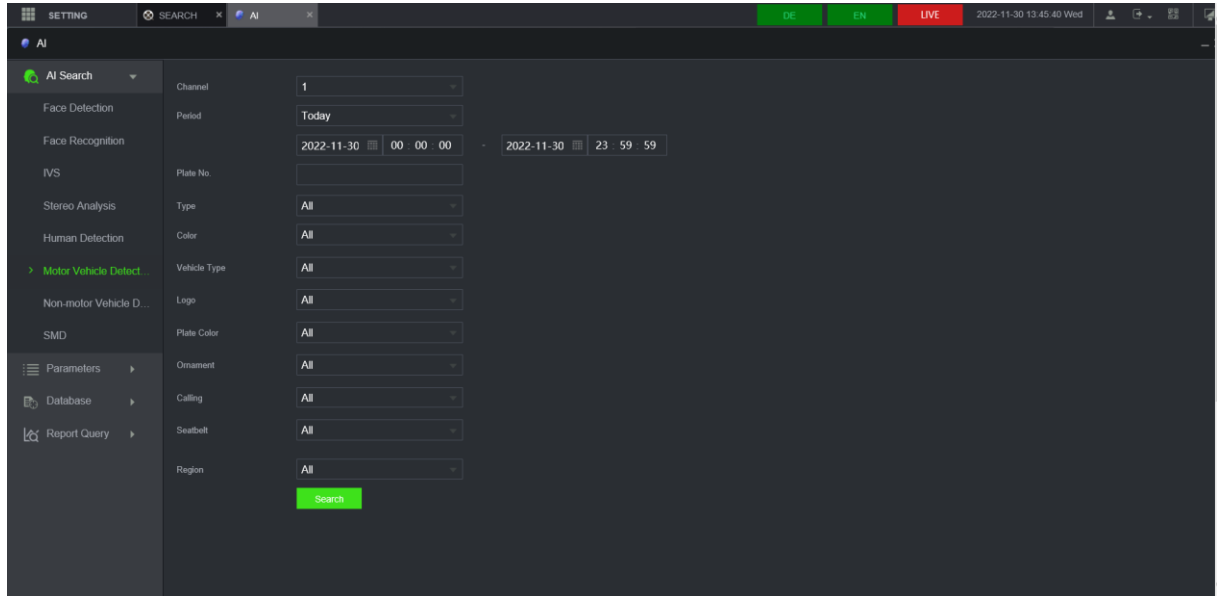

**Note:** When filtering, consider possible deviations caused by e.g. IR night vision recording, shadows, multi-colour, insufficiently detailed images.

### 6.3.1.7 Census of persons

The evaluation of the people count is done channel by channel and can be displayed as a histogram or as a polygon graphic. The time period can be selected via start time and end time. In this way, the visitor numbers of days/weeks/months can be compared with each other.

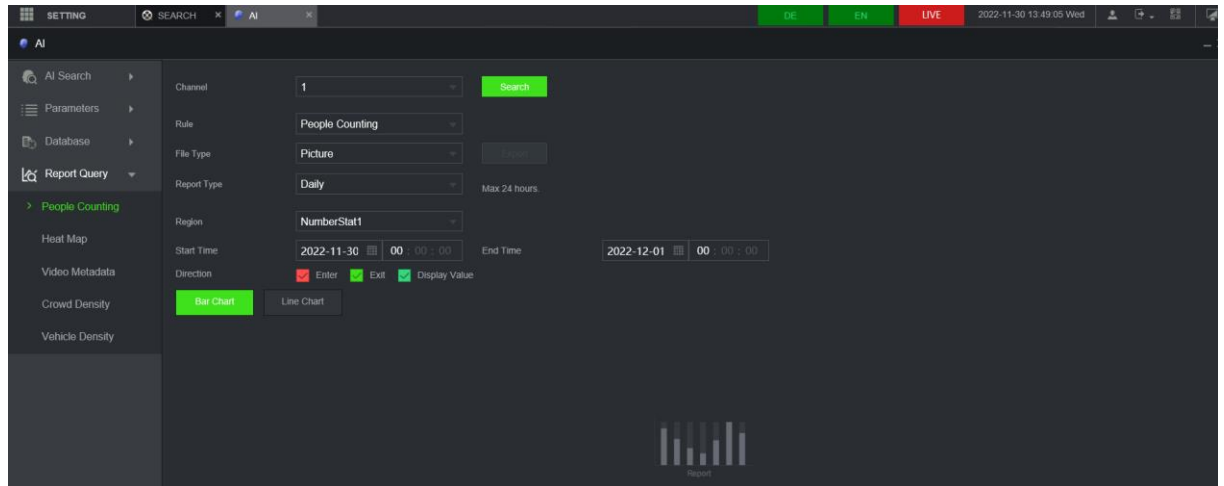

### 6.3.1.8 Heatmap

The heat map shows the respective area frequency. This function observes the movements in a scene to determine the frequency. Areas with a lot of movement are shown in red, areas with little movement in blue. The evaluation can be done day/week related.

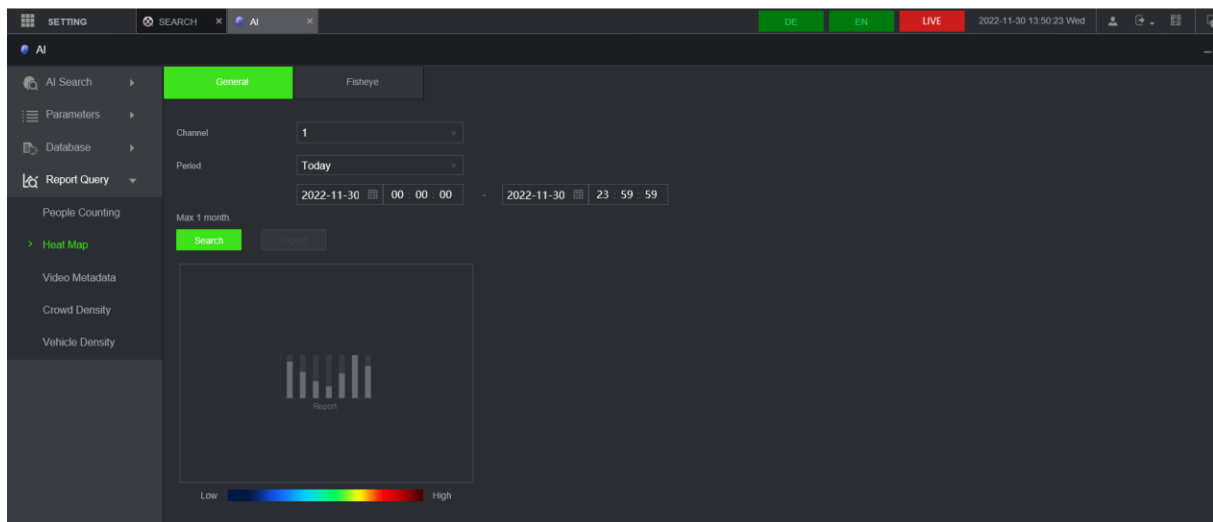

## 6.3.2 Main menu → AIVA → Parameters (Camera Remote Setup)

You can configure event detections of the cameras via the recorder using the parameter settings. Note that the recorder itself does not necessarily provide all parameters and settings that the individual cameras may allow. In order for the parameterisation to be supported, the firmware and functions must be compatible in order to function correctly.

### 6.3.2.1 IVA Plan

The IVA plan reflects the IVA settings of the BURG-GUARD cameras. Select here the IVA that the camera should perform on the current live image.

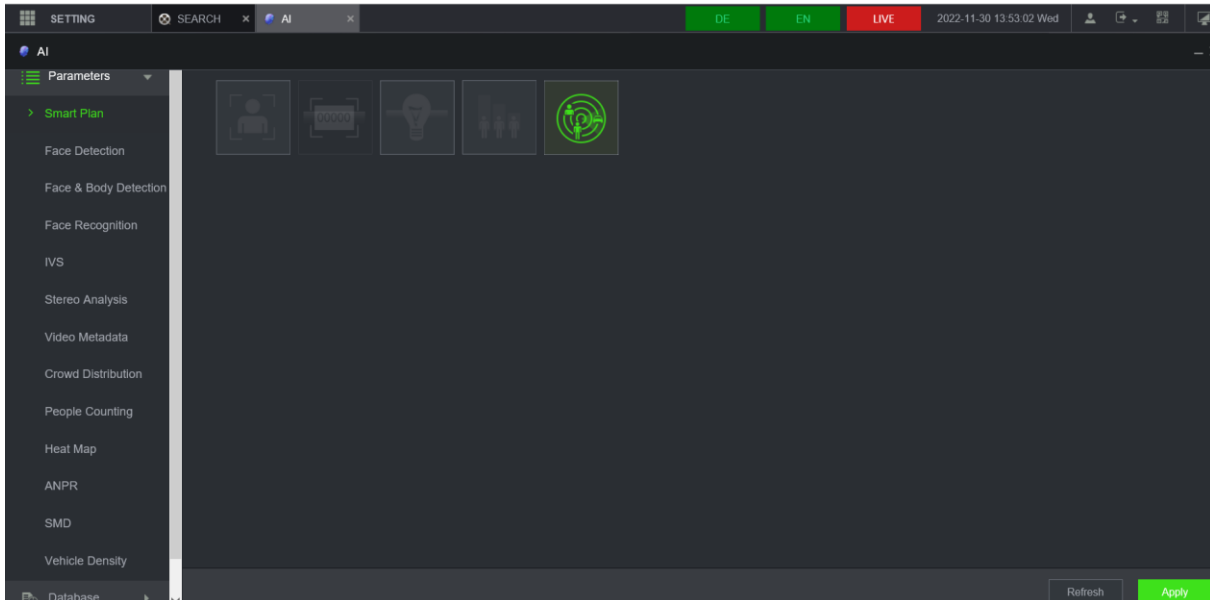

The plan also shows which IVA functions, depending on the camera, can be executed in parallel (e.g. tripwire, zone detection, heat map) and which cannot.

Note: Please refer to the manual of the camera for further information

### 6.3.2.2 Face recognition

If the camera detects a human face in the video image, an alarm can be generated. To do this, select the desired alarm action, e.g. e-mail notification, siren, etc.

- Place a tick next to "On" to activate face recognition.
- Check "Enable face ROI" to have the recognised face enlarged (in higher resolution).

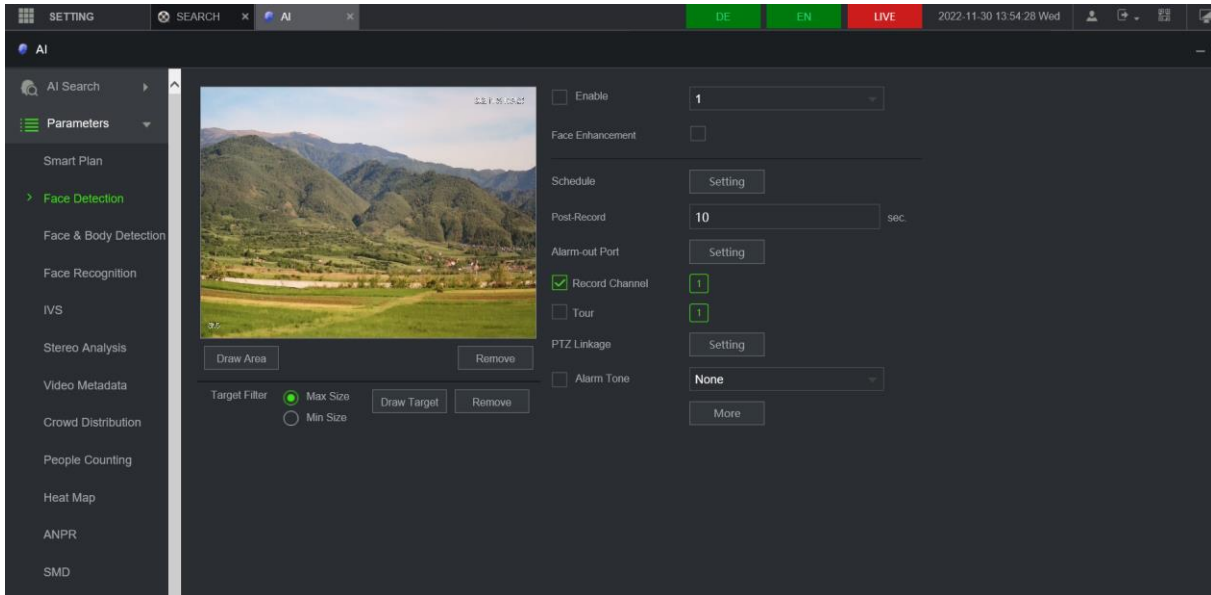

#### Hint:

The Face Detection function cannot be activated at the same time as the IVA functions. If you select face detection, please make sure that none of the channel's IVA functions are active.

Note: Please refer to the manual of the camera for further information

### 6.3.2.3 Face recognition

Face recognition requires a library of faces with which to match the data.

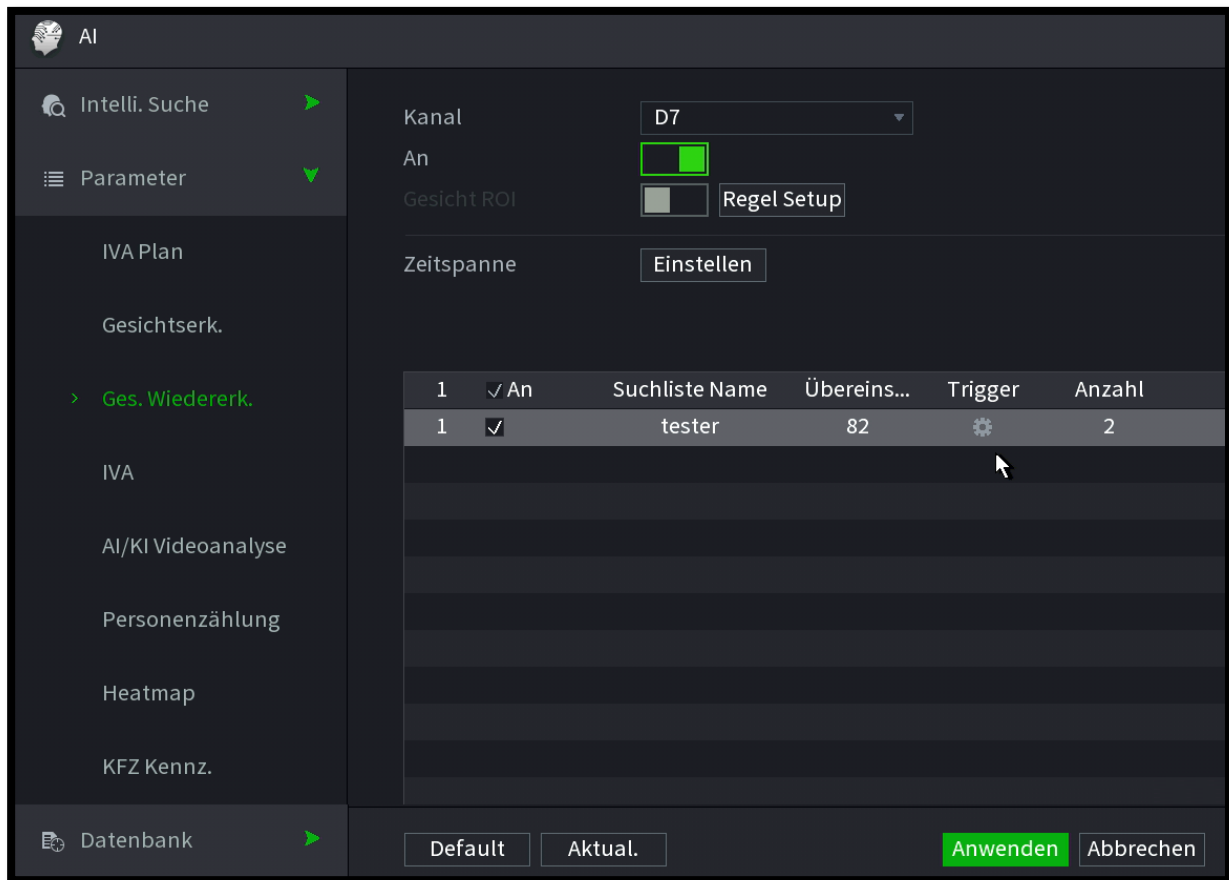

1	✓ An	Suchliste Name	Übereins...	Trigger	Anzahl
1	✓	tester	82	⚙️	2

**Note:** Please observe the applicable legal provisions, e.g. DSGVO, for the storage and collection of personal data.

#### Institution

- Activate the function of the channel in the IVA plan
- Activate the function in the tab "Ges. Wiedererkennung".
- Define the period in which the function is to be active.
- Select which libraries are to be used from the list. Note: The list is maintained in the "Database" tab.
- Confirm the selection with Apply to activate the function.

**Note:** Please refer to the manual of the camera for further information

### 6.3.2.4 IVA

Hint:

The IVA function is only available if an IP camera is connected that also has the IVA function.

IVA = Intelligent Video Analytics

The IVS provides intelligent video analytics to track, classify and analyse the behaviour of people or the change of objects.

ITS functions include virtual tripwire, trespass detection, and detection of altered scenes, or altered/missing objects, etc.

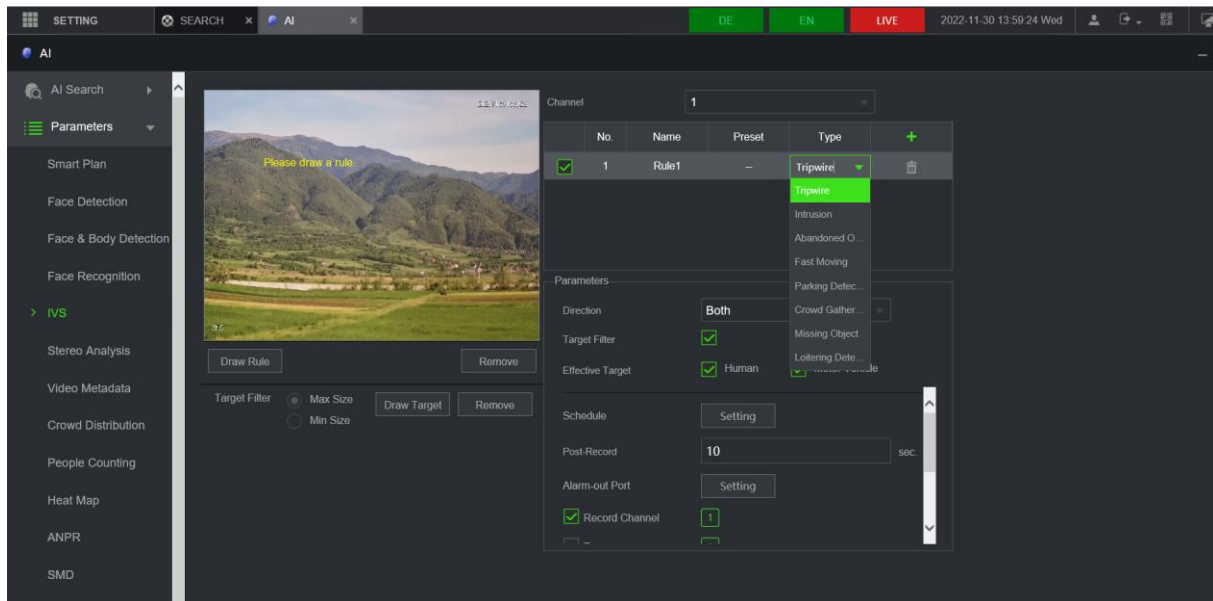

### Trip wire

You can draw a "virtual tripwire" in the video image. If an object/person now crosses this line, the virtual tripwire function is activated. In this case, for example, the video can be recorded or an alarm sound (siren) can be triggered, an e-mail notification can be sent, the PTZ function can be activated or a snapshot can be taken.

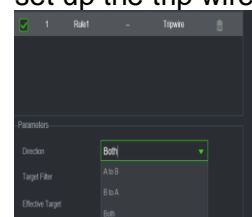

- Select the desired channel for which you want to set up a virtual tripwire and tick "On".
- Then click on "Setup" to set up the trip wire.



- A maximum of 4 trip wires (Line 1-4) can be drawn in.





- Select "Line 1" and click on "Rule Name" to assign your own name for this first trip wire (using the virtual keyboard).
- Use the direction arrows to determine in which direction the tripwire must be crossed to trigger an alarm:
- You can now define the end points of the line with the left mouse button. You can finish drawing in with a right click.
- Via  you can also define the minimum or maximum size of an object/person (you can change the sizes with the mouse). If the object/person is smaller than the minimum size or larger than the maximum size, no alarm is triggered when the tripwire is crossed. This prevents, for example, small animals crossing the tripwire from unintentionally triggering an alarm.
- Via  the settings for a trip wire are deleted.
- Click on "Save" to save the settings for this trip wire.
- Set up the remaining trip wires in the same way as described above.
- Click on "Set time full stop" to select a specific time or time period when this tripwire should be active.

Note: The function should be tested both during the day and at night. Note that there is sufficient infrared light for good detection at night.

## Zones

You can draw a "virtual zone" in the video image, e.g. to secure an area. If an object/person enters or leaves this area or both, the video can be recorded or an alarm sound (siren) can be triggered, an e-mail notification can be sent, the PTZ function can be activated or a snapshot can be taken.

In principle, setting up such a zone is done in the same way as setting up a tripwire.

## Object added / removed

Function detects whether an object has been removed / added from the scene area.

## Fast movement

The algorithm is based on the detection of rapidly changing sizes and alerts when an object changes perspective size unusually quickly.

## Object protection

Similar to the zone overrun, you can draw in an area here. The difference to the zone violation is that the time factor plays a role in object protection. An alarm is generated as



soon as an object/person has entered the area for the specified duration (in seconds) or as soon as an object/person has left the area for the specified duration (in seconds).

### **Loitering**

Similar to the zone overrun, you can draw in an area here. The difference to the zone violation is that the time factor plays a role in object protection. An alarm is generated as soon as an object/person has entered the area for the specified duration (in seconds) or as soon as an object/person has left the area for the specified duration (in seconds). In principle, setting up such a zone is done in the same way as setting up a zone overrun.

Note: Please refer to the manual of the camera for further information

### 6.3.2.5 AI/KI VA

Cameras with BURGaiva / AI/KI functions support object detection and differentiation. Targeted alarms can be triggered depending on the detected object.

Events can be triggered by e.g.

- People
- Vehicles (car, truck, ...)
- Non-motorised vehicles (bicycle, ...)

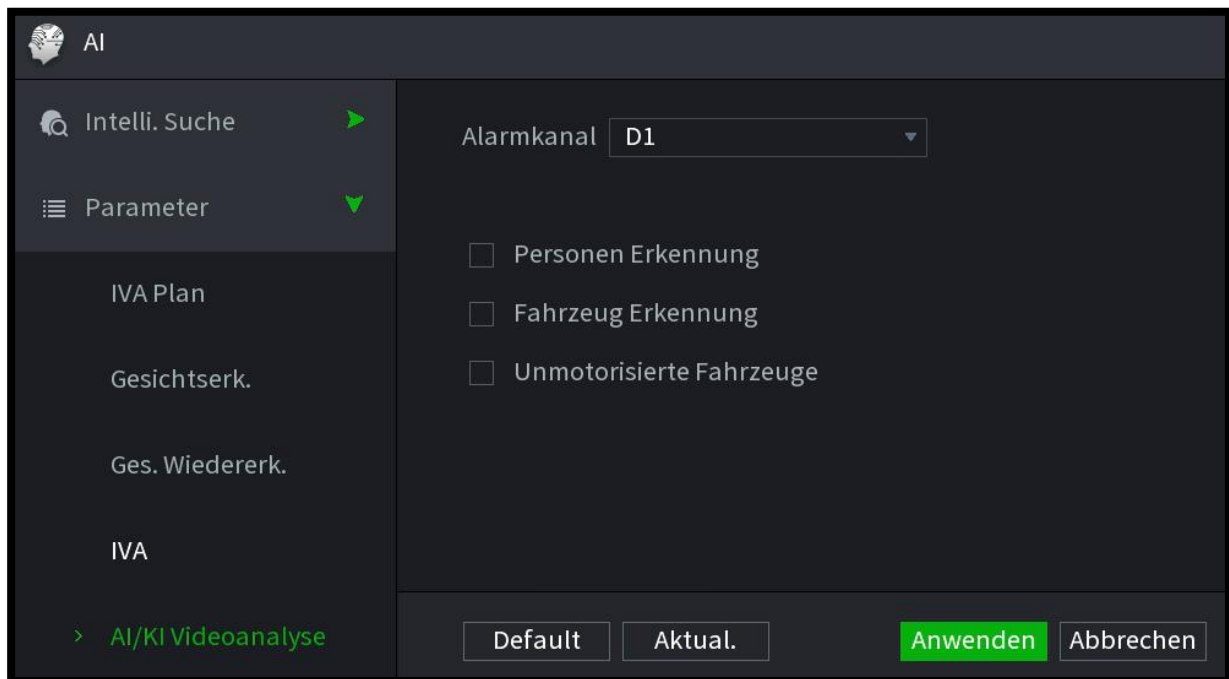

Alarms triggered by e.g. small animals, rain, moving vegetation, etc. are suppressed.

Note: Please refer to the manual of the camera for further information

### 6.3.2.6 People counting / queue

The "People counting" function supports the setup and evaluation of counting data of current BURG-WÄCHTER / BURG-GUARD camera series.

Note: The function loads the stored data from the camera that performs the people counting. The actual function is performed on the camera.

#### Facility people counting

Carry out the setting up of a people count as follows:

- Activate the "People Count" function in the "IVA Plan" of the camera channel.
- Select "People Count" in the side menu.
- Select the channel and activate the function.
- Click on "Rule Setup" to draw in the rule.

Note: Please read the corresponding chapter in the camera manual.

- Activate the in the "Alarm" settings how events are to be reacted to.
- If required, set the time period in which the function is to be active.

No.	Enable	Name	Preset	Type	
1	<input checked="" type="checkbox"/>	NumberStat1	-	People Co...	

- Click on "Apply" to apply the settings.

Note: Please refer to the manual of the camera for further information

## Queue setup

Perform the setup of a queue function as follows:

- Activate the "People Count" function in the "IVA Plan" of the camera channel.
- Select "People Count" in the side menu.
- Select the channel and activate the function.
- Select the area in which the queue is to be checked.

Note: Please read the corresponding chapter in the camera manual.

- Set the alarm type
  - Waiting pers. = number of people waiting in the queue
  - Queue time = time spent in queue
- If required, set the time period in which the function is to be active.
- If necessary, set which audio announcement or which siren/alarm I/O is to be switched when the event occurs.

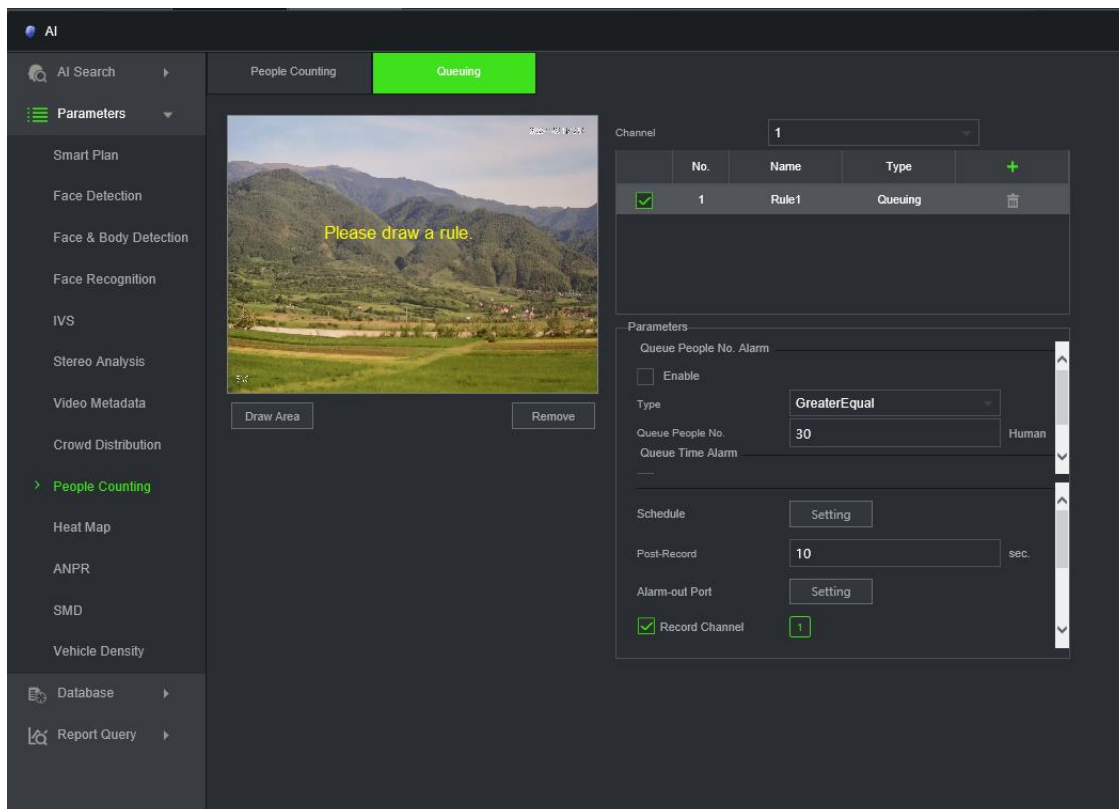

- Click on "Apply" to apply the settings.
- Note: Please refer to the manual of the camera for further information

### 6.3.2.7 Heatmap

#### Institution

Perform the heat map setup as follows:

- Activate the "Heatmap" function in the "IVA Plan" of the respective camera channel.
- Then select "Heatmap" in the side menu.
- Select the corresponding channel in the drop-down menu and tick the box to activate the function.
- Set up a schedule for the corresponding channel when the function should be activated.
- Click on "Save" to apply the settings.

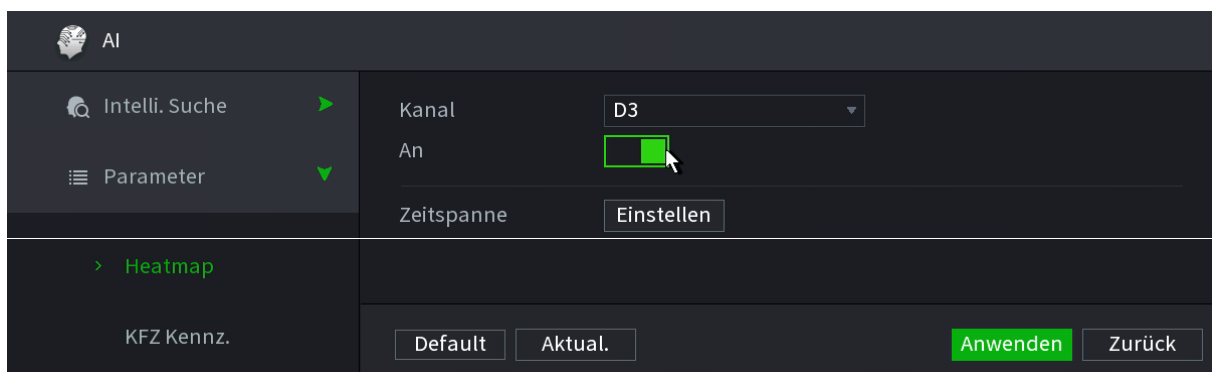

Note: Please refer to the manual of the camera for further information

### 6.3.2.8 Vehicle number plate recognition

You can set up a car licence plate recognition camera in this menu. Furthermore, entries in the blacklist and whitelist can be added, edited or deleted under "Database".

#### Setting up the number plate recognition

- Activate the function
- Assign a name for the application and draw the detection line and detection area in the live image displayed.
- Then specify which actions are to be triggered when a licence plate is recognised. Save the settings by clicking on "Apply".

Note: Test the settings during the day and night and make any necessary adjustments.

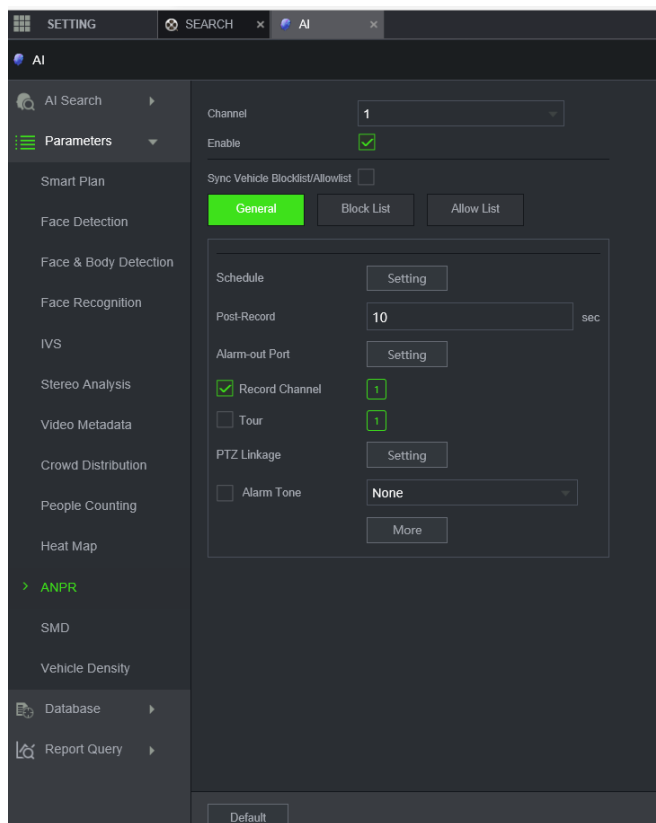

**The blacklist and whitelist are set up under "Database".**

- In the "B&W List" submenu, indicators can be added to the blacklist and whitelist.
- Enter the indicators without hyphens or teaching marks.
- Note: No guarantee can be given for correctly recognised number plates. Scene, lighting conditions, dirt and grime etc. can greatly influence the evaluation.
- If you set the view mode to "Vehicle number plate", you can display the list of the last/currently recognised number plates in the live image.

### Application example with two barriers

In the example shown below, two barriers are opened independently of each other. The management of the cameras and blacklist/whitelist entries is done via the SNVR recorder.

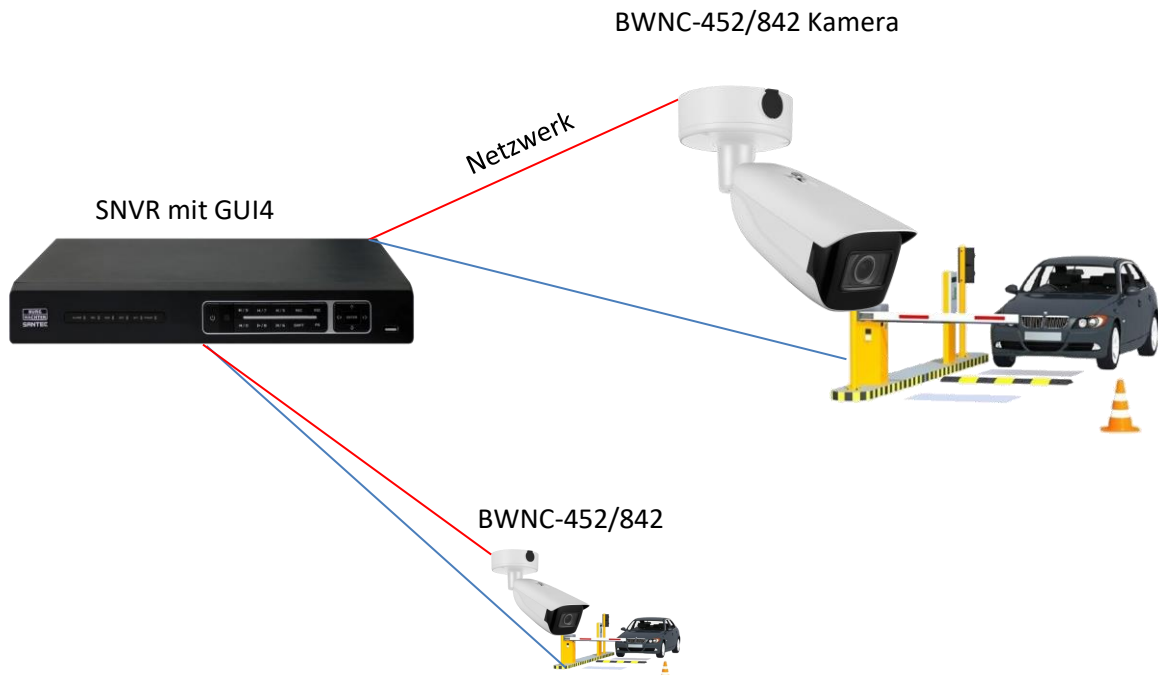

### Settings

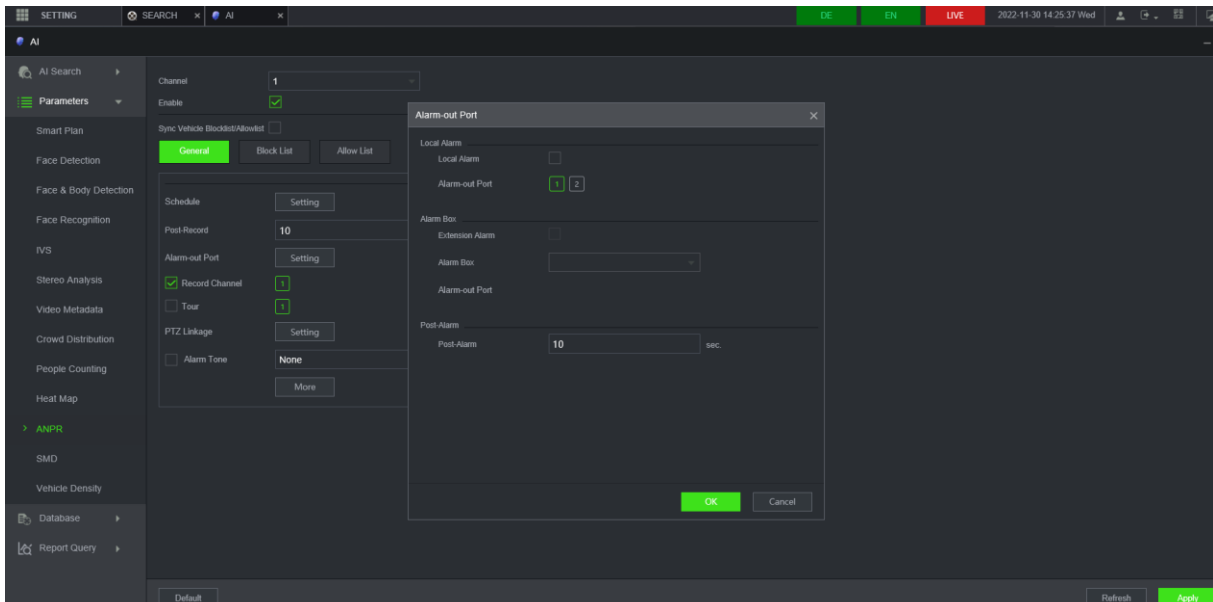



## 6.4 Main menu → Alarm(s)



### 6.4.1 Main menu → Alarm(s) → Alarm Info

In the menu item Alarm Info you will find the list of all alarms that have occurred (up to 1,000 entries).

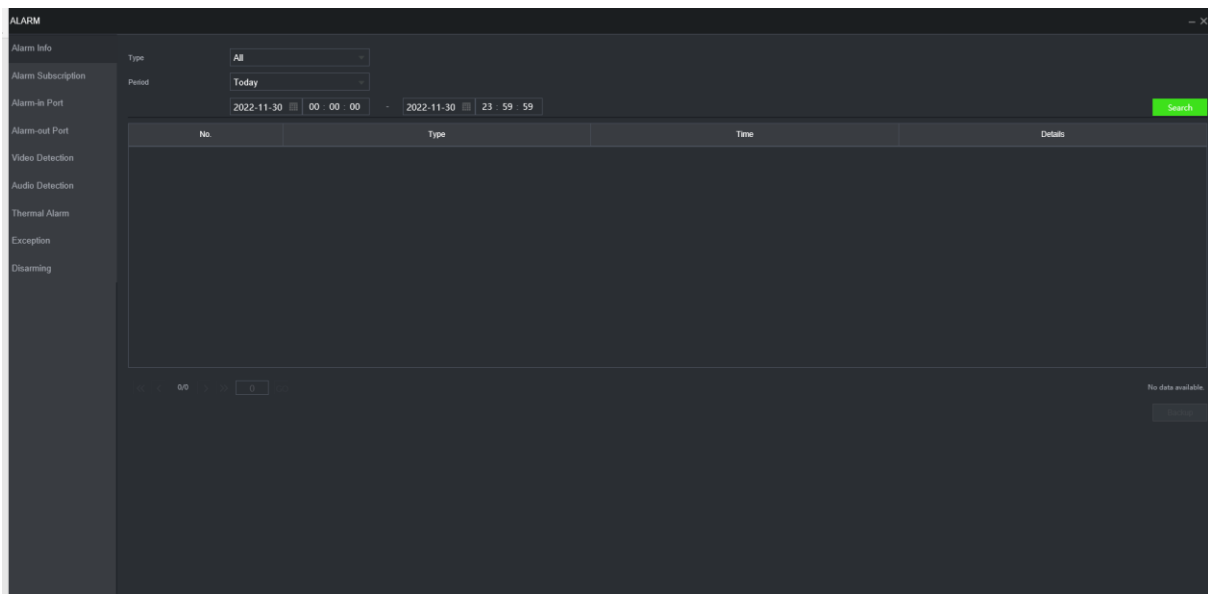

#### Search

To display specific entries in the history, select the type and the start and end time of the event and then click on the "Search" button.

#### Backup

To save the displayed entries, you can store them as a backup on a USB stick, for example.

#### Info

You can view more details about the entry via the Info button.

### 6.4.2 Main menu → Alarm(s) → Alarm

Here you will find all currently active alarms. In the example: Channel 4 - Detected movement

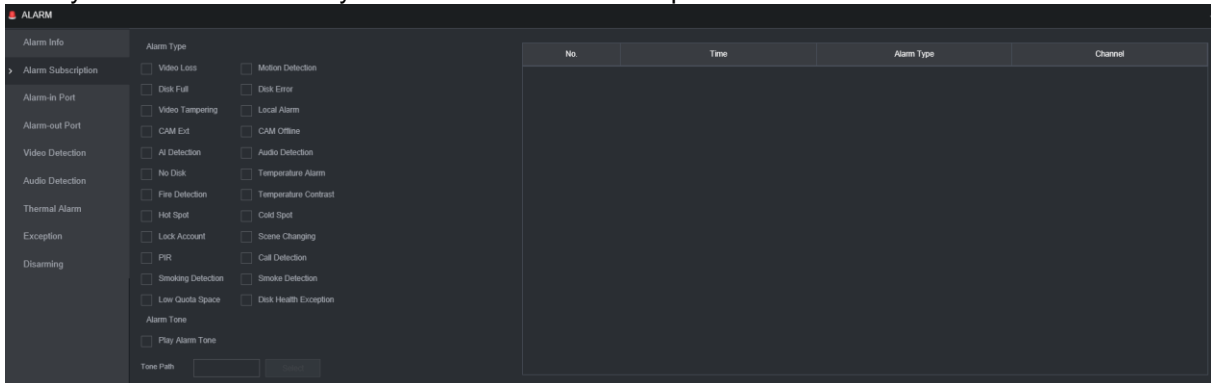

### 6.4.3 Main menu → Alarm(s) → Alarm input

In the alarm input administration there are four tabs for the respective connections.

- Rec Input = Management of recorder alarm inputs
- Rec Network. = Managing the recorder network connection
- Kam Eing. = Management of the alarm inputs of the connected cameras
- SNC Offline. = Alarm when a channel is no longer available on the recorder.

#### Recorder Alarm Inputs

Manage here how to react to an activation of the recorder alarm input. Assign an alarm name for the respective alarm input to increase traceability.

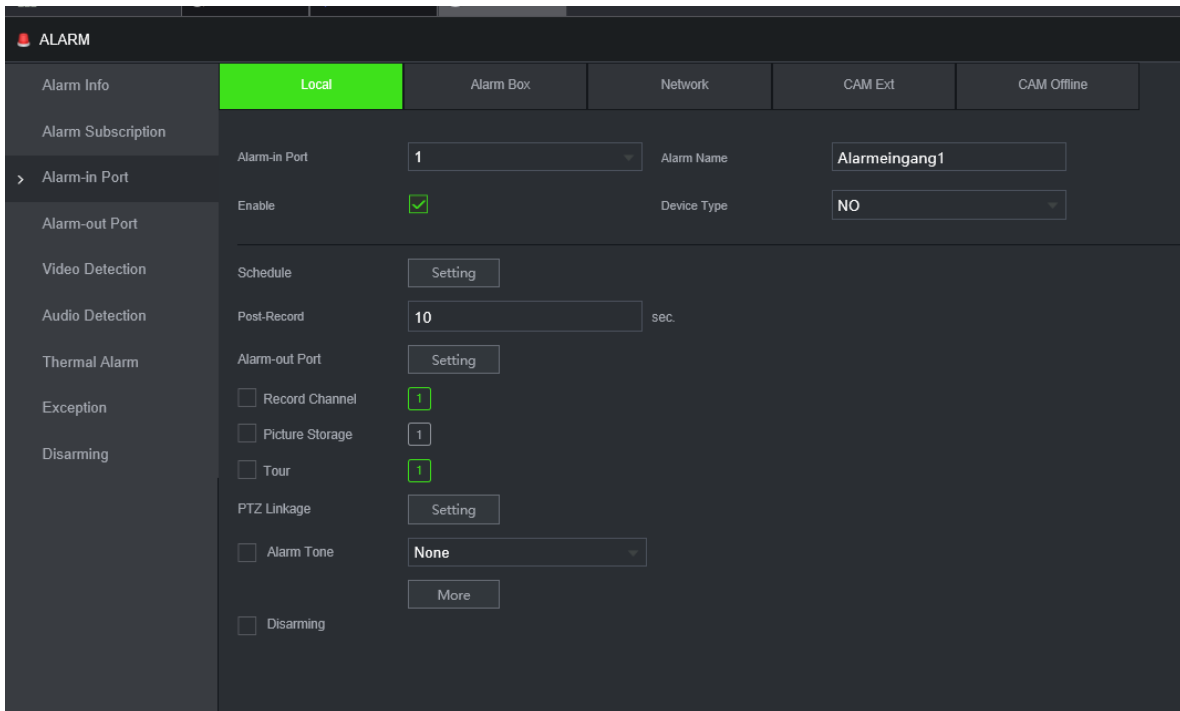



## Recorder network

Manage here how to react to an activation of the recorder alarm input via the network. Assign an alarm name for the respective alarm input to increase traceability.

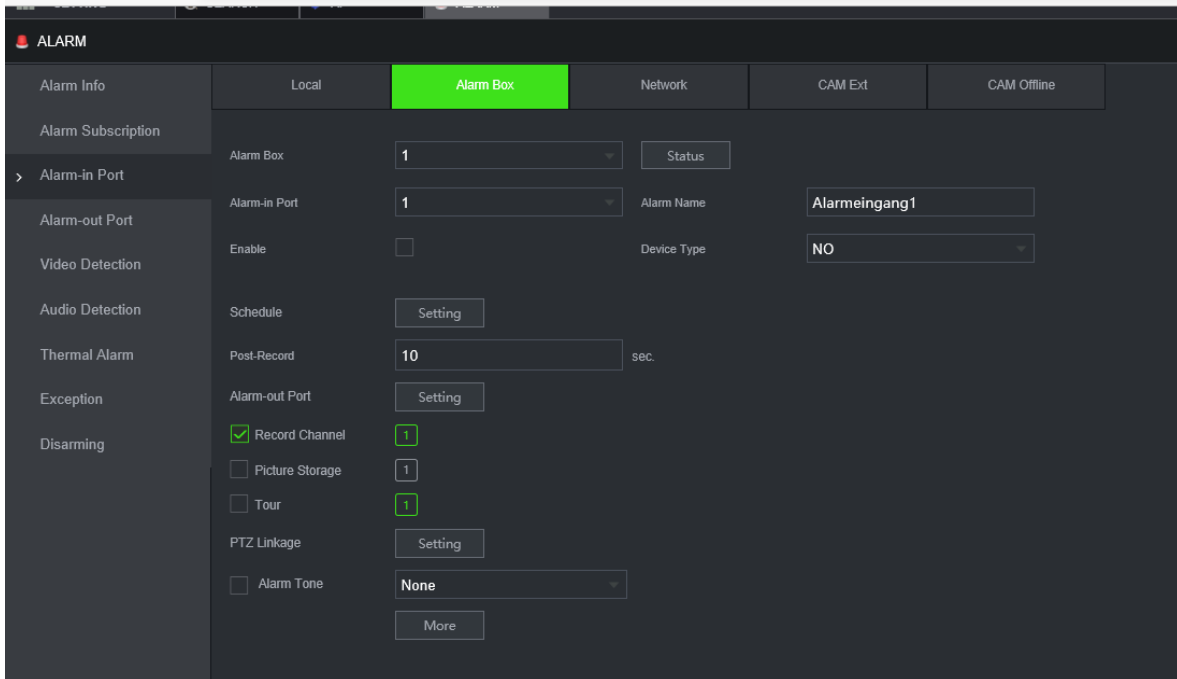

## Camera Alarm Input - Remote Alarm In

Here you can manage how the recorder should react to an activation of the camera alarm input via the network. Assign an alarm name for the respective alarm input to increase traceability.

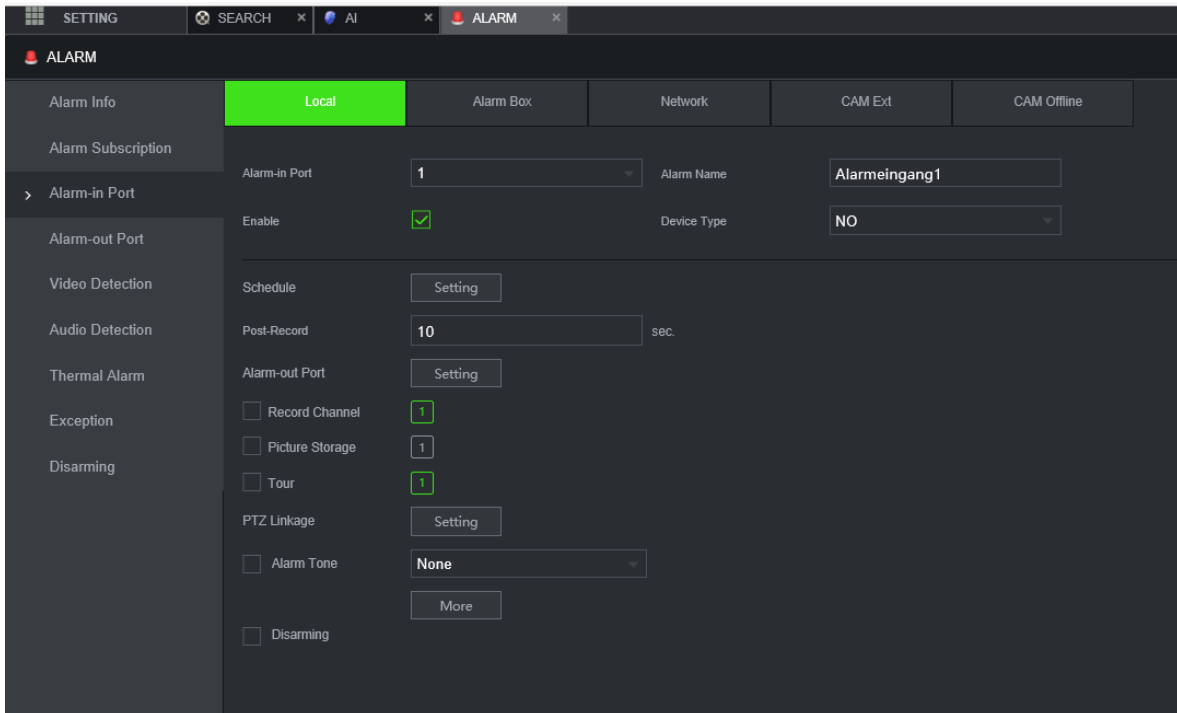

### Camera channel offline

Manage here how to react to a detected loss of connection to a camera channel.

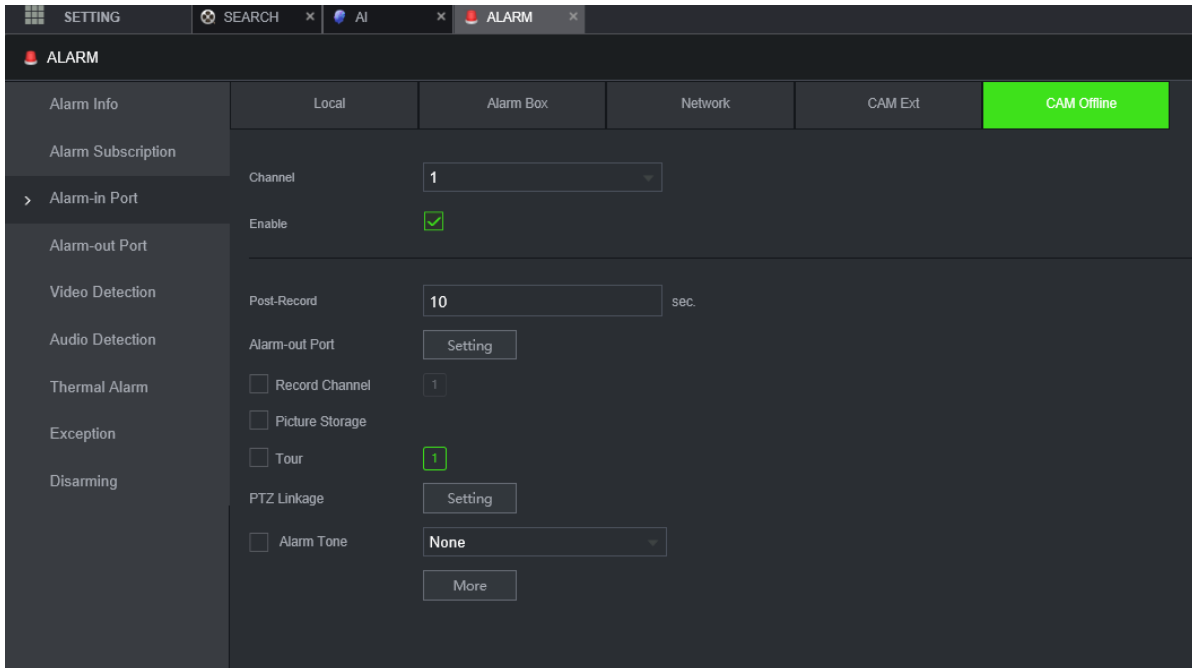

### 6.4.4 Main menu → Alarm(s) → Alarm output

In the alarm output menu, you can define when alarm outputs are to be switched, deactivate them or set them manually.

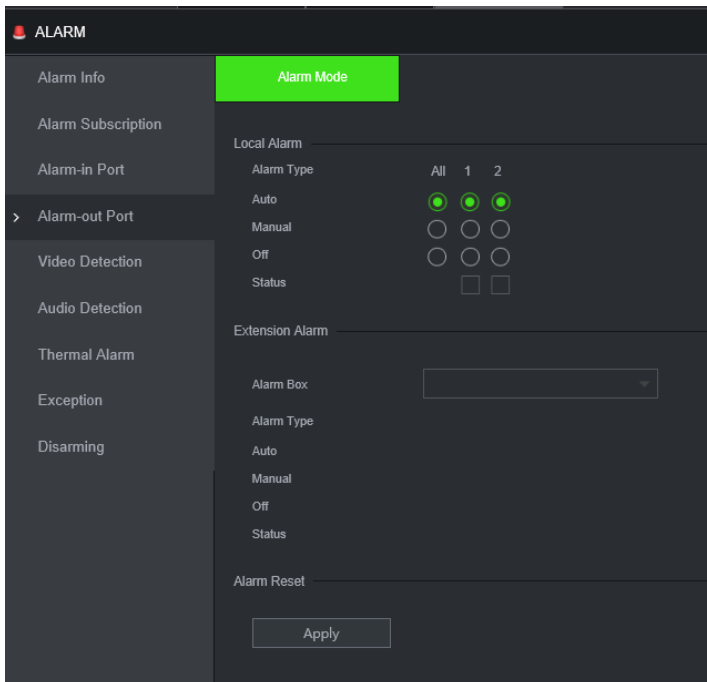

To set the status manually, click in the boxes next to "Status". If the box is ticked, the output is active; if the box is empty, the output is deactivated.



## 6.4.5 Main menu → Alarm(s) → Motion detection

The motion detection setting is channel-dependent and device-dependent. BURG-GUARD and BURG-WÄCHTER devices or ONVIF compatible devices with motion detection are supported. The setup takes place remotely on the camera system.

### 6.4.5.1 Main menu → Alarm(s) → Motion detection Motion →

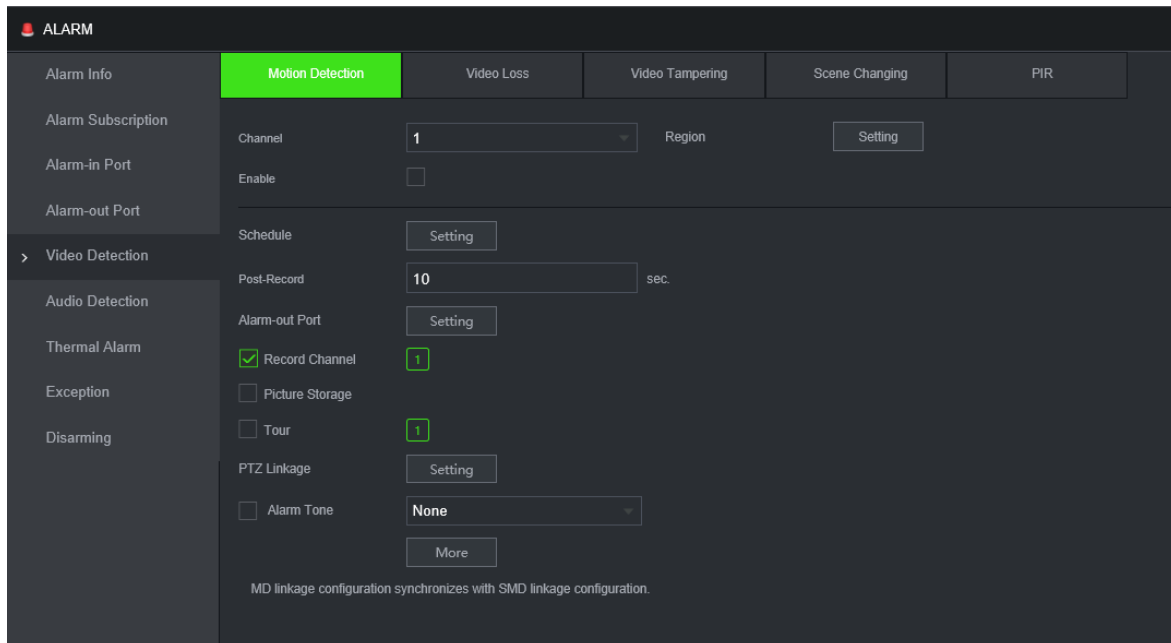

#### Set up motion detection

- I) First select the camera alarm channel for which you want to set up motion detection.
- II) Then click on Set Area
  - a. Select one of the four coloured motion detection frames
  - b. Highlight the desired area
  - c. Set the sensitivity and threshold for the selected coloured motion detection zone.
  - d. Click Save
  - e. Repeat this process for more zones if needed.
- III) Activate the function with the switch button "Bew. aktivieren".
- IV) Set the time period, dwell time before alarm triggering, post-recording (delay time).
- V) Click on Save to apply the settings.

### 6.4.5.2 Main menu → Alarm(s) → Motion detection → Video loss

Set how the system should react when a signal is interrupted. The setting is made depending on the channel.

Using the "Copy" function, at the bottom right, you can transfer the selected settings to other channels.

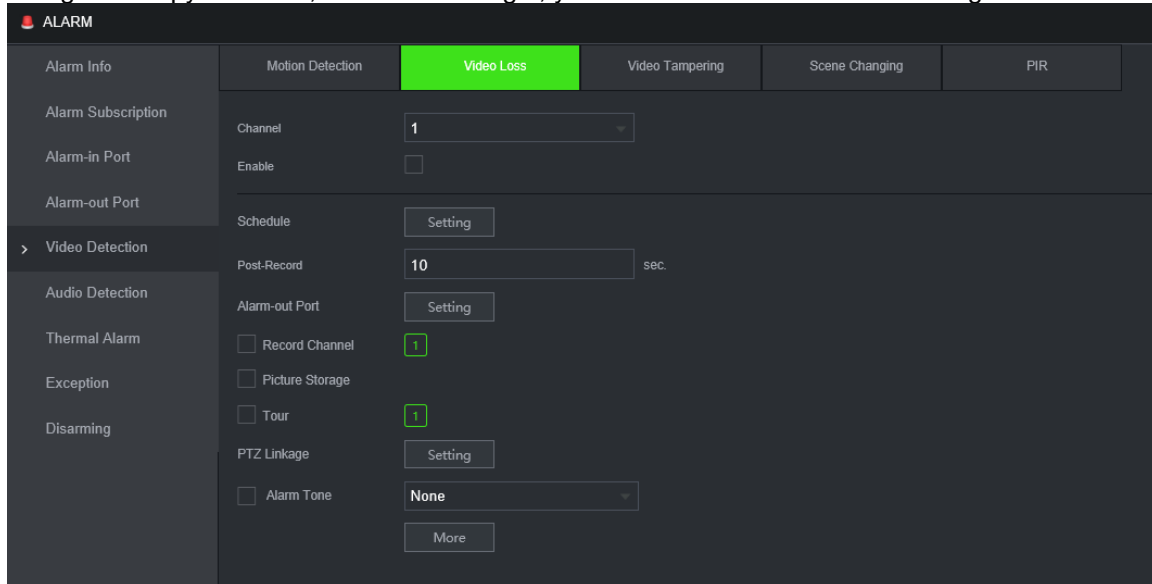

### 6.4.5.3 Main menu → Alarm(s) → Motion detection → Sabotage

Sabotage is the covering of the camera, e.g. by spraying it with paint. Activate the function to use it.

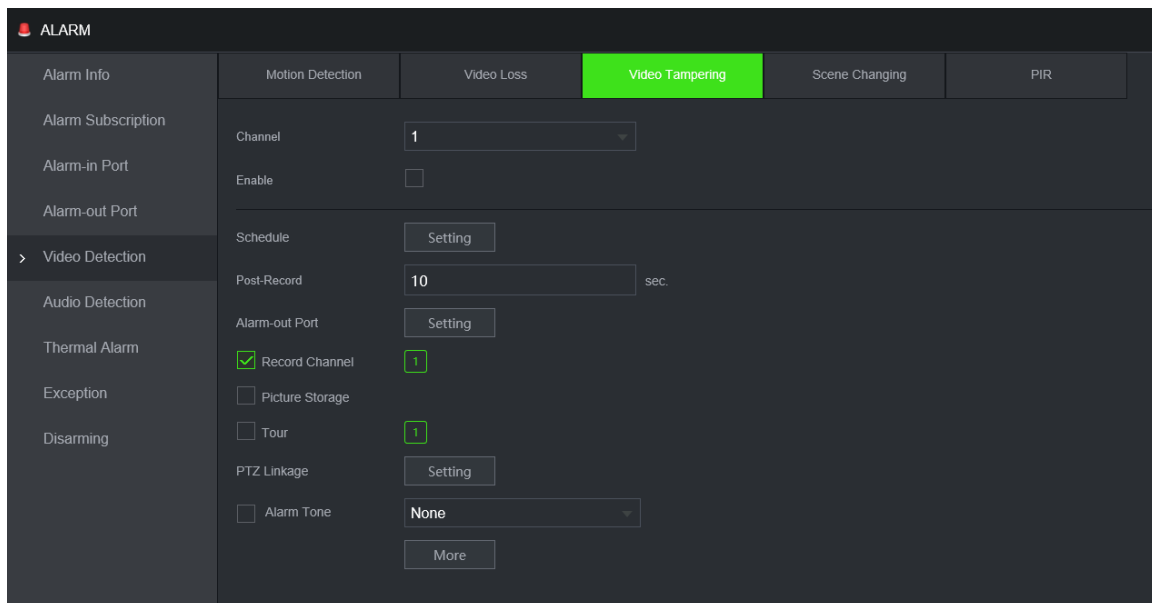

The setting is made depending on the channel. Using the "Copy" function at the bottom right, you can transfer the selected settings to other channels.



### 6.4.5.4 Main menu → Alarm(s) → Motion detection → Scenes Change

Scene change is understood as the rotation of the camera from the original position (when the function is activated). The function supports you in maintaining the camera alignment to the correct field of view.

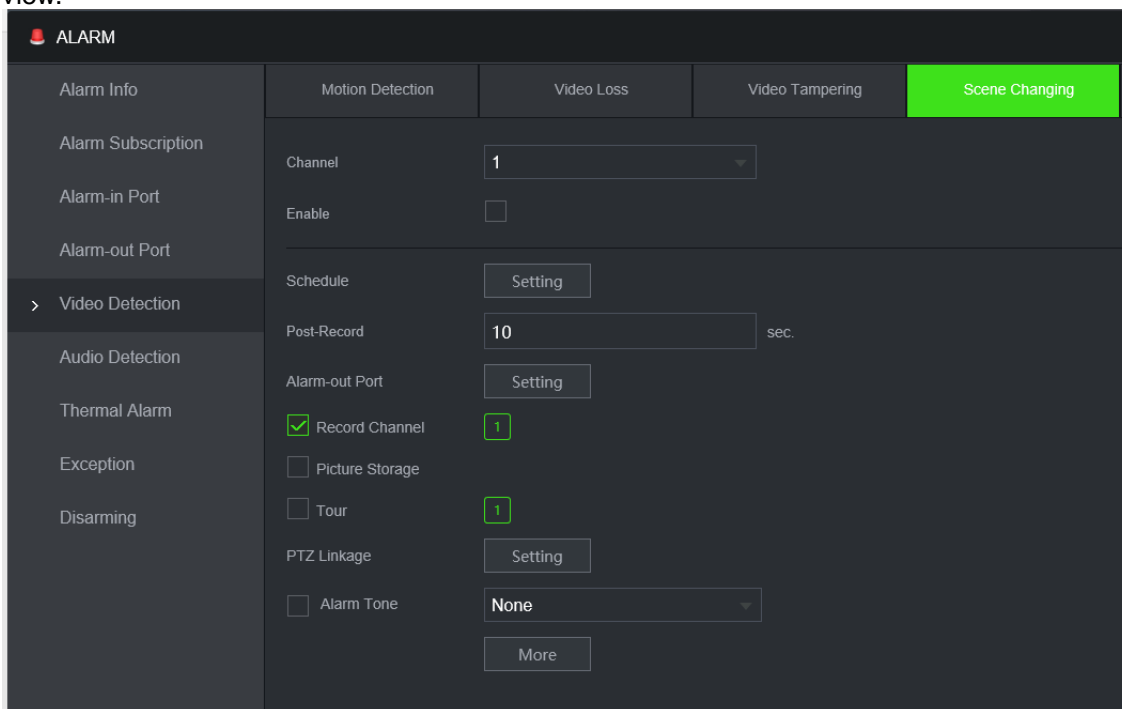

**Note:** The function is configured remotely on the camera and is therefore only applicable to supported systems.

#### Setting

After a scene change alarm has been triggered, the camera should be correctly aligned again and the function should then be reactivated.

### 6.4.5.5 Main menu → Alarm(s) → Motion detection → PIR alarm

If the connected system has a compatible PIR function, you can process the incoming alarm in the menu shown below.

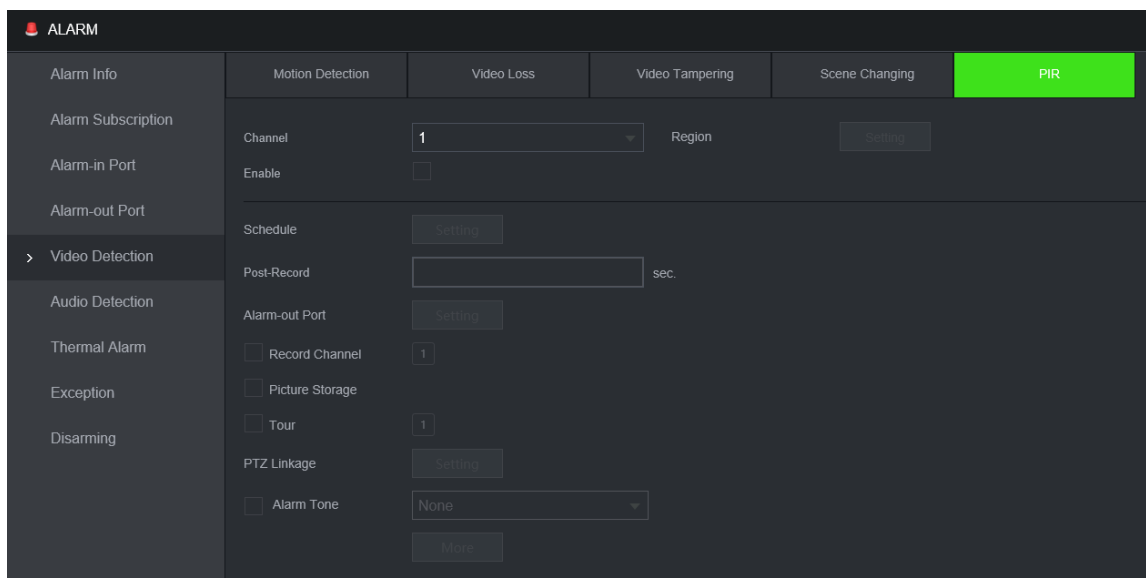

### 6.4.5.6 Main menu → Alarm(s) → Audio analysis

Using audio analysis, compatible devices with microphone or audio input can be configured remotely. Set the volume at which an alarm is to be triggered, defined via the limit value. The audio signal can be internally amplified/attenuated via the sensitivity.

The screenshot shows the 'ALARM' configuration page with the 'Audio Detection' section selected. The left sidebar lists various alarm types, with 'Audio Detection' highlighted. The main content area displays the following settings:

- Channel: 1
- Audio Exception:
- Intensity Change:
- Sensitivity: Slider set to 50
- Threshold: Slider set to 50
- Schedule: Setting
- Post-Record: 10 sec.
- Alarm-out Port: Setting
- Record Channel:  1
- Picture Storage:
- Tour:  1
- PTZ Linkage: Setting
- Alarm Tone: None
- More: Button

### 6.4.5.7 Main menu → Alarm(s) → Thermal image AI Alarms

Call Alarm and Smoking Alarm are AI features of the SWC-241RBIF series dual image thermal cameras.

Activate the desired function and set its alarm processing.

The screenshot shows the 'ALARM' configuration page with the 'Thermal Alarm' section selected. The left sidebar lists various alarm types, with 'Thermal Alarm' highlighted. The main content area displays the following settings:

- Channel: 3
- Alarm Type: Fire
- Schedule: Setting
- Post-Record: 10 sec.
- Alarm-out Port: Setting
- Record Channel:  1 2 3
- Picture Storage:
- Tour:  1 2 3
- PTZ Linkage: Setting
- Alarm Tone: None
- More: Button



**Note:** The functions depend on the IVA Plan settings.

### 6.4.5.8 Main menu → Alarm(s) → Abnormality → HDD

From the list of event types, select which alarms you want to activate and how to react to them.

**Note:** If no hard disk is installed in the system, the following selections should be disabled:

- No HDD
- HDD faulty

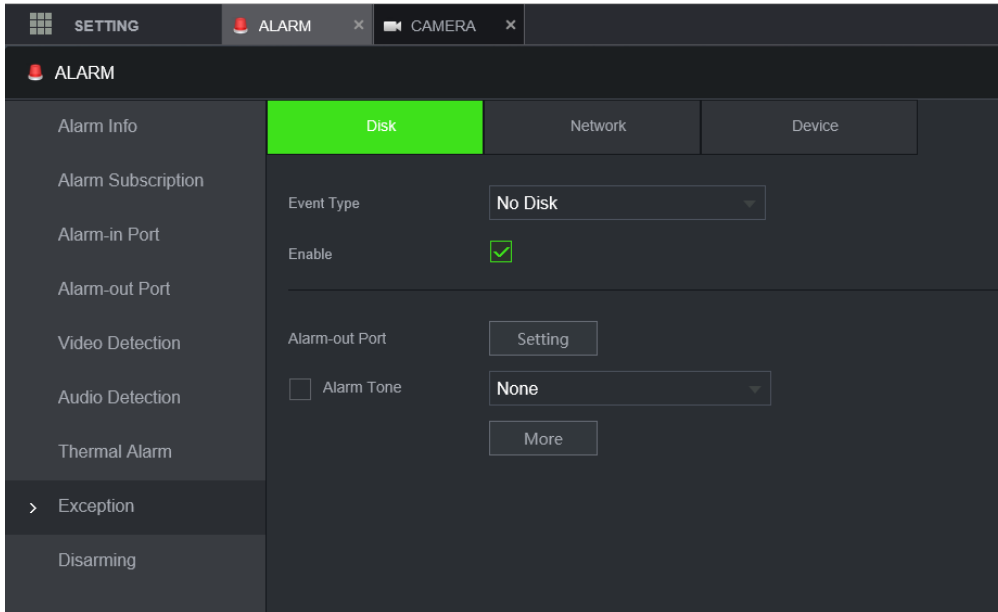

Click on "Apply" to apply the settings.

### 6.4.5.9 Main menu → Alarm(s) → Abnormality → Network

Select the events you want to activate from the drop-down list and activate the function and the event to be triggered in each case.

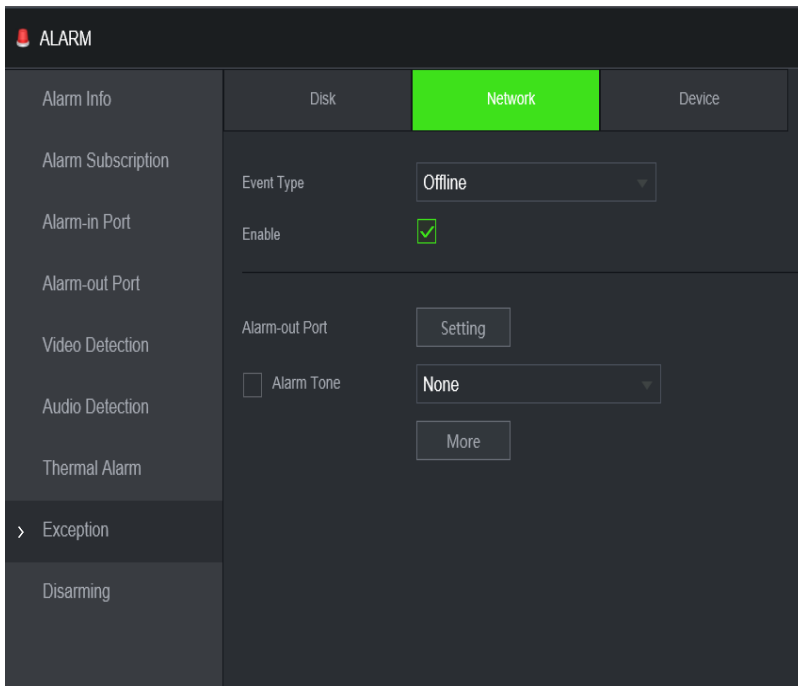

### 6.4.5.10 Main menu → Alarm(s) → Abnormality → User

In this menu you can set how to react to repeated, illegal, accesses to the system and how long the blocking times are.

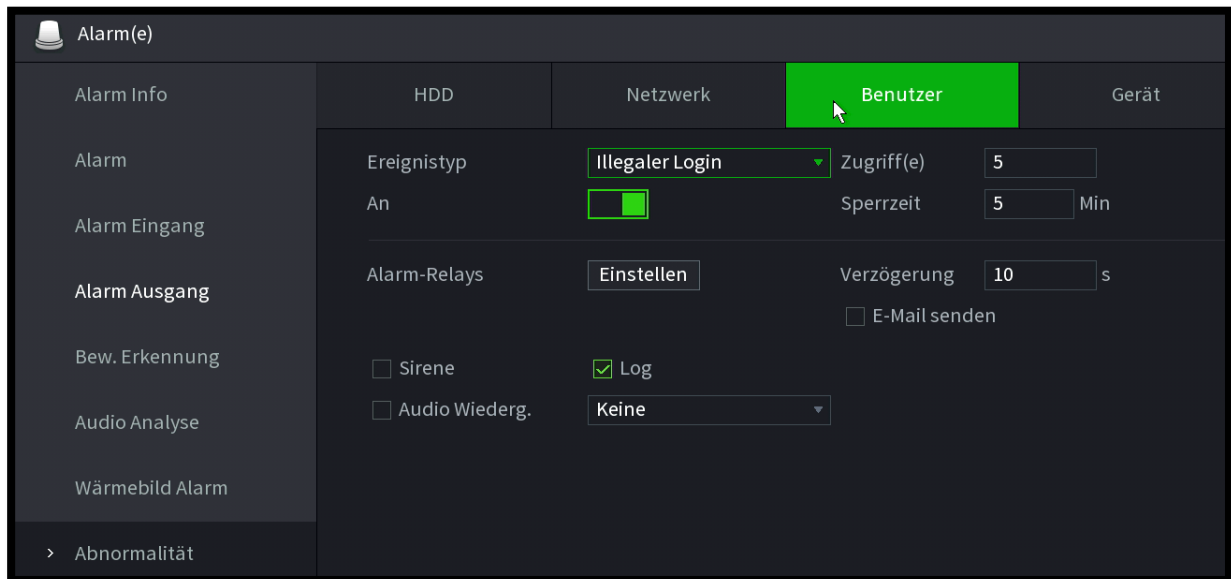

### 6.4.5.11 Main menu → Alarm(s) → Anomaly → Device

Set recorder-specific event types here, e.g. fan tempo.

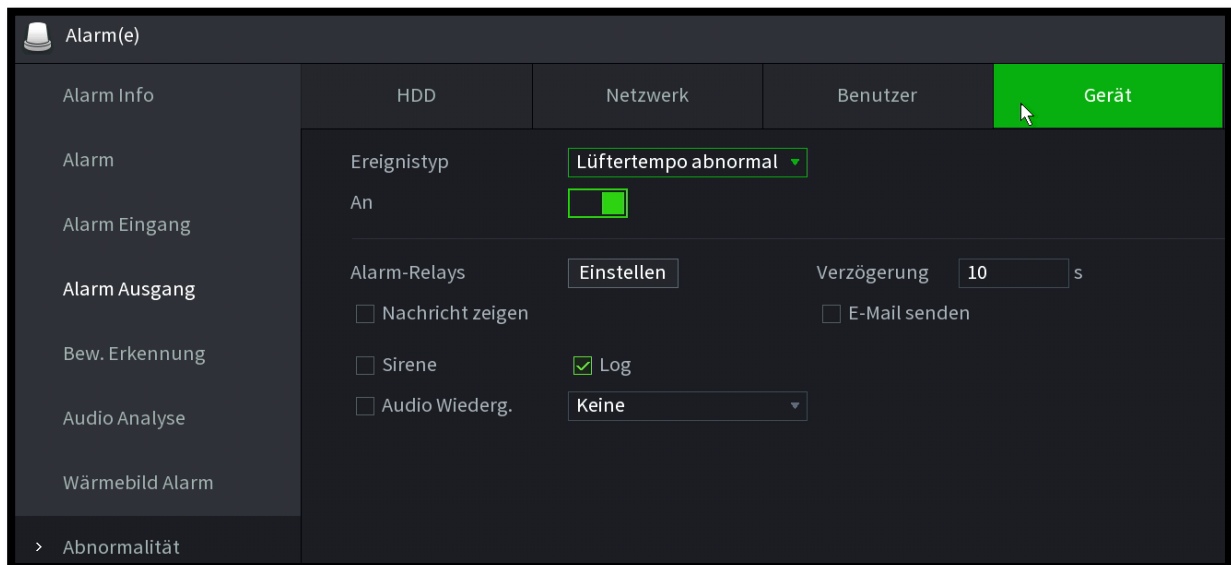

## 6.5 Main menu → POS (Point of Service)

### 6.5.1 Main menu → POS (Point of Service) → POS Search

Using the POS search, you can search for events within a time interval and for transaction processes.

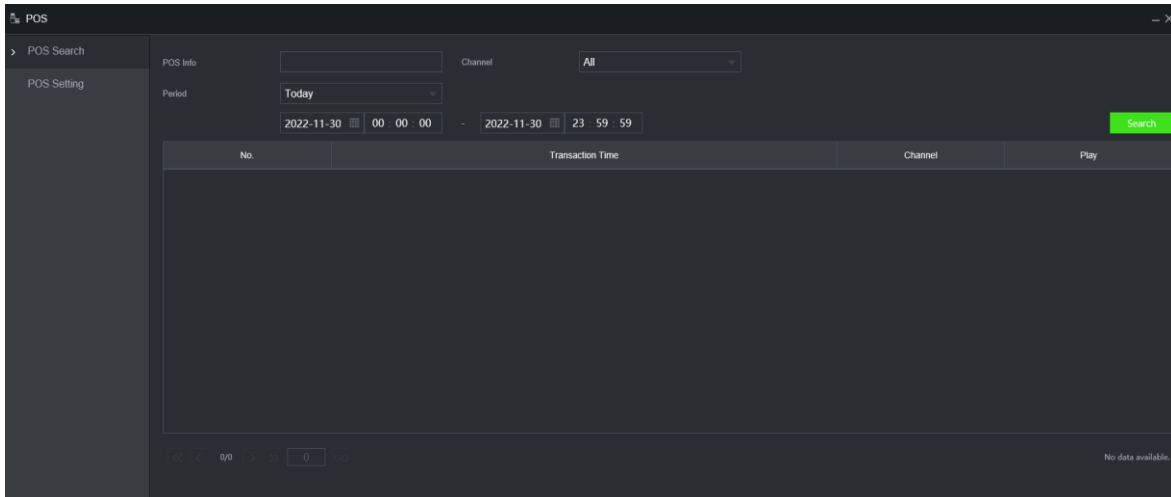

### 6.5.2 Main menu → POS (Point of Service) → POS Setup

With POS you can display data, e.g. from your cash register system, live in the camera image or search for it later in the recording. This function is often used for cash register systems, scales and filling devices.

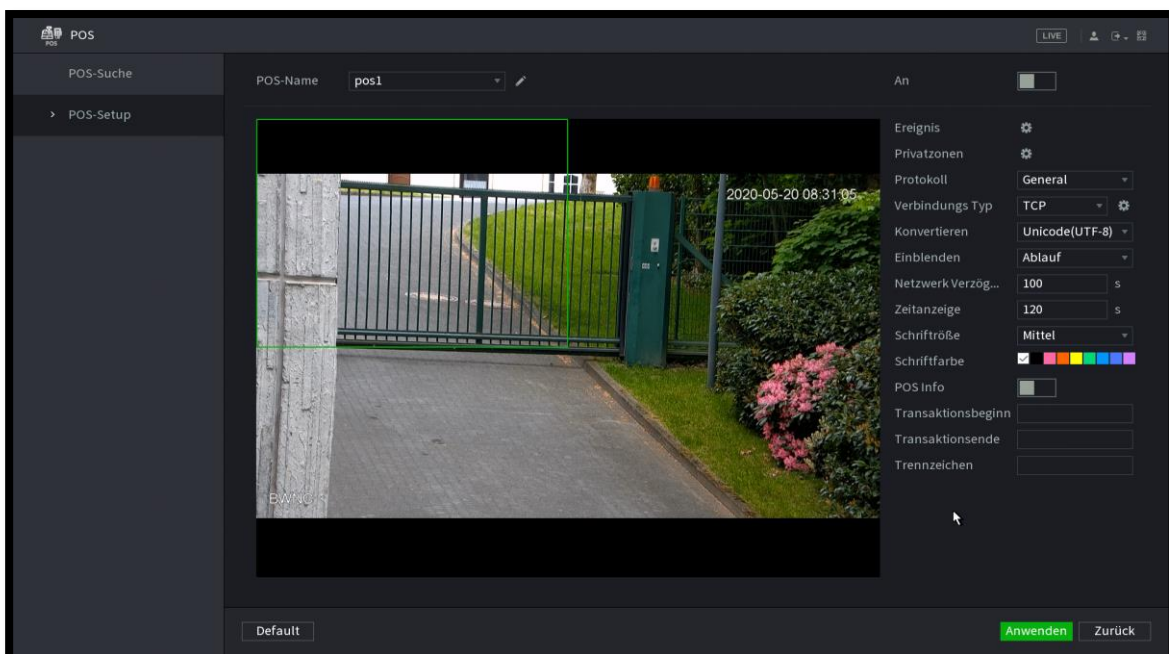

To show only selected data in the live image, you can adjust the protocol in the lower image segment. Adjust the transaction start, transaction end accordingly and also enter a separator.

Talk to the supplier of your cash register system to get detailed information about their cash register protocol.

## 6.6 Main menu → Application

### 6.6.1 Main menu → Application → Log

The log lists all events detected by the system. The log shows the history of the system settings and events.

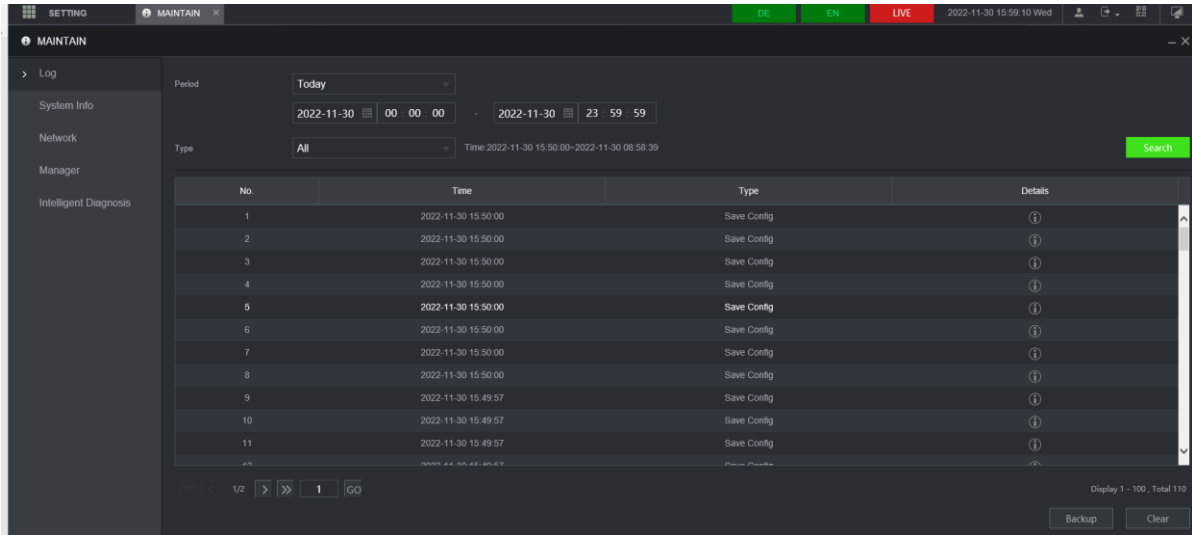

### 6.6.2 Main menu → Application → Information

#### Version

Shows the system information. Please keep this information available for service cases and send it by e-mail in case of questions.

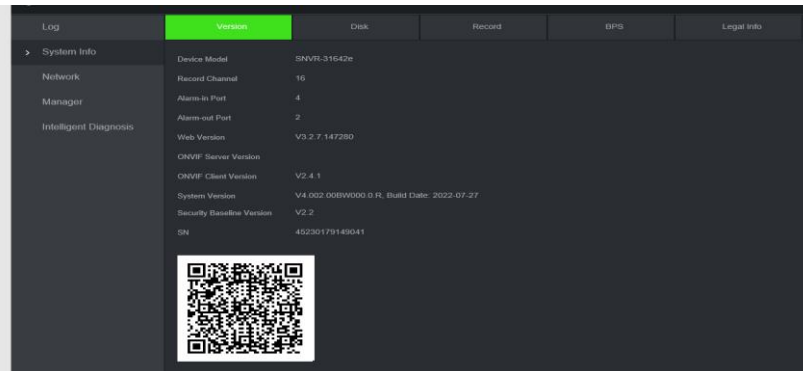

#### HDD

Here you will find hard disk information

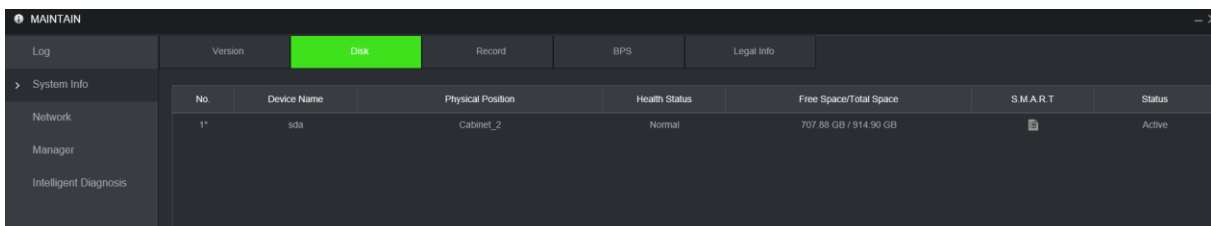

#### BPS

Display of the current resolution / network traffic on the internal PoE switch.



MAINTAIN

Log	Version	Disk	Record	BPS	Legal Info
> System Info					
Network	Channel	Kb/S	Resolution		
Manager	1	4124	3840*2160		
Intelligent Diagnosis	2	4125	1920*1080		
	3	1133	1280*960		
	4	0	--		
	5	0	--		
	6	0	--		
	7	0	--		
	8	0	--		
	9	0	--		
	10	0	--		
	11	0	--		
	12	0	--		
	13	0	--		
	14	0	--		
	15	0	--		
	16	0	--		

### Status

The status shows the CPU, memory and fan information.

If required, the fan can be switched from self-adaptive (default) to permanent operation.

Anwendung

Log	Version	HDD	BPS	Status
> Information	Lüfter... Selbst-A... ▾			
Netzwerk	4200			
Systemwartung				
CPU	CPU Temper...	Speicher		
3%	Normal 59 °C	37%		
Strom				

### HDD test

Checking the hard disk and the status (SMART)

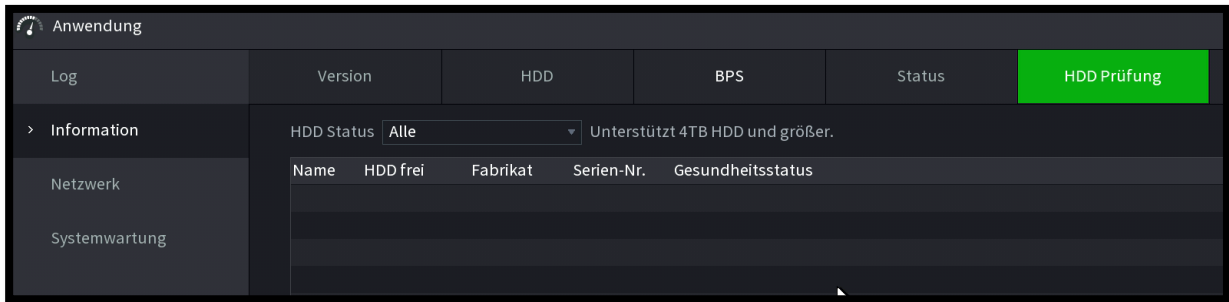

### 6.6.3 Main menu → Application → Network

This menu displays the users currently logged in.  
If an account is used by several people at the same time or people are logged in locally and via the network, the user is displayed several times.

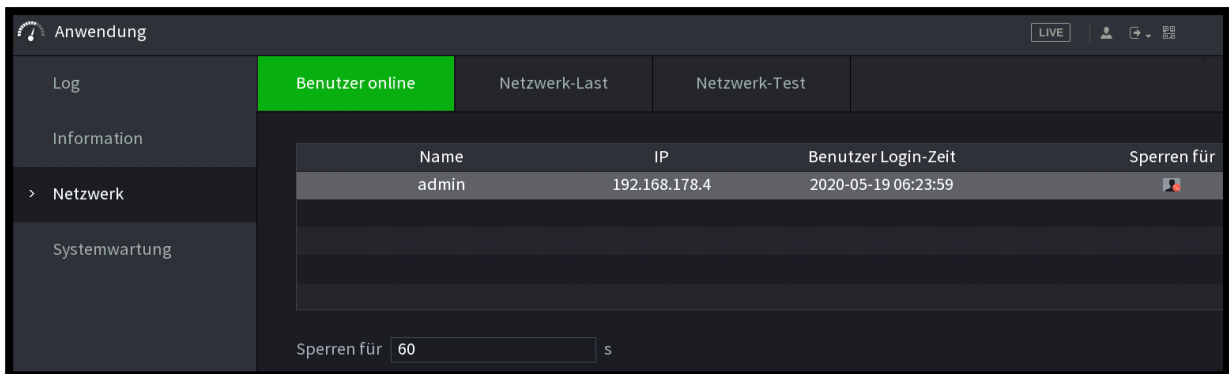

The "Block" button can be used to remove people from the system for a short period of time without deleting the account.



### 6.6.4 Main menu → Application → Network Load

In the menu shown, you can view the load of the network / PoE switch and observe changes (e.g. with VBR streaming and different movement scenarios).



### 6.6.5 Main menu → Application → Network Test

With Network Test you can test a device connection in the network via PING.

Netzwerk Test

Ziel IP:  Test

Testergebnisse

Netzwerk Paket-Mitschnitt Backup

Geräte ID:  Aktual.

Adresse:  Pfad

Name	IP	Paket-Mitschnitt Größe	Paket-Mitschnitt Backup
LAN1	192.168.178.236	0KB	▶
LAN2	10.1.1.1	0KB	▶

Alternatively, you can store package recordings on USB for service purposes. To do this, first insert the USB stick into the USB port of the recorder. Then open the function and select the directory. Then click on "Packet recording" next to the desired LAN interface / PoE switch.

## 6.6.6 Main menu → Application → System maintenance

### Car. Restart

Define on which day of the week and at what time the system should restart.

Note: A restart once a week is recommended.

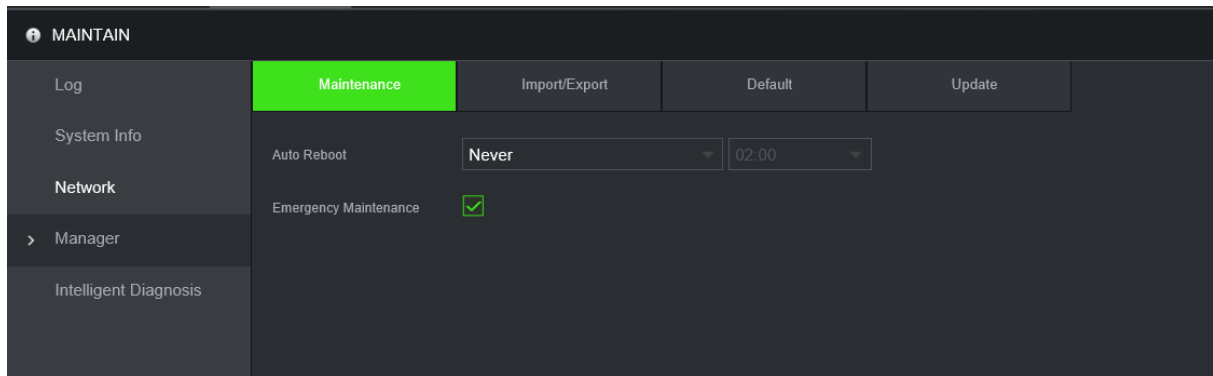

### Import / Export

Insert an empty USB stick into the USB port of the recorder. Select the file path and the file to which you want to import (export). Confirm the import (export) by pressing the corresponding button.

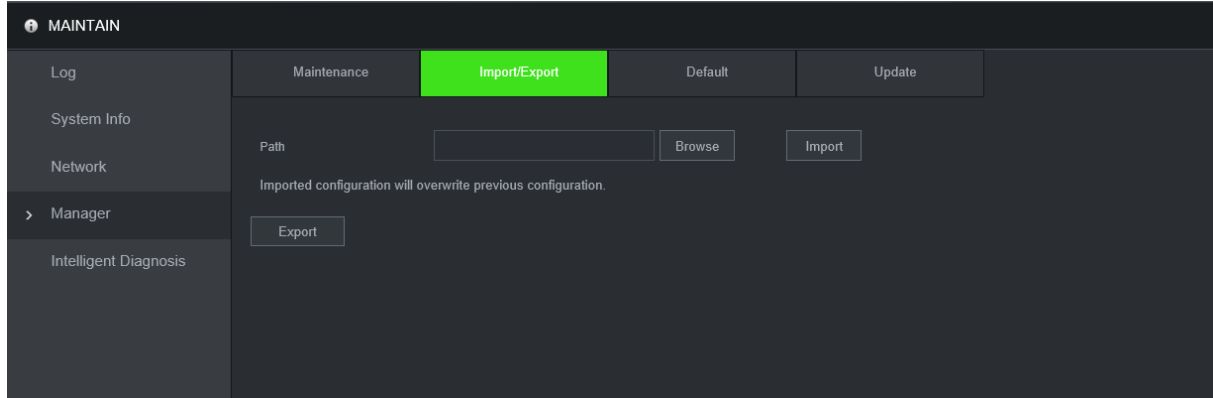

**Note:** Please note that exported system settings may be firmware version / hardware specific and cannot be arbitrarily exchanged between different versions.



## Default

To partially reset the system to factory settings, tick the individual boxes next to the function groups and click on "Apply" at the bottom right. To reset the system completely, click on "Factory setting" at the bottom left.

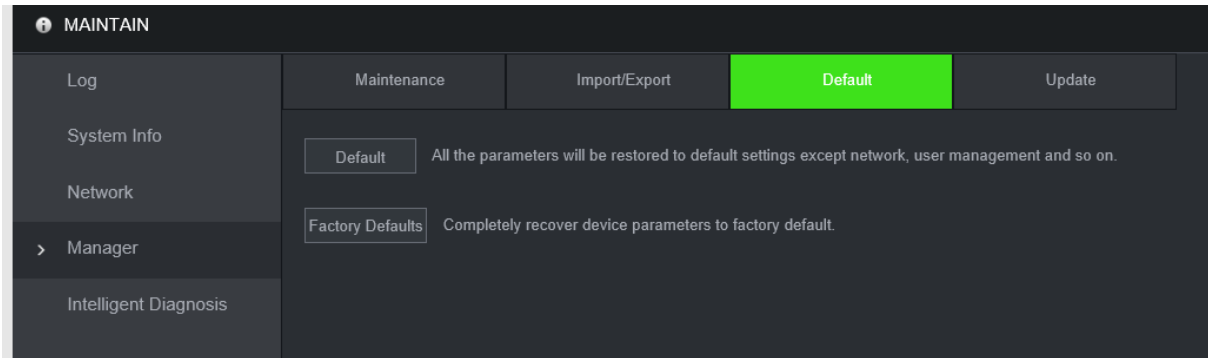

## Update

To update the system via USB stick, please download the latest firmware update to the USB stick. If you are not sure whether this is the latest firmware update, our support team will be happy to help you.

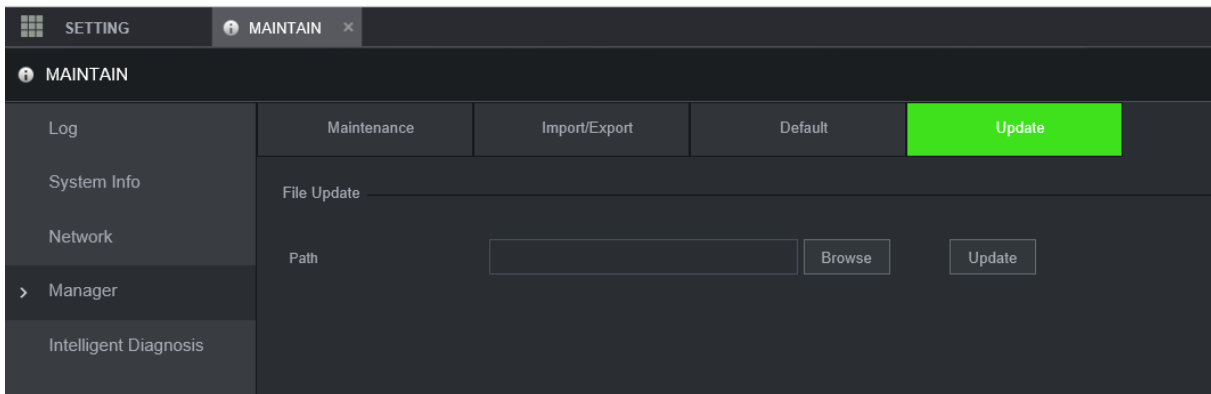

Insert the USB stick with the latest firmware into a free USB port of the recorder. Select "System Update", the firmware you want to install and confirm the entry.

The update process may take a few minutes.

Note: Please note that a new firmware fixes bugs, updates protocols and optimises/changes functions, e.g. to optimise computing performance or increase security. It is therefore strongly recommended to reset the system to factory settings after the update and to adjust it to the new firmware. > See *Update*

## 6.7 Main menu → Application → Backup

Open the menu item "Backup" in the main menu.

### Note

If you want to export a file directly to the PC, log in to the recorder via the web interface. To transfer a file to a USB stick, connect it to the recorder and operate the system with the mouse.

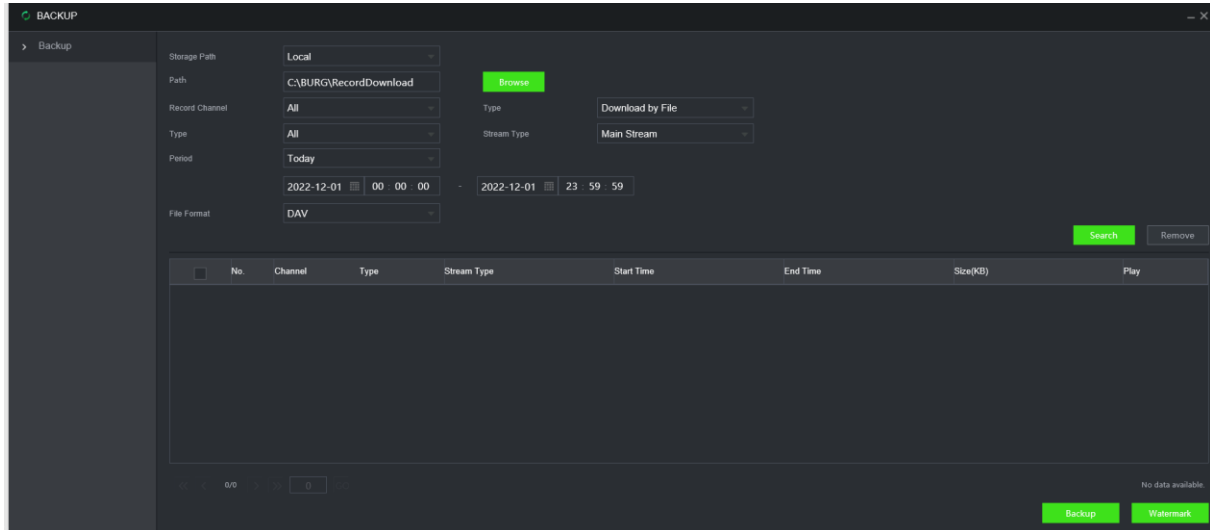

Here you can select the device for the backup, the start and end time of the recording, the camera channel and the file format. Click on "Add". A summary of the backup jobs you have just entered appears:

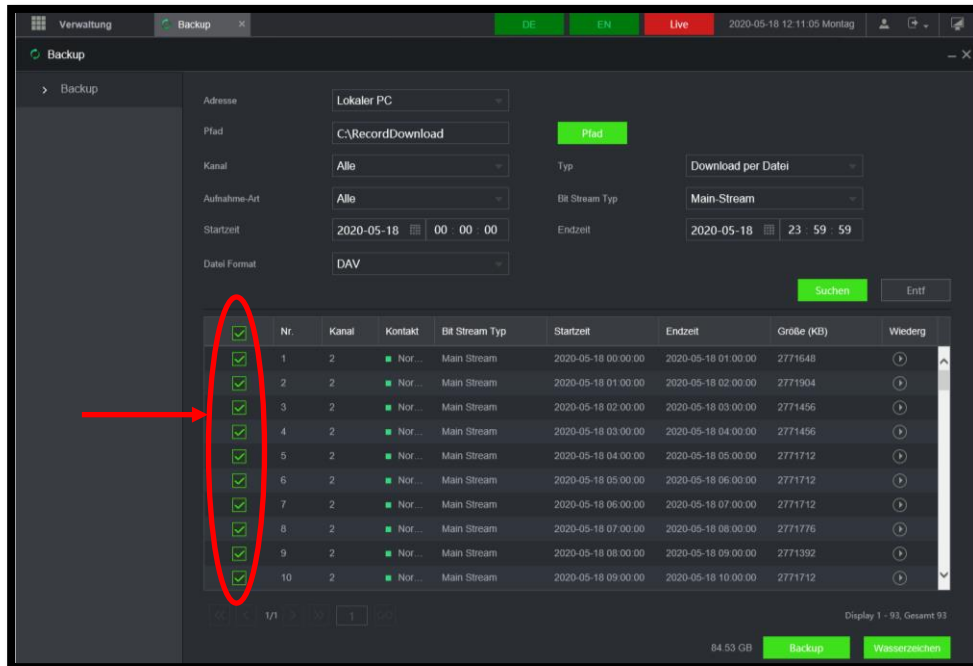



- The recorder automatically calculates the required storage capacity for this backup.
- Confirm that you want to save each recording as a backup by placing a tick in front of it.
- Click on "Start" to start the backup process.
- The remaining time needed for the backup is displayed.
- If the backup has been carried out successfully, a corresponding message appears.

Hint:

If you cancel the backup process before it is finished, only the files that have been backed up so far are saved. For example, if you have selected a total of 10 files for backup and cancel the process after 7 files, only these 7 files are saved as backup.

## 6.8 Main menu → Display

Manage the display settings, resolutions and screen display.

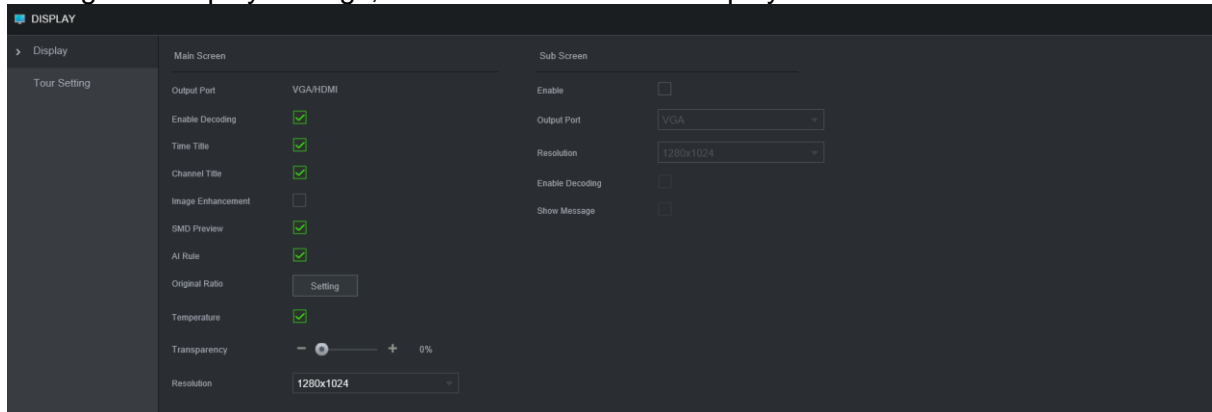

### 6.8.1 Main menu → Display → Display

Here you can make settings regarding overlays in the video image.

- Transparency  
Here you can set the transparency of the displayed menu above the live image. In this way, the live image can also be observed during menu navigation.
- Time display, channel display  
Set whether the time / channel name should be displayed in the picture
- Show mainstream  
Retrieve all streams as mainstream, irrespective of the maximum pixels that can be displayed in real terms.

Note: Depending on the connected devices and the type of display, this can lead to a load on the decoder.

- IVA Rule Overview  
Show/hide the rules and object information in the live image
- Original scale  
The image is not displayed full screen but in the set 16:9 (4:3) format. This is useful for production and testing facilities, for example.
- Main screen  
Set the monitor here that is to display the menu as the main screen.
- Enable screen  
Allows you to enable / disable screen outputs.
- Temperature fade in  
Displays additional information from hybrid / thermal imaging cameras
- Screen  
Configuration of screens and alarm channels

## 6.8.2 Main menu → Display → Tour

Create tour views with different screen divisions for optimal viewing.

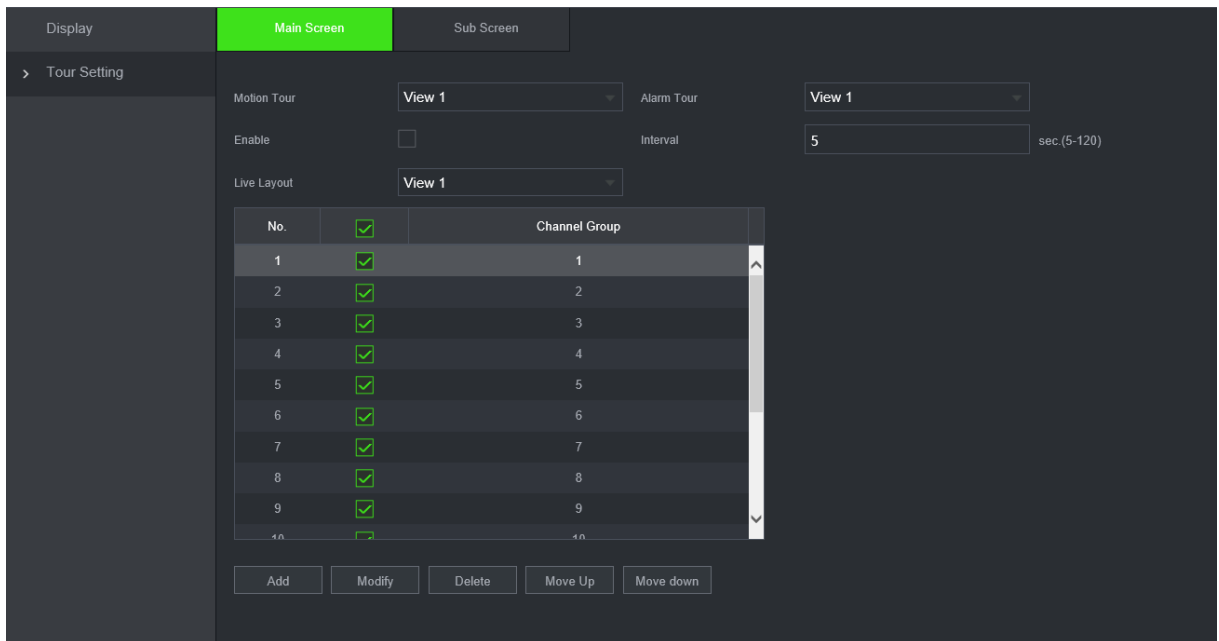

### Tour

- Activate tour: Activate tour function.
- Interval: Enter the tour interval (5-120 seconds).
- You can set the picture view (split).
- In the channel group list, you can edit the respective group by double-clicking on it.
- Use "Add" to add channel groups to the list.
- Use "Remove" to delete channel groups from the list.
- With "Up" or "Down" you can determine the order of the entries.

### 6.8.3 Main menu → Display → Customised display

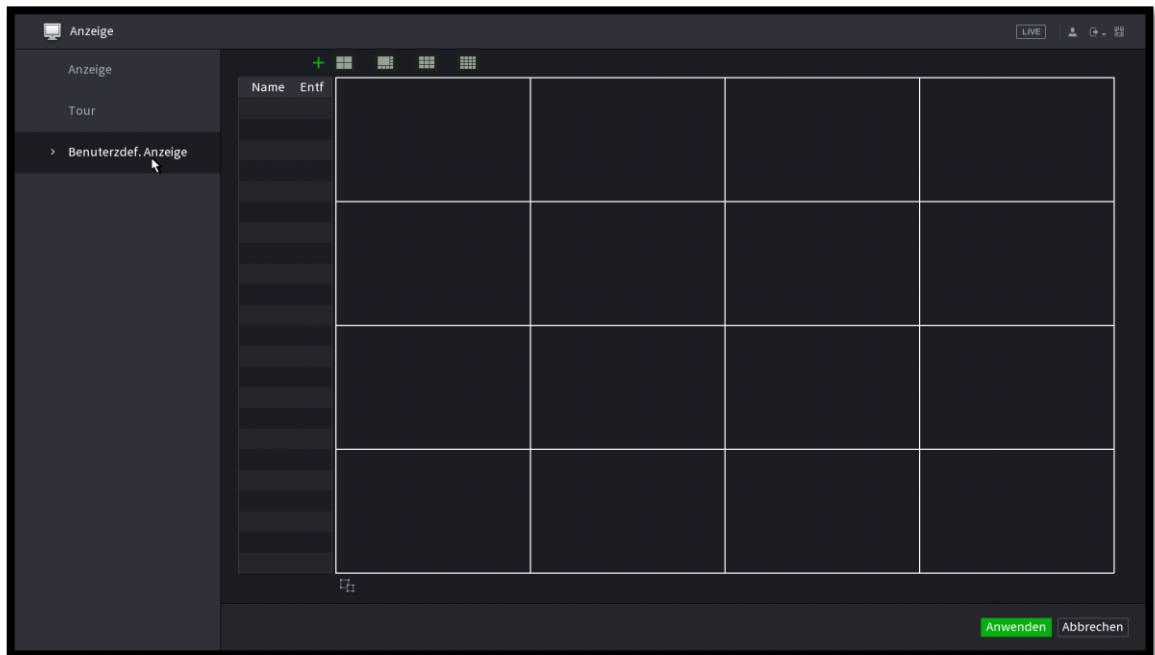

In this area you can create suitable advertisements for your application.

#### Creating a Custom Display

- Click on **+ to create** a new display (split)
- Select which basic grid your view should use (e.g. 4x4).
- To connect several boxes, hold down the left mouse button in a box and drag the mouse over the boxes to be connected.
- To uncheck contiguous boxes, click at the bottom left:  

- To save, click on "Apply".

#### Using a Custom Display

To use the view you have defined in the live image, open the quick menu in the live view, move the mouse to the "Ben. Display". Select your self-designed display here.

## 6.9 Main menu → Audio

Here you can make settings for an announcement.

### 6.9.1 Main menu → Audio → File manager

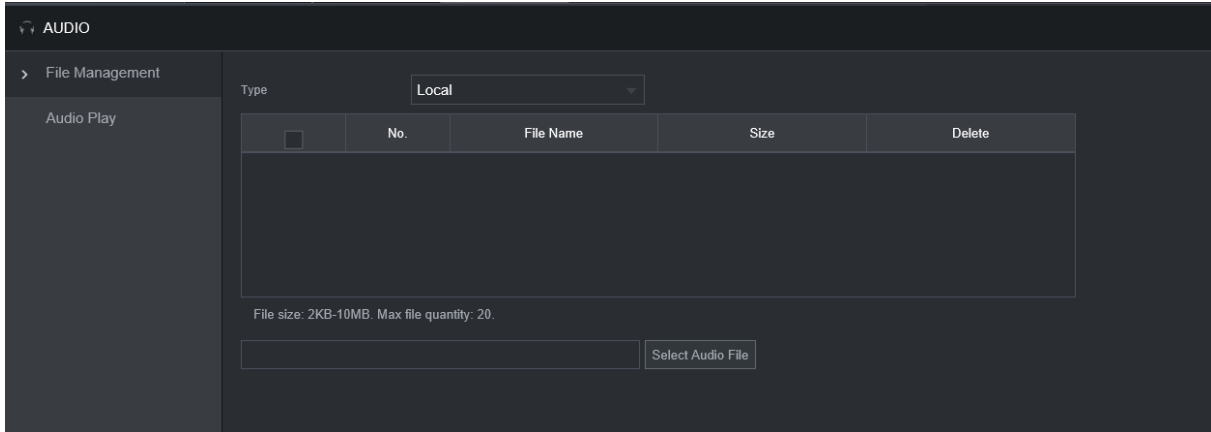

#### File management:

- Insert a USB stick into the recorder that contains an audio voice file or other audio file that you want to play in the event of an alarm.
- The audio voice file or the audio file may be max. 10MB in size.
- Click on "Add" and select the file from the stick.
- Up to 255 different files can be uploaded.
- The selected file(s) are listed in the overview list.
  
- To export an existing file, select it and click on "Add to Remote". The file will then be copied to the USB stick.

### 6.9.2 Main menu → Audio → Schedule

You can use the schedule to define if and when selected files are to be played at specific times and how often they are to be repeated.

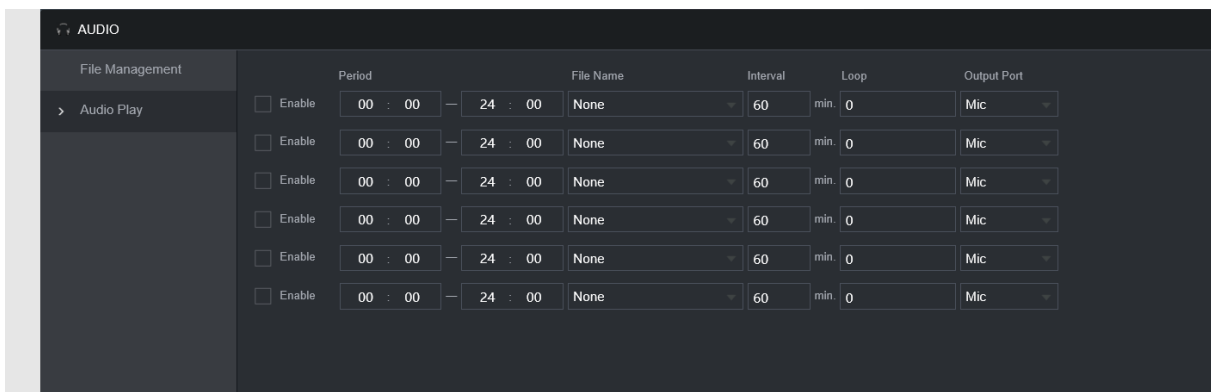

### 6.9.3 Main menu → Audio → Broadcast

You can address several channels simultaneously via broadcast groups.

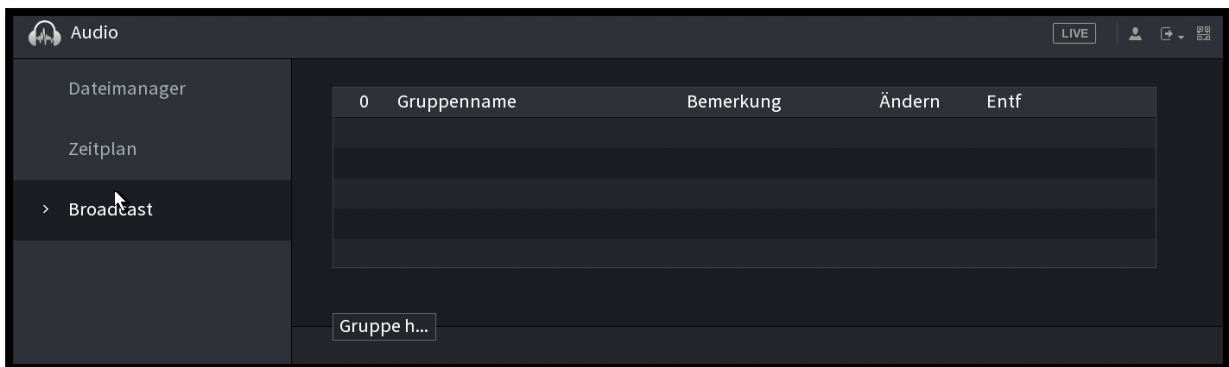

#### Add Broadcast Group

- Click on Add Group

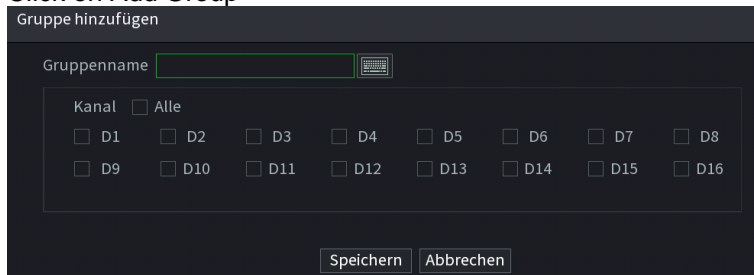

- Enter a group name
- Select the channels belonging to the group
- Click Save

#### Remove Broadcast Group

Click on the dustbin icon next to the entry to delete it.



## 6.10 Main menu → Log off / Shut down

Here you can choose between:

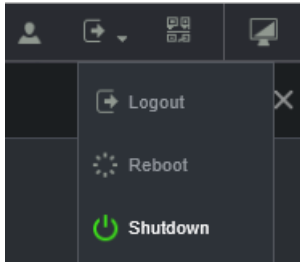

- Shutdown (switching off the recorder)
- Logout (e.g. to log out the user and log in with a new user).
- Manual restart of the recorder

**Note:** It is strongly recommended that you always shut down the recorder first. Only then should you switch it off using the on/off switch on the rear of the recorder.

## 6.11 Main menu → Administration → Camera

Here you can make camera settings

- Manage cameras
- Picture settings
- Image overlays
- Audio/Video
- Channel names
- Internal PoE switch management
- PTZ Setup

### 6.11.1 Main menu → Administration → Camera → Integrate devices

The screenshot shows the 'CAMERA' administration interface. The 'Camera List' section displays a table with the following data:

No.	Live	Status	IP Address	Port	Device Name	Manufacturer	Type	MAC Address
1	<input checked="" type="checkbox"/>	✓	192.168.178.42	37777	SNVR-31642e	BURG-WÄCHTER	SNVR-31642e	00:00:23:34:45:77

The 'Added Device' section displays a table with the following data:

Channel	Edit	Delete	Status	IP Address	Port	Device Name	Remote CH No.	Manufacturer	Camera Name	Webpage	Type
1			●	192.168.178.43	37777	BWNC-842D...	1	BURG-WÄC...	SNC		BWNC-842D...
2			●	192.168.178.44	37777	SWC-241RBL...	1	BURG-WÄC...	Visual		SWC-241RBL...
3			●	192.168.178.44	37777	SWC-241RBL...	2	BURG-WÄC...	Thermal		SWC-241RBL...

#### Device search

If you click on "Device search", all IP devices (IP cameras) that are connected to the recorder and are in the same network as the recorder are searched for and listed.

Place a tick next to the desired device and click on "Add" to add the device (camera). The image of this camera will then be visible in the live view.

In the list of "Added devices", all cameras are listed that are currently actively displayed on the recorder (live view). You can delete cameras via "Remove". Use the pencil icon to make or change settings for this camera.

To see where a camera that has not yet been integrated is looking, you can click on the preview button and display the live image.



**Example:**

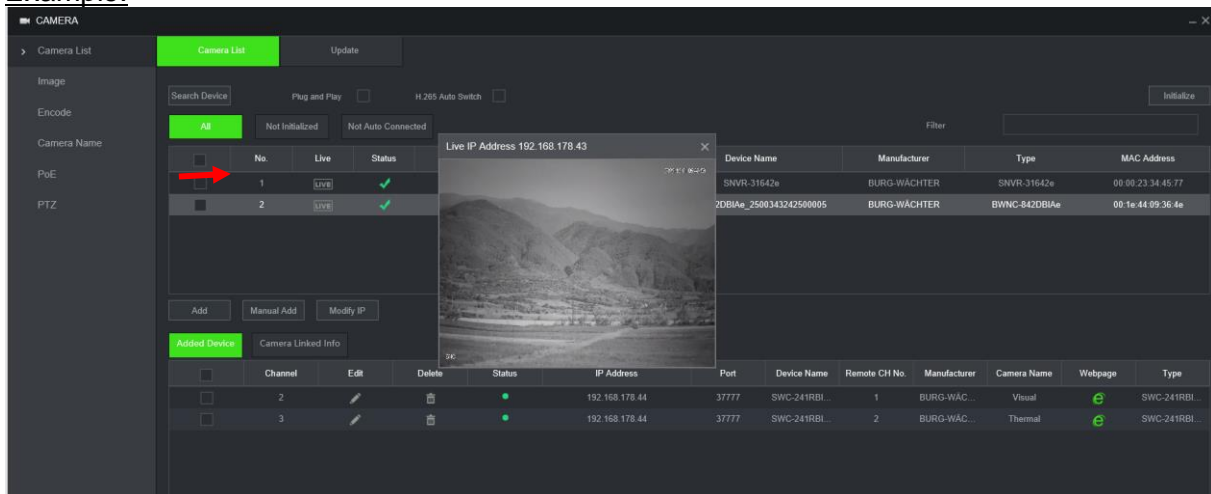

Via the web interface, you can also directly open the web page of a device if it is located in the same network segment and has been added to the NVR.

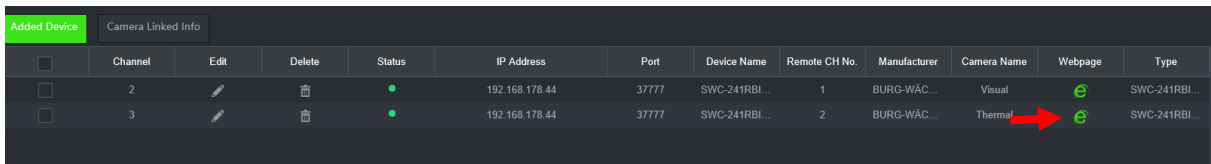

To change the IP of a device, click on: "Change IP" and assign a new device IP address in the network segment of the recorder.

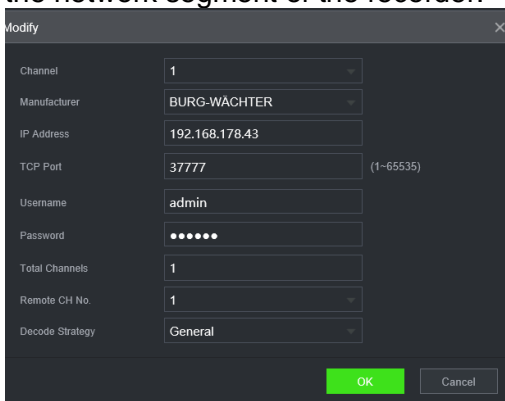

**Notes:**

- For "Added devices", the channel number and port number may be different as they are independent of each other.
- Only cameras that are connected to the main network connection of the recorder via a separate switch can be removed from the list of "Added devices". Cameras that are connected directly to the recorder cannot be removed/deleted as they are always automatically detected and re-added.
- Units that have not yet been initialised are set to factory defaults and must first be initialised with a password you specify before they can be used. Check the box "Not

initialised". to list only these units. Then select these units and click the "Initialise" button. Several units can be initialised at the same time.

### Device status:

Status of the individual cameras and their alarm status.

Kanal	Status	IP-Adresse	Bewegung	Videoverlust	Sabotage	Alarmein...	Kanalbez.	Fabrikat	Type
1	●	192.168.178.231	●	●	●	●	BWNC	BURG-WÄC...	BWNC-442DSIA
2	●	192.168.178.187	●	●	●	●	Visual	BURG-WÄC...	SWC-241RBIF
3	●	192.168.178.187	●	●	●	●	Thermal	BURG-WÄC...	SWC-241RBIF
4	●	192.168.178.164	●	●	●	●	SNC	BURG-WÄC...	BWNC-842DFIF
5	●	192.168.178.212	●	●	●	●	SNC	BURG-WÄC...	BWNC-842DDIAe
6	●	192.168.178.157	●	●	●	●	SNC	BURG-WÄC...	BWNC-842DDIAe

Green = connected/no alarm; Red = not connected/alarm.

### Firmware:

This lists which firmware version is installed on the individual cameras.

### Update:

Here you can install firmware updates on the cameras. In the local menu, connect a USB stick with the new camera firmware and follow the instructions in the menu.

Channel	Status	IP Address	System Version	Status	Port	Type	Manufacturer
1	●	192.168.178.43	2.800.00BW002.0.R.2021-11-02	Pending	37777	BWNC-842DBIAe	BURG-WÄCHTER
2	●	192.168.178.44	2.631.00BW000.0.R.2020-04-03	Pending	37777	SWC-241RBIF-T	BURG-WÄCHTER

## 6.11.2 Main menu → Administration → Camera → Picture settings

Picture settings to adjust to lighting conditions and personal feeling.

Note: You can also reach this page via the quick menu → Camera

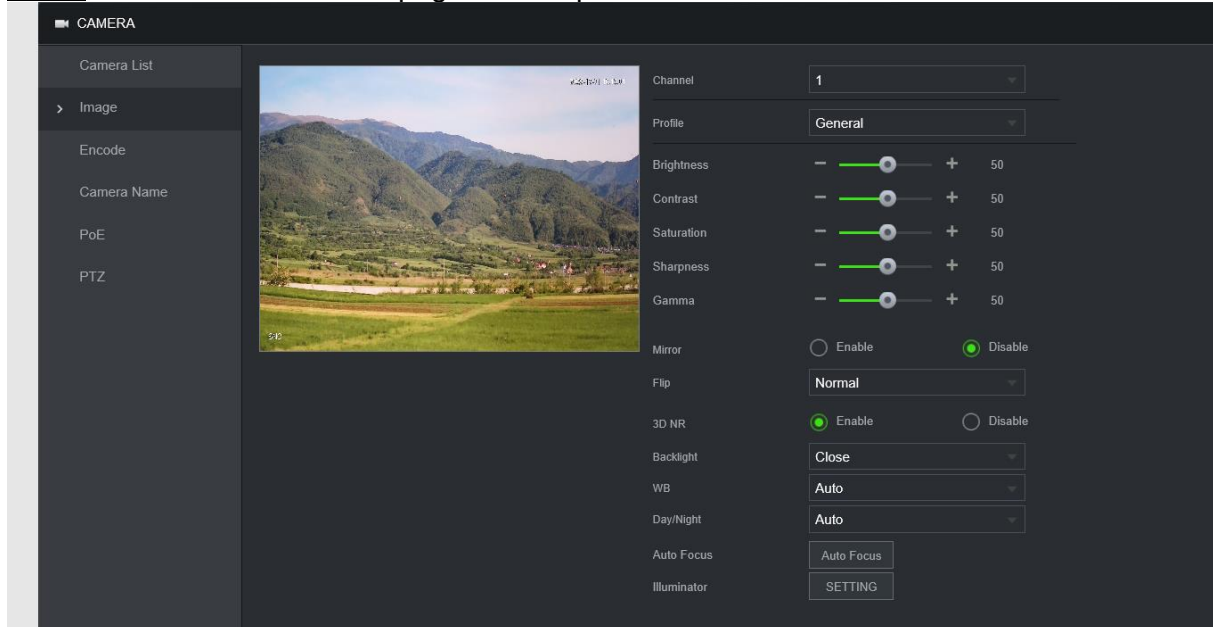

<b>Channel</b>	Select the channel for configuration here
<b>Profile</b>	Choose from a predefined or individual profile
<b>Brightness</b>	Image brightness
<b>Contrast</b>	Contrast of the image
<b>Saturation</b>	Colour saturation of the image (higher = more colourful)
<b>Sharpness</b>	Subsequent sharpening of the image
<b>Gamma</b>	Gamma adjustment to scene
<b>Rotation</b>	Image rotation in 90° steps (if supported by camera)
<b>BLC (Backlight) mode</b>	Backlight modes, depending on camera functions
<b>3DNR</b>	Noise reduction
<b>White balance</b>	Sets the type of white balance
<b>Day &amp; Night Mode</b>	Control of the camera's day/night mode

### 6.11.3 Main menu → Administration → Camera → Overlay Overlay

Insertion of time, channel name and user-defined text in the display.

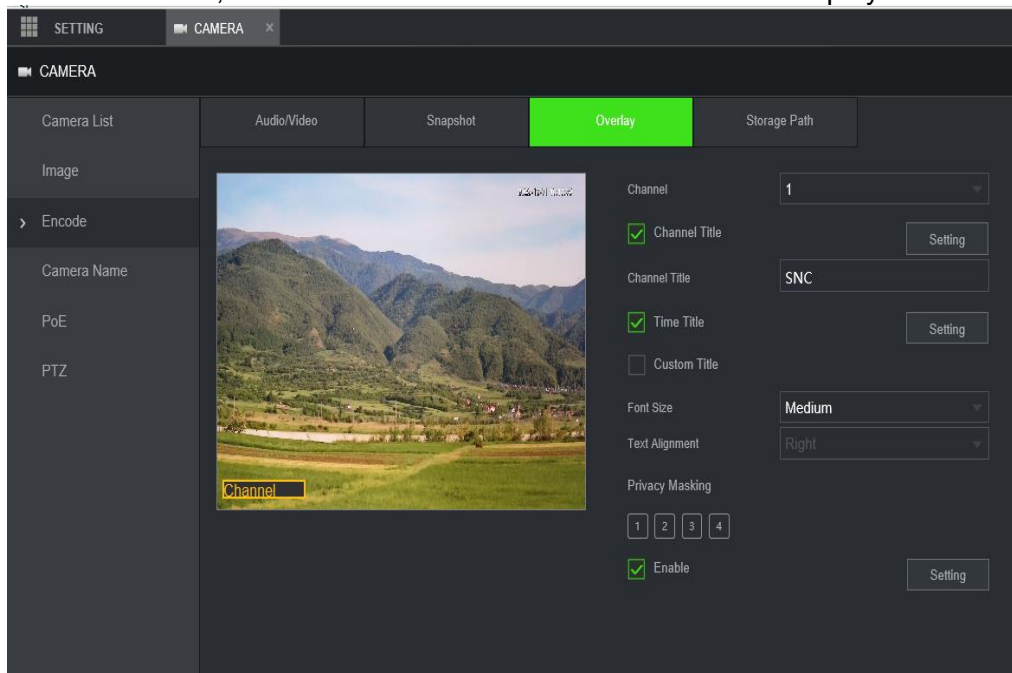

#### Fade in private masks

Fade private masks into the live view or into the recording.

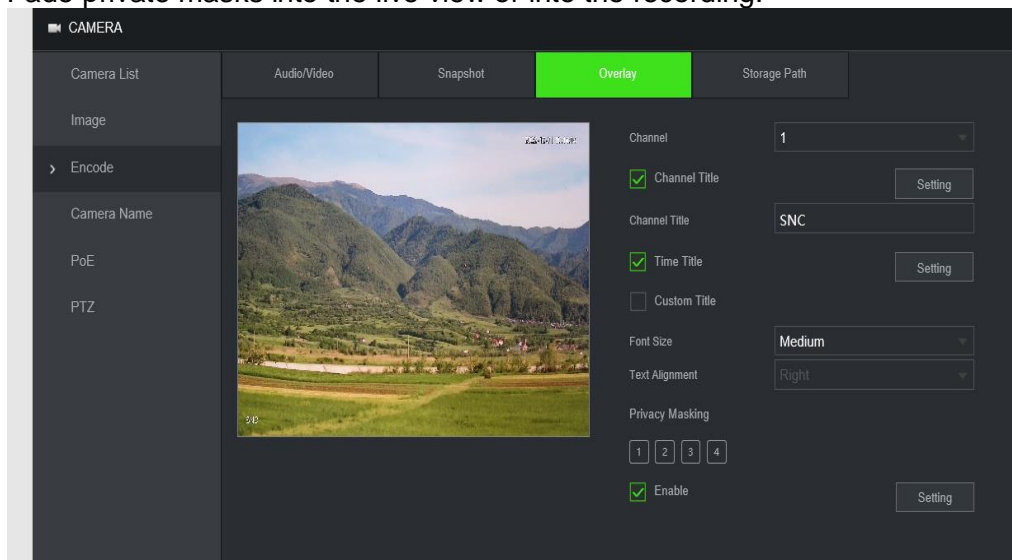

### 6.11.4 Main menu → Administration → Camera → Audio/video

Audio/video stream configuration for main/main stream and the sub/extra stream(s)

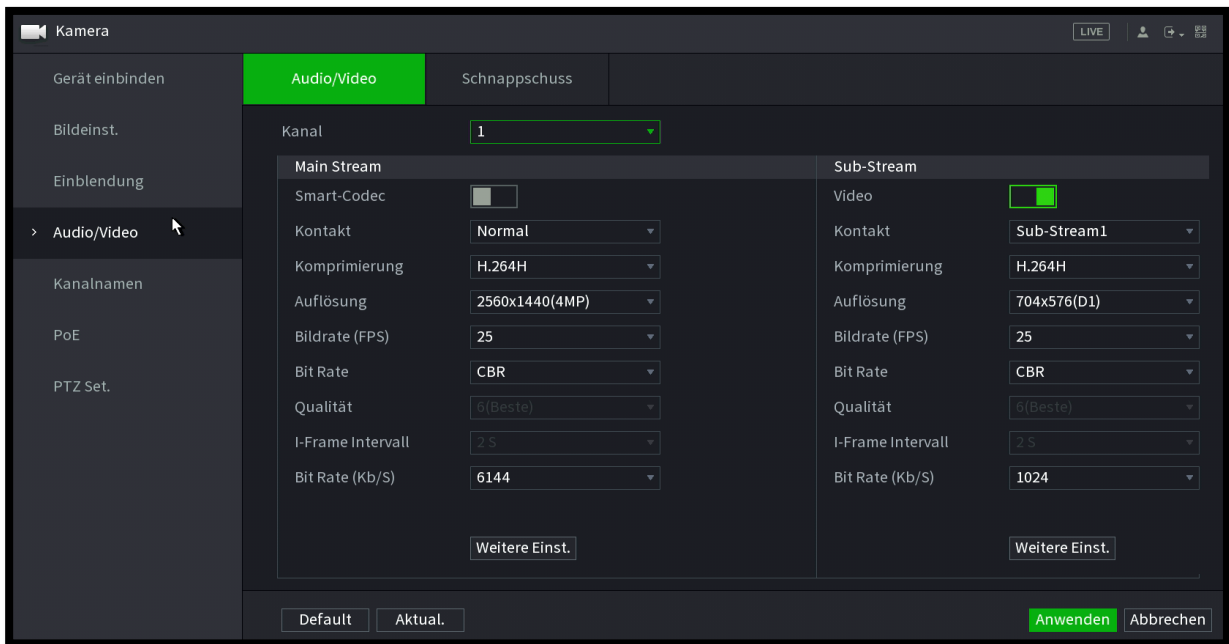

<b>Channel</b>	Select the channel for configuration here
<b>Smart Codec</b>	The extended standards H.264+ and H.265+ are referred to as Smart Codec. Depending on the settings, you can activate the + option on compatible devices and thus save bandwidth and storage space.
<b>Compression</b>	Select the codec with which the stream is to be retrieved from the camera. For newer devices, the powerful H.265(+) is recommended.
<b>Resolution</b>	Resolution of the camera stream. Among other things, the available frame rate depends on this.
<b>Frame rate</b>	Number of frames per second (BPS/FPS)
<b>Bit Rate Type</b>	Depending on the selected operating mode, the adjustable parameters change  CBR = Constant bit rate - usually for limited network capacity and constant recording time  VBR = Variable Bit Rate - usually for jumping data rates when storage space is limited and network capacity is sufficient.
<b>Quality</b>	Assumes VBR as the selected bitrate type
<b>I-Frame Interval</b>	Full screen repeat rate
<b>Bitrate (Kbps)</b>	Stream bit rate in Kbps. The higher the better the picture quality
<b>Further Einst.</b>	Switching the audio function of the stream on/off

### 6.11.5 Main menu → Administration → Camera → Camera name

Here you can assign or change the names for the individual cameras/channels by clicking in the name field using the virtual keyboard.

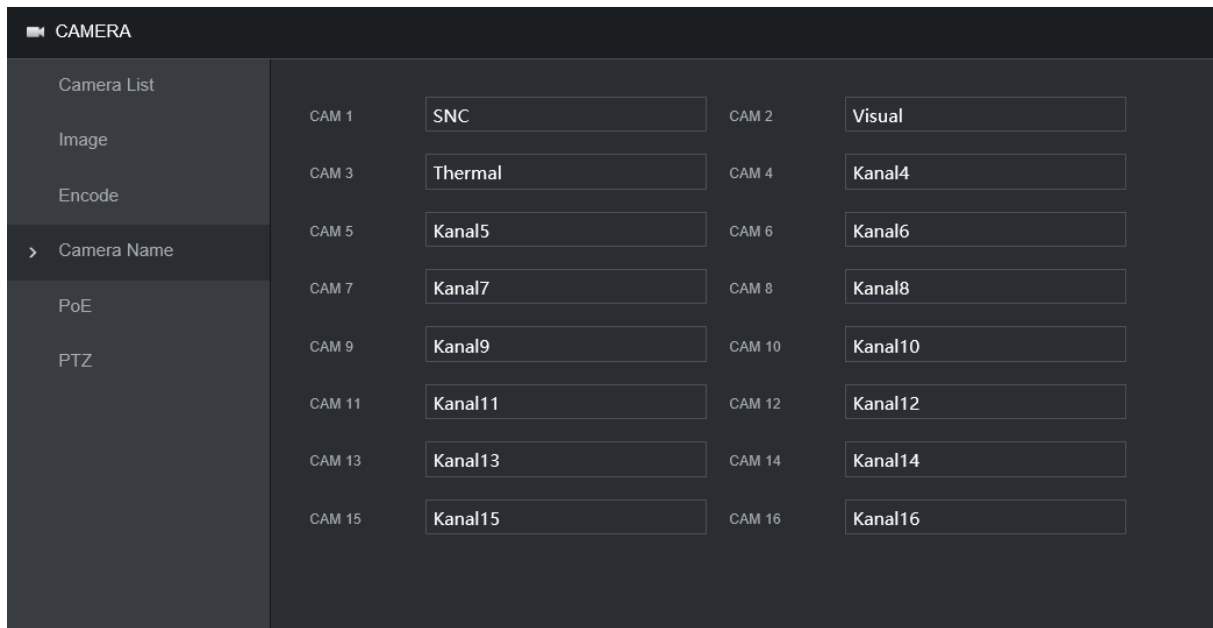

### 6.11.6 Main menu → Administration → Camera → PoE

Shows the list of occupied channels of the built-in (e)PoE switch with current information on the connection quality, max. data rate and power output in watts (W).

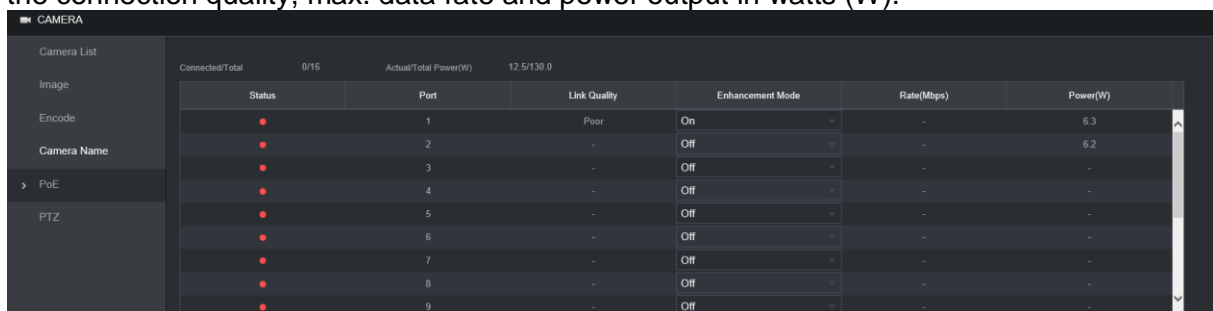

With ePoE switches, it is also possible to switch (manually) to extended mode in order to establish an even better connection quality. To do this, switch the mode to "On" in the "Improve" column.



### 6.11.7 Main menu → Management → Camera → PTZ Setup

Settings for PTZ control of a channel.

- Select the channel you want to configure.
- Set the PTZ control type to the desired format
  - Remote  
Network
  - Local  
RS485 Setup

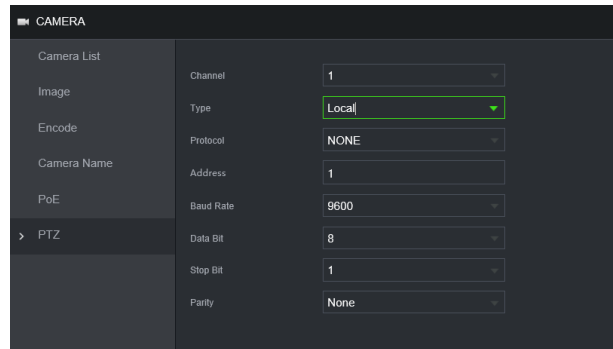

Camera List	Channel
Image	1
Encode	Type: Local
Camera Name	Protocol: NONE
PoE	Address: 1
> PTZ	Baud Rate: 9600
	Data Bit: 8
	Stop Bit: 1
	Parity: None

**Note:** If more power is required at the internal PoE switch than it can supply, the ports are switched off sequentially, from port 1 to port (8/16).

### 6.12 Main menu → Administration → Network

Here you can make settings for:

- TCP/IP
- Port Setup
- PPPoE
- DDNS
- UPnP
- IP filter
- E-mail
- FTP setting
- SNMP
- Multicast
- Alarm report
- Register
- Cluster IP
- Switch
- P2P Setting

## 6.12.1 Main menu → Administration → Network → TCP/IP

Here you can make the following settings:

- IP version: IPv4 or IPv6
- MAC address (no change possible)
- Mode: Static or DHCP
- IP address: Can only be assigned in static mode.
- Subnet Mask: Can only be assigned in static mode.
- Default Gateway: Can only be assigned in static mode.
- Preferred DNS: Enter IP address
- Alternative DNS: Enter IP address

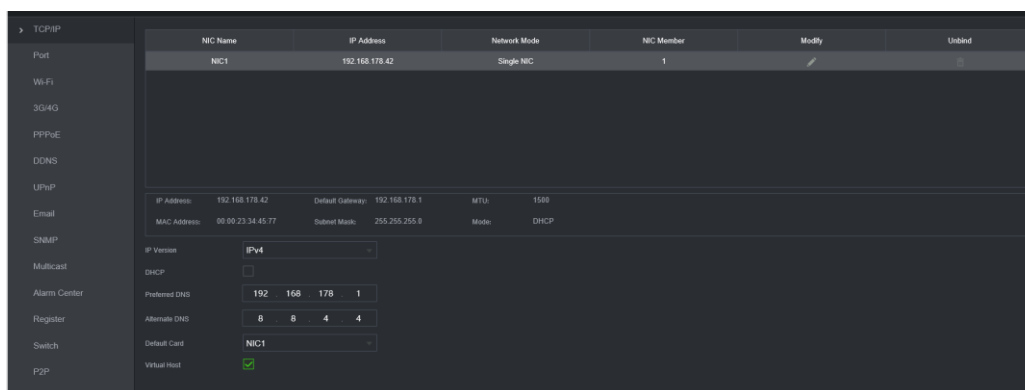

**Note:** DHCP is activated at the factory. If you want to use a fixed IP, please adjust the settings accordingly.

To edit the settings, click on the Edit icon  in the list of network adapters.

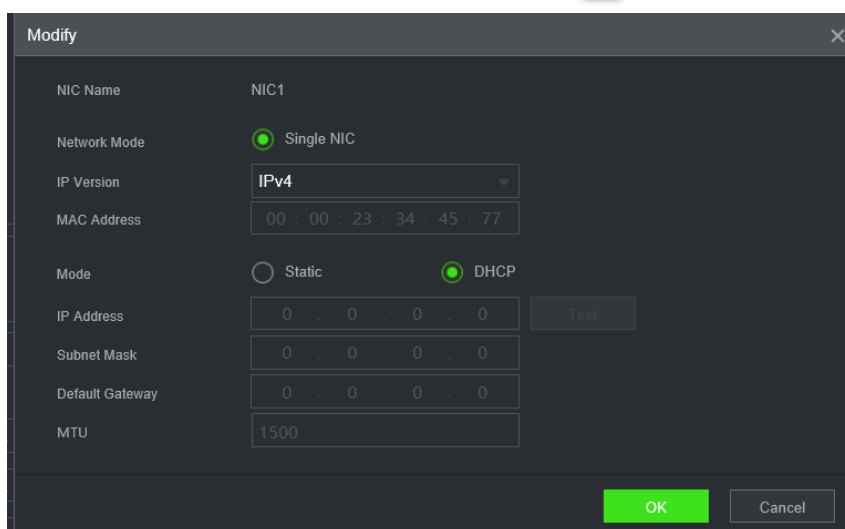

Deactivate DHCP to assign a fixed IP address.

**Note:** It is recommended not to change the MTU (Maximum Transmission Unit).

Click on Save to apply the settings. It may take a few seconds before the system can be reached at the address entered.



## 6.12.2 Main menu → Administration → Network → Port Setup

Here you can change the default ports for applications:

- Max. Number of connections, i.e. users (max. 128)
- TCP Port
- UDP Port
- HTTP Port
- HTTPS Port (Default: Off)
- RTSP Port
- NTP Server
- POS Port

Note: Changing the ports from the default is not recommended.

When changing the ports, please note that these must also be changed on the other side. Changing to a port already used by other applications / standards can lead to functional impairments.

Category	Parameter	Value	Range
TCP/IP	Max Connection	128	(0-128)
	TCP Port	3777	(1025-65535)
Port	UDP Port	3778	(1025-65535)
	HTTP Port	80	(1-65535)
Wi-Fi	HTTPS Port	443	(1-65535)
3G/4G	RTSP Port	554	(1-65535)
PPPoE	NTP Server Port	123	(1-65535)
DDNS	POS Port	38800	(1025-65535)
UPnP	RTSP Format	rtsp://<Username>:<Password>@<IP Address>:<Port>/cam/realmonitor?channel=1&subtype=0 channel: Channel, 1-16; subtype: Stream Type, Main Stream 0, Sub Stream 1.	
Email			
SNMP			
Multicast			
Alarm Center			
Register			
Switch			
P2P			

### 6.12.3 Main menu → Administration → Network → 3G/4G

Note: Only supported when retrofitting a corresponding 3G / 4G USB adapter.

NETWORK

TCP/IP

Port

Wi-Fi

> 3G/4G

PPPoE

DDNS

UPnP

Email

SNMP

Multicast

Alarm Center

Register

Switch

P2P

3G/4G

Mobile Settings

Network Type: No Service  Enable

APN:   Activate by Dial-up/SMS

Authentication Type: PAP

Dial-up No.:

Username:

Password:

Network Status

IP Address:

Wireless Signal:

If a corresponding adapter is used, you can activate the function and enter your access data.

**Note:** You may incur costs for the connection, note the selected settings (bandwidth, accessibility, access rights, etc.).

## 6.12.4 Main menu → Administration → Network → PPPoE

is the use of the network protocol Point-to-Point Protocol (PPP) over Ethernet (oE), i.e. via an Ethernet connection. PPPoE is mainly used today by providers for DSL and e.g. ADSL logins.

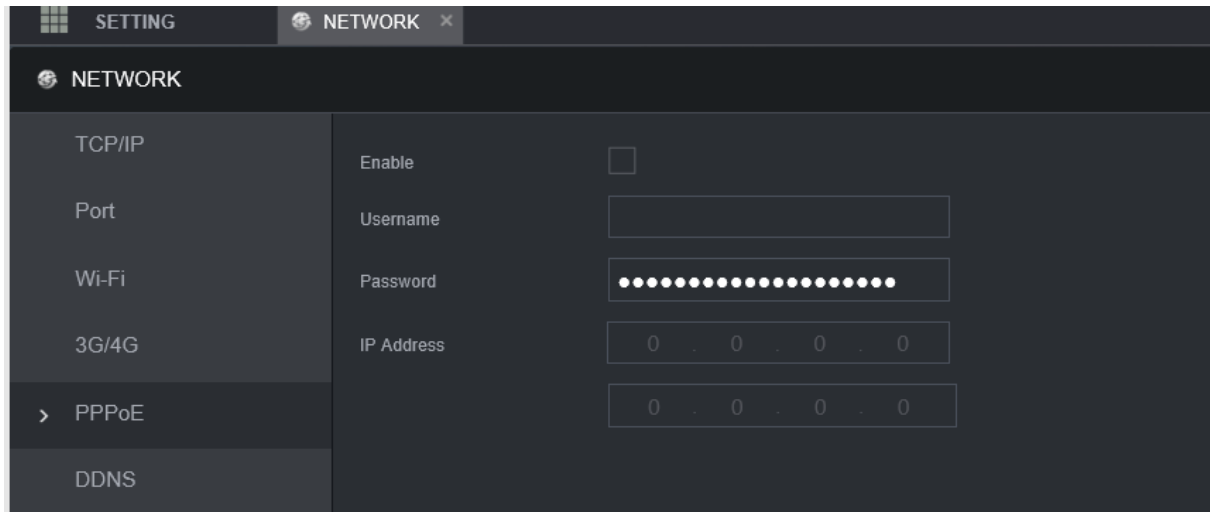

The screenshot shows a web-based configuration interface for a device. At the top, there are two tabs: 'SETTING' and 'NETWORK'. The 'NETWORK' tab is active. Below the tabs, the main heading is 'NETWORK'. On the left side, there is a vertical menu with options: 'TCP/IP', 'Port', 'Wi-Fi', '3G/4G', '> PPPoE', and 'DDNS'. The 'PPPoE' option is selected and highlighted. The main content area on the right contains the following fields:

- 'Enable': A checkbox that is currently unchecked.
- 'Username': A text input field.
- 'Password': A password input field with 16 dots.
- 'IP Address': Two rows of IP address input fields, each containing '0 . 0 . 0 . 0'.

Activate the PPPoE function and enter your user name and password (provided by your Internet Service Provider after signing the contract).

- Click on "Apply" and "OK".
- Restart the recorder.
- After restarting, the recorder automatically connects to the Internet.

Note: The system is directly connected to the Internet. To maximise security against possible attacks, please use HTTPS only and disable any functions that are not required. Keep the firmware of the 3G/4G dongel and the recorder permanently up to date.

## 6.12.5 Main menu → Administration → Network → DDNS

To set up the DDNS, you need a PC with DDNS software installed or a fixed IP address on the Internet. The PC thus serves as a DNS (Domain Name Server).

The screenshot shows the DDNS configuration interface. On the left is a sidebar menu with options: TCP/IP, Port, Wi-Fi, 3G/4G, PPPoE, > DDNS (selected), UPnP, Email, and SNMP. The main area contains the following fields:

- Enable:** A checkbox that is currently unchecked.
- Port:** A text field with the note: "After enabling DDNS function, third-party server may collect your device info."
- Type:** A dropdown menu set to "NO-IP DDNS".
- Server Address:** A text field containing "dynupdate.no-ip.com".
- Domain Name:** An empty text field with a green "Test" button to its right.
- Username:** An empty text field.
- Password:** A password field with 14 dots.
- Interval:** A text field containing "1440" with a note "min. (1440~2880)".

- Click on "Activate".
- Select the DDNS type. The server IP will then be set automatically.
- Enter the domain name you received from your Internet Service Provider.
- Click on "Apply" and "OK".
- Restart the recorder.
- After restarting, open your Internet Explorer and do the following Inputs:
  - [http://\(DDNS server IP\)/\(virtual directory name\)/webtest.htm](http://(DDNS server IP)/(virtual directory name)/webtest.htm)
  - [Ex: http://10.6.2.85/DVR\\_DDNS/webtest.htm](http://10.6.2.85/DVR_DDNS/webtest.htm).
- On the recorder, open the Network menu page again → DDNS

### Quick DDNS:

You can access the recorder via the DDNS using a registered domain name.

In principle, the Quick DDNS has the same function as other DDNS clients. The Quick DDNS connects the domain name with the IP address. The DDNS server is intended only for your device. You must update the connection of domain name and IP address at regular intervals. There is no user name, password or ID registration on the server.

Each unit has a default domain name that is generated via the MAC address. You can also use custom domain names.

Before using Quick DDNS, you must activate this service and set it up as follows:

- Server address: [www.quickddns.com](http://www.quickddns.com)



- Port number: 80
- Domain names: Either the default domain name or the custom domain name.
- Username: Is optional. You can enter your e-mail address here, for example.

Hint:

Domain names that have not been used for more than one year will be deleted from the system. Before this happens, however, you will receive an e-mail for information.

Note on Quick DDNS:

The Quick DDNS function depends on your network and may be blocked depending on your security settings.

## 6.12.6 Main menu → Administration → Network → UPnP

The UPnP protocol creates a connection between LAN and WAN. Please enter the router LAN and WAN address.

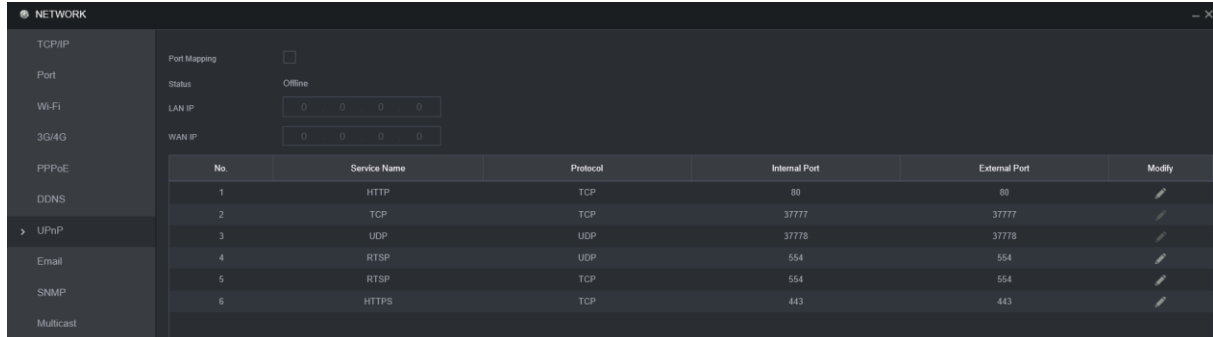

By clicking on the Edit button (pencil symbol) next to the respective service name in the list, you can define the internal and external ports.

Note: UPnP must be activated in the settings of your router for the function to work correctly.

### External port:

Please enter only ports > 49.152 to < 65535 to avoid port conflicts with standard applications.

You can find a list of standard ports, among others:

[https://de.wikipedia.org/wiki/Liste\\_der\\_standardisierten\\_Ports](https://de.wikipedia.org/wiki/Liste_der_standardisierten_Ports)



## 6.12.7 Main menu → Administration → Network → E-mail

Here you can store your e-mail information via which, in the event of an event, a notification is to be sent by e-mail, if necessary with a snapshot as an attachment.

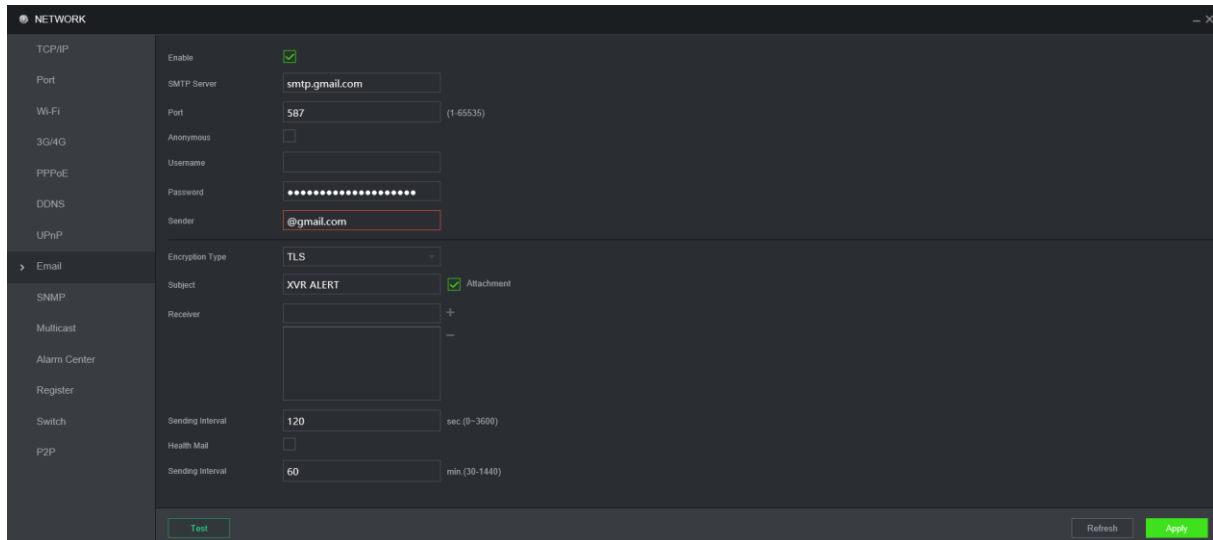

### Institution

- Activate the function by setting the button to On.
- SMTP Server, Port: Please enter the IP/domain of your e-mail SMTP server and its port. This information is provided by your e-mail service provider (GMX, WEB, GMail,...).
- User name, password: Please enter your login data here to retrieve your e-mail box.
- Recipient: Recipient's e-mail address (max. 3 e-mail addresses)
- Sender: e-mail address of the sender
- Subject: Here you can enter a subject line for the e-mail notification (max. 32 characters).
- Via "Attachment" you can define whether a snapshot is to be sent with an alarm.
- Encryption: Please select the appropriate encryption method of your provider. Please note that the port settings also depend on this.
- Interval: Enter the interval in minutes at which you want to receive a health notification.

Activate Health: Activate the function if you want to receive periodic messages about the availability of the system.

- Test: Click on the Test button if you want to send a test e-mail to check the settings.

**Note:** Recorders with firmware 4.0.20 use TLS version 1.3. Please check which version your mail provider supports.

## 6.12.8 Main menu → Administration → Network → FTP setting

To use the FTP server function, you must have one. If you do not have an FTP server, you must install one, e.g. Serv-U FTP Server.

Procedure:

- Acquire the Serv-U FTP Server by purchasing or downloading it.
- Install the Serv-U FTP server on your computer.
- Start it via: Start → Program → Serv-U FTP Server → Serv-U Administrator
- Enter the user password and FTP directory.
- Activate the write function.

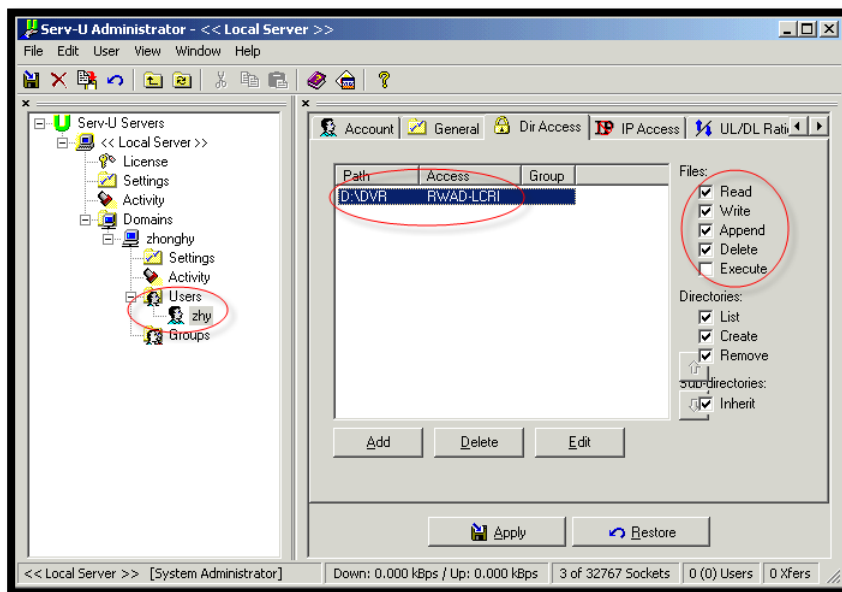

- Multiple recorders can be uploaded to an FTP server and multiple directories can be created.
- On the recorder, open the Network page → FTP Setting
- Place a tick next to "Activate".
- You can then enter the server information here. Please enter the login data for the FTP server as user name and password.
- You can check your entries via "Test".



## 6.12.9 Main menu → Administration → Network → SNMP

SNMP stands for Simple Network Management Protocol. The protocol can be used to check the availability of the systems with monitoring programmes.

Check "On" and fill in the specified fields according to your SNMP programme settings.

Parameter	Value
Enable	<input type="checkbox"/>
Version	<input type="checkbox"/> V1 <input type="checkbox"/> V2 <input checked="" type="checkbox"/> V3 (Recommended)
SNMP Port	161 (1-65535)
Read Community	
Write Community	
Trap Address	
Trap Port	162 (1-65535)
Read-Only Username	Public
Read/Write Username	Private
Authentication Type	MD5
Authentication Password	.....
Encryption Type	CBC-DES
Encryption Password	.....

Note: The SNMP port and trap port must not be identical.

### 6.12.10 Main menu → Administration → Network → Multicast

Multicast refers to the transmission of information from one point to a group (multipoint connection). Here, information is transmitted simultaneously to several participants or a group without the data transmission rate used for this being multiplied by the number of recipients at the sender. Thus, data packets can be sent efficiently to many recipients at the same time. This is done via special multicast IP addresses.

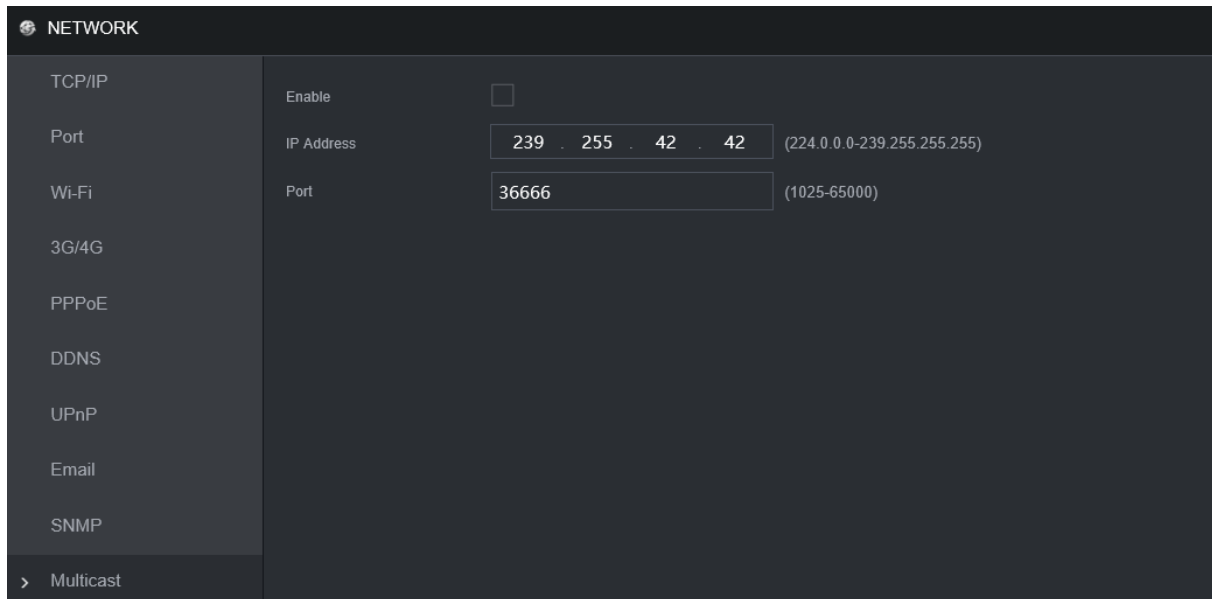

The screenshot shows the NETWORK configuration page with a sidebar on the left containing options: TCP/IP, Port, Wi-Fi, 3G/4G, PPPoE, DDNS, UPnP, Email, SNMP, and Multicast. The Multicast option is selected and expanded to show the following settings:

Enable	<input type="checkbox"/>
IP Address	<input type="text" value="239 . 255 . 42 . 42"/> (224.0.0.0-239.255.255.255)
Port	<input type="text" value="36666"/> (1025-65000)

#### IP address:

- Valid range for multicast group: 224.0.0.0 to 239.255.255.255 (for IPv4), i.e. you can use for multicast e.g. this IP: 235.8.8.36
- Reserved area: 224.0.0.0 to 224.0.0.225, e.g.:
  - 224.0.0.1: All systems in the Sub-Net
  - 224.0.0.2: All routers in the subnet
  - 224.0.0.4: DVMRP Router
  - 224.0.0.5: OSPF Router
  - 224.0.0.13: PIMv2 Router
- Administrative addresses: 239.0.0.0 to 239.255.255.255: Cannot be used for Internet transmissions.



### 6.12.11 Main menu → Administration → Network → Alarm report

Here you can set whether and when an alarm report is to be created and on which server it is to be stored.

The screenshot shows the NETWORK configuration page with the Alarm Center option selected. The left sidebar lists various network protocols: TCP/IP, Port, Wi-Fi, 3G/4G, PPPoE, DDNS, UPnP, Email, SNMP, Multicast, Alarm Center (selected), and Register. The main area displays the following settings for the Alarm Center:

- Enable:
- Protocol Type: HTTP (dropdown)
- Server Address: [text input] Test
- Port: 1 (1-65535)
- Image Upload Path: [text input] Example: /example/
- Server Address: [text input] Test
- Port: 1 (1-65535)
- Image Upload Path: [text input] Example: /example/

### 6.12.12 Main menu → Administration → Network → Register

Using this function, the recorder can automatically log on to a proxy. The proxy acts like a switch here.

Enter the IP, port and IP of the proxy and tick "Activate".

The screenshot shows the NETWORK configuration page with the Register option selected. The left sidebar lists various network protocols: TCP/IP, Port, Wi-Fi, 3G/4G, PPPoE, DDNS, UPnP, Email, SNMP, Multicast, Alarm Center, and Register (selected). The main area displays the following settings for the Register function:

- Enable:
- No.: 1 (dropdown)
- Server Address: 0.0.0.0
- Port: 7000 (1-65535)
- Sub-Device ID: 0

### 6.12.13 Main menu → Administration → Network → Switch

Here you can set the IP address, subnet mask and gateway for the switch.

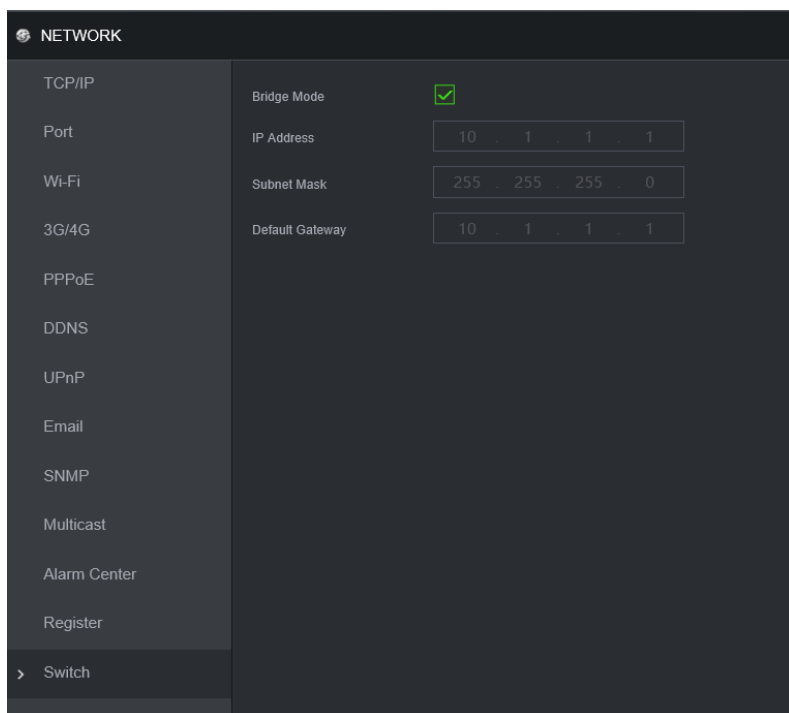

### 6.12.14 Main menu → Administration → Network → WLAN

With a corresponding dongle, you can establish the WLAN connection to a network in this menu.

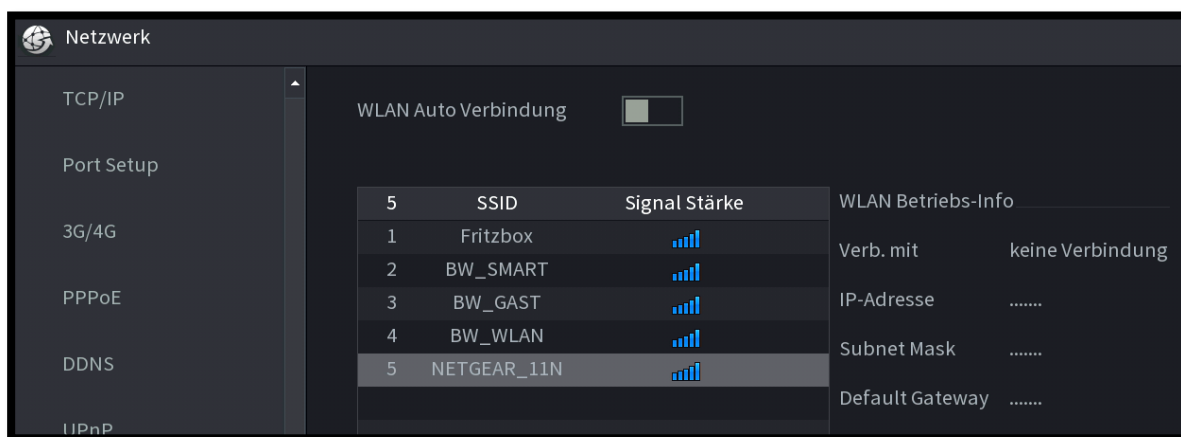



- Select the desired network from the list of available networks.
- Enter your connection data and click on "Connect".
- If "WLAN Auto Connection" is deactivated, the connection is only established once. Activate the function to re-establish an automatic connection after termination.

WLAN-Verbindung	
SSID	Fritzbox
Status	keine Verbindung
Verifikationstyp	WPA2-PSK
Verschlüsselungstyp	AES
Verbindungs Pass...	
DHCP	<input checked="" type="checkbox"/>
IP-Adresse	0 . 0 . 0 . 0
Subnet Mask	0 . 0 . 0 . 0
Default Gateway	0 . 0 . 0 . 0

Verbinden    Speichern    Zurück

### 6.12.15 Main menu→ Administration→ Network→ P2P Setting

Here you can scan a QR code for the P2P app or activate/deactivate the P2P function.

The connection status (online/offline) is displayed. The status is updated within one minute after the function has been activated.

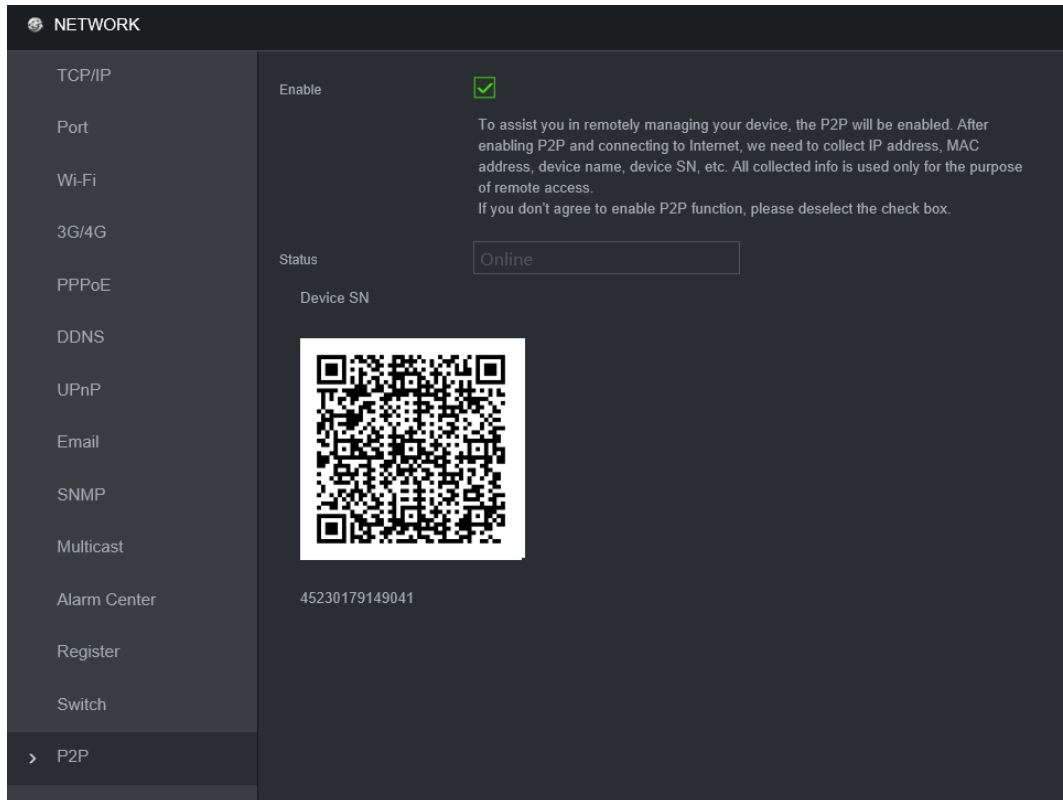

Note: If a P2P connection cannot be established:

- Check the network connection to the router
- Check if the router is connected to the internet
- Make sure that the gateway and IP filter are set correctly.
- Check your firewall / router security settings





### 6.12.16 Main menu → Administration → Network → 802.1x

802.1x is a port-based network protocol and supports manual selection of the authentication method used to verify that the device connected to the LAN is allowed access to the LAN. It supports the authentication, computation, security and management requirements of the networks.

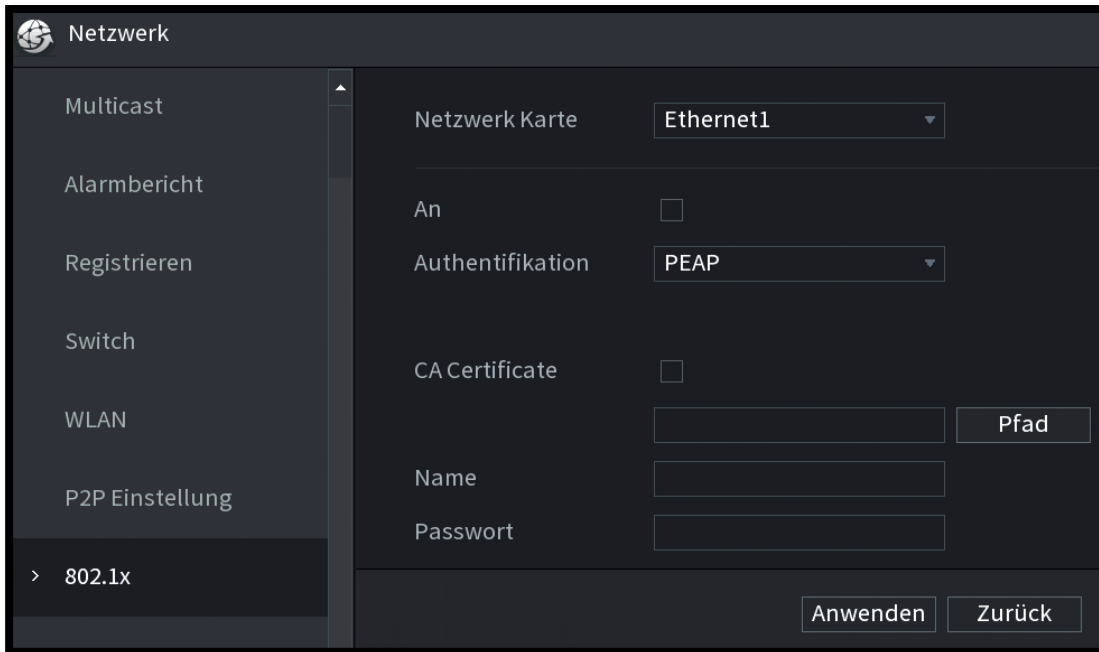

<b>Function</b>	<b>Description</b>
<i>Authentication</i>	EAP (Protected EAP Protocol)
<i>Username</i>	It needs the user name for the login. It is then authenticated by the server.
<i>Password</i>	Enter the password here.

## 6.12.17 Main menu → Administration → Network → IP Filter

You can store a maximum of 64 IP addresses (IPv4 or IPv6) here as "trusted" or "blocked". The recorder can only be accessed via the "trusted" IP addresses stored here. The "blocked" IP addresses stored here cannot access the recorder.

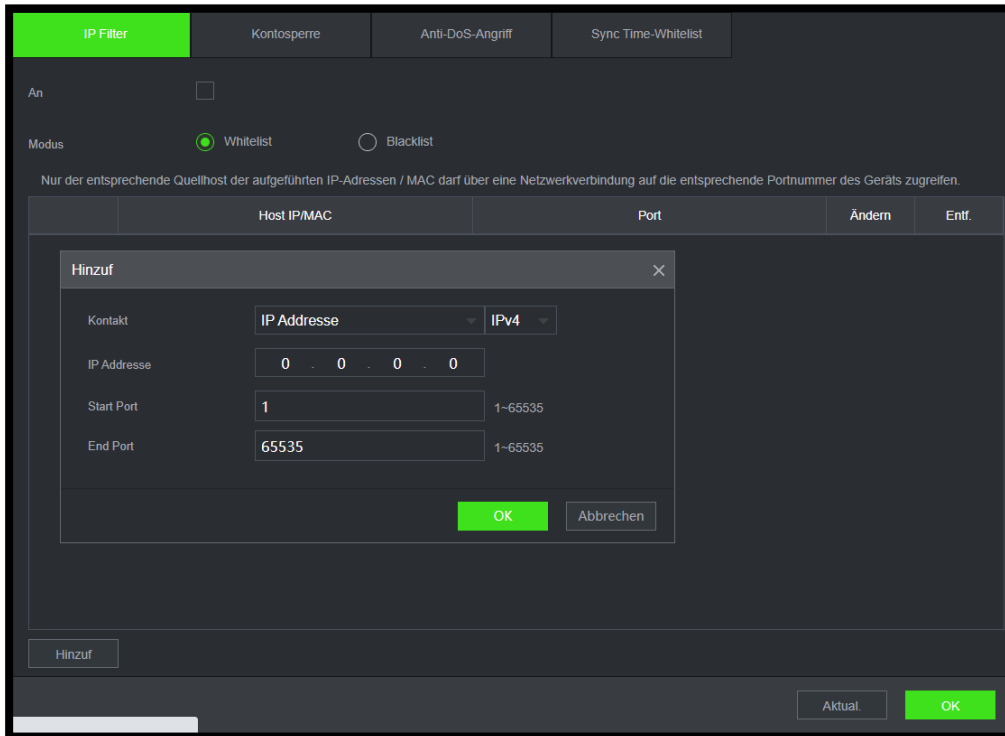

- Click the "To" box.
- Select "trusted" or "blocked" sites.
- Click on "Add".
- Use the virtual keyboard to enter the IP address or an IP address range, i.e. the beginning and end of the IP series, and click "OK".
- Click on "Apply" and "OK".
- If you click on "Default", all "trusted" and all "blocked" IP addresses are deleted and the list is empty.



### 6.13 Main menu → Administration → Memory

Make the memory settings here.

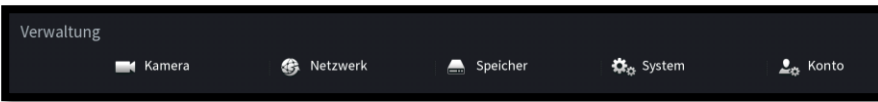
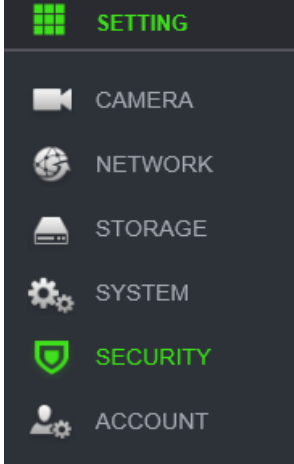
<p>Local monitor access</p>  <p>(below)</p>	<p>Network access</p>  <p>(top right)</p>
---	--

#### 6.13.1 Main menu → Administration → Memory → Memory General

Make the general memory settings here.

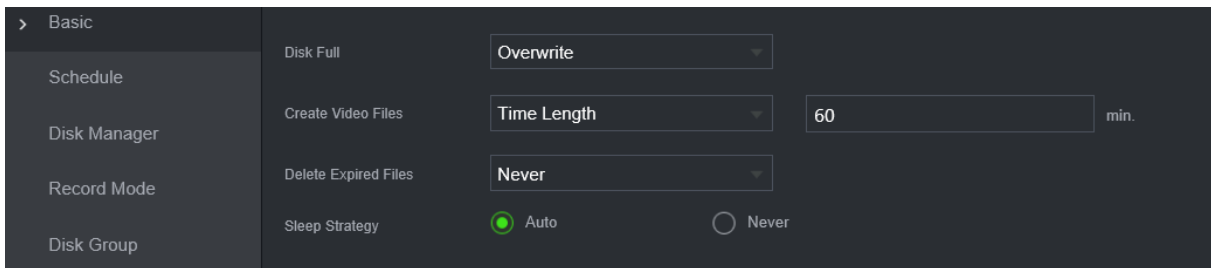

FUNCTION	SELECTION	DESCRIPTION
<b>HDD FULL</b>	Overwrite	Overwrites the oldest recorded data
	Stop recording	Recording stops when the memory is full
<b>PACK MODE</b>	Timetable	Data is stored in 60 minute packets
	File size	Data is stored in a max. file size
<b>AUTO. DELETE OLD FILES</b>	Never	Old data is retained for the maximum time, depending on the settings selected above.
	Custom Overwrite	Data is overwritten after a certain number of days

### 6.13.2 Main menu → Administration → Memory → Schedule

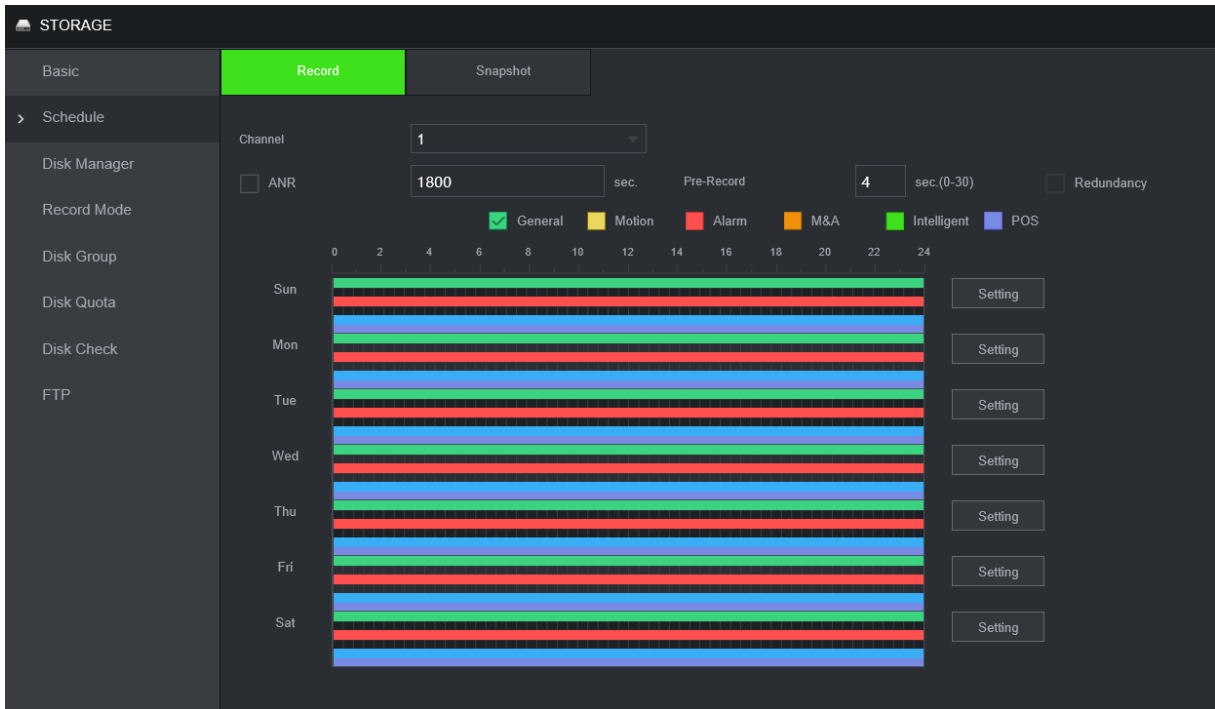

Here you can make settings for:

#### Recording:

- Select the desired channel and set the pre-recording duration (1-30 seconds).
- Redundancy: To be able to use this function, at least one hard disk must be marked as redundant. If there is only one hard disk in total, this function is not available.
- ANR: Automatic Network Reproduction technology:  
 If the network fails and the camera has an SD card, the missing recordings are downloaded from the camera's SD card so that you have all the data on the recorder.
- Set the type of event by ticking the corresponding box:

Colour	Meaning
Green	Permanent recording
Yellow	Standard motion detection
Red	Alarm contact
Orange	Alarm contact + motion detection
Blue	IVA
Purple	POS

Activate a desired day of the week or all days.



- To set the schedule per day and per hour for each event type, you have 2 options:
  - Activate the desired alarm type and click on the time or time period on the time bar of the corresponding day.
  - Click on the wheel symbol and manually enter the time or time period with the associated recording event.

The screenshot shows a 'Setting' dialog box with a close button (X) in the top right corner. At the top, there are checkboxes for days of the week: All, Sun (checked), Mon, Tue, Wed, Thu, Fri, and Sat. Below this, there are six rows labeled 'Period 1' through 'Period 6'. Each row contains two time input fields (HH : MM) separated by a hyphen, followed by a green checkmark in a box. To the right of each row are checkboxes for alarm types: General, Motion, Alarm, M&A, Intelligent, and POS. In the first row, 'Alarm' and 'Intelligent' are checked. At the bottom right of the dialog are 'OK' and 'Cancel' buttons.

- With the eraser, you delete all selected alarm types for the day in the timeline view.
- A maximum of 6 times/periods per day can be set across all event types.
- You can use the copy function to transfer the settings to other channels.

## Snapshot

To set up a schedule for creating a snapshot, please proceed in the same way as described above for recording.

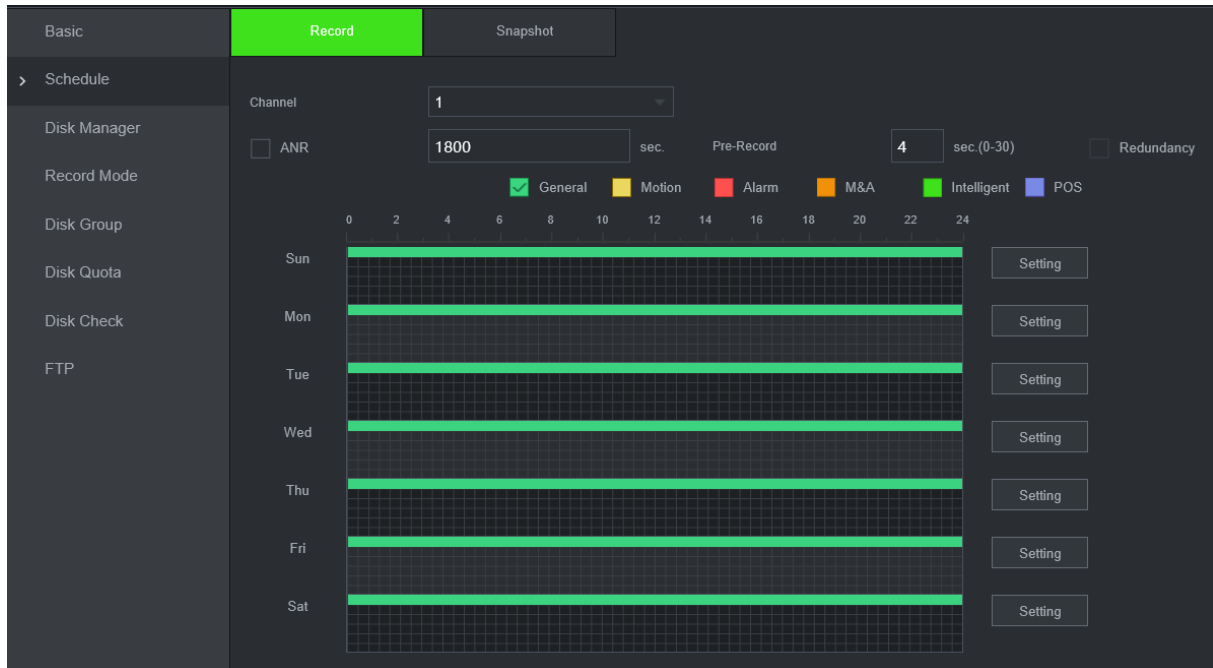

### 6.13.3 Main menu → Management → Storage → HDD Manager

In the hard disk management, define the mode in which the HDD is to be operated. You can choose between write/read, read, write.

You can format hard disks via the "Format" button. Please note that all recordings and information will be deleted.

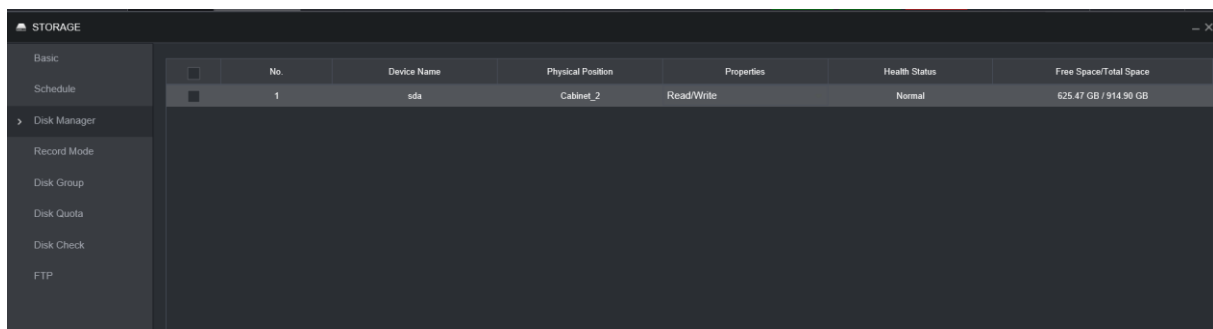

**Note:** Formatting of the hard disks should be carried out after installation, at the beginning of commissioning.



### 6.13.4 Main menu → Administration → Memory → HDD (hard disk)

Here you get an overview of the hard disk drive (HDD) or the hard disk drive groups and their respective assignment to the main stream, sub stream or snapshot.

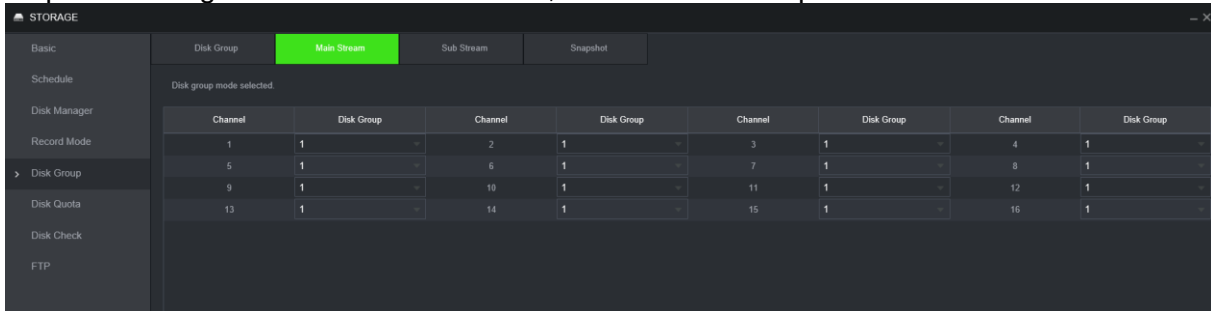

Select which channel is to be assigned to which HDD from the drop-down list.

### 6.13.5 Main menu → Administration → Memory → Recording

For manual recording, the functions "Schedule", "Manual" and "Off" are available per channel.

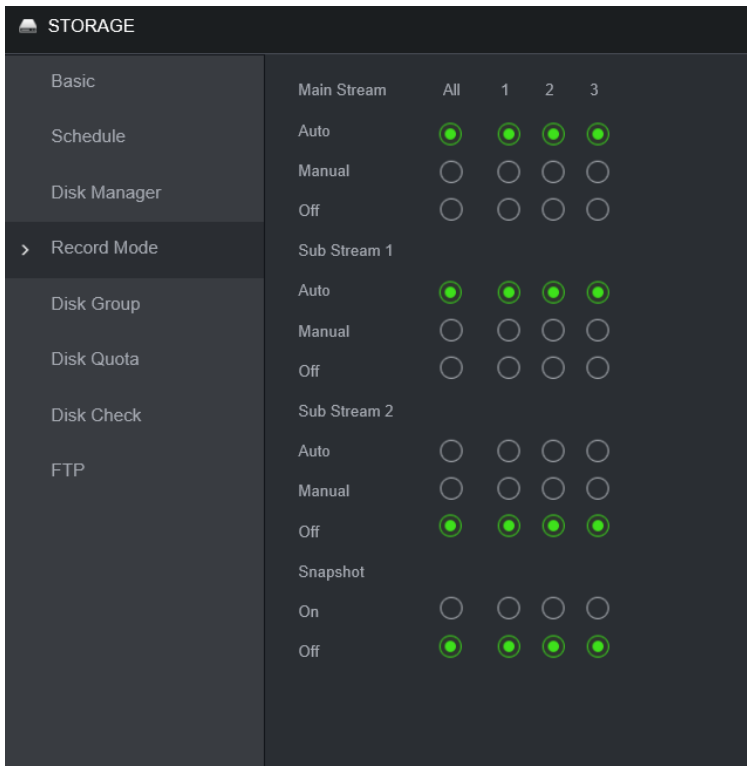

### 6.13.6 Main menu → Administration → Memory → HDD Detected

"Self-Monitoring, Analysis and Reporting Technology (SMART or S.M.A.R.T.) is an industry standard for monitoring hard disk drives (HDD) and solid state drives (SSD) and is used to predict a possible failure of the storage medium. It involves evaluating the values of various sensors using different parameters." \*[1]

Check the status of the hard disk here and start a S.M.A.R.T. check, for example.

**Note:** The hard disk must support this function.

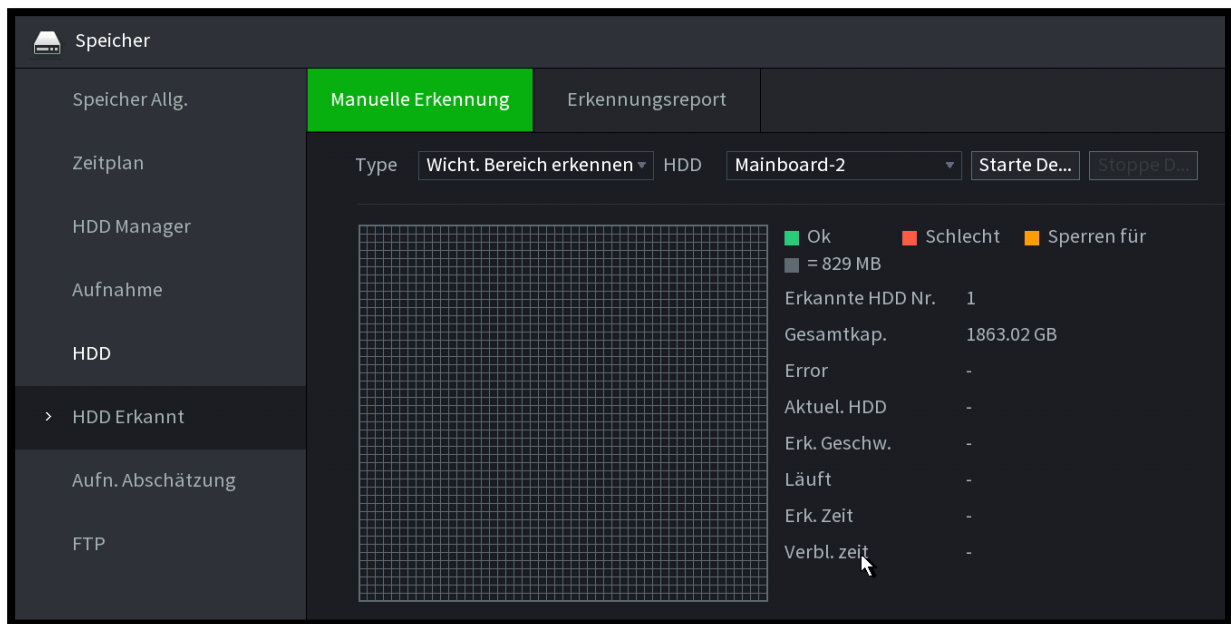

In the recognition report, you can view the reports that have already been recorded in order to arrange for an exchange in good time.

\*[1]: Wikipedia, [https://de.wikipedia.org/wiki/Self-Monitoring,\\_Analysis\\_and\\_Reporting\\_Technology](https://de.wikipedia.org/wiki/Self-Monitoring,_Analysis_and_Reporting_Technology), 20.07.2020,11:50



### 6.13.7 Main menu → Administration → Memory → Recording Estimation

You can use the recording estimation to determine how much storage space you need or how long you can expect the recording to take with the current camera settings.

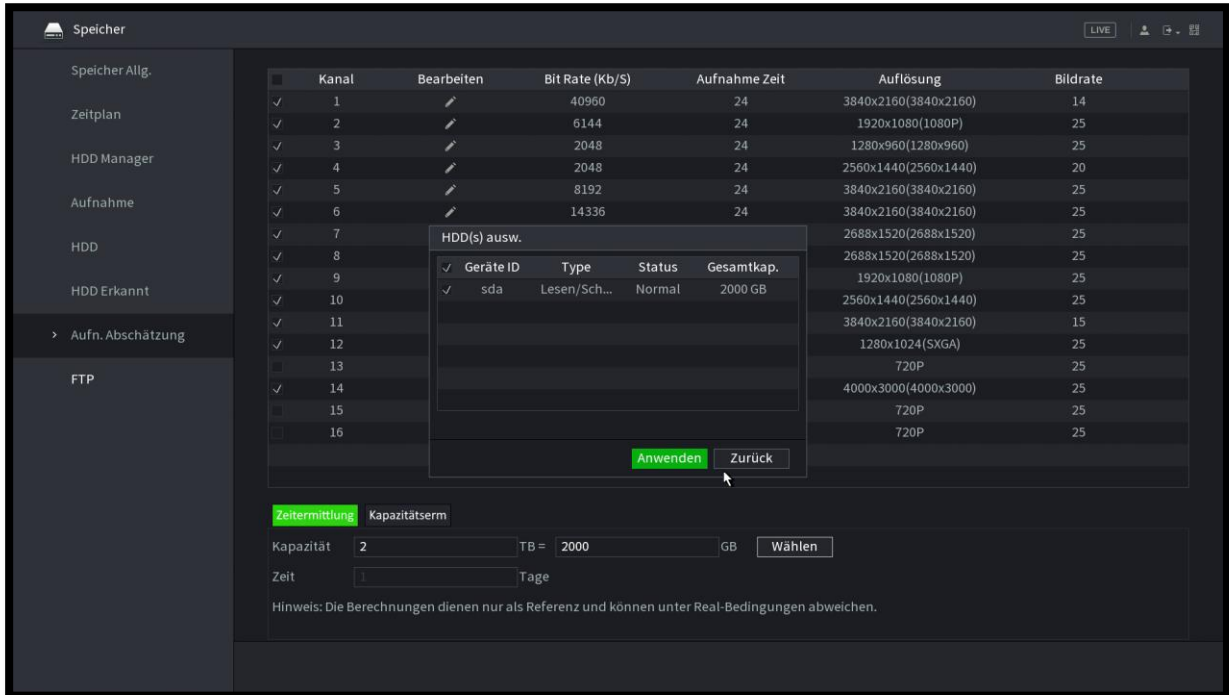

The time/capacity display updates automatically after each changed entry.

### 6.13.8 Main menu → Administration → Storage → FTP

You can use the FTP function to connect the system to an external storage device and thus transfer data to another system.

The screenshot displays the 'STORAGE' configuration page with a sidebar on the left containing options: Basic, Schedule, Disk Manager, Record Mode, Disk Group, Disk Quota, and Disk Check. The 'FTP' option is selected and expanded. The main area is divided into two sections: 'Basic' and 'Record'. In the 'Basic' section, there is an 'Enable' checkbox, radio buttons for 'FTP' and 'SFTP (Recommended)', a 'Server Address' field, a 'Port' field (set to 22), 'Username' and 'Password' fields, an 'Anonymous' checkbox, and a 'Storage Path' field. The 'Record' section includes 'File Size' (0 M), 'Channel' (1), 'Day' (Thu), two 'Period' settings (both 00:00 - 24:00) with 'Event' and 'General' checkboxes, a 'Snapshot' section, 'Picture Upload Interval' (2 sec.), and a 'Channel' button labeled 'Setting'.

The use of SFTP is recommended to ensure the security of your data according to the state of the art.

Anonymous registration should therefore be avoided.

#### Institution

- Enter the FTP server and account data in the upper area.
- In the lower section, set the file size, the recording period and, if necessary, the snapshot interval for the respective selected channel.
- Test the function of the application by clicking on "Test".
- Save the settings with a click on "Apply"

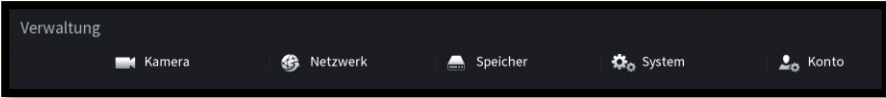
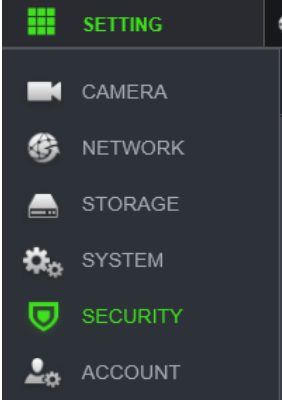

## 6.14 Main menu → Administration → System

Local monitor access	Network access
 <p>(below)</p>	 <p>(top right)</p>

### 6.14.1 Main menu → Administration → System → General settings

Here you can make settings for:

- General
- Date & Time
- Absence

#### 6.14.1.1 General

Set the general system settings here.

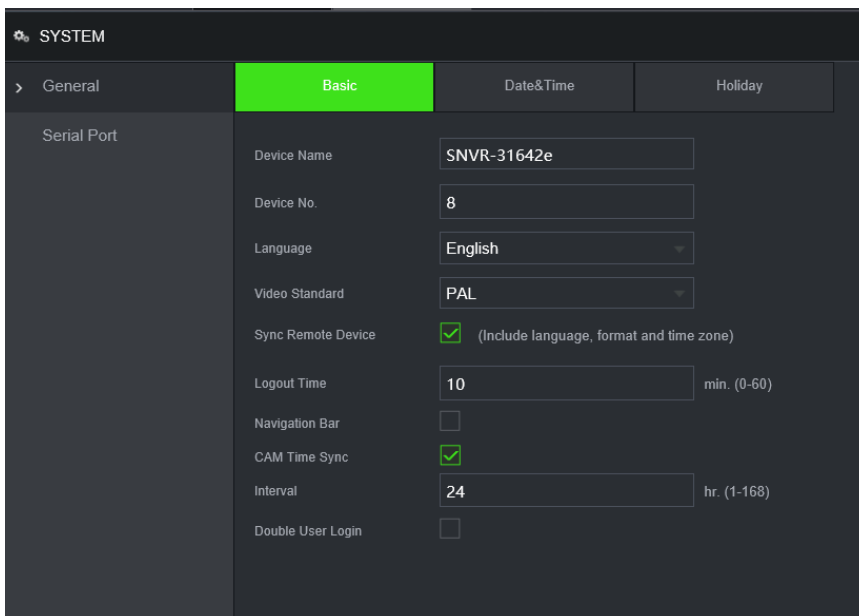

SYSTEM			
General	Basic	Date&Time	Holiday
Serial Port	Device Name	SNVR-31642e	
	Device No.	8	
	Language	English	
	Video Standard	PAL	
	Sync Remote Device	<input checked="" type="checkbox"/> (Include language, format and time zone)	
	Logout Time	10 min. (0-60)	
	Navigation Bar	<input type="checkbox"/>	
	CAM Time Sync	<input checked="" type="checkbox"/>	
	Interval	24 hr. (1-168)	
	Double User Login	<input type="checkbox"/>	

- Device Type | ID:  
Assign a device ID or name via the virtual keyboard.
- Device no.  
Assign a device number via the virtual keyboard.

- **Language:**  
Select the desired language. If you change the language setting, you must restart the recorder.
- **Package length:**  
You can set the recording duration from 1-120 minutes.
- **Fast playback:**  
You can set the real-time playbacks from 5-60 minutes.
- **Auto Logout:**  
Set the time (0-60 minutes) after which the current user is automatically logged out of the recorder if he or she does not work on the recorder during this period. If you want to work on the recorder again after this time, you must log in again with your password.
  - **Live channels**  
Select the channels to be displayed on the monitor even if no user is logged on to the system.
- **Camera time synchronisation:**  
Here you can enter an interval at which the recorder time synchronises with the camera time.
- **Navigation bar:**  
Check this box if you want the navigation bar to be displayed in the live image.
- **4-eyes principle**  
In the context of data protection, it may be advisable to allow system access only in the presence of two administrators (management / works council).
- **Startup Wizard:**  
Check this box if you want the Startup Wizard to appear at the beginning of each recorder restart. If not, you can go directly to the login page.
- **Click speed:**  
Here you can set the speed of the mouse clicks. This is especially important for the double-click speed.



### 6.14.1.2 Date & Time

Here you can set the system time, i.e. the time for the recorder. Setting the correct time is important, e.g. for the time search for events.

You can also set the format of the time and the settings for daylight saving time.

The screenshot shows the 'SYSTEM' configuration page with the 'Date&Time' tab selected. The interface includes a sidebar with 'General' and 'Serial Port' options. The main content area is divided into 'Basic', 'Date&Time', and 'Holiday' sections. The 'Date&Time' section contains the following fields:

- System Time: 2022-12-01 11 : 30 : 59 (with a calendar icon and a 'Sync PC' button)
- Time Zone: (UTC+01:00) Amsterdam, Berlin, Bern, Rom... (with a 'Save' button)
- Date Format: YYYY MM DD
- Date Separator: -
- Time Format: 24-Hour
- DST:
- Type:  Date  Week
- Start Time: Jan 1 00 : 00
- End Time: Jan 2 00 : 00
- NTP:
- Server Address: time.windows.com (with a 'Manual Update' button)
- Port: 123 (with a note '(1-65535)')
- Interval: 60 (with a note 'min.(0-65535)')

### 6.14.1.3 Absence

The defined holidays are listed in this list. To add new days, click on "Add". You can then assign a name and the date.

Click on "Add more" to add more holidays to the list

The screenshot shows the 'SYSTEM' configuration page with the 'Holiday' tab selected. The interface includes a sidebar with 'General' and 'Serial Port' options. The main content area is divided into 'Basic', 'Date&Time', and 'Holiday' sections. The 'Holiday' section contains a table with the following columns:

No.	Status	Name	Date
-----	--------	------	------

At the bottom of the table, there is an 'Add' button.

### 6.14.2 Main menu → Administration → System → RS232

Configure the RS232 interface here. Please note the specifications of the remote station to which you want to connect the system.

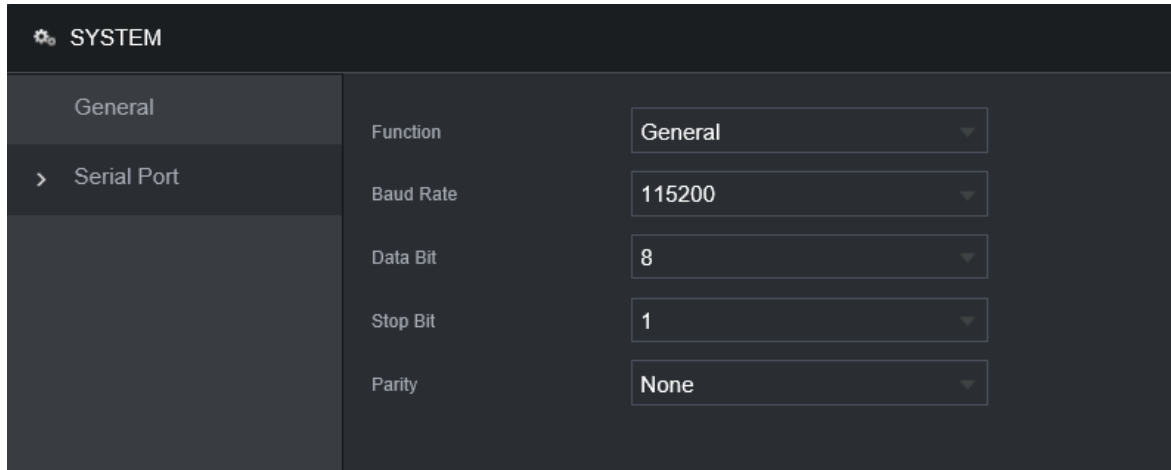

The screenshot shows the 'SYSTEM' configuration menu with a sidebar on the left containing 'General' and 'Serial Port' (selected). The main area displays the following settings:

Parameter	Value
Function	General
Baud Rate	115200
Data Bit	8
Stop Bit	1
Parity	None

- Function
  - Console: Service output
  - PTZ: Control of connected devices
- Baud rate
- Data Bit
- Stop Bit
- Parity

### 6.14.3 Main menu → Administration → System → Security

#### Security settings

An additional way to increase security is to restrict access to the system via the network. Configure white/black lists for systems or network addresses to which you want to allow/block access to the system.

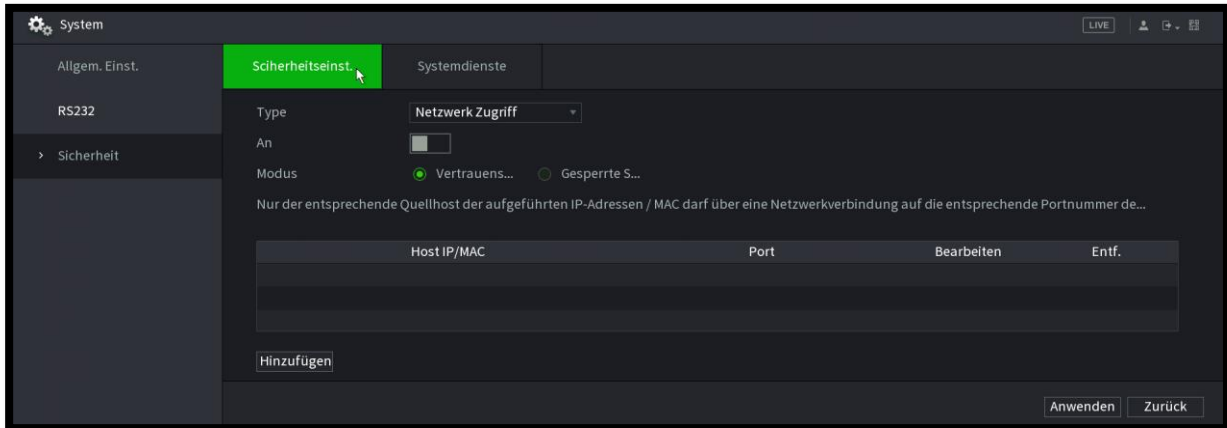

Click on "Add" to enter another system/group of systems in the selected list (Trusted/Locked).

Enter the IP address(es)/MAC address(es) and click "Apply".

Activate the function by switching the slider to "On".

## System services

In the system services menu, functions are listed which may not be absolutely necessary. You can deactivate these if you do not use the functions (e.g. ONVIF).

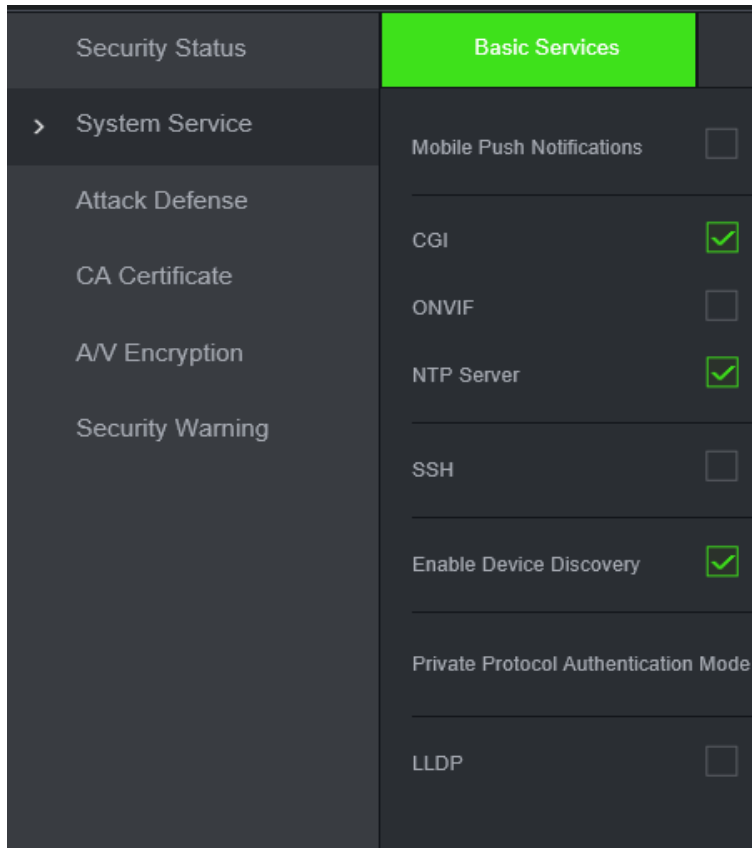

It is recommended to use the BURG-GUARD / BURG-WÄCHTER own protocol for the device connection. If you only use this protocol, you can deactivate ONVIF.

If audio/video encryption is activated, only BURG-GUARD / BURG-WÄCHTER devices with the same key can be connected to each other.

Recommendation: Activate the encryption function if you only use BURG-GUARD / BURG-WÄCHTER devices.





## 6.15 Main menu → Administration → Account

- Here you can manage and set up users or user groups.
- The list shows the users or groups.
- You can edit the user/group by clicking on the pencil icon behind the respective user/group. You can delete the user/group by clicking on the cross behind the respective user/group.
- Click on "Add user" or "Add group".
- A maximum of 64 users and 20 groups can be defined.

### 6.15.1 Main menu → Administration → Account → User

No.	Username	Group Name	Password Strength	MAC Address	Remarks	Modify	Delete
1	admin	admin	Medium		admin's account		

To create a new user click on "+ User".

**Modify**

Username: admin

Group: admin

Remarks: admin's account

User MAC: : : : : :

Modify Password:

Old Password:

New Password:

Confirm Password:

Password Expires in: Never

Permission: System

Buttons: Search, Live, OK, Cancel

Assign a user name and password, then define the rights that the user is to receive.

**Note:** The selection of possible rights depends on the group membership.

### 6.15.2 Main menu → Administration → Account → Group

The following can be defined for each user/group:

- Username
- Set password or assign new password (via the virtual keyboard)
- Membership of a user in a group
- "Reusable": If activated, several users can use the same account for login.
- Definition of powers/rights:
  - Access to system functions, e.g. PTZ, camera, event, shutdown, etc.
  - Access to playback of individual channels
  - Access to the monitor (display) of individual channels

### 6.15.3 Main menu → Administration → Account → Reset password

Specify the conditions under which resetting the system password is permitted.

1. Reset via administrator e-mail address (recommended)  
If you forget the system password, you can reset the password in this way using the QR code and the BURGcam PRO app.
2. Answering 3 personal questions  
You can reset the system password by correctly entering 3 personal answers.

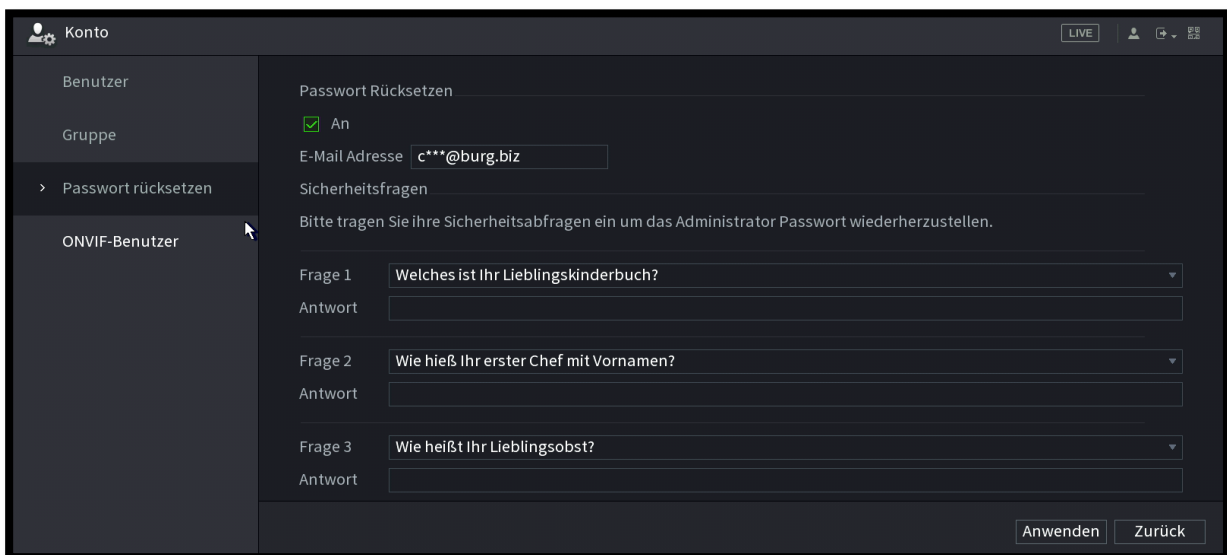

The screenshot shows a web interface for user management. The left sidebar contains a menu with 'Konto' at the top, followed by 'Benutzer', 'Gruppe', 'Passwort rücksetzen', and 'ONVIF-Benutzer'. The main content area is titled 'Passwort Rücksetzen' and includes a toggle switch for 'An' (checked), an 'E-Mail Adresse' field with the value 'c\*\*\*@burg.biz', and a section for 'Sicherheitsfragen' (Security Questions). Three questions are listed, each with a dropdown menu and an 'Antwort' (Answer) field: 'Frage 1: Welches ist Ihr Lieblingskinderbuch?', 'Frage 2: Wie hieß Ihr erster Chef mit Vornamen?', and 'Frage 3: Wie heißt Ihr Lieblingsobst?'. At the bottom right, there are 'Anwenden' and 'Zurück' buttons.

## 7. Network access

### 7.1 Remote Access: Access to the recorder via the web

#### 7.1.1 Establish network connection

You can also access the recorder remotely via the web. To do this, please make the following preparations:

1. Start the recorder as usual.
2. Connect the recorder to the network using a LAN cable.
3. Open the main menu on the recorder:  
Main menu → Settings → Network → TCP/IP  
Click on the pencil icon ("Edit") behind "Ethernet Card1".  
Place a tick next to "DHCP".  
Click on "Save".
4. Please open the following menu:  
Main menu → Info → Network → Network test  
The assigned IP address is now displayed here, e.g. 192.168.0.108.  
You need the IP address of the recorder displayed here for access via the web.

#### 7.1.2 Login via web

You have 2 options for accessing the recorder via web access:

#### 7.1.3 Find a device in the network

After connecting the unit to your computer/switch/router, install the "BW IP ConfigTool" (configuration tool) supplied on the CD on your computer.

#### Notes:

- If you are using the ConfigTool for the first time, you must first agree to the installation.
- You can find the latest version of the ConfigTool on our homepage.

Start the ConfigTool and click on "Refresh" to search for cameras in the network. The devices connected to the network are automatically found and listed with the respective IP address.

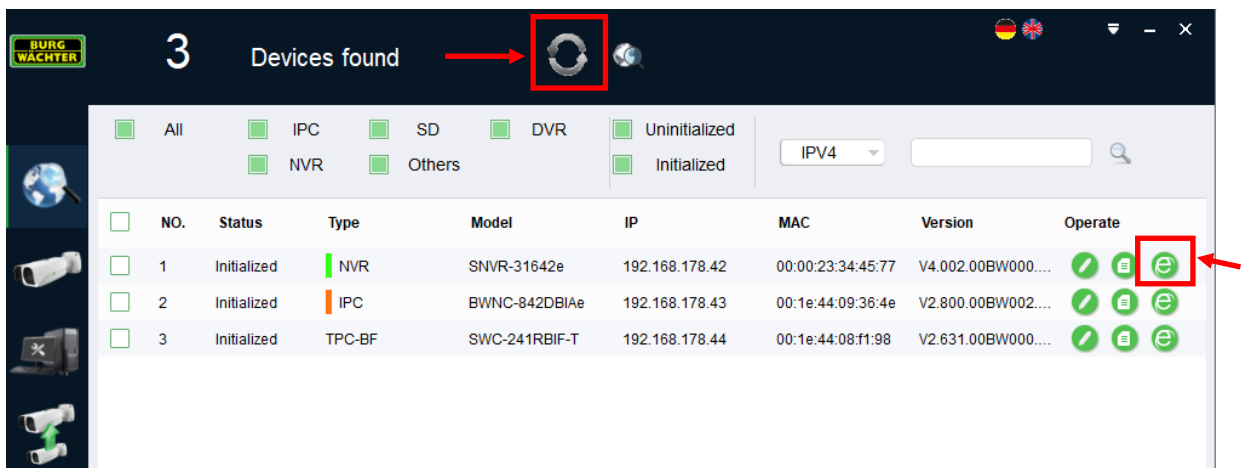



Click on the explorer symbol in the camera list to access the web interface of the camera.

If there is no DHCP server, you can usually access the website of the unit via the default address: 192.168.0.108.

Note: PC and unit must be in the same address range.

#### **7.1.4 Manual entry of the IP address via the web browser:**

- After you have completed these preparations, now open the web browser on your PC, e.g. Internet Explorer, Safari, Firefox.
- In the address line of your web browser, enter the IP address of the recorder (see above). Example: <http://192.168.1.108>
- When you first access the recorder via the web, you will be prompted to install a plug-in, confirm it and run it.



## 7.1.5 Login

It does not matter whether you want to access the recorder via the web browser or via the ConfigTool: In both cases, the login window appears.

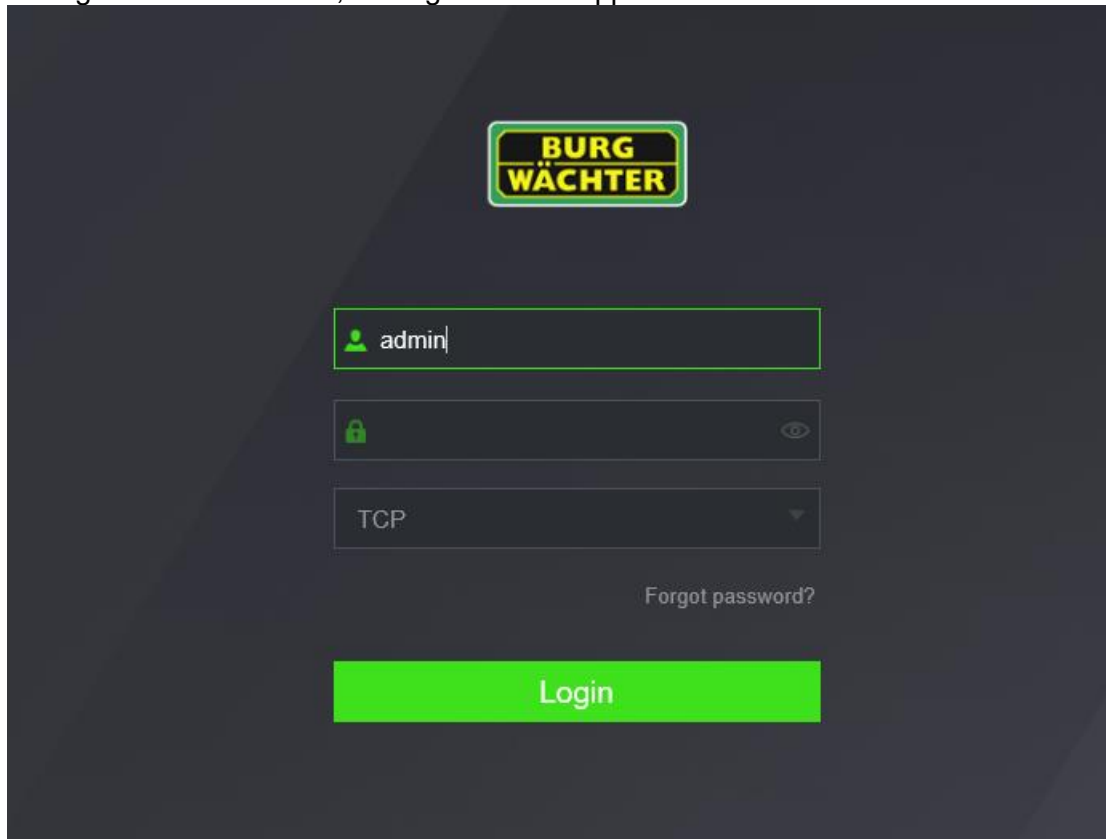

You can choose between "LAN" and "WAN" connection type.

**When you log in for the first time, you will be asked to enter a user name and password. Please make sure that you use a secure password. The probable security is shown in the bar chart. Passwords that are considered insecure cannot be used.**

Hint:

You can view, change and delete the login information here:

Main menu → Administration → Account

The live view of the video image appears.

The view and menu navigation are structured and displayed slightly differently in the web view, but the setting options are analogous to the functions described here in the operating instructions.

### 7.1.6 Security

The "Safety" menu is used by the installer and operator to compare the minimum safety requirements of the system.

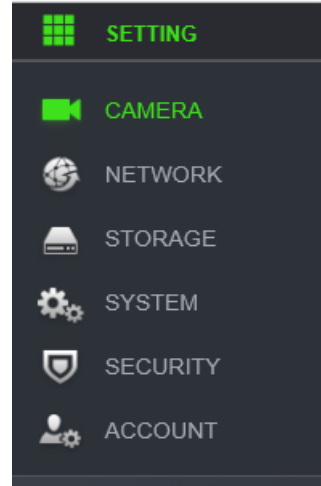

Select "Setup" > "Security" in the main menu (top left)

In the security status you will find the overview of the settings that can be checked by the system.

Green: System setting meets the minimum requirements

Orange: System does not meet minimum requirements

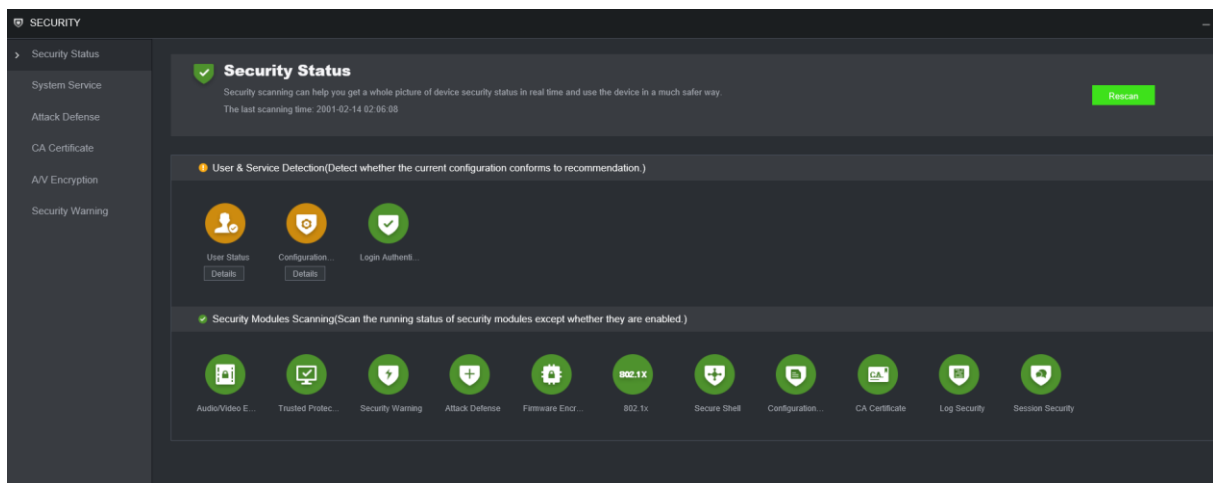

You can use the "Check" button to update the confirmation prompt and check the status again. Please note that the system can only check on the basis of the creation date of the present device firmware.



### 7.1.6.1 System services Basic settings

In the system services menu, functions are listed which may not be absolutely necessary. You can deactivate these if you do not use the functions (e.g. ONVIF).

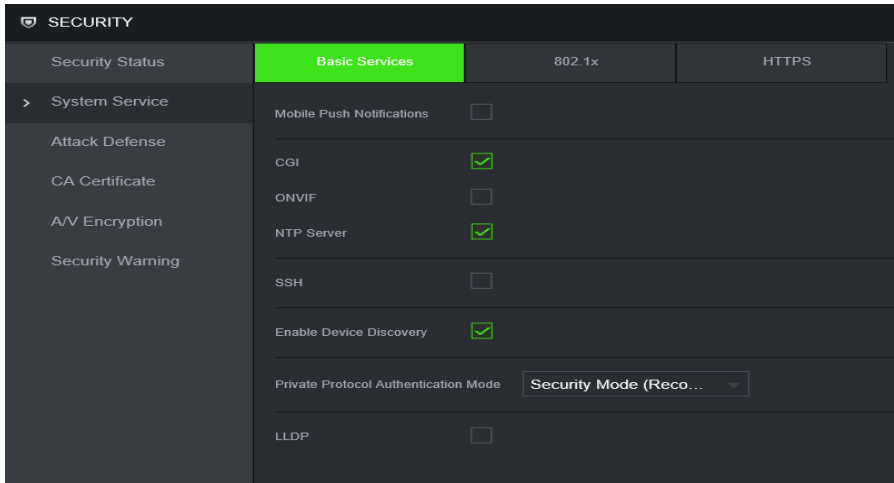

It is recommended to use the BURG-GUARD / BURG-WÄCHTER own protocol for the device connection. If you only use this protocol, you can deactivate ONVIF.

If audio/video encryption is activated, only BURG-GUARD / BURG-WÄCHTER devices with the same key can be connected to each other.

Recommendation: Activate the encryption function if you only use BURG-GUARD / BURG-WÄCHTER devices.

### 802.1x

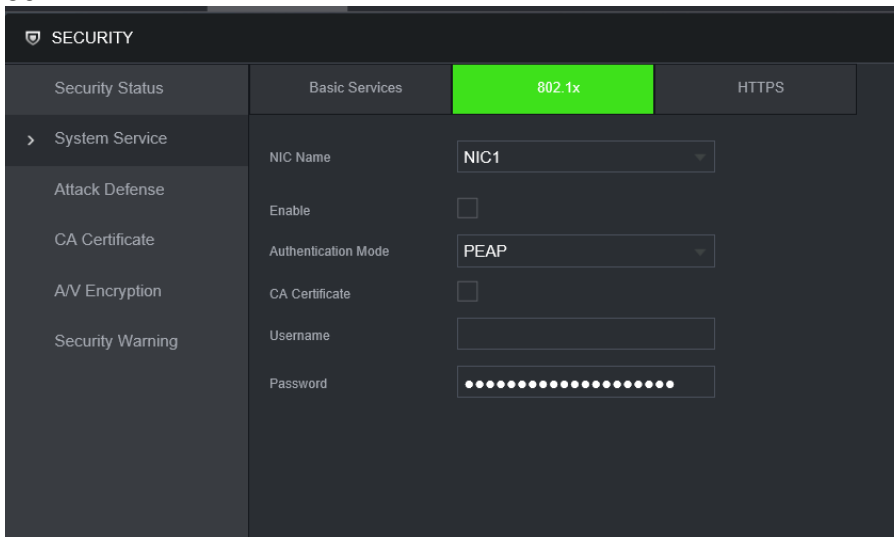

The Protected Extensible Authentication Protocol (PEAP) is intended to provide more security for authentication in LANs. Its use is recommended in the IEEE 802.1X standard, which generally regulates authentication in computer networks.

## HTTPS

To enhance system security, the Web, ONVIF, RTSP, CGI service can be accessed via HTTPS.

You can use the pre-installed HTTPS certificate, create your own certificate or import an existing one into the system.

Recommendation: Use HTTPS to increase the security of your system. HTTPS is standard and should therefore always be used.

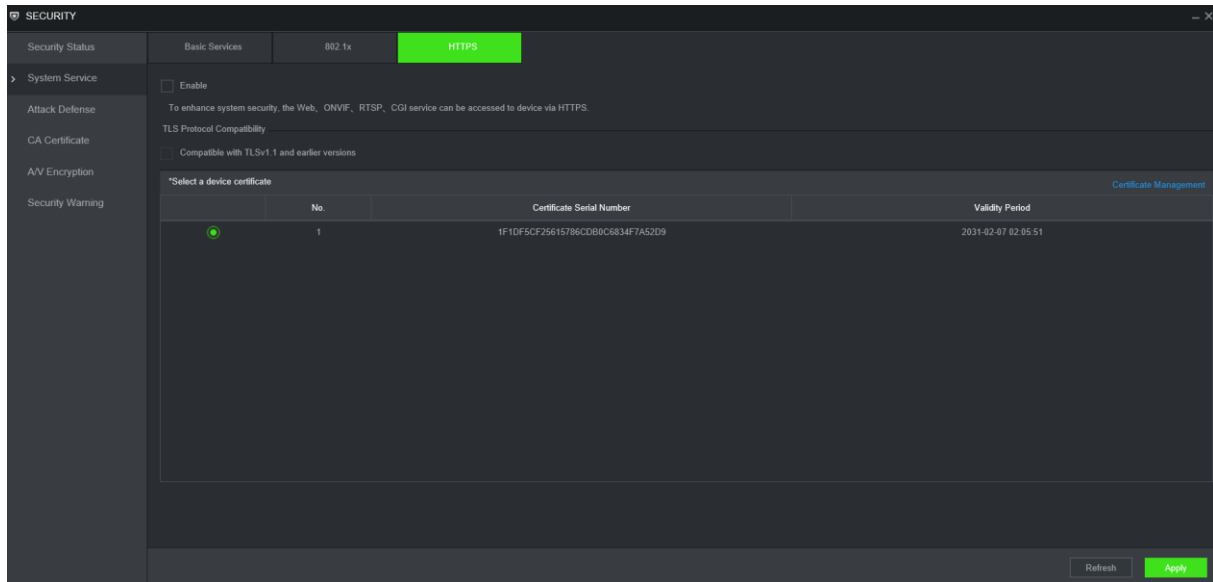

To download the already installed certificate click on "Certificate Management" or select "CA Certificate" in the menu on the left.





### 7.1.6.2 Attack defence

Protect your system from unauthorised access. The following settings are provided for this purpose:

- IP Filter
- Account blocking
- Anti-DoS attack
- Sync Time - Whitelist

#### IP Filter

Using IP filters, you can explicitly enable or block devices for access to the system.

To do this, enter the IP/Mac address of the system or the IP circle in the corresponding list (Whitelist / Blacklist).

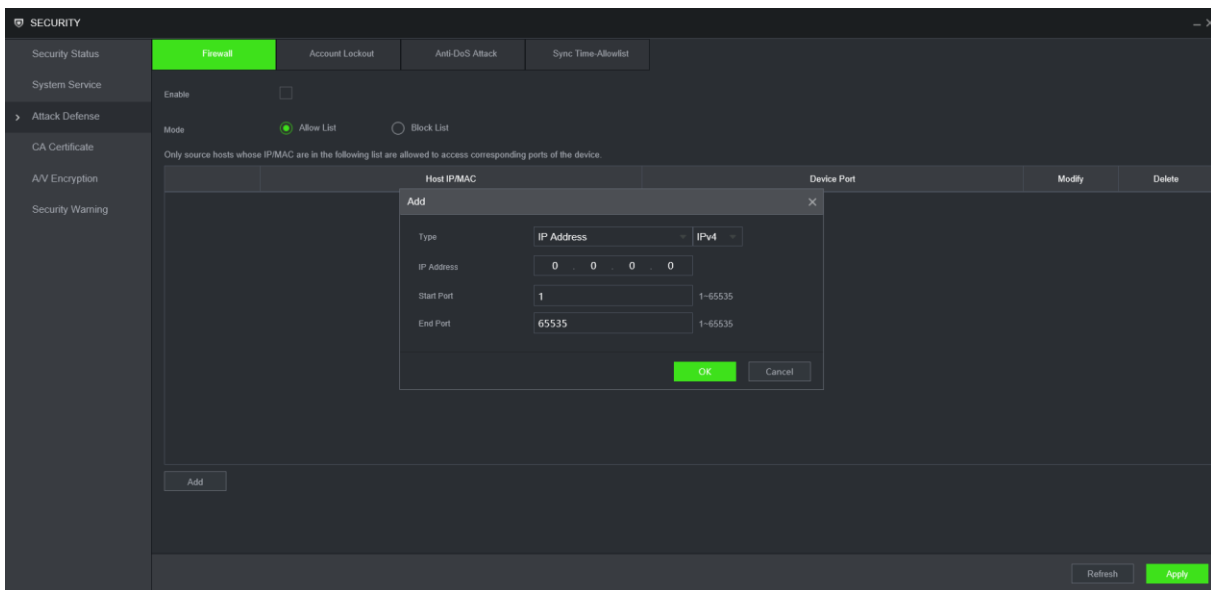

#### Account blocking

Configure the account lockout according to your requirements. You can set the duration of the lock and the number of attempts until the lock time is activated.

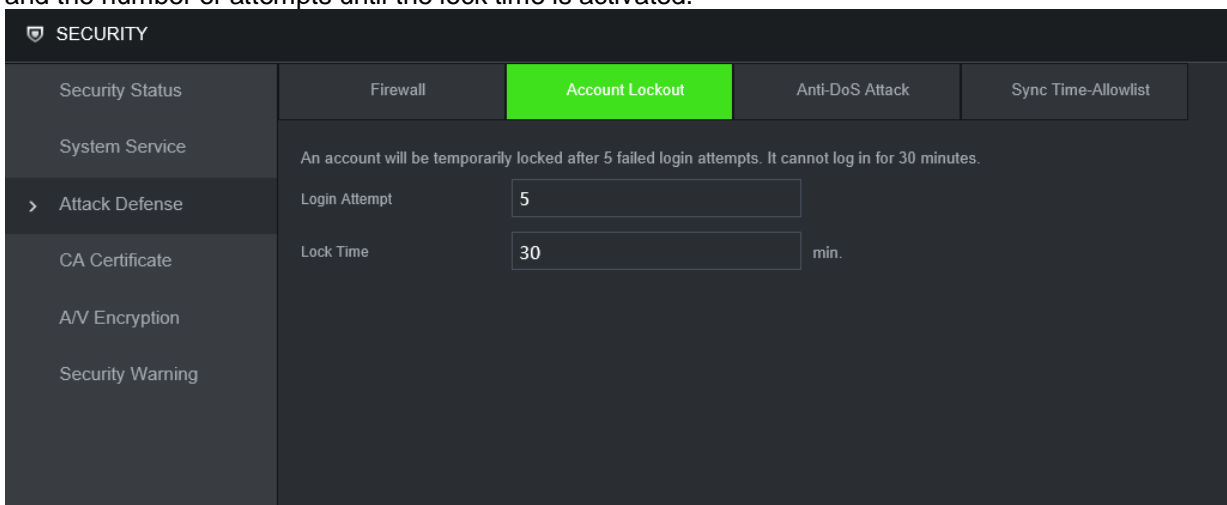

## Anti-DoS attack

The following functions are available to defend against DoS attacks:

SYN defence: When activated, the system discards SYN flood messages to counteract overload.

ICMP defence: The system detects unusually high amounts of ICMP packets and filters them so that an overload is avoided.

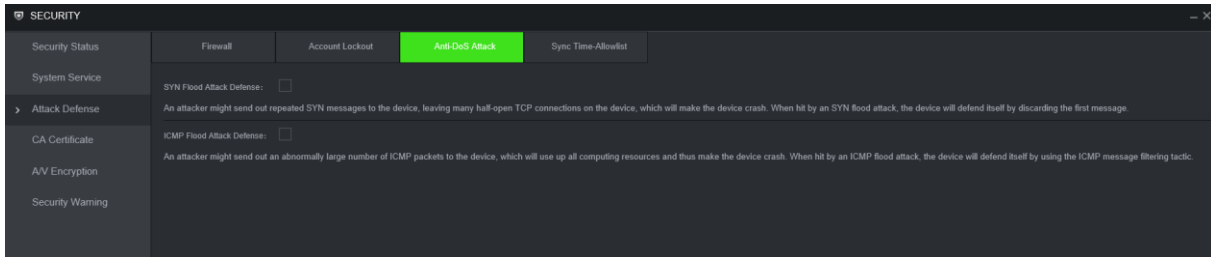

Note: Activating the functions requires system performance and affects, among other things, the real-time capability of the system.

## Sync Time Whitelist

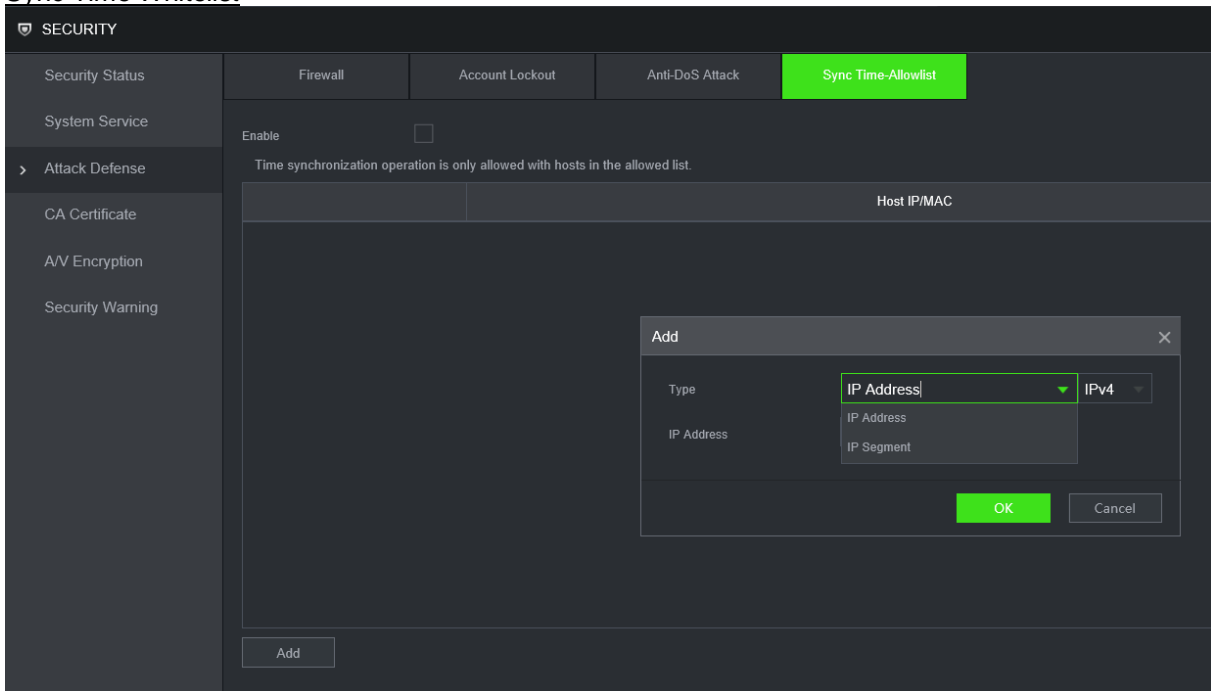

If the Sync-Time Whitelist is activated, time synchronisation only takes place with the listed devices. Click on "Add" to add a device per IP or devices per IP circle to the list.

### 7.1.6.3 CA Certificate

CA Certificates are required to establish a secure connection between two devices. In this menu you can create your own certificates, import existing ones or integrate third-party certificates.

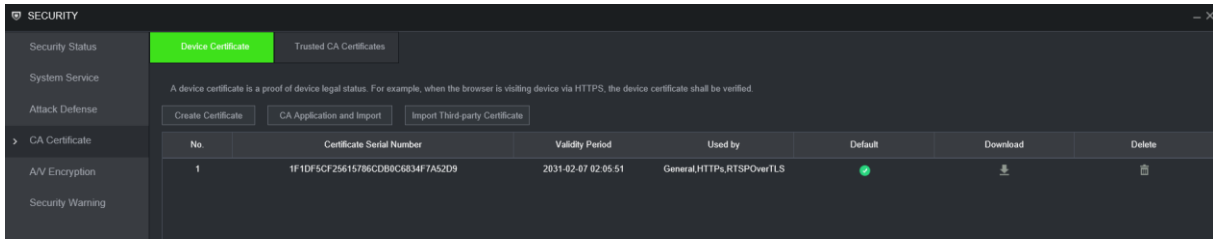

To use the existing certificate, please download it to your PC by clicking on the download icon and install it in the certificate store.

To do this, right-click on the downloaded certificate and then select "Install certificate".

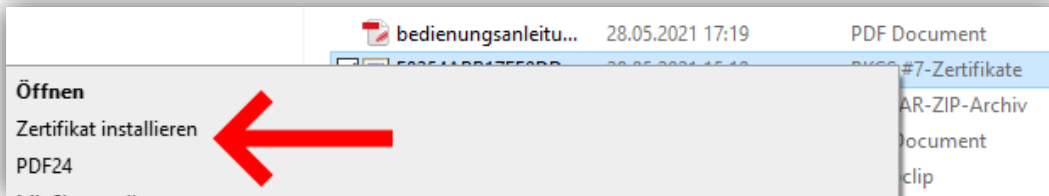

Follow the steps through the certificate import wizard and enable HTTPS in the device settings.

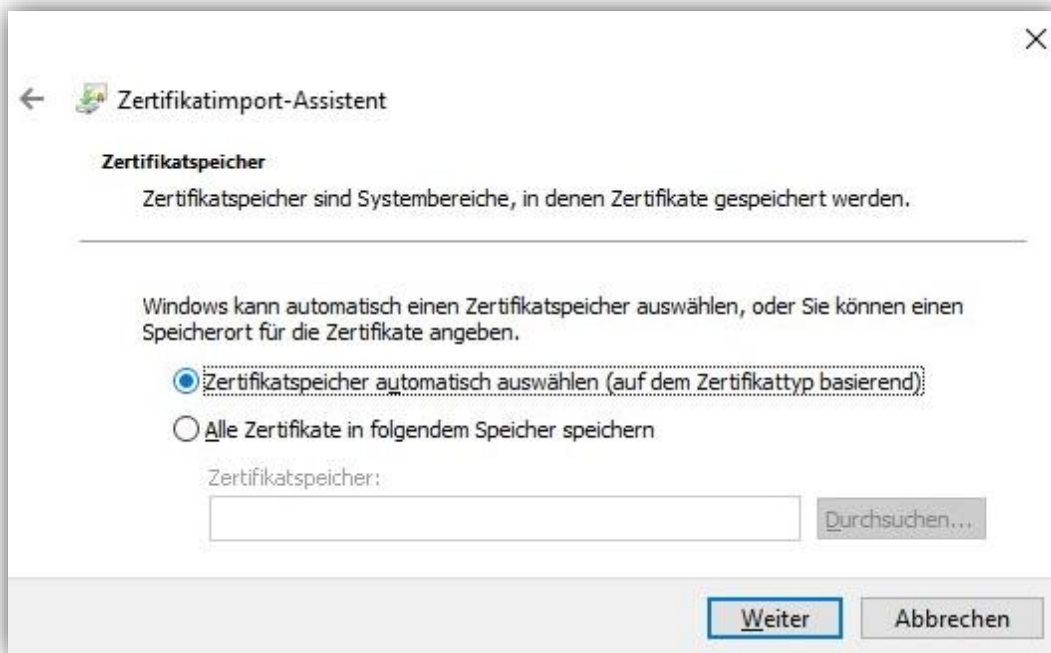



### Use existing certificate

To import certificates, please select the appropriate button and follow the set-up steps.

### Create certificate

To create a certificate, select the button "Create certificate" and fill in the required data individually.

Region	DE
Province	NRW
City Name	Meinerzhagen
Validity Period	999
Organization	BUR-GUARD GmbH
Organization Unit	Rnd
IP/Domain Name	192.168.178.42

Buttons: Create, Cancel

Then click on Create to generate the certificate automatically.

You can download and install/transfer the certificate after it has been successfully created.



### 7.1.6.4 Audio/Video Encryption

Activate the encrypted transmission of audio and video signals to increase the security of your system. Make sure that the connected devices use the same protocol/certificate, otherwise decryption cannot take place.

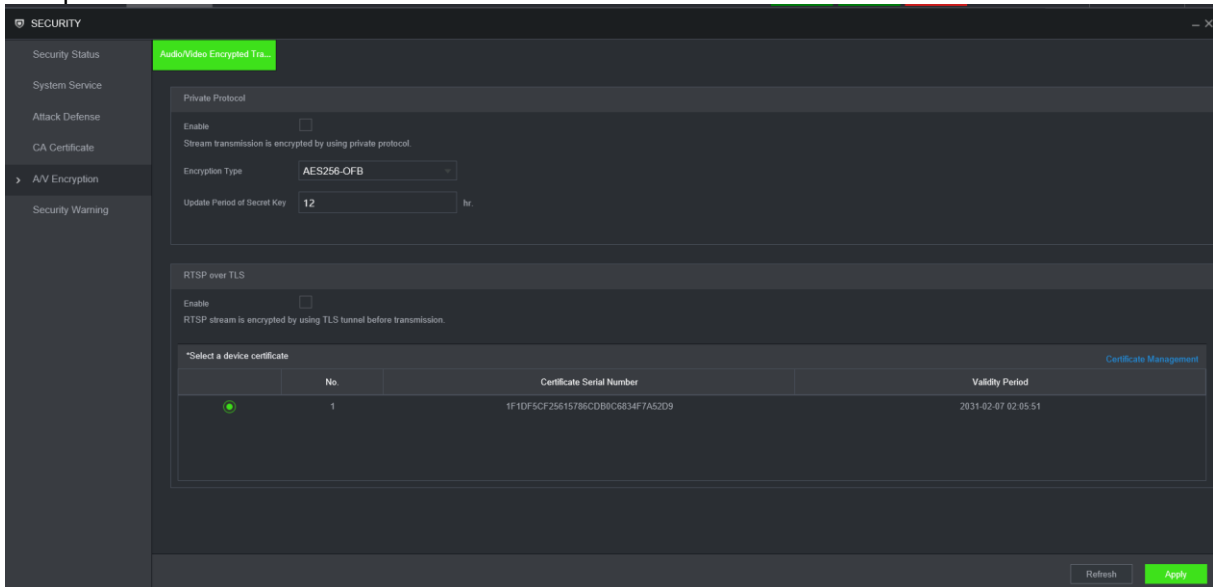

### 7.1.6.5 Safety warning

In the menu settings for the security warning and the illegal login, you can select how such an event is to be handled.

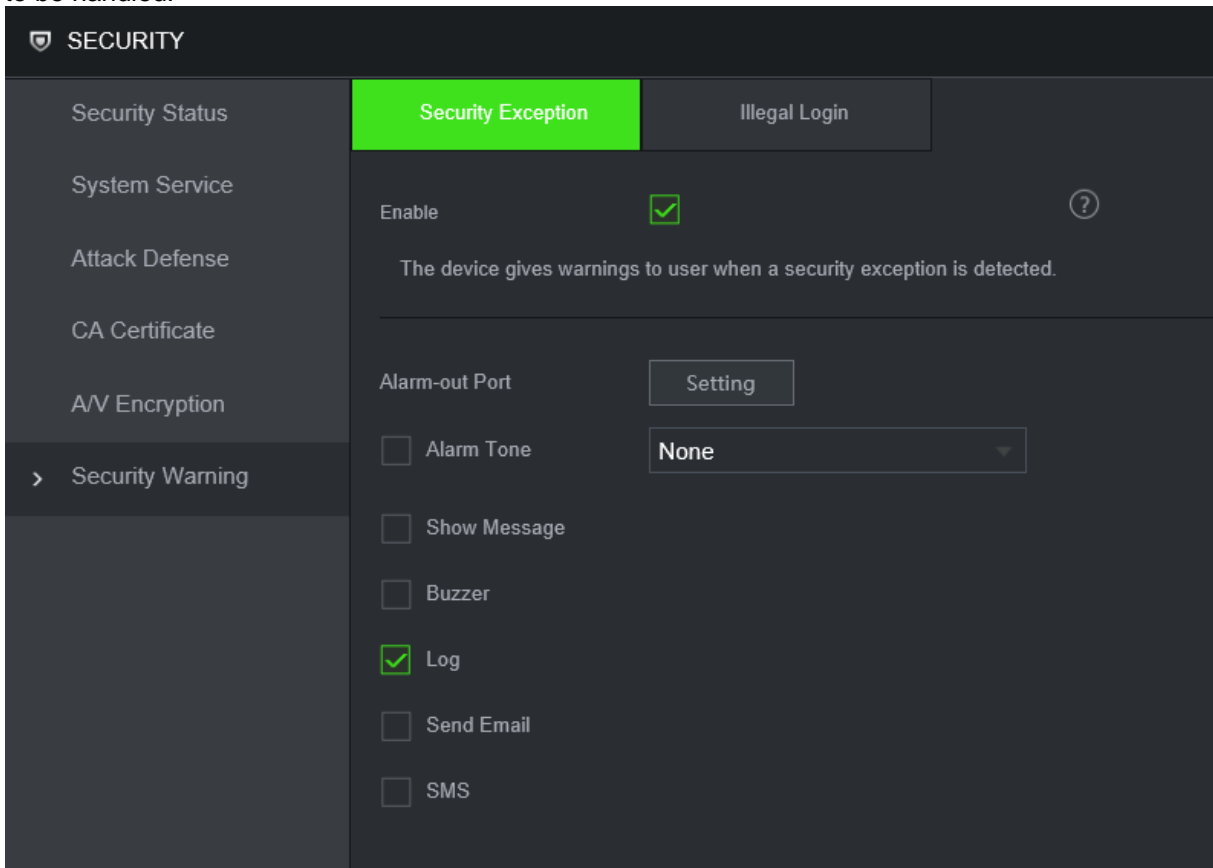

## 8. Remote connections

### 8.1 BURGcam App - P2P

To access your device via the app, you must connect it to a network that has access to the Internet. If you activate the P2P function, the system establishes a connection to the BURGcloud P2P server. If the connection is successfully established, the status changes to "Online" within one minute.

The system can then be integrated into your app, e.g. by scanning the QR code. You can find the P2P QR code for integration into the app at:

- Administration → Network P2P Setting
- QR Code (top right)
- On the appliance label

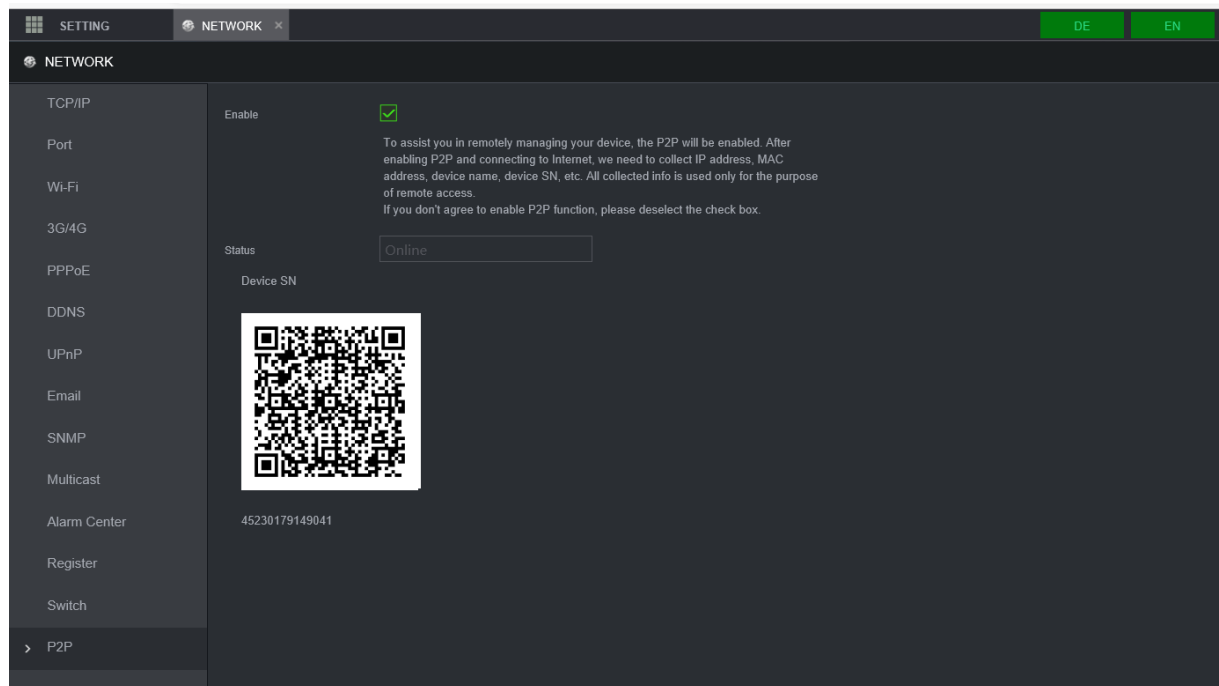

Alternatively, you can also manually search for the system in the network in the app or enter the serial number.

#### Notes on the P2P connection

If the connection to the P2P server is not established, please check the following step by step:

- 1) Check whether you can establish a connection via the IP [not P2P] in the local network with your smartphone/tablet using the installed BURGcam PRO app.
- 2) Under Settings → Network → TCP/IP, enter the IP "8.8.8.8" for "Preferred DNS Server" and the IP "8.8.4.4" for "Alternate DNS Server". Check the connection setup again.
- 3) Make sure your machine is connected to the router/Internet. Check:
  - Is the IP address correct, not assigned twice?
  - Is the machine on a free network port (not a guest network)?
  - Are port or rights restrictions active in the router for the device/IP?
  - Is a proxy server active that blocks the connection?
  - Is the device on the same network as the router?

## Notes on the disposal of the appliance

Please observe the applicable legal regulations in the case of disposal of unusable equipment.



This symbol means that electrical and electronic equipment must be disposed of separately from household waste at the end of its useful life. Please dispose of the appliance at your local municipal collection point.

## Imprint

The copyright of these operating instructions is held exclusively by BURG-GUARD GMBH. Any reproduction, including on electronic data carriers, requires the written consent of BURG-GUARD GMBH. Reprinting - even of extracts - is prohibited.

Errors and technical modifications excepted.

BURG-GUARD is a registered trademark of BURG-GUARD GMBH. Other company and product names that may be mentioned are trademarks or registered trademarks or brands of the respective owners.

© Copyright:  
BURG-GUARD GMBH  
Wormgermühle  
58540 Meinerzhagen  
Germany  
[www.burg-guard.com](http://www.burg-guard.com)

Your specialist dealer: