

**Contact Us: FACTORY UTV LLC**

9237 Beatty Drive Sacramento, CA 95826

Phone : (916) 383-2730

E-mail : [info@factoryutv.net](mailto:info@factoryutv.net)

Go online: [www.Factoryutv.net](http://www.Factoryutv.net)



## **U.H.M.W. Skid Plate / Under Armor Package**

*Ultra. High. Molecular. Weight. polyethylene all terrain skid plate / under armor kit for UTV's*

### **Installation Guide ( Skid Plate and Rocksliders)**

***Polaris***

***RZR 4 900 ( 2014 - 2021+)***

***Fits: RZR 4 900 EPS - 4 900 S - 4 1000 S***



# Factory UTV Polaris RZR 4 900 (2014 - 2021+) Instructions

Remove stock skid plate and re-use stock hardware as needed in all ( A ) locations.

May need the use of a car jack and clamps to aid during install, Skid's will form to vehicle during installation.

- #1** **Chassis Frame Mounts:**  
Install (4x) angle brackets using 4x of the stock self tapping bolts, thread in to chassis frame ( A ) locations.  
Install Cross member : Use (1x) stock bolt in center (A) location, (2x) "D" clamps W/ (2x) M6- 1.0 x 20mm Flange Bolt in ( E ) locations

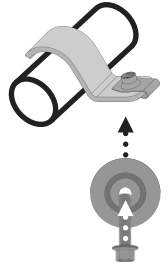
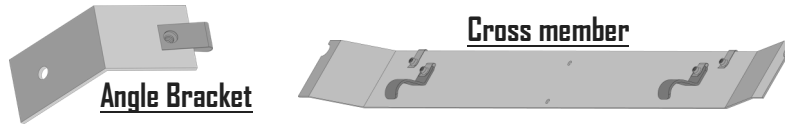

- #2** **Main and Mid Skid Plates :**  
Install mid skid 2<sub>(b)</sub> before main skid 2<sub>(a)</sub>, align edges. Use: ( 8x ) Stock Bolts in : ( A ) locations.  
Install: ( 4x ) M6-1.0 x 25mm Flange Bolts with "D" Clamps in Main Skid 2<sub>(a)</sub> : ( D ) locations.  
Install: ( 6x ) M6-1.0 x 20mm Flange Bolts in Main and Mid Skid : ( E ) locations. (in angle bracket locations)  
Defer side ( B\* ) locations Until Step (#5)

- #3** **Rear Skid Plate :**  
Align edge with mid skid plate 2<sub>(b)</sub>  
Install: ( 2x ) M6- 1.0 x 30mm Flange Bolts in Rear Skid : ( F ) locations.  
\*(See Drilling Instructions Below)\* Align, mark, drill, and  
Install: ( 3x ) 1/4" -20 x 1" Self Tapping Bolts, in Rear Skid : ( B ) locations.



- #4** **Front Diff. Skid Plate :**  
\*(See Drilling Instructions Below)\* Align edge with Main Skid 2<sub>(a)</sub>.  
Mark, drill and install: (4x) 1/4" -20 x 3/4" Self Tapping Bolts in Front Diff. Skid : ( C ) locations.



- #5** **Side Mounts ( B ):**  
\*(See Drilling Instructions Below)\*  
Align, mark, drill, and Install: (16x) 1/4" -20 x 1" Self Tapping Bolts in Main Skid : ( B ) locations.

- RS** **If Rock Sliders ( B\* ) :**  
Place Rock sliders in-between skid and chassis frame. Using the same skid mounting locations,  
install: (16x) 1/4" -20 x 1 1/4" Self Tapping Bolts, "RS" bolts, In main and mid skid : ( B\* ) locations.  
( In lieu of (16) (1/4" -20 x 1" Self Tapping Bolts) side bolts. )



## **\* Drilling Instructions : \***

Use a : #N $\text{\textcircled{7}}$  ( 13/64<sup>th</sup> ) drill bit,

( one size above the commonly available 3/16<sup>th</sup> bit ) Recommended 1/4" - 20 Tap \*(Optional)

To drill and thread self tapping bolts in to chassis frame.

Finger Thread All Bolts Prior To Fastening Securely With Power Tools.

We strongly recommend the use of a "Thread Locking Compound" when installing any mounting hardware.

( When installation is complete , ensure all bolts are fastened securely.)

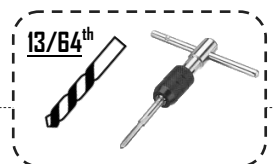

( 1/4" -20 ) Tap  
Recommended for  
\*drilled locations

# Polaris RZR 4 900 (2014 - 2021+) Instructions

(RZR 4 900 EPS - 4 900 S - 4 1000 S)

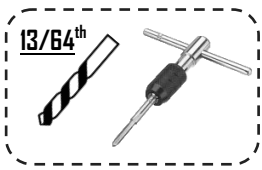

13/64<sup>th</sup>  
 (1/4"-20) Tap  
 Recommended for  
 \*drilled locations



\* (Align edges)

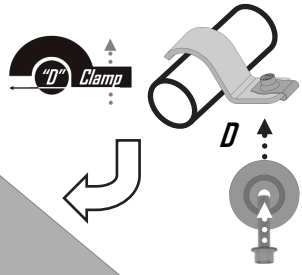

"D" Clamp

Remove stock skid plate.  
 Re-use stock hardware.  
 Install all mounting brackets first.  
 Tighten skid bolts loosely for install  
 adjustments as needed.  
 fasten all bolts securely  
 when complete.

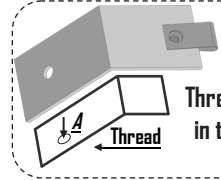

Angle Bracket  
 Thread stock self tapping "A" bolts  
 in to un-threaded holes in frame.

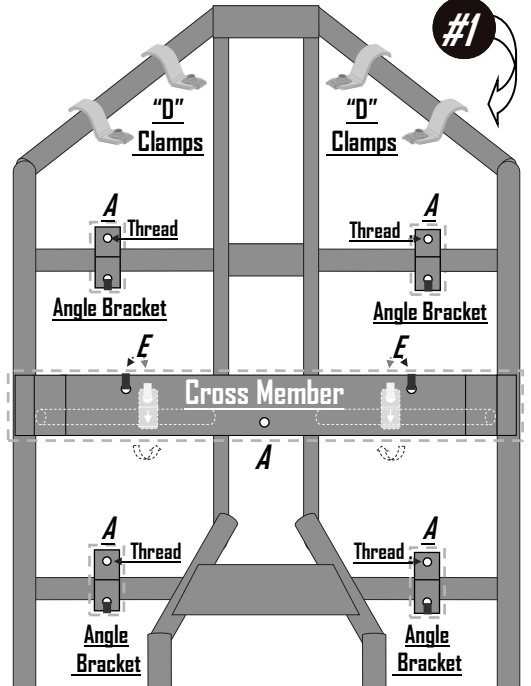
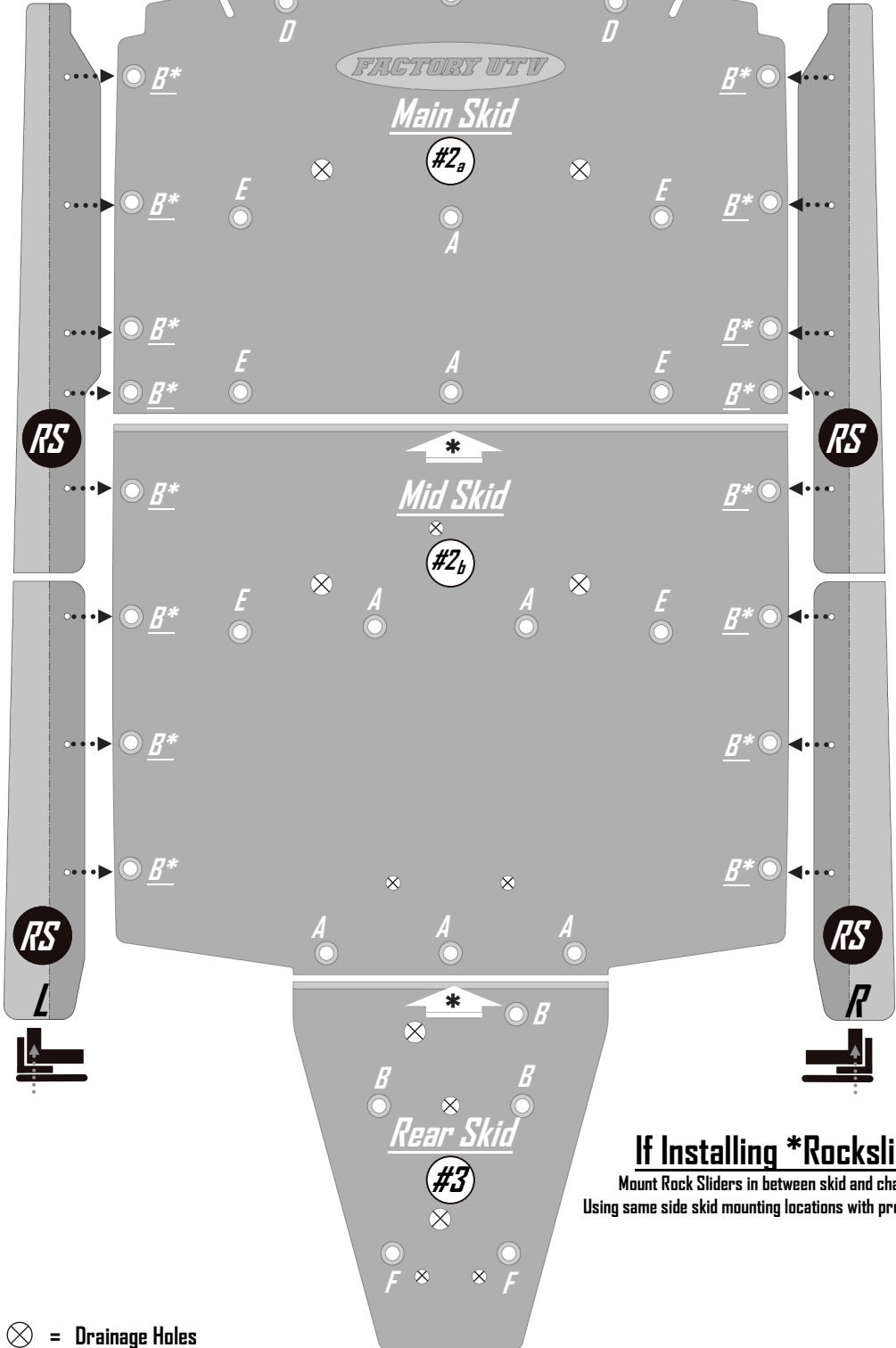

Bolt D clamps on to Cross Member,  
 flip and mount on to chassis frame

"\_" Underscore locations  
 require drilling.

"\*" Star locations can use RS bolts

## If Installing \*Rocksliders

Mount Rock Sliders in between skid and chassis frame.  
 Using same side skid mounting locations with provide (RS) bolts.



Use of clamps and/or  
 Floor jack may aid in installation.

⊗ = Drainage Holes  
 Do Not Use For Mounting

# Factory UTV Polaris RZR 4 900 (2014 - 2021+) Hardware

(RZR 4 900 EPS - 4 900 S - 4 1000 S)

**#1** Front Diff Skid Small Bag

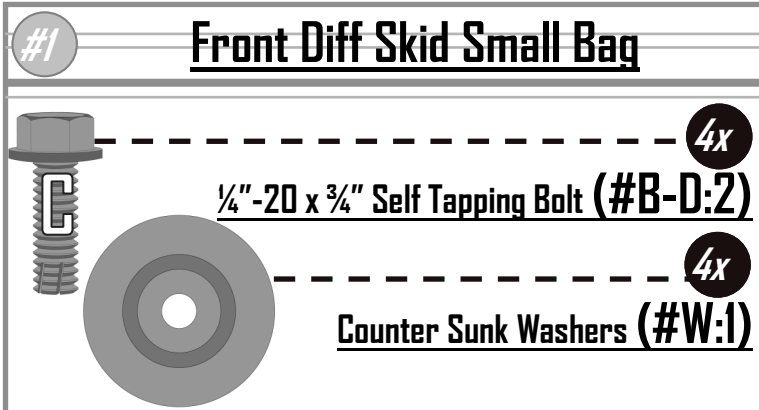

4x  $\frac{1}{4}$ "-20 x  $\frac{3}{4}$ " Self Tapping Bolt (#B-D:2)

4x Counter Sunk Washers (#W:1)

**#1** Main Skid Small Bag

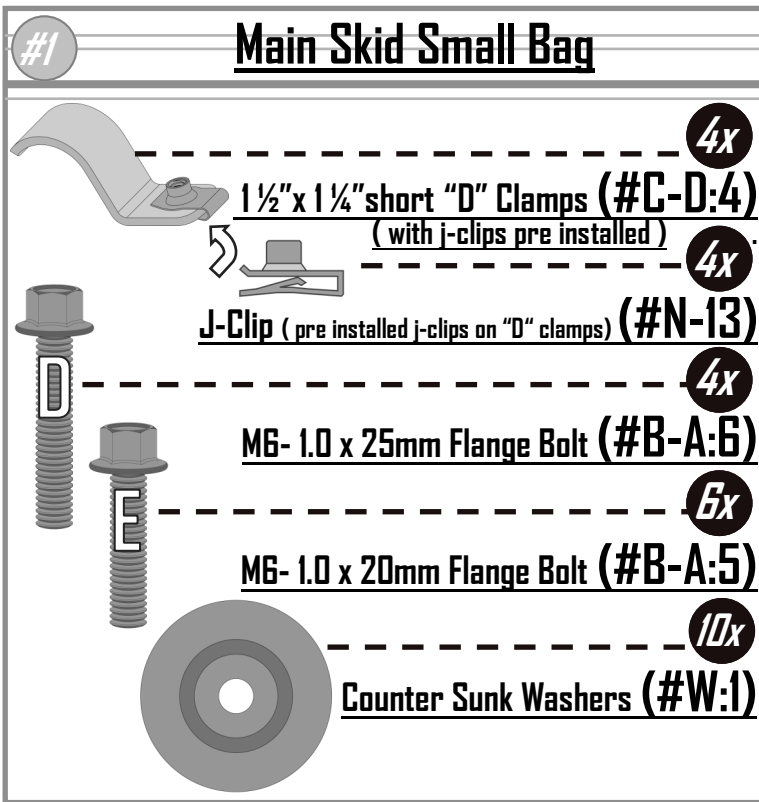

4x  $1\frac{1}{2}$ " x  $1\frac{1}{4}$ " short "D" Clamps (#C-D:4)  
(with j-clips pre installed)

4x J-Clip (pre installed j-clips on "D" clamps) (#N-13)

4x M6- 1.0 x 25mm Flange Bolt (#B-A:6)

6x M6- 1.0 x 20mm Flange Bolt (#B-A:5)

10x Counter Sunk Washers (#W:1)

**#1** Rear Skid Small Bag

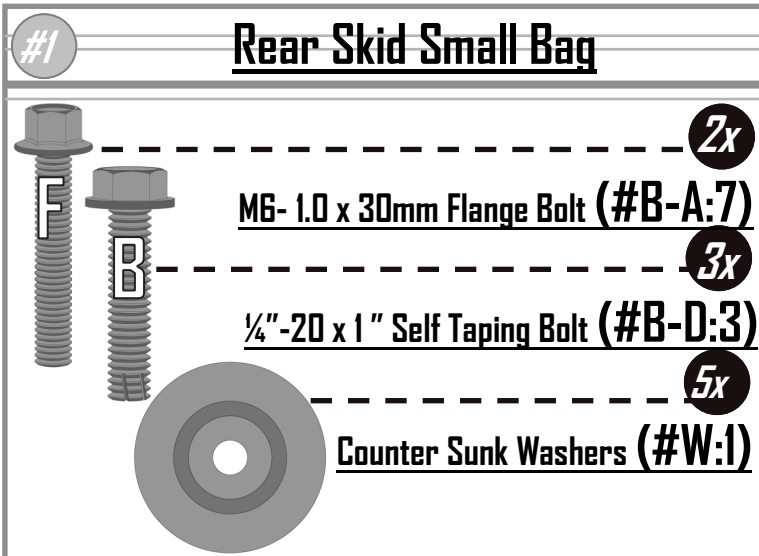

2x M6- 1.0 x 30mm Flange Bolt (#B-A:7)

3x  $\frac{1}{4}$ "-20 x 1" Self Taping Bolt (#B-D:3)

5x Counter Sunk Washers (#W:1)

**#1** Side Skid small bag:

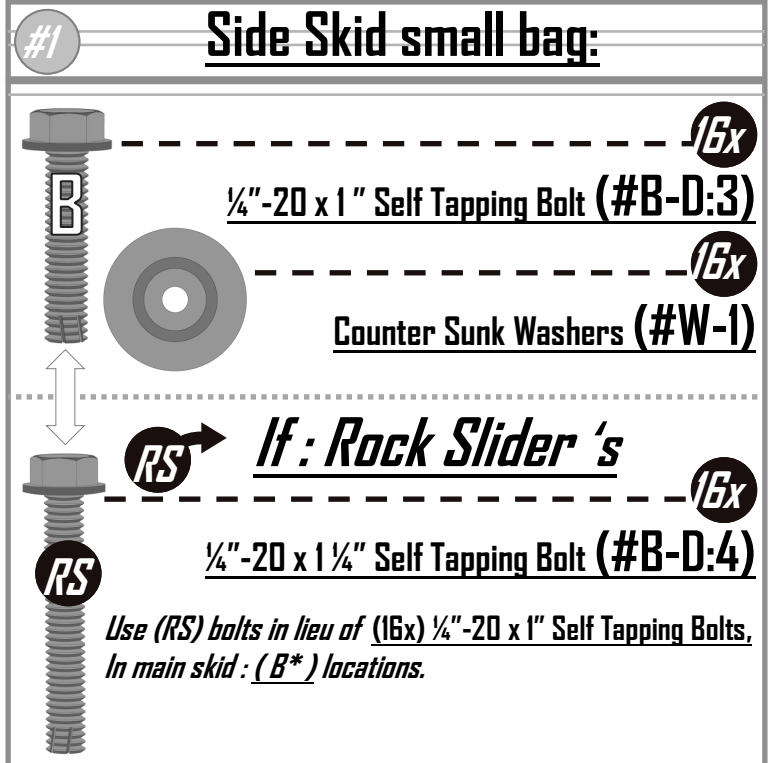

16x  $\frac{1}{4}$ "-20 x 1" Self Tapping Bolt (#B-D:3)

16x Counter Sunk Washers (#W:1)

**RS** If: Rock Slider 's

16x  $\frac{1}{4}$ "-20 x  $1\frac{1}{4}$ " Self Tapping Bolt (#B-D:4)

Use (RS) bolts in lieu of (16x)  $\frac{1}{4}$ "-20 x 1" Self Tapping Bolts, In main skid: (B\*) locations.

## Brackets & Clamps

(in separate packaging or bolted to skid for shipping)

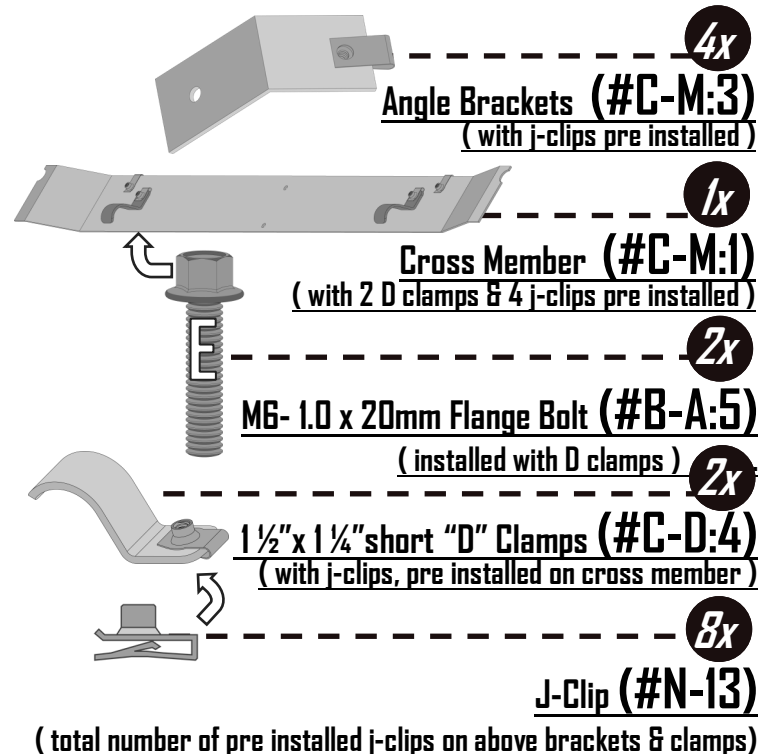

4x Angle Brackets (#C-M:3)  
(with j-clips pre installed)

1x Cross Member (#C-M:1)  
(with 2 D clamps & 4 j-clips pre installed)

2x M6- 1.0 x 20mm Flange Bolt (#B-A:5)  
(installed with D clamps)

2x  $1\frac{1}{2}$ " x  $1\frac{1}{4}$ " short "D" Clamps (#C-D:4)  
(with j-clips, pre installed on cross member)

8x J-Clip (#N-13)  
(total number of pre installed j-clips on above brackets & clamps)