

Contact Us: FACTORY UTV LLC

9237 Beatty Drive Sacramento, CA 95826

Phone : (916) 383-2730

E-mail : info@factoryutv.net

Go online: www.Factoryutv.net



U.H.M.W. Skid Plate / Under Armor Package

Ultra. High. Molecular. Weight. polyethylene all terrain skid plate / under armor kit for UTV's

Installation Guide (Ultimate)

Polaris

RZR 4 900 (2014 - 2021+)

Fits: RZR 4 900 EPS - 4 900 S - 4 1000 S



Factory UTV Polaris RZR 4 900 (2014 - 2021+) Instructions

Remove stock skid plate and re-use stock hardware as needed in all (A) locations.

May need the use of a car jack and clamps to aid during install, Skid's will form to vehicle during installation.

- #1** **Chassis Frame Mounts:**
Install (4x) angle brackets using 4x of the stock self tapping bolts, thread in to chassis frame (A) locations.
Install Cross member : Use (1x) stock bolt in center (A) location, (2x) "D" clamps W/ (2x) M6- 1.0 x 20mm Flange Bolt in (E) locations

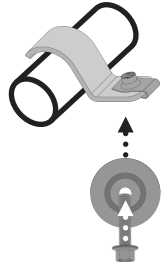
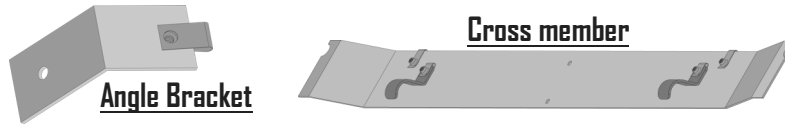

- #2_{a+b}** **Main and Mid Skid Plates :**
Install mid skid 2_(b) before main skid 2_(a), align edges. Use: (8x) Stock Bolts in : (A) locations.
Install: (4x) M6-1.0 x 25mm Flange Bolts with "D" Clamps in Main Skid 2_(a) : (D) locations.
Install: (6x) M6-1.0 x 20mm Flange Bolts in Main and Mid Skid : (E) locations. (in angle bracket locations)
Defer side (B*) locations Until Step (#5)

- #3** **Rear Skid Plate :**
Align edge with mid skid plate 2_(b)
Install: (2x) M6- 1.0 x 30mm Flange Bolts in Rear Skid : (F) locations.
(See Drilling Instructions Below) Align, mark, drill, and
Install: (3x) 1/4" -20 x 1" Self Tapping Bolts, in Rear Skid : (B) locations.



- #4** **Front Diff. Skid Plate :**
(See Drilling Instructions Below) Align edge with Main Skid 2_(a).
Mark, drill and install: (4x) 1/4" -20 x 3/4" Self Tapping Bolts in Front Diff. Skid : (C) locations.



- #5** **Side Mounts (B):**
(See Drilling Instructions Below)
Align, mark, drill, and Install: (16x) 1/4" -20 x 1" Self Tapping Bolts in Main Skid : (B) locations.

- RS** **If Rock Sliders (B*) :**
Place Rock sliders in-between skid and chassis frame. Using the same skid mounting locations,
install: (16x) 1/4" -20 x 1 1/4" Self Tapping Bolts, "RS" bolts, In main and mid skid : (B*) locations.
(In lieu of (16) (1/4" -20 x 1" Self Tapping Bolts) side bolts.)



*** Drilling Instructions : ***

Use a : #N $\text{\textcircled{7}}$ (13/64th) drill bit,

(one size above the commonly available 3/16th bit) Recommended 1/4" - 20 Tap *(Optional)

To drill and thread self tapping bolts in to chassis frame.

Finger Thread All Bolts Prior To Fastening Securely With Power Tools.

We strongly recommend the use of a "Thread Locking Compound" when installing any mounting hardware.

(When installation is complete , ensure all bolts are fastened securely.)

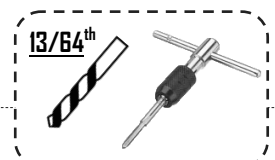

(1/4" -20) Tap
Recommended for
*drilled locations

Polaris RZR 4 900 (2014 - 2021+) Instructions

(RZR 4 900 EPS - 4 900 S - 4 1000 S)

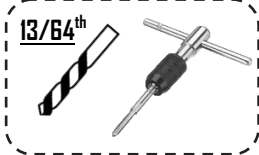

13/64th

(1/4"-20) Tap
Recommended for
*drilled locations



* (Align edges)



"D" Clamp



D

Remove stock skid plate.
Re-use stock hardware.
Install all mounting brackets first.
Tighten skid bolts loosely for install
adjustments as needed.
fasten all bolts securely
when complete.

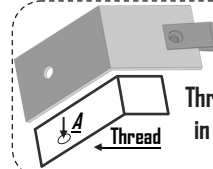

Angle Bracket

Thread stock self tapping "A" bolts
in to un-threaded holes in frame.

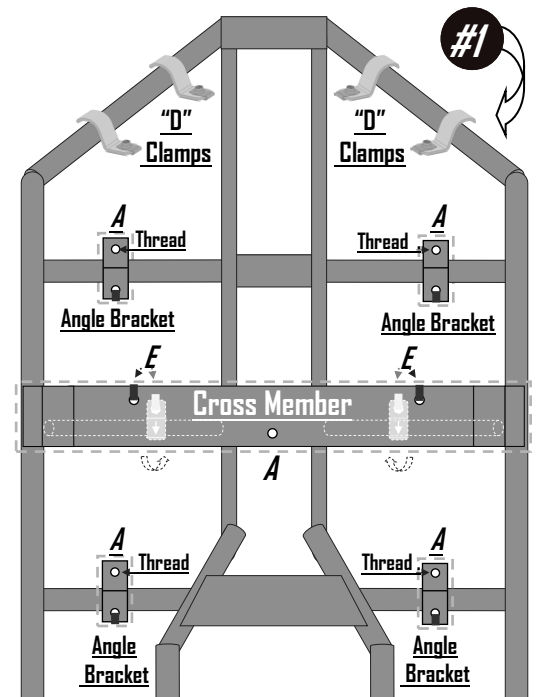
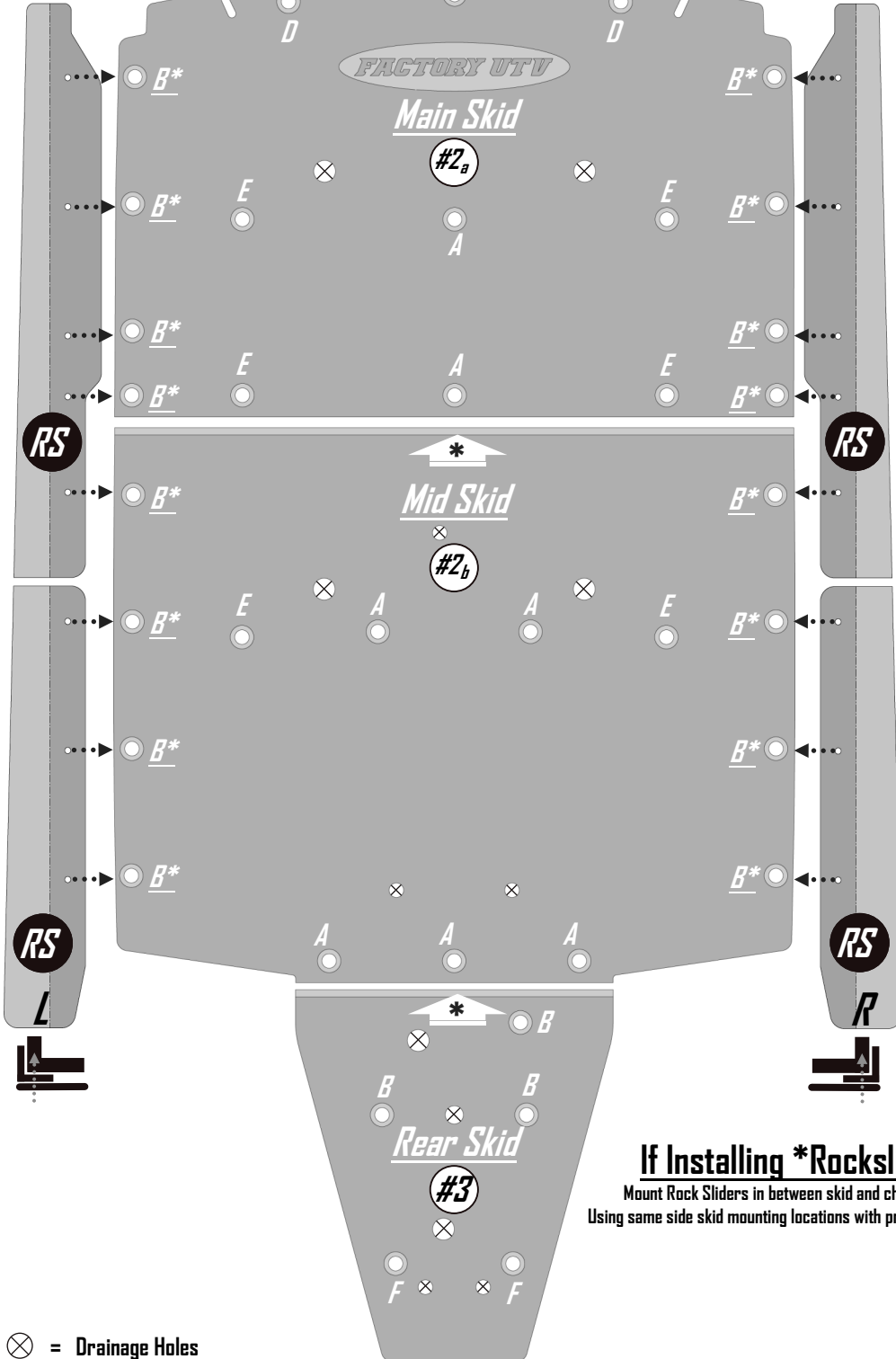

Bolt D clamps on to Cross Member,
flip and mount on to chassis frame

"_" Underscore locations
require drilling.

"*" Star locations can use RS bolts

If Installing *Rocksliders

Mount Rock Sliders in between skid and chassis frame.
Using same side skid mounting locations with provide (RS) bolts.



Use of clamps and/or
Floor jack may aid in installation.

⊗ = Drainage Holes
Do Not Use For Mounting

Factory UTV Polaris RZR 4 900 (2014 - 2021+) Hardware

(RZR 4 900 EPS - 4 900 S - 4 1000 S)

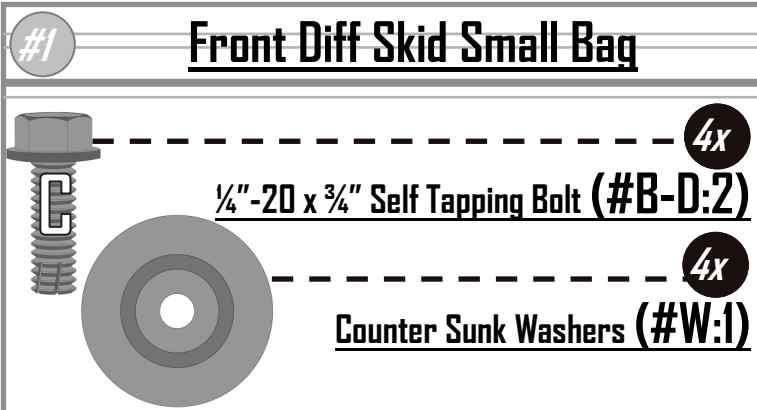

#1 Front Diff Skid Small Bag

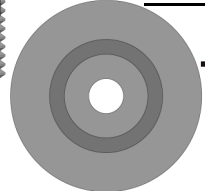

-  4x $\frac{1}{4}$ "-20 x $\frac{3}{4}$ " Self Tapping Bolt (#B-D:2)
-  4x Counter Sunk Washers (#W:1)

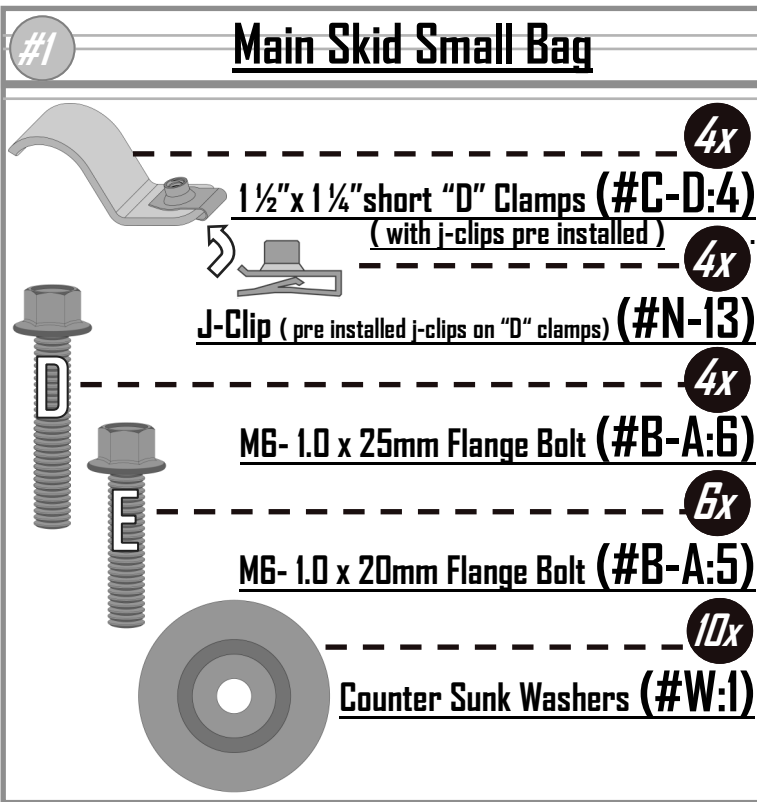

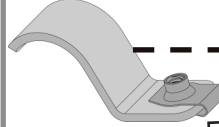
#1 Main Skid Small Bag

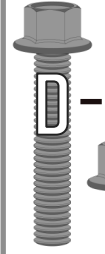
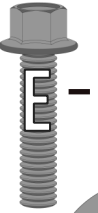
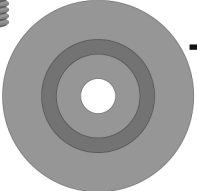

-  4x $1\frac{1}{2}$ " x $1\frac{1}{4}$ " short "D" Clamps (#C-D:4) (with j-clips pre installed)
-  4x J-Clip (pre installed j-clips on "D" clamps) (#N-13)
-  4x MG- 1.0 x 25mm Flange Bolt (#B-A:6)
-  6x MG- 1.0 x 20mm Flange Bolt (#B-A:5)
-  10x Counter Sunk Washers (#W:1)

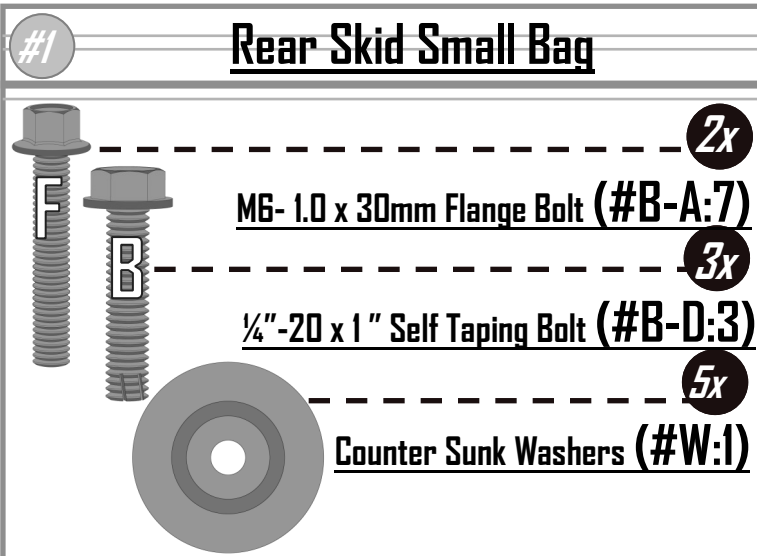

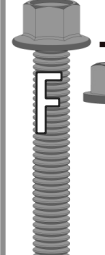
#1 Rear Skid Small Bag

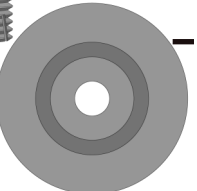

-  2x MG- 1.0 x 30mm Flange Bolt (#B-A:7)
-  3x $\frac{1}{4}$ "-20 x 1" Self Tapping Bolt (#B-D:3)
-  5x Counter Sunk Washers (#W:1)

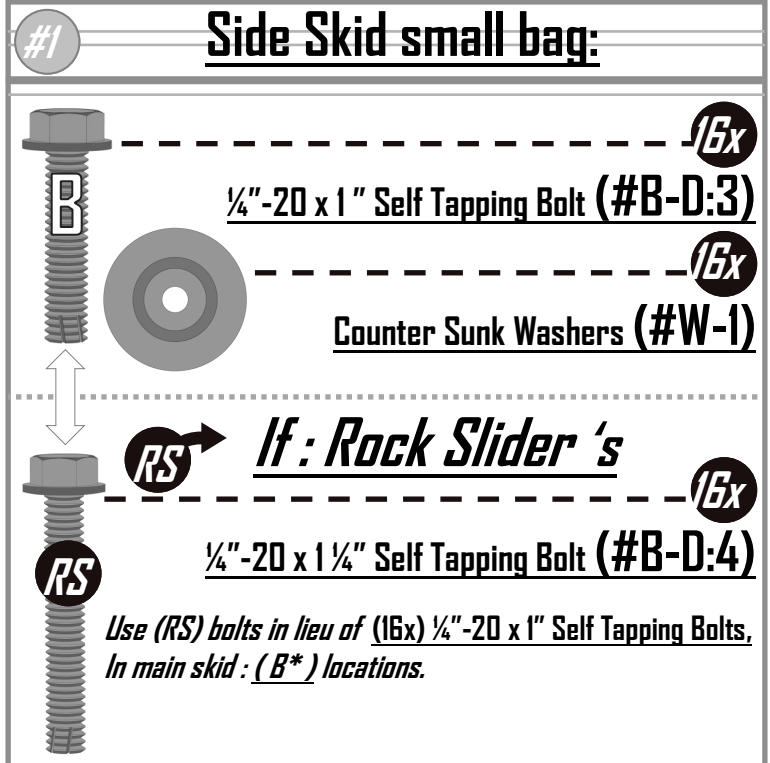
#1 Side Skid small bag:

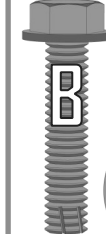



-  16x $\frac{1}{4}$ "-20 x 1" Self Tapping Bolt (#B-D:3)
-  16x Counter Sunk Washers (#W:1)
-  16x *If: Rock Slider's* $\frac{1}{4}$ "-20 x $1\frac{1}{4}$ " Self Tapping Bolt (#B-D:4)

Use (RS) bolts in lieu of (16x) $\frac{1}{4}$ "-20 x 1" Self Tapping Bolts, In main skid: (B) locations.*

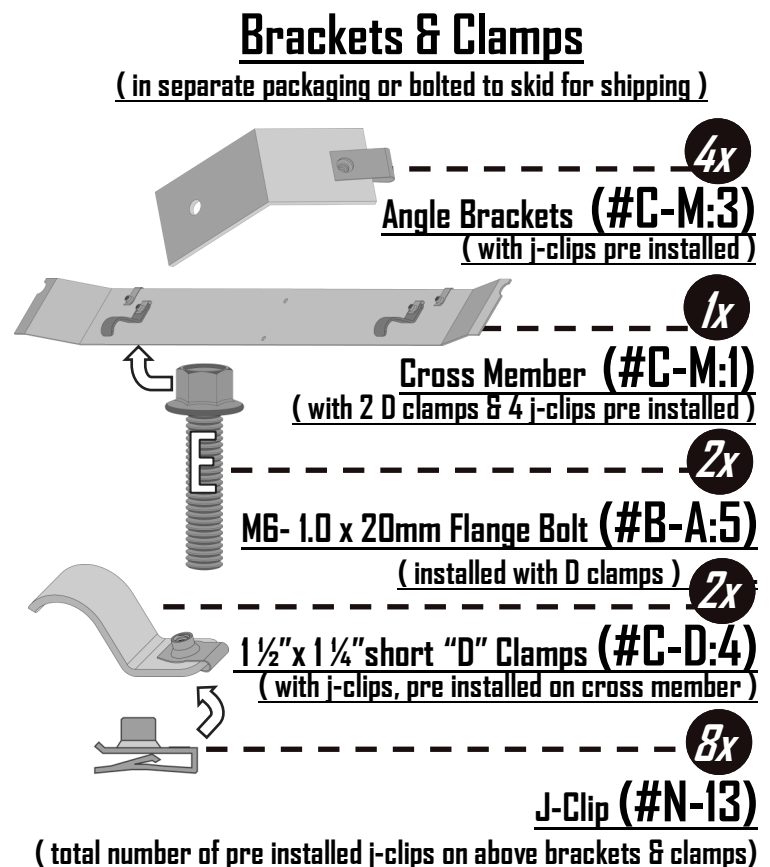
Brackets & Clamps
(in separate packaging or bolted to skid for shipping)

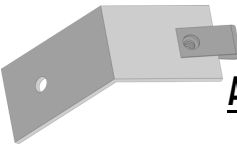

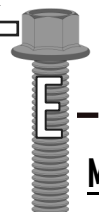
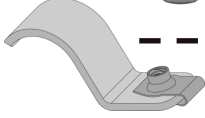
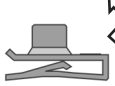

-  4x Angle Brackets (#C-M:3) (with j-clips pre installed)
-  1x Cross Member (#C-M:1) (with 2 D clamps & 4 j-clips pre installed)
-  2x MG- 1.0 x 20mm Flange Bolt (#B-A:5) (installed with D clamps)
-  2x $1\frac{1}{2}$ " x $1\frac{1}{4}$ " short "D" Clamps (#C-D:4) (with j-clips, pre installed on cross member)
-  8x J-Clip (#N-13)

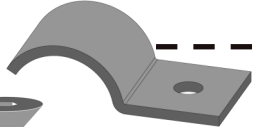

(total number of pre installed j-clips on above brackets & clamps)

Factory UTV Polaris RZR 4 900 (2014 - 2021+) UHMW A-Arm Guard hardware
(RZR 4 900 EPS - 4 900 S - 4 1000 S)

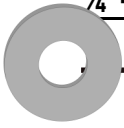
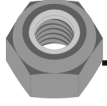
Front A-Arm: Large bag

- 
4x
1"x 1" "D" Clamps (#C-D:2)
- 
4x
1/4"-20 x 1" Counter Sunk Bolts (#B-C:1)
- 
4x
1/4"-20 x 1 1/2" Counter Sunk Bolts (#B-C:3)
- 
8x
1/4" Gold Washers (#W-3.0)
- 
8x
1/4"-20 Ny-Lock Nut (#N-2)

Rear A-Arm: Large bag

- 
6x
1/4"-20 x 2 1/2" Counter Sunk Bolts (#B-C:6)
- 
6x
1/4" Gold Washers (#W-3.0)
- 
6x
1/4"-20 Ny-Lock Nut (#N-2)

Factory UTV Polaris RZR 4 900 (2014 - 2021+) UHMW A-Arm Guard Instructions

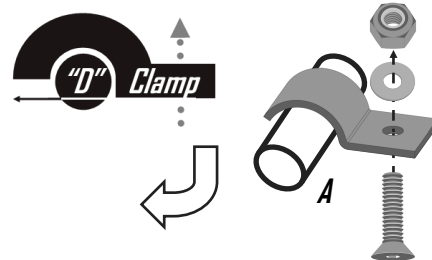
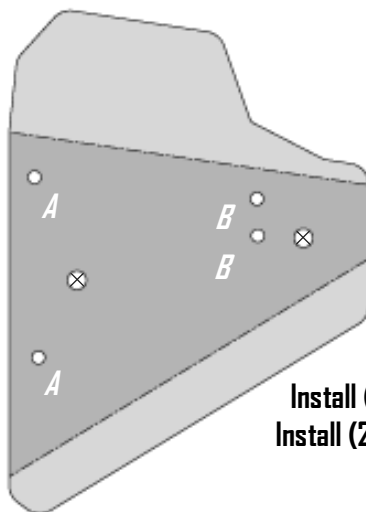
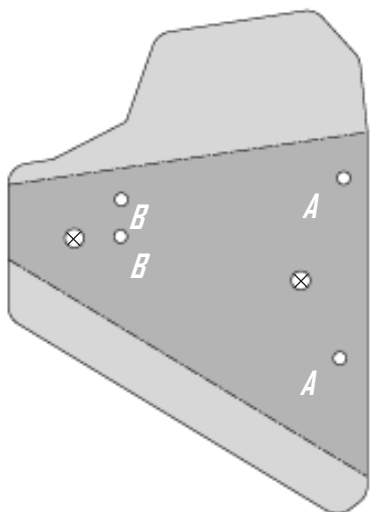

Front A-Arm Guards:

Holding "D" clamps over a-arm tubing,
Install (2x) $\frac{1}{4}$ "-20 x 1" Counter Sunk Bolts in (A) locations,
Install (2x) $\frac{1}{4}$ "-20 x 1 $\frac{1}{2}$ " Counter Sunk Bolts in (B) locations,
all with washers and Nylock nuts.

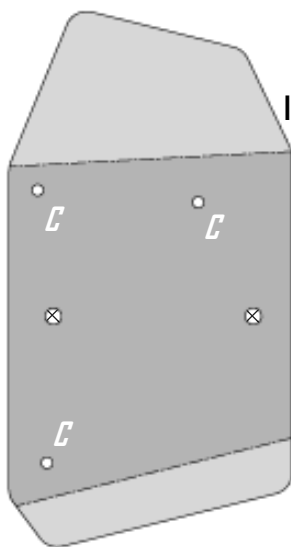
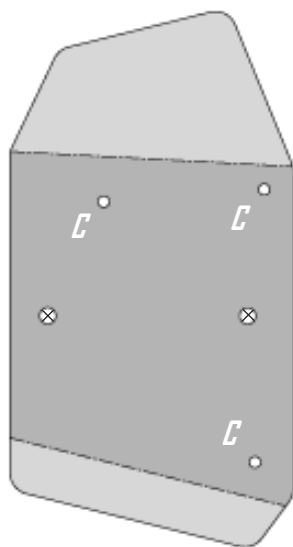





Rear A-Arm Guard:

Install (3x) $\frac{1}{4}$ "-20 x 2 $\frac{1}{2}$ " Counter Sunk Bolts in (C) locations
all with washers and Nylock nuts.

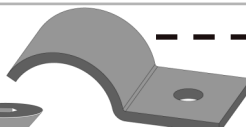

Ensure all bolts are fasten securely before use
Do Not Over Tighten Bolts.

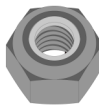

Front A-Arm: Large bag

-  **4x**
1" x 1" "D" Clamps (#C-D:2)
-  **4x**
 $\frac{1}{4}$ "-20 x 1" Counter Sunk Bolts (#B-C:1)
-  **4x**
 $\frac{1}{4}$ "-20 x 1 $\frac{1}{2}$ " Counter Sunk Bolts (#B-C:3)
-  **8x**
 $\frac{1}{4}$ " Gold Washers (#W-3.0)
-  **8x**
 $\frac{1}{4}$ "-20 Ny-Lock Nut (#N-2)

Rear A-Arm: Large bag

-  **6x**
 $\frac{1}{4}$ "-20 x 2 $\frac{1}{2}$ " Counter Sunk Bolts (#B-C:6)
-  **6x**
 $\frac{1}{4}$ " Gold Washers (#W-3.0)
-  **6x**
 $\frac{1}{4}$ "-20 Ny-Lock Nut (#N-2)

⊗ = Drainage Holes
Do Not Use For Mounting