

**Contact Us: *FACTORY UTV LLC***

9237 Beatty Drive Sacramento, CA 95826

Phone : (916) 383-2730

E-mail : [info@factoryutv.net](mailto:info@factoryutv.net)

Go online: [www.Factoryutv.net](http://www.Factoryutv.net)

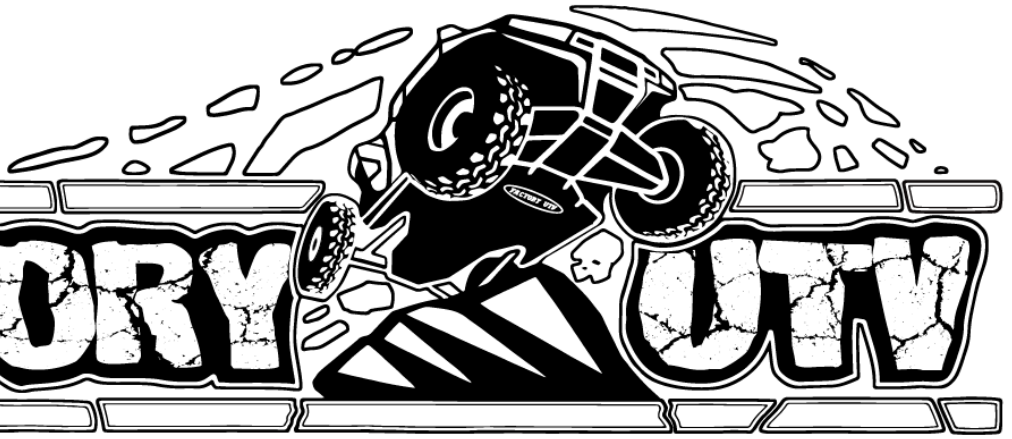

## **U.H.M.W. Skid Plate / Under Armor package**

*Ultra. High. Molecular. Weight. polyethylene all terrain skid plate / under armor kit for UTV's*

# ***Yamaha Wolverine R Spec***

***(fits year models 2016-2018)***

## **Installation guide**



# Yamaha

## Wolverine (R Spec) 2016

# Skid Plate Mounting Hardware Kit

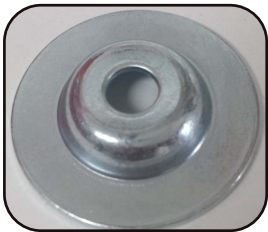
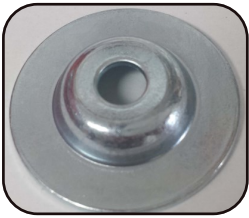
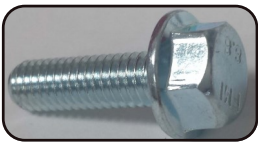

### Main Skid Hardware

J - Clamp Mounts (Total Count) **32**

M6 - 1.0 x 20mm Flange Bolts **12**

Counter Sunk Washers **12**

### Front Differential Skid Hardware

1/4" - 20 x 1" Flange Bolt **6**

M6 - 1.0 x 20mm Flange Bolts **2**

Counter Sunk Washers **8**

UHMW 3/8 spacers **2**

### Rear Skid Hardware

M6 - 1.0 x 20mm Flange Bolts **4**

Counter Sunk Washers **4**

### Side Skid Hardware (On each side) (16 total)

M6 - 1.0 x 20mm Flange Bolts **8**

Counter Sunk Washers **8**

### Side Skid Hardware (On each side) (16 total)

M6 - 1.0 x 20mm Flange Bolts **8**

Counter Sunk Washers **8**

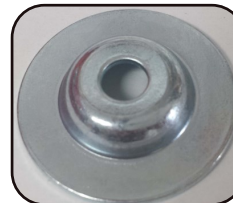
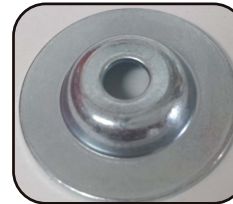
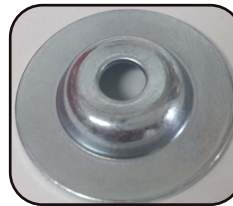
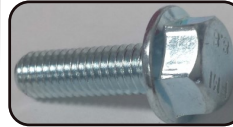

# Yamaha Wolverine R Spec 2016-19

**Note:**  
**J-Clip**  
**Placement For**  
**Further Steps**

**Remove all**  
**stock skid**  
**plates**

**#1**

**Install: (32x) J-clips,**  
**With threaded tip pointing**  
**up towards the vehicle.**  
**J-clips are difficult to**  
**remove once installed.**



**These J-Clips**  
**provide secure and**  
**simple mounting**  
**points for the UHMW**  
**skid plate.**  
**Ensure they are in-**  
**stalled in the correct**  
**direction.**

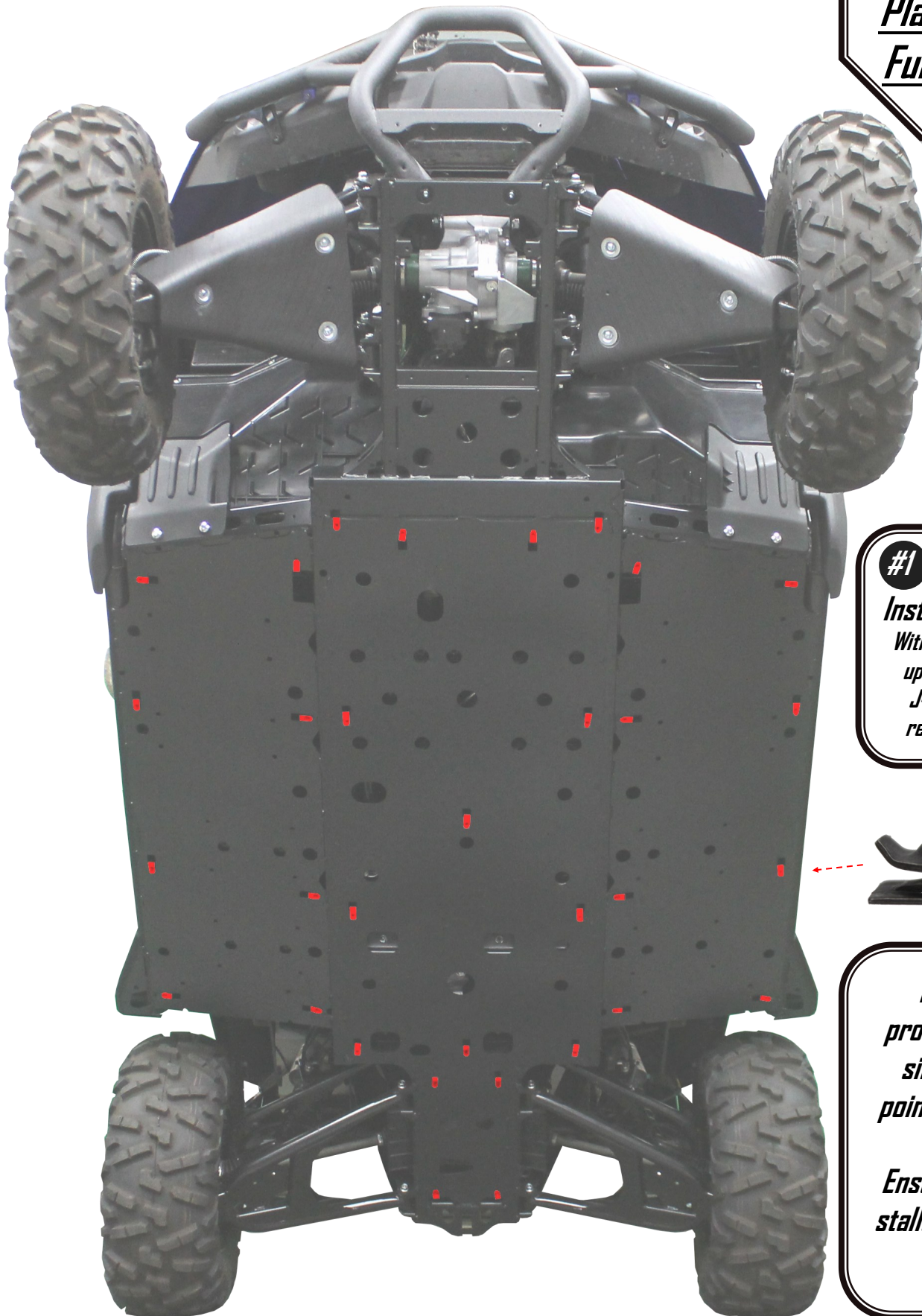

# Yamaha Wolverine R Spec Main Skid

**Note:**  
Use a nut driver or  
finger thread the bolts  
before Fastening,  
J-clamps can "strip out"  
if installed incorrectly.

*we recommend using  
A thread locker  
compound.*

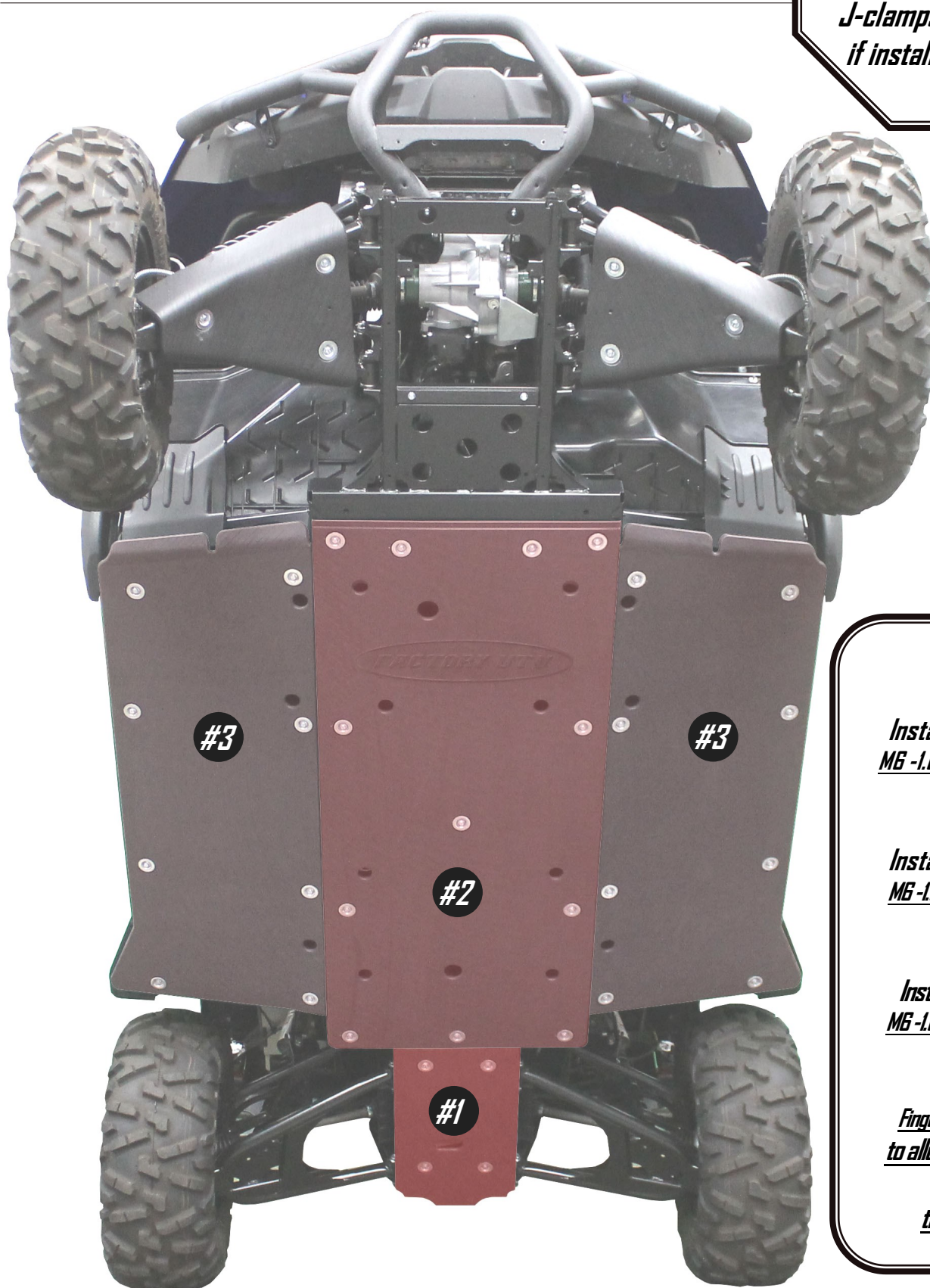

- #1**  
***Install rear skid, use:  
MG -1.0 x 20mm Flange Bolts***
- #2**  
***Install Main skid, use:  
MG -1.0 x 20mm Flange Bolts***
- #3**  
***Install side skid's, use:  
MG -1.0 x 20mm Flange Bolts***
- #4**  
***Finger tighten all bolts,  
to allow for adjustments,  
When in place,  
tighten securely.***

# Yamaha

## Wolverine (R Spec)

## Front Diff.

**Note:**  
Figure #A

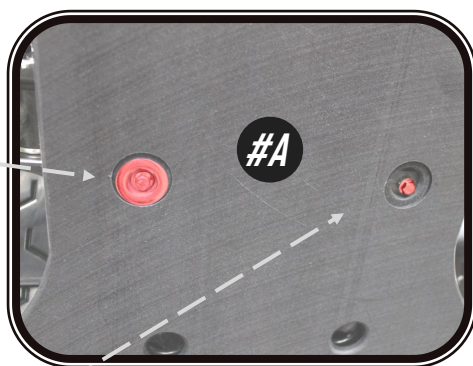
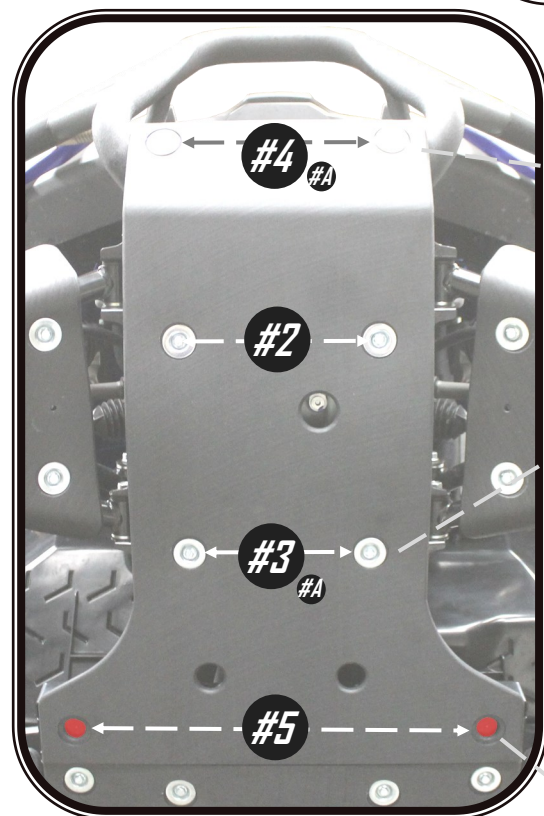
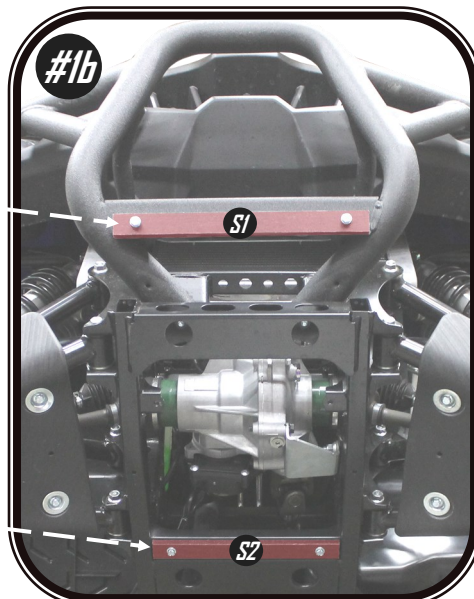
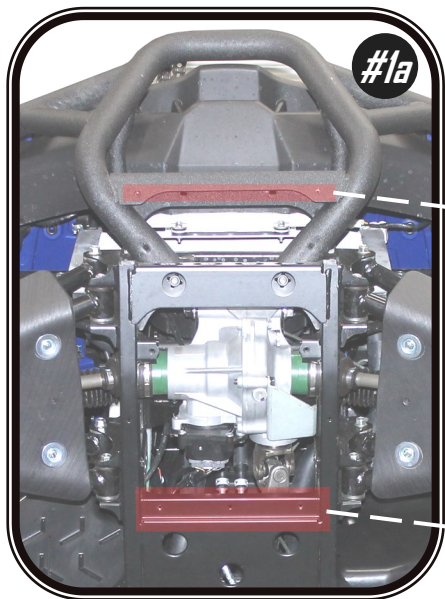

**#A** 2 step  
For the mounting holes under the UHMW spacers, back out one bolt at a time, ( in 2 steps ) so it doesn't slip out of place  
Re-install bolt with washer (as shown in fig #A)



**#1**  
Install : 2x UHMW spacers on the front differential ( S1 & S2 )  
(Finger tighten bolts )

**#2**  
Install :  
Front differential skid  
Using 2x bolts (at fig,#2)  
1/4"-20 x 1"Self Tapping Bolts

**#3**  
Install: 2x bolts next to (fig #3)  
{ Referencing fig. #A 2step }  
1/4"-20 x 1"Self Tapping Bolts

**#4**  
Install : 2x front bolts  
(M6 -1.0 x 20mm Flange Bolts)  
{ Referencing fig. #A 2step }

**#5**  
Make a score or mark  
In the center of the holes in (fig #5) Drill a 13/64th inch hole, tap thread if desired  
Use 1/4"- 20 tap & Install 2x 1/4"-20 x 1"Self Tapping Bolts

**#6**  
Tighten All Bolts Securely

# Yamaha

## Wolverine (R Spec) A-Arm Guard

**Note:**  
Direction of  
A-Arms and  
Spacers

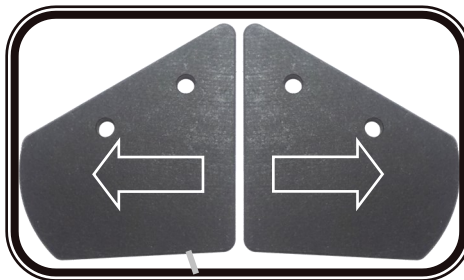

**Rear Hardware**  
 (4x) 1" x 1 1/4" "D" Clamps  
 (4x) 1/4" x 20" x 1"  
Counter sunk bolts  
 (4x) 1/4" x 20" x 1 1/2"  
Counter sunk bolts  
 (8x) 1/4" x 20" Ny-Lock Nuts  
 (8x) 1/4" Gold Washers  
 (2x) UHMW Spacers

**Front Hardware**  
 (6x) Counter Sunk  
 Washers  
 (6x) M6- 1.0 x 20mm  
Flange bolts  
 (2x) M6-1.0 Top Lock Nuts

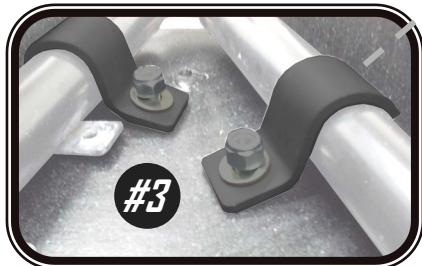
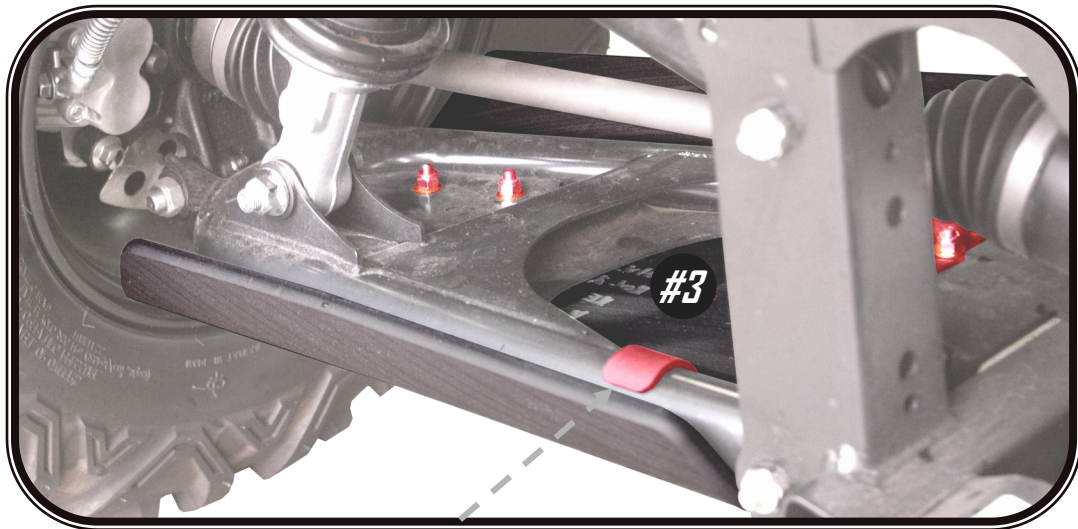
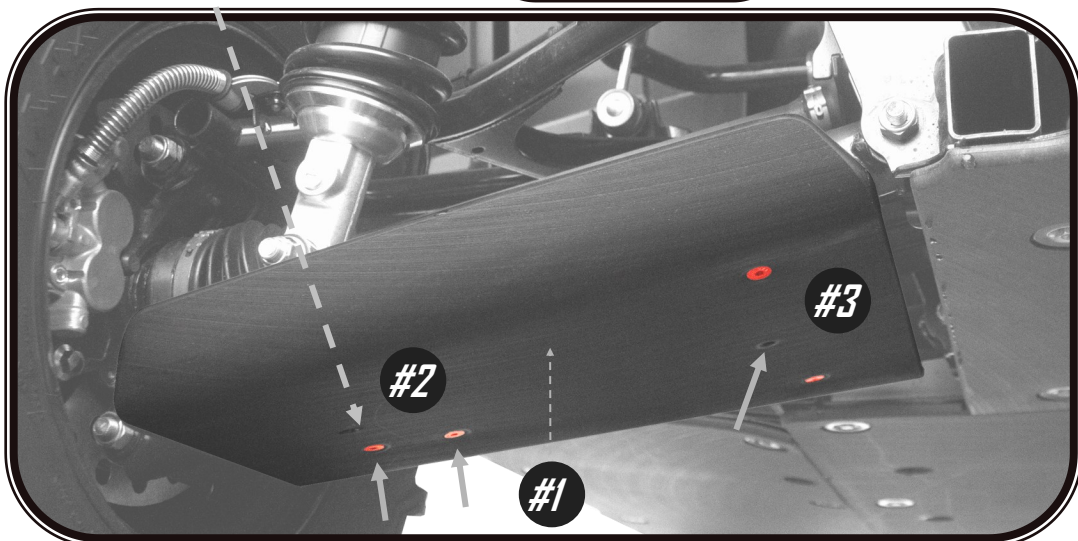

*We recommend the use of a thread  
 locker compound for this application*

### Rear A-Arm Guards

**#1** Install : A-Arm guard  
 Note direction of  
 Spacers and hold in place

**#2** Align and install 2x  
 1/4" -20" x 1 1/2"  
 Counter sunk bolts  
 With 1/4" Gold Washers and  
 1/4" -20" Ny-Lock Nuts  
 finger tighten bolts for adjustment

**#3** Install :  
 1" x 1 1/4" "D" Clamps with  
 1/4" - 20" x 1"  
 Counter sunk bolts  
 With 1/4" Gold Washers  
 1/4" - 20" Ny-Lock Nuts  
 Adjust A-Arm guard to best fit  
 Tighten all bolts securely

### Front A-Arm Guards

**Install : Front A-Arm Guards**  
 (using similar method)  
**#4** Use: M6 - 1.0 x 20mm  
 Flange Bolts  
 With Counter Sunk Washers  
 and M6 - 1.0 Top Lock Nuts  
 Finger tighten bolts  
 Adjusting to best fit  
 Tighten all bolts securely