

**Contact Us: *FACTORY UTV LLC***

9237 Beatty Drive Sacramento, CA 95826

Phone : (916) 383-2730

E-mail : [info@factoryutv.net](mailto:info@factoryutv.net)

Go online: [www.Factoryutv.net](http://www.Factoryutv.net)



## **U.H.M.W. Skid Plate / Under Armor Package**

*Ultra. High. Molecular. Weight. polyethylene all terrain skid plate / under armor kit for UTV's*

### **Installation Guide (Skid Package)**

***Textron Off Road***

***Wildcat XX (2018 - 2021+)***



# Textron Off Road Wildcat XX (2018 - 2021+) Instructions

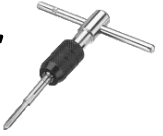

## Remove stock main and rear skid plates.

Fasten bolts loosely to allow for slight adjustments before fastening securely.

(1/4"-20) Tap  
Required

#1

## Main Skid Plate :

Install: (4x) M6- 1.0 x 20mm Flange Bolts in Main Skid Side: (A) Locations,

Install: (15x) 1/4"-20 x 3/4" Self Tapping Bolts in Main Skid: (B) Locations.

(4x) B\* locations require drilling \*(See Drilling Instructions Below)\*

Reserve the final (3x) (B) locations at bottom of Main Skid, for Rear Skid install.

RS

## If Rock Sliders :

Use: (4x) 1/4"-20 x 1 1/4" Self Tapping Bolts, "RS-B" bolts In Main Skid Side: (B) Locations.

Use: (4x) M6- 1.0 x 30mm Flange Bolts "RS-A" bolts In Main Skid Side: (A) Locations.

In lieu of main skid (4x) 1/4"-20 x 3/4" Self Tapping Bolts and (4x) M6- 1.0 x 20mm Flange Bolts

Place Rock Sliders In-Between Skid And Chassis Frame.

#2

## Rear Skid Plate :

\*(See Drilling Instructions Below)\* Align edge with Main Skid plate.

Install: (3x) 1/4"-20 x 3/4" Self Tapping Bolts in remaining Main Skid: (B) Locations.

Install: (6x) 1/4"-20 x 3/4" Self Tapping Bolts in Rear Skid: (B) Locations.

(2x) B\* locations require drilling \*(See Drilling Instructions Below)\*

Install: (2x) M6- 1.0 x 20mm Flange Bolts in Rear Skid : (A) Locations

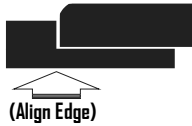

(Align Edge)

#3

## Front Diff. Skid Plate :

\*(See Drilling Instructions Below)\* Align edge with Main Skid.

Mark, drill, tap and install: (6x) 1/4"-20 x 1/2" Flange Bolts in Front Diff. Skid: (C) Locations.

Thick Plating On Front Diff Locations, Drill and tap thread using: 1/4"- 20 Tap in Front Diff. Skid: (C) Locations.



\*(Align Edge)

A:1

## A-Arm Guards (A:1)

Install: (5x) 1"x 1 3/8 " "D" Clamps over A-Arm tubing, with

(5x) 1/4"-20 x 1 1/4" Counter Sunk Bolts, (5x) 1/4" Gold Washers, (5x) 1/4"-20 Ny-Lock Nuts For Each A-Arm in: (A:1) locations.

Install bolts loosely during install for adjustment, Fasten bolt head flush and securely when complete, do not over tighten.



Do not over tighten,  
Fasten bolts until flush

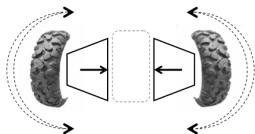

\* Ensure Clearance For Turn Radius & Vertical Travel

## \* Drilling Instructions : \*

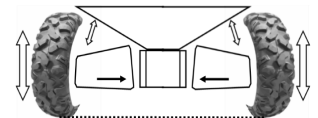

Use a : #No7 (13/64<sup>th</sup>) drill bit,

(one size above the commonly available 3/16<sup>th</sup> bit) Required 1/4"- 20 Tap for (C) locations

To drill and thread self tapping bolts in to chassis frame.

Finger Thread All Bolts Prior To Fastening Securely With Power Tools.

We strongly recommend the use of a "Thread Locking Compound" when installing any mounting hardware.

(When installation is complete , ensure all bolts are fastened securely.)

# Textron Off Road Wildcat XX (2018 - 2021+)

Remove stock skid plate. Fasten bolts loosely to allow for adjustments, fasten all bolts securely when complete. (1/4"-20) Tap Required for C\* locations, But recommended on all \*drilled locations for ease of install.

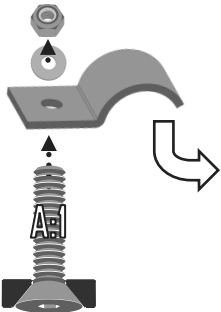

Do not over tighten counter sunk bolts, Fasten bolts until flush

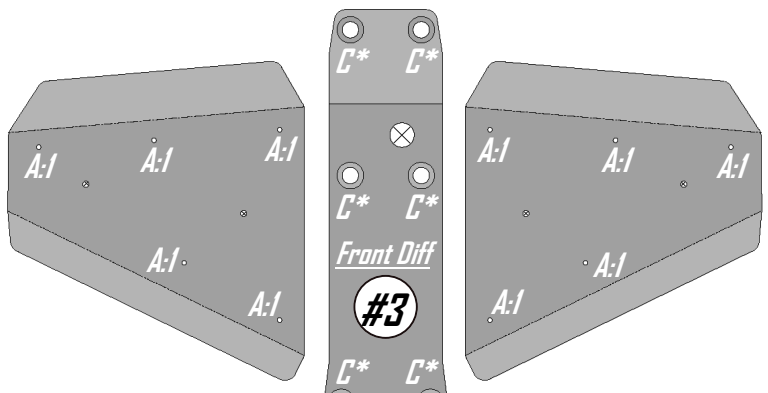

(1/4"-20) Tap

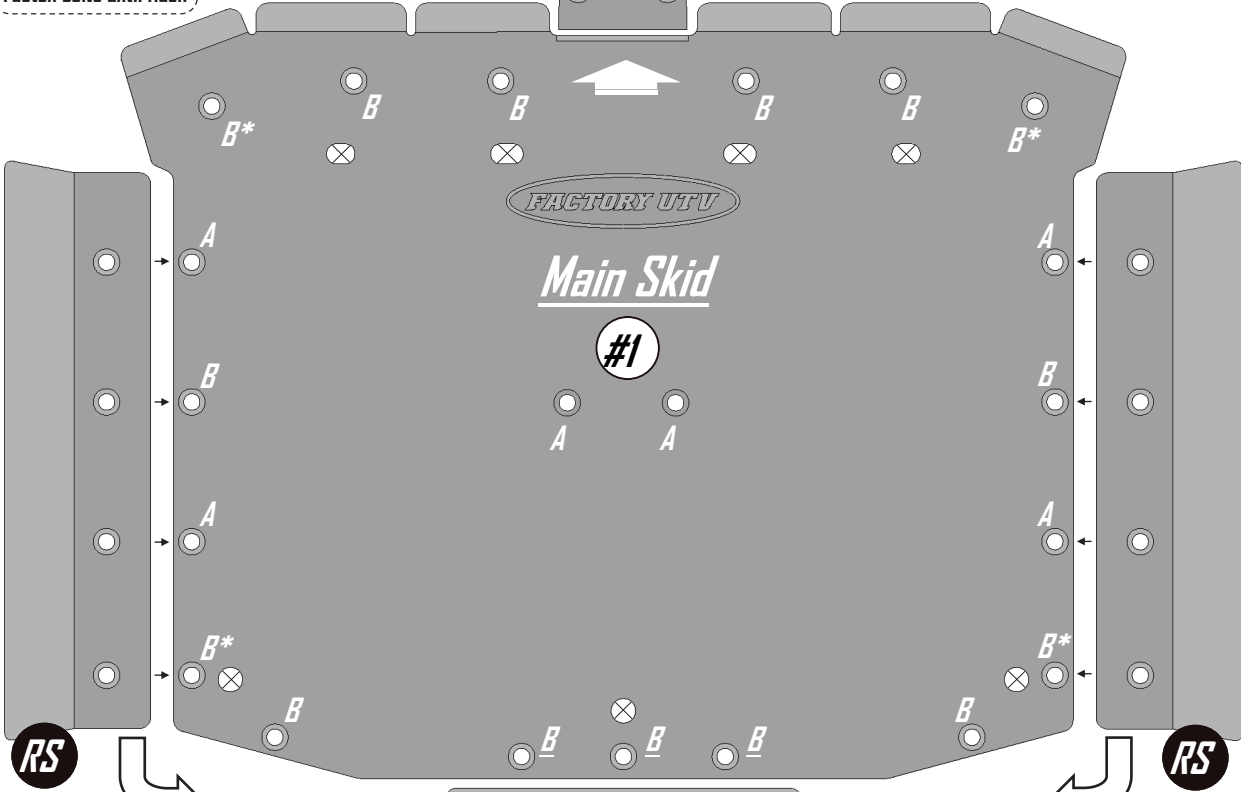

(Align Edge)

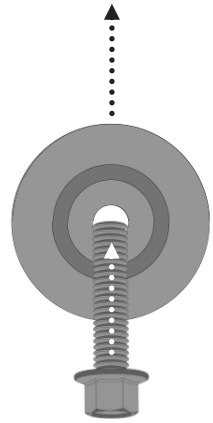

RS

RS



L

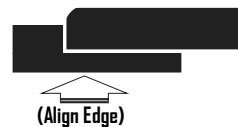

(Align Edge)



R

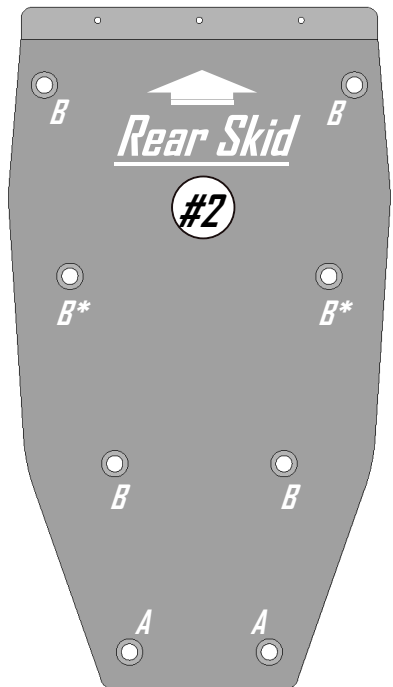

**\*** : Locations Require Drilling And/or 1/4"-20 Tap

⊗ = Drainage Holes Do Not Use For Mounting

# Textron Off Road Wildcat XX (2018 - 2021+) Hardware kit

**#1 Main Skid Small Bag**

 **15x**  
 1/4"-20 x 3/4" Self Tapping Bolt (#B-D:2)

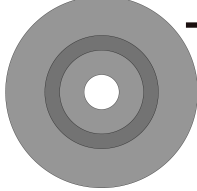
 **15x**  
 Counter Sunk Washers (#W:1)

**#3 Rear Skid Small Bag**

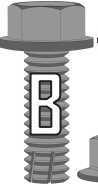
 **6x**  
 1/4"-20 x 3/4" Self Tapping Bolt (#B-D:2)

 **2x**  
 M6- 1.0 x 20mm Flange Bolt (#B-A:5)

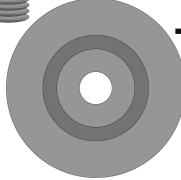
 **8x**  
 Counter Sunk Washers (#W:1)

**#2 Side Bolts Large Bag**

 **4x**  
 1/4"-20 x 3/4" Self Tapping Bolt (#B-D:2)

 **4x**  
 M6- 1.0 x 20mm Flange Bolt (#B-A:5)

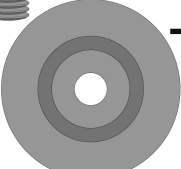
 **8x**  
 Counter Sunk Washers (#W:1)

**#4 Front Diff. Small Bag**

 **6x**  
 1/4"-20 x 1/2" Flange Bolt (#B-A:1)

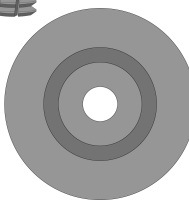
 **6x**  
 Counter Sunk Washers (#W:1)

**RS If Rock Slider: Hardware**

 **4x**  
 1/4"-20 x 1 1/4" Self Tapping Bolt (#B-D:4)  
 (In Lieu Of 4x "(B-D:2)" Bolts For Side Mount B Locations)

 **4x**  
 M6- 1.0 x 30mm Flange Bolt (#B-A:7)  
 (In Lieu Of 4x "(B-A:5)" Bolts For Side Mount A Locations)

**#5 Front A-Arms large Bag**

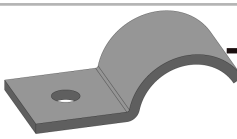
 **10x**  
 1" x 1 1/2" "D" Clamps (#C-D:7)

 **10x**  
 1/4"-20 x 1" Counter Sunk Bolts (#B-C:2)

 **10x**  
 1/4" small Gold Washers (#W-3.0)

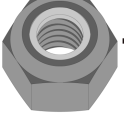
 **10x**  
 1/4"-20 x 1/2" Flange Bolt (#N-3)