

# COZONI

Assembly Instructions

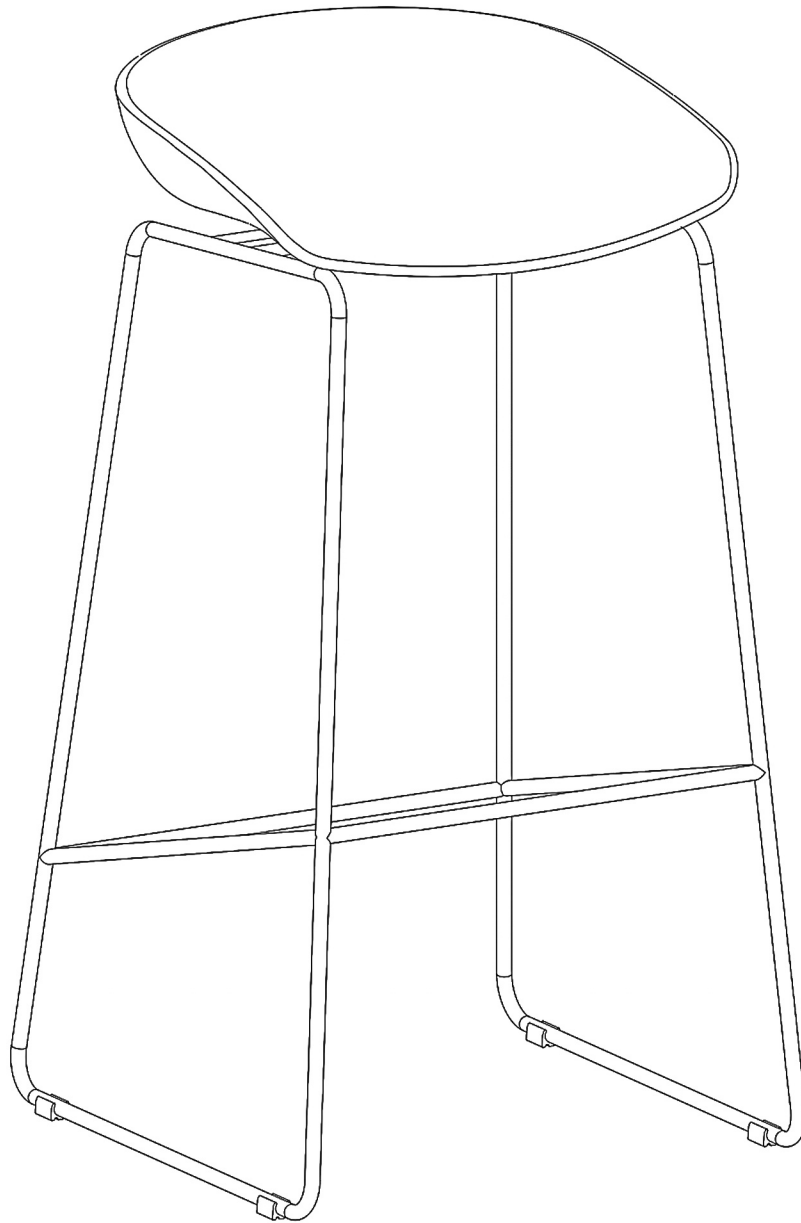

# Zane

Bar Stool

## ASSEMBLY INSTRUCTIONS

Read these instructions carefully and keep for future reference. Refer to parts inventory for guidance, and ensure you have all pieces before starting.

When assembling, place all parts on a soft, clean, and flat surface such as a carpet to prevent scratches.



15 min

TIME







# OF PEOPLE



DIFFICULTY



Hardware may loosen over time, check the bolts regularly and tighten if necessary.

PARTS INVENTORY		
ID	DESCRIPTION	QTY
A	SEAT	1
B		4
C	WASHER 	4
D	BOLT 	4
E	ALLEN KEY 	1
F	PLASTIC FEET 	4

1

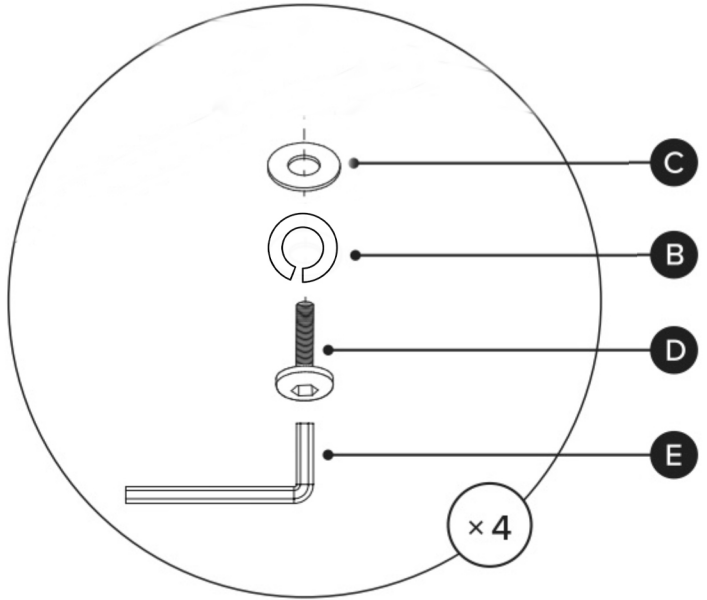
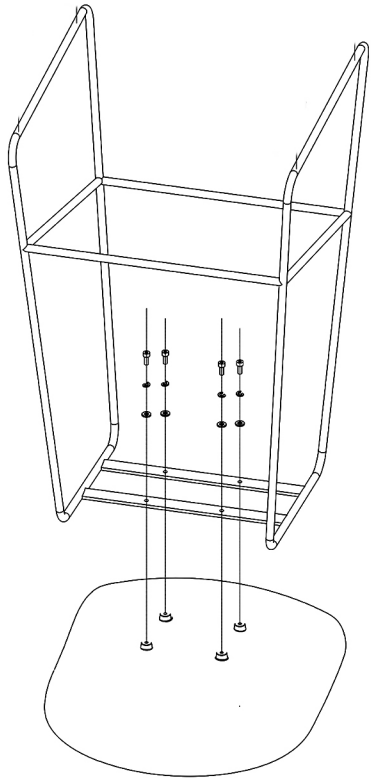

2

