

COZONI

Assembly Instructions

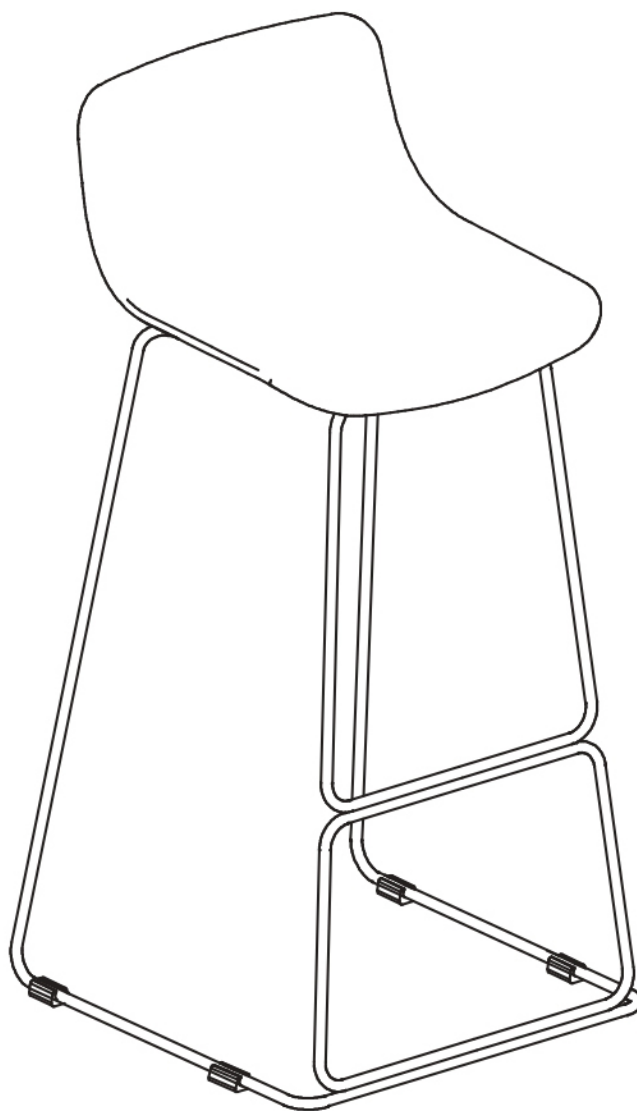

Evan

Bar Stool

ASSEMBLY INSTRUCTIONS

Read these instructions carefully and keep for future reference. Refer to parts inventory for guidance, and ensure you have all pieces before starting.

When assembling, place all parts on a soft, clean, and flat surface such as a carpet to prevent scratches.

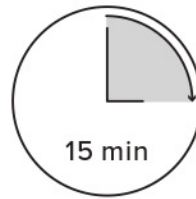

15 min

TIME







OF PEOPLE



DIFFICULTY



Hardware may loosen over time, check the bolts regularly and tighten if necessary.

| PARTS INVENTORY | | |
|-----------------|--|-----|
| ID | DESCRIPTION | QTY |
| A | SEAT | 1 |
| B | RUBBER CAP  | 4 |
| C | WASHER  | 4 |
| D | BOLT  | 4 |
| E | ALLEN KEY  | 1 |
| F | PLASTIC FEET  | 4 |

1

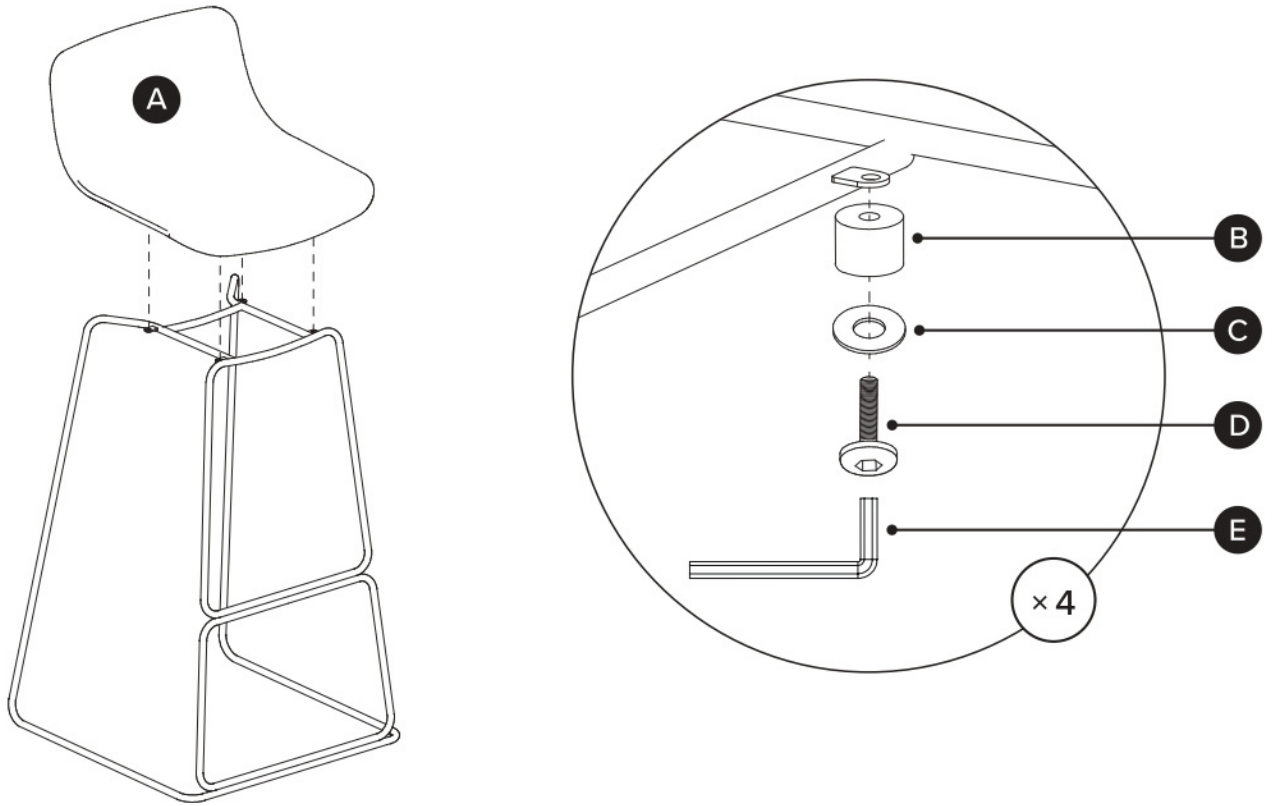

2

