



## ROMP

### Frame

Houten constructie van beuken regels, mdf panelen, etc. Voorkant is verstevigd met een metalen strip in de constructie geschroefd en verlijmd.

### Vering

Metalen no-sag veren

### Schuim

Polyether bedekt met 100 grams dacron.

## ARMEN

### Frame

Metalen gelast frame van buizen. Op het frame zijn enkele rubber strips gemonteerd om de stoffering te kunnen vastmaken.

### Schuim

Gevormd schuim HR-schuim met een soortelijk gewicht van 63kg/m<sup>3</sup>.

## ZIT- EN RUGKUSSENS

Er zijn 4 verschillende soorten uitvoeringen te verkrijgen in de OTIS en OTIS XL.

### Firm:

#### Zitkussen

De basis bestaat uit een stevig HR-schuim met een soortelijk gewicht van 40kg/m<sup>3</sup>. Daarboven is een lekker zacht HR-schuim (50kg/m<sup>3</sup>) aangebracht in spie-vorm voor een goede knieholte ondersteuning en voorkomt dat men uit de bank „glijdt“.

De bollering bovenop het kussen is gemaakt van een zacht HR-schuim (35kg/m<sup>3</sup>). Het kussen uit één stuk is overtrokken met 100 grams dacron.

#### Rugkussen

Het rugkussen bestaat uit 1 stuk gevormd HR-schuim met een soortelijk gewicht van 40kg/m<sup>3</sup>. Het kussen uit één stuk is overtrokken met 200 grams dacron.

## BODY

### Frame

Wooden construction of beech rows, MDF boards, etc. The front is reinforced with a metal strip, which was screwed and glued in place.

### Suspension

Metal no-sag springs.

### Foam

Polyurethane foam, covered with 100gr Dacron.

## ARMS

### Frame

Metal welded tubular frame. The frame features rubber strips to attach the upholstery.

### Foam

Moulded HR foam with a specific gravity of 63kg/m<sup>3</sup>.

## SEAT & BACK CUSHIONS

The OTIS and OTIS XL come in 4 different versions.

### Firm:

#### Seat cushion

The base is made of a sturdy HR foam with a specific gravity of 40kg/m<sup>3</sup>. This has been topped with a spline (specific weight 50kg/m<sup>3</sup>) of soft HR foam, fitted at the front for good knee support and to prevent “sliding” off the couch.

The rounded top of the cushion is made of a soft HR foam (35kg/m<sup>3</sup>) and covered in a single piece of 100gr Dacron.

#### Back cushion

The back cushions are made of a single piece of moulded HR foam (specific weight 40kg/m<sup>3</sup>) and covered in a single piece of 200gr Dacron.

## RUMPF

### Rahmen

Holzkonstruktion aus Buchenbalken, MDF-Paneeelen usw. Frontseite mit einem in der Konstruktion verschraubten und verleimten Metallstreifen verstärkt.

### Federung

No-Sag-Metallfedern

### Schaum

Polyether, mit 100 g/m<sup>2</sup> Dacron bedeckt.

## ARMAUFLAGEN

### Rahmen

Verschweißter Metallrahmen aus Rohren. Am Rahmen sind mehrere Gummistreifen montiert, an denen die Polsterung befestigt wird.

### Schaum

HR-Formschaum mit einer Dichte von 63 kg/m<sup>3</sup>.

## SITZ- UND RÜCKENKISSEN

Für OTIS und OTIS XL sind 4 verschiedene Ausführungen erhältlich.

### Firm:

#### Sitzkissen

Die Basis besteht aus einem festen HR-Schaum mit einer Dichte von 40 kg/m<sup>3</sup>. Darauf wird ein angenehm weicher HR-Schaum (50kg/m<sup>3</sup>) aangebracht, in Passfederform für eine gute Kniekehlenunterstützung und um zu vermeiden, dass man vom Sofa „rutscht“.

Die Ausbuchtung oben am Kissen wird aus einem weichen HR-Schaum hergestellt (35kg/m<sup>3</sup>). Das Kissen aus einem Stück wird mit 100 g/m<sup>2</sup> Dacron überzogen.

#### Rückenkissen

Das Rückenkissen besteht aus einem Stück HR-Formschaum mit einer Dichte von 40 kg/m<sup>3</sup>. Das Kissen aus einem Stück wird mit 200 g/m<sup>2</sup> Dacron überzogen.

**Medium:**

**Zitkussen**

De basis bestaat uit een comfortabel HR-schuim met een soortelijk gewicht van 44kg/m<sup>3</sup>. Daarboven is een lekker zacht HR-schuim (50kg/m<sup>3</sup>) aangebracht in spievorm voor een goede knieholte ondersteuning en voorkomt dat men uit de bank „glijdt“.

De bollering bovenop het kussen is gemaakt een een superzacht HR-schuim (35kg/m<sup>3</sup>).

Het gehele kussen is ingepakt in een 300 grams dacron.

**Rugkussen**

Het rugkussen bestaat uit één stuk gevormd HR-schuim met een soortelijk gewicht van 44kg/m<sup>3</sup>. Het kussen uit één stuk is overtrokken met 300 grams dacron.

**Soft:**

**Zitkussen**

De basis bestaat uit een HR-schuim met een soortgelijk gewicht van 44kg/m<sup>3</sup>.

Daarboven is een zogenaamd traagschuim aangebracht die je compleet omsluit tijdens het zitten. Dit traagschuim is gesneden in een spievorm voor een goede knieholte ondersteuning en voorkomt dat men uit de bank „glijdt“.

De schuimkern wordt overtrokken met een dikke hoes gevuld met fiberrolletjes en “memory” schuimvlokken (verhouding 30/70%) die vervolgens is afgedekt met een tijk.

**Rugkussen**

Het rugkussen is gevuld met een combinatie van dacronrolletjes en “memory” schuimvlokken.

De vulling is verdeeld over verschillende compartimenten.

**Medium:**

**Seat cushion**

The base is made of comfortable HR foam with a specific gravity of 44kg/m<sup>3</sup>. This has been topped with a spline (specific weight 50kg/m<sup>3</sup>) of soft HR foam, fitted at the front for good knee support and to prevent “sliding” off the couch.

The rounded top of the cushion is made of an exceptionally soft HR foam (35kg/m<sup>3</sup>), and the entire pillow is wrapped in 300gr Dacron.

**Back cushion**

The back cushions are made of a single piece of moulded HR foam (specific weight 44kg/m<sup>3</sup>) and covered in a single piece of 300gr Dacron.

**Soft:**

**Seat cushion**

The base is made of HR foam with a specific gravity of 44kg/m<sup>3</sup>. This has been topped with a so-called memory foam that completely encloses you as you sit down. This memory foam has been cut into a wedge shape for good knee support and to prevent “sliding” off the couch. The foam core is topped with a thick cover filled with fibre curls and “memory” foam flakes (30/70% ratio), which is then covered with ticking.

**Back cushion**

The back cushion is filled with a combination of Dacron flocks and memory foam flakes, divided over different compartments.

**Medium:**

**Sitzkissen**

Die Basis besteht aus einem komfortablen HR-Schaum mit einer Dichte von 44 kg/m<sup>3</sup>. Darauf wird ein angenehm weicher HR-Schaum (50 kg/m<sup>3</sup>) angebracht, in Passfederform für eine gute Kniekehlenunterstützung und um zu vermeiden, dass man vom Sofa „rutscht“.

Die Ausbuchtung oben am Kissen wird aus einem superweichen HR-Schaum hergestellt (35 g/m<sup>3</sup>). Das gesamte Kissen wird in Dacron von 300 g/m<sup>2</sup> eingepackt.

**Rückenkissen**

Das Rückenkissen besteht aus einem Stück HR-Formschaum mit einer Dichte von 44 kg/m<sup>3</sup>. Das Kissen aus einem Stück wird mit 300 g/m<sup>2</sup> Dacron überzogen.

**Soft:**

**Sitzkissen**

Die Basis besteht aus einem komfortablen HR-Schaum mit einer Dichte von 44 kg/m<sup>3</sup>. Darüber wird ein sogenannter Memory Schaum angebracht, der Sie beim Sitzen vollständig umschließt. Dieser Memory Schaum wird in Passfederform geschnitten, für eine gute Kniekehlenunterstützung, und um zu vermeiden, dass man vom Sofa „rutscht“. Der Schaumkern wird mit einem dicken Bezug überzogen, der mit Faserkügelchen und Memory-Schaumflocken (Verhältnis 30/70%) gefüllt und anschließend mit einem Inlett abgedeckt wird.

**Rückenkissen**

Das Rückenkissen ist mit einer Kombination aus kleinen Dacron-Röllchen und Memory-Schaumflocken gefüllt. Die Füllung wird über verschiedene Kompartimente verteilt.

**Extra Soft:  
Zitkussen**

De basis bestaat uit een HR-schuim met een soortelijk gewicht van 44kg/m<sup>3</sup>. Daarboven is een zogenaamd traagschuim aangebracht die je compleet omsluit tijdens het zitten. Dit traagschuim is gesneden in een spie-vorm voor een goede knieholte ondersteuning en voorkomt dat men uit de bank „glijdt“. De schuimkern wordt overtrokken met een dikke hoes gevuld met 100% ganzen veren (Oekotex standard-100 gecertificeerd) die vervolgens is afgedekt met een tijk.

**Rugkussen**

Het rugkussen is gevuld met een 100% veredons (Oekotex standard-100 gecertificeerd). De vulling is verdeeld over verschillende compartimenten.

**Extra Soft:  
Seat cushion**

The base is made of HR foam with a specific gravity of 44kg/m<sup>3</sup>. This has been topped with a so-called memory foam that completely encloses you as you sit down. This memory foam has been cut into a wedge shape for good knee support and to prevent “sliding” off the couch. The foam core is topped with a thick cover filled with 100% goose feather down (OEKO-TEX® STANDARD 100-certified), which is then covered with ticking.

**Back cushion**

The back cushion is filled with 100% goose down (OEKO-TEX® STANDARD 100-certified), divided over different compartments.

**Extra Soft:  
Sitzkissen**

Die Basis besteht aus einem komfortablen HR-Schaum mit einer Dichte von 44 kg/m<sup>3</sup>. Darüber wird ein sogenannter Memory Schaum angebracht, der Sie beim Sitzen vollständig umschließt. Dieser

Memory-Schaum wird in Passfederform geschnitten, für eine gute Kniekehlenunterstützung, und um zu vermeiden, dass man vom Sofa „rutscht“. Der Schaumkern wird mit einem dicken Bezug überzogen, der zu 100 % mit Gänsefedern gefüllt ist (Zertifizierung nach Öko Tex Standard 100), und anschließend mit einem Inlett abgedeckt wird.

**Rückenkissen**

Das Rückenkissen ist zu 100% mit Daunefedern gefüllt (Zertifizierung nach Öko Tex Standard 100). Die Füllung wird über verschiedene Kompartimente verteilt.

**POTEN**

Zowel de houten en aluminium poten kunnen optioneel 2cm hoger worden besteld. De aluminium poten zijn optioneel ook nog 2 cm lager verkrijgbaar.

**Aluminium poten**

Standaard & 2 cm hoger in verschillende afwerkingen/kleuren:

- mat zwart gepoedercoat
- titanium
- matnikkel
- champagne
- eigen keuze  
(selectie RAL-kleuren:  
[www.montis.nl/ral](http://www.montis.nl/ral))

**Aluminium poten 2 cm lager:**

- mat zwart gepoedercoat
- eigen keuze  
(selectie RAL-kleuren:  
[www.montis.nl/ral](http://www.montis.nl/ral))

**Houten poten**

in verschillende afwerkingen:

- notenhout, matgelakt
- eikenhout, matgelakt
- eikenhout, zwart carbon gebeitst
- eikenhout, witgeolied

**FEET**

Both the wooden and aluminum legs can optionally be ordered 2cm higher. The aluminum legs are optionally also available 2 cm lower.

**Aluminium legs**

Standard & 2 cm higher in different finishes/colors:

- matt black, powder-coated
- titanium
- matt nickel
- champagne
- custom  
(selectie RAL-kleuren:  
[www.montis.nl/ral](http://www.montis.nl/ral))

**Aluminium legs 2 cm lower:**

- matt black, powder-coated
- custom  
(selectie RAL-kleuren:  
[www.montis.nl/ral](http://www.montis.nl/ral))

**Wooden legs**

in different finishes:

- walnut, matt-lacquered
- oak, matt-lacquered
- oak, carbon black stained
- oak, white oiled

**FÜSSE**

Sowohl die Holz- als auch die Aluminium- Füße können optional 2 cm höher bestellt werden. Die Aluminium- Füße sind optional auch 2 cm tiefer erhältlich.

**Aluminium-Füße** Standard & 2 cm höher in unterschiedlichen Beschichtungen/Farben:

- mattschwarz pulverbeschichtet
- titan
- matt Nickel
- champagner
- eigene Wahl  
(selectie RAL-kleuren:  
[www.montis.nl/ral](http://www.montis.nl/ral))

**Aluminium-Füße 2 cm tiefer:**

- mattschwarz pulverbeschichtet
- eigene Wahl  
(selectie RAL-kleuren:  
[www.montis.nl/ral](http://www.montis.nl/ral))

**Holzfüße**

in unterschiedlichen Lackierungen:

- Walnussholz, matt lackiert
- Eichenholz, matt lackiert
- Eichenholz, schwarz carbon gebeitst
- Eichenholz, weiß geölt

## CONSTRUCTIE

### *Poef en poef-gedeelte Dormeuse*

De poef en het poef-gedeelte van de dormeuse is niet voorzien van no-sag veren in de romp en heeft geen valling in de zitkussens. Dit geeft een andere zitcomfort dan bij de zittingen van de verschillende banken.

## OTIS EN OTIS XL

De OTIS XL is de lounge-versie van de OTIS.  
Het zitgedeelte is 13cm dieper.  
De OTIS en de OTIS XL kunnen aan elkaar worden gekoppeld.

## HOEBANK OTIS EN OTIS XL

De hoebanken van de OTIS en OTIS XL zijn uitsluitend te gebruiken om een hoek-combinatie te creëren en niet bedoeld om als een losse bank te gebruiken.

## BRANDVEILIG

De OTIS en OTIS XL banken zijn te verkrijgen in British Standard 5852, part 1 en 2, en CA, TB 117-2013.

## CONSTRUCTION

### *Footstool & footstool section dormeuse*

The footstool and footstool section of the dormeuse don't feature no-sag springs in the body, nor does it have a drop in the seat cushions. This makes for a different kind of comfort experience than the seating elements of our various sofas.

## OTIS & OTIS XL

The OTIS XL is the lounge version of the OTIS, with a seating area that is 13cm deeper.  
The OTIS and the OTIS XL can be linked together as desired.

## CORNER SOFAS OTIS & OTIS XL

The OTIS and OTIS XL corner sofas should be exclusively used to create corner combinations, and are not intended to be used as a standalone sofa.

## FIRE-SAFE

The OTIS and OTIS XL sofas are available in British Standard 5852, part 1 and 2, and CA, TB. 117-2013.

## KONSTRUKTION

### *Puff und Puff-Teil Dormeuse*

Der Puff und der Puff-Teil der Dormeuse sind nicht mit No-Sag-Federn im Rumpf ausgestattet und die Sitzkissen haben keine Neigung. Das ergibt einen anderen Sitzkomfort als die Sitze der verschiedenen Sofas.

## OTIS UND OTIS XL

OTIS XL ist die Lounge-Version der OTIS. Der Sitzbereich ist 13 cm tiefer.  
OTIS und OTIS XL können miteinander verbunden werden.

## ECKBANK OTIS UND OTIS XL

Die Eckbänke der OTIS und OTIS XL lassen sich ausschließlich zum Kreieren einer Eckkombination verwenden und sind nicht zur Nutzung als separate Sofas vorgesehen.

## FEUERFEST

Die OTIS und OTIS XL Sofas sind als British Standard 5852, part 1 und 2, sowie CA, TB 117-2013 erhältlich.

## DORMEUSE TAFEL

### Romp

Een constructie van gefineerde Multiplex platen of een gelakte MDF platen.

### Uitvoeringen

- Eiken gefineerdn:
  - naturel
  - houtskool
  - gerookt
  - hazelnoot
  - kastanje
- MDF zijdeglans gelakt in 37 RAL-kleuren. Zelfde kleuren als waarin de Aluminium poten van de OTIS in kunnen worden gelakt.

### Dormeuse

De tafels worden op een OTIS dormeuse of OTIS XL dormeuse bank gemonteerd. De tafel kan zowel op een linker- als rechteruitvoering worden gemonteerd (let op: er is geen verschil tussen een linker- of rechter uitvoering van de tafels!). De twee stekkers benodigd voor het aansluiten van het geïntegreerde stopcontact en Qi lader komen onder de bank uit.

### Electrificatie

De tafels is voorzien van een zwart stopcontact en een usb-charger (QC2.0, 2,1A). Standaard gaat het om een stopcontact voor de stekkers E en F (de meeste Europese landen). Optioneel kunnen we ook voor stopcontact G (geschikt voor o.a. UK) en B (USA) leveren. Handige site welke stekkers in welk land worden gebruikt: [www.iec.ch/worldplugs/map.htm](http://www.iec.ch/worldplugs/map.htm)

### Qi lader

De tafel is tevens voorzien van een Qi lader voor het draadloos laden van mobiele telefoons. Deze is weggewerkt in het bovenblad van de tafels. De IQ lader heeft een 10W output en onder-steunt Apple & Samsung Fast Charge. Daarnaast is hij voorzien van een FOD detectie (hij detecteert als er een niet-Qi device of object op de oplader ligt en schakelt zichzelf uit).

## DORMEUSE TABLE

### Body

Made of finished plywood or lacquered MDF.

### Finishes

- Finished oak, available in:
  - natural
  - charcoal
  - smoked
  - hazelnut
  - chestnut
- MDF with satin finish in 37 RAL colours. The aluminium legs of the OTIS are available in the same colour range.

### Dormeuse

This table can be combined with our OTIS dormeuse sofa (either standard or XL), and can be mounted on either the left or the right side of the sofa. Please note that this table doesn't come in a different left or right-handed version. The two power plugs connected to the built-in power socket and Qi charger connect below the sofa.

### Electricity supply

The table is equipped with a black power socket and a USB charger (QC2.0, 2.1A). As standard, this is a socket for E and F plugs (most European countries). We can also optionally supply the G (suitable for the UK, among other countries) and B sockets (USA). Great site to find out which plugs are used in which country: [www.iec.ch/worldplugs/map.htm](http://www.iec.ch/worldplugs/map.htm)

### Qi Charger

The table is also equipped with an Qi charger for wireless charging of mobile phones. This has been housed in the top of the tables. The Qi charger has a 10W output and supports Apple & Samsung Fast Charge. In addition, it has been equipped with FOD detection (it detects when there is a non-Qi device or object on the charger and switches itself off).

## DORMEUSE TISCH

### Rumpf

Eine Konstruktion aus furnierten Multiplex-Platten oder lackierten MDF-Platten

### Ausführungen

- Eichenfurnier:
  - Naturell
  - Holzkohle
  - Geräuchert
  - Haselnuss
  - Kastanie
- MDF seidenmatt lackiert in 37 RAL-Farben. Die gleichen Farben, in denen die Aluminiumfüße des OTIS lackiert werden können.

### Dormeuse

Die Tische werden auf einem OTIS- Dormeuse- oder OTIS-XL- Dormeuse-Sofa montiert. Der Tisch kann links oder rechts montiert werden (Hinweis: Es gibt keinen Unterschied zwischen rechter und linker Ausführung der Tische!). Die beiden Stecker, die zum Anschluss der integrierten Steckdose und des Qi-Ladegeräts benötigt werden, befinden sich an der Unterseite des Sofas.

### Elektrifizierung

Die Tische sind mit einer schwarzen Steckdose und einem USB-Ladegerät (QC2.0, 2.1 A) ausgestattet. Standardsteckdose für Steckertyp E und F (für die meisten europäischen Länder). Optional auch mit Steck-dose G (für u. a. GB) und B (USA) erhältlich. Eine Übersicht der Stecker-typen der einzelnen Länder ist hier zu finden: [www.iec.ch/worldplugs/map.htm](http://www.iec.ch/worldplugs/map.htm)

### Qi-Ladestation

Beide Elemente verfügen auch über eine Qi-Ladestation zum kabellosen Aufladen von Smartphones. Diese befindet sich in der oberen Tischplatte. Die Qi-Ladestation besitzt eine Leistung von 10 W und unterstützt Apple und Samsung Fast Charge. Außerdem besitzt sie eine FOD Erkennung und schaltet sich aus, wenn kein Qi-Gerät oder Objekt auf der Ladestation liegt.

## ARMTAFEL

### Romp

Een constructie van gefineerde Multiplex platen of een gelakte MDF platen. Voorzien van mat-zwart gelakte stalen profielen voor de ophanging en een metalen rooster (optioneel bij de armtafel power/QI).

### Uitvoeringen

- Eiken gefineerd:
  - naturel
  - houtskool
  - gerookt
  - hazelnoot
  - kastanje
- MDF zijdeglans gelakt in 37 RAL-kleuren. Zelfde kleuren als waarin de Aluminium poten van de OTIS in kunnen worden gelakt.

### Opties

Er zijn naast de armtafel en de armtafel XL (bestemd voor alle OTIS XL banken) ook nog in beide uitvoeringen een power/QI uitvoering. Deze uitvoering heeft een stopcontact plus usb-aansluiting en een QI oplader voor mobiele telefoons geïntegreerd in de tafel. De twee stekkers benodigd voor het aansluiten van het geïntegreerde stopcontact en QI lader komen onder de bank uit ter hoogte van de achterpoot. Tevens moet aangegeven worden bij de bestelling aan welke kant de tafel moet worden geplaatst (voorstaand: links of rechts).

### Plaatsen

De armtafels kunnen op elke romp worden geplaatst waar ook een arm geplaatst kan worden. De volgende uitvoeringen zijn geschikt hiervoor (zowel in standaard als XL uitvoering):

- Alle banken zonder armen
- Alle banken met 1 arm
- De hoekbanken zonder arm.
- Beide chaise longues.
- Beide chaise longues zonder arm.

### Maximaal gewicht

Het tafeltje is geschikt om een gewicht van maximaal 12 kg te kunnen dragen.

## ARM TABLE

### Body

Made of finished plywood or lacquered MDF. Fitted with a matt-black lacquered steel framework for suspension and a metal panel (the latter being optional for the arm table with a built-in power socket/QI charger).

### Finishes

- Finished oak, available in:
  - natural
  - charcoal
  - smoked
  - hazelnut
  - chestnut
- MDF with satin finish in 37 RAL colours. The aluminium legs of the OTIS are available in the same colour range.

### Options

In addition to the regular and the XL version (which suits all OTIS XL sofas), we also offer both sizes in a plus model, which comes with a built-in power socket, USB port and QI charger for mobile phones. The two power plugs connected to the built-in power socket and QI charger connect below the sofa at the level of the back leg. When ordering, please specify the desired placement of the table (left or right).

### Placement

The arm table can be mounted on each of our sofa elements that have room for an arm rest. This goes for our following models (standard versions as well as XL):

- All armless sofas
- All sofas with 1 arm
- All corner sofas without arms
- Both chaise longues (with or without arms)

### Weight limit

This table was designed to hold up to 12 kg (or 26 lb.).

## ARMTISCH

### Rumpf

Konstruktion aus furnierten Multiplex-Platten oder lackierten MDF-Platten. Ausgestattet mit matt-schwarz lackierten Stahlprofilen für die Aufhängung und einem Metallgitter (optional für den Armtisch Power/QI).

### Ausführungen

- Eichenfurnier:
  - Naturell
  - Holzkohle
  - Geräuchert
  - Haselnuss
  - Kastanie
- MDF seidenmatt lackiert in 37 RAL-Farben. Die gleichen Farben, in denen die Aluminiumfüße des OTIS lackiert werden können.

### Optionen

Neben dem Armtisch und dem XL-Armtisch (für alle OTIS XL-Sofas) sind beide Größen auch in einer Power/QI-Version erhältlich. Diese Version hat eine Steckdose plus USB-Anschluss und eine im Tisch integrierte QI-Ladestation für Mobiltelefone. Die beiden Stecker, die zum Anschluss der integrierten Steckdose und des QI-Ladegeräts erforderlich sind, befinden sich unter dem Sofa auf Höhe des hinteren Fußes. Außerdem sollten Sie in Ihrer Bestellung angeben, auf welcher Seite Sie den Tisch wünschen (vorne: links oder rechts).

### Positionierung

Die Armtische können an jedem Rumpf angebracht werden, an dem ein Arm befestigt werden kann. Dazu eignen sich folgende Ausführungen (sowohl in standard- als auch in XL-Version):

- Alle Sofas ohne Armlehnen
- Alle Sofas mit 1 Arm
- Die Ecksofas ohne Armlehnen
- Beide Chaise Longues
- Beide Chaise Longues ohne Arm

### Maximales Gewicht

Das Tischchen ist für ein maximales Gewicht von 12 kg geeignet.

### **Montage**

De armtafels worden los van de bank geleverd. Onder de bank is een U-profiel gemonteerd waarop de armtafel kan worden gemonteerd. Er is een mogelijkheid om de tafel in zowel de lengte als breedterichting waterpas af te stellen.

### **OPTIONAAL**

#### **Electrificatie**

De tafels is voorzien van een zwart stopcontact en een usb-charger (QC2.0, 2,1A). Standaard gaat het om een stopcontact voor de stekkers E en F (de meeste Europese landen). Optioneel kunnen we ook voor stopcontact G (geschikt voor o.a. UK) en B (USA) leveren. Handige site welke stekkers in welk land worden gebruikt: [www.iec.ch/worldplugs/map.htm](http://www.iec.ch/worldplugs/map.htm)

#### **Qi lader**

De tafel is tevens voorzien van een Qi lader voor het draadloos laden van mobiele telefoons. Deze is weggewerkt in het bovenblad van de tafels. De IQ lader heeft een 10W output en ondersteunt Apple & Samsung Fast Charge. Daarnaast is hij voorzien van een FOD detectie (hij detecteert als er een niet-Qi device of object op de oplader ligt en schakelt zichzelf uit).

### **Assembly**

All arm tables are delivered separately from the sofa. They can be manually mounted using the U-profile underneath the sofa. The table can be levelled both vertically and horizontally.

### **OPTIONAL**

#### **Electricity Supply**

The table is equipped with a black power socket and a USB charger (QC2.0, 2.1A). As standard, this is a socket for E and F plugs (most European countries). We can also optionally supply the G (suitable for the UK, among other countries) and B sockets (USA). Great site to find out which plugs are used in which country: [www.iec.ch/worldplugs/map.htm](http://www.iec.ch/worldplugs/map.htm)

#### **Qi Charger**

The table is also equipped with an Qi charger for wireless charging of mobile phones. This has been housed in the top of the tables. The IQ charger has a 10W output and supports Apple & Samsung Fast Charge. In addition, it has been equipped with FOD detection (it detects when there is a non-Qi device or object on the charger and switches itself off).

### **Montage**

Die Armtische werden separat vom Sofa geliefert. Unter dem Sofa ist ein U-Profil montiert, an dem der Armtisch befestigt werden kann. Es besteht die Möglichkeit, den Tisch horizontal und vertikal zu justieren.

### **OPTIONAL**

#### **Elektrifizierung**

Die Tische sind mit einer schwarzen Steckdose und einem USB-Ladegerät (QC2.0, 2.1A) ausgestattet. Standardsteckdose für Steckertyp E und F (für die meisten europäischen Länder). Optional auch mit Steckdose G (für u. a. GB) und B (USA) erhältlich. Eine Übersicht der Stecker-typen der einzelnen Länder ist hier zu finden: [www.iec.ch/worldplugs/map.htm](http://www.iec.ch/worldplugs/map.htm)

#### **Qi-Ladestation**

Beide Elemente verfügen auch über eine Qi-Ladestation zum kabellosen Aufladen von Smartphones. Diese befindet sich in der oberen Tischplatte. Die Qi-Ladestation besitzt eine Leistung von 10 W und unterstützt Apple und Samsung Fast Charge. Außerdem besitzt sie eine FOD Erkennung und schaltet sich aus, wenn kein Qi-Gerät oder Objekt auf der Ladestation liegt.

## RUGTAFEL

### Romp

Het blad is gemaakt van gefineerde Multiplex plaat of een gelakte MDF plaat. De rugplaat is een metalen gebogen plaat gepoedercoated in matzwart structuur.

### Uitvoeringen

- Eiken gefineerd:
  - naturel
  - houtskool
  - gerookt
  - hazelnoot
  - kastanje
- MDF zijdeglans gelakt in 37 RAL-kleuren. Zelfde kleuren als waarin de Aluminium poten van de OTIS in kunnen worden gelakt.

### Plaatsing

De OTIS armtafel kan op alle ruggen van de OTIS en OTIS XL elementen worden geplaatst.

**Let op:** Als de armtafel langere tijd op 1 plek over de rug zit geschoven is het mogelijk dat een lichte afdruk in de stof of leer achterblijft.

### Maximaal gewicht

Het tafeltje is geschikt om een gewicht van maximaal 5 kg te kunnen dragen.

## CONSOLE TABLE

### Body

The top is made of finished plywood or lacquered MDF. The back panel consists of a metal curved plate in matt black, structured powder coating.

### Finishes

- Finished oak, available in:
  - naturel
  - charcoal
  - smoked
  - hazelnut
  - chestnut
- MDF with satin finish in 37 RAL colours. The aluminium legs of the OTIS are available in the same colour range.

### Placement

Our console table is a welcome addition to any OTIS or OTIS XL back element, and always a perfect fit. **Please note:** the console table may leave a slight imprint in the fabric or leather upholstery when mounted in the same place for a long amount of time.

### Weight limit

This table was designed to hold up to 5 kg (or 11 lb.).

## RÜCKENTISCH

### Rumpf

Die Platte ist aus furniertem Multiplex oder lackiertem MDF gefertigt. Die Rückenlehne ist eine gebogene Metallplatte, pulverbeschichtet in mattschwarz.

### Ausführungen

- Eichenfurnier:
  - Naturell
  - Holzkohle
  - Geräuchert
  - Haselnuss
  - Kastanie
- MDF seidenmatt lackiert in 37 RAL-Farben. Die gleichen Farben, in denen die Aluminiumfüße des OTIS lackiert werden können.

### Platzierung

Der OTIS-Armtisch kann auf alle Rückseiten der Elemente OTIS und OTIS XL montiert werden. **Hinweis:** Wenn der Armtisch längere Zeit an einer Stelle aufgelegt hat, kann es zu einem leichten Abdruck im Stoff oder Leder kommen.

### Maximales Gewicht

Das Tischchen ist für ein maximales Gewicht von 5 kg geeignet.



## BIJZETTAFEL

### Romp

De tafel is gemaakt van gefineerde Multiplex plaat of een gelakte MDF plaat. Aan de onderkant is een gepoedercoate metalen plaat aangebracht om de basis van het tafeltje te verzwaren. De poet van het tafeltje is voorzien van Wagner Quick Click doppen met een Duo dop (aan twee kanten te gebruiken, 1 kant voor zien van vilt, de andere kant voorzien van een Hyperglide vlak)

### Uitvoeringen

- Eiken gefineerd:
  - naturel
  - houtskool
  - gerookt
  - hazelnoot
  - kastanje
- MDF zijdeglans gelakt in 37 RAL-kleuren. Zelfde kleuren als waarin de Aluminium poten van de OTIS in kunnen worden gelakt.

## HOOFDSTEUN

### Verstelbaar

Het hoofdstekussen kan 35 graden naar voren worden gekanteld

### Frame

metalen strip, matzwart structuur gepoedercoated. In de hoofdstek zelf zit een multiplex plaat die d.m.v scharnieren is verbonden aan het metalen frame.

### Schuim

Een kern van zacht HR-schuim omhult met een hoes van 300 grams dacron.

### Stoffering

Afneembare hoes van stof of leer

### Brandveilig

Het hoofdstekussen is te verkrijgen in British Standard 5851, part 1 en 2, en CA, TB-117- 2013

## SIDE TABLE

### Body

The top is made of finished plywood or lacquered MDF with a powder-coated metal plate at the base to add weight. The base has been fitted with Wagner QuickClick DUO gliding caps, which offer two gliding surfaces for each type of floor covering (one side is felted, the other side made of hyper glide thermoplastic).

### Finishes

- Finished oak, available in:
  - natural
  - charcoal
  - smoked
  - hazelnut
  - chestnut
- MDF with satin finish in 37 RAL colours. The aluminium legs of the OTIS are available in the same colour range.

## HEADREST

### Adjustable

The headrest cushion can be tilted 35 degrees forward for perfect comfort.

### Frame

Features a metal strip in matt black, structured powder coating. The inside of the headrest contains a plywood plate, connected to the metal frame with hinges.

### Foam

Has a core of soft HR foam, covered in 300gr Dacron.

### Upholstery

The removable cover comes in fabric or leather.

### Fireproof

The headrest cushion is available in British Standard 5851 (part 1 and 2), as well as CA, TB-117- 2013.

## BEISTELLTISCH

### Rumpf

Der Tisch ist aus furnierten Multiplex-Platten oder einer lackierten MDF-Platte gefertigt. An der Unterseite befindet sich eine pulverbeschichtete Metallplatte um das Tischchen zu beschweren. Der Tischfuß ist mit Wagner Quick Click-Kappen mit Duo-Kappe ausgestattet (beidseitig verwendbar, eine Seite ist mit Filz, die andere mit einer Hyperglide-Oberfläche ausgestattet).

### Ausführungen

- Eichenfurnier:
  - Naturell
  - Holzkohle
  - Geräuchert
  - Haselnuss
  - Kastanie
- MDF seidenmatt lackiert in 37 RAL-Farben. Die gleichen Farben, in denen die Aluminiumfüße des OTIS lackiert werden können.

## KOPFSTÜTZEN

### Verstellbar

Das Kopfstützpolster kann um 35 Grad nach vorne geneigt werden.

### Rahmen

Metallband, mattschwarz pulverbeschichtete Struktur. In der Kopfstütze selbst befindet sich eine Multiplexplatte, die durch Scharniere mit dem Metallrahmen verbunden ist.

### Schaumstoff

Ein Kern aus weichem HR-Schaum, umwickelt mit einer Hülle aus 300g Dacron

### Polsterung

Abnehmbarer Bezug aus Stoff oder Leder.

### Feuerbeständigkeit

Das Kopfstützpolster ist in British Standard 5851, Teil 1 und 2, und CA, TB-117- 2013 erhältlich.

# OTIS

Johan van Hengel 2020

---



OTIS – tobago clay – titanium

# OTIS

Johan van Hengel 2020

---



OTIS – steelcut trio 996 – RAL 6012



OTIS – country antrazit – titanium



# OTIS

Johan van Hengel 2020

---



OTIS – panama 60 – titanium



# OTIS

Johan van Hengel 2020

---



OTIS – vita 03 – walnut, matt-lacquered



OTIS – orsetto 01 – oak, matt-lacquered

# OTIS

Johan van Hengel 2020

---



Side table



Console table



Arm table



Dormeuse table



# OTIS

Johan van Hengel 2020



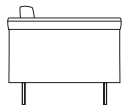

1,5-Z

114,5 cm / 45°

82,5 cm / 32,5°

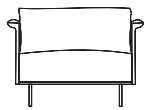

20 cm / 79°  
45 cm / 177°  
66 cm / 26°  
81 cm / 31,9°

1,5-Z

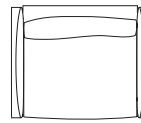

58 cm / 22,8°  
88 cm / 34,6°

2-Z

142 cm / 55,9°

110 cm / 43,3°

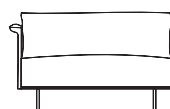

20 cm / 79°  
45 cm / 177°  
66 cm / 26°  
81 cm / 31,9°

2-Z



58 cm / 22,8°  
88 cm / 34,6°

2,5-Z

169,5 cm / 66,7°

137,5 cm / 54,1°



20 cm / 79°  
45 cm / 177°  
66 cm / 26°  
81 cm / 31,9°

2,5-Z



58 cm / 22,8°  
88 cm / 34,6°

2,5-Z

169,5 cm / 66,7°

137,5 cm / 54,1°

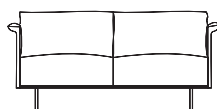

20 cm / 79°  
45 cm / 177°  
66 cm / 26°  
81 cm / 31,9°

2,5-Z

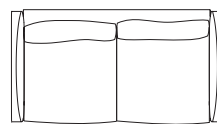

58 cm / 22,8°  
88 cm / 34,6°

3-Z

197 cm / 77,5°

165 cm / 65°

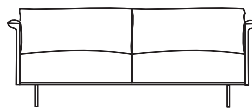

20 cm / 79°  
45 cm / 177°  
66 cm / 26°  
81 cm / 31,9°

3-Z

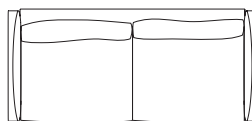

58 cm / 22,8°  
88 cm / 34,6°

3,5-Z

224,5 cm / 88,4°

192,5 cm / 75,8°

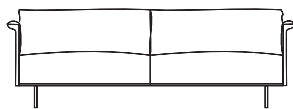

20 cm / 79°  
45 cm / 177°  
66 cm / 26°  
81 cm / 31,9°

3,5-Z

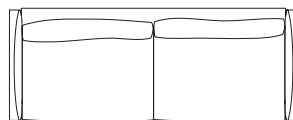

58 cm / 22,8°  
88 cm / 34,6°



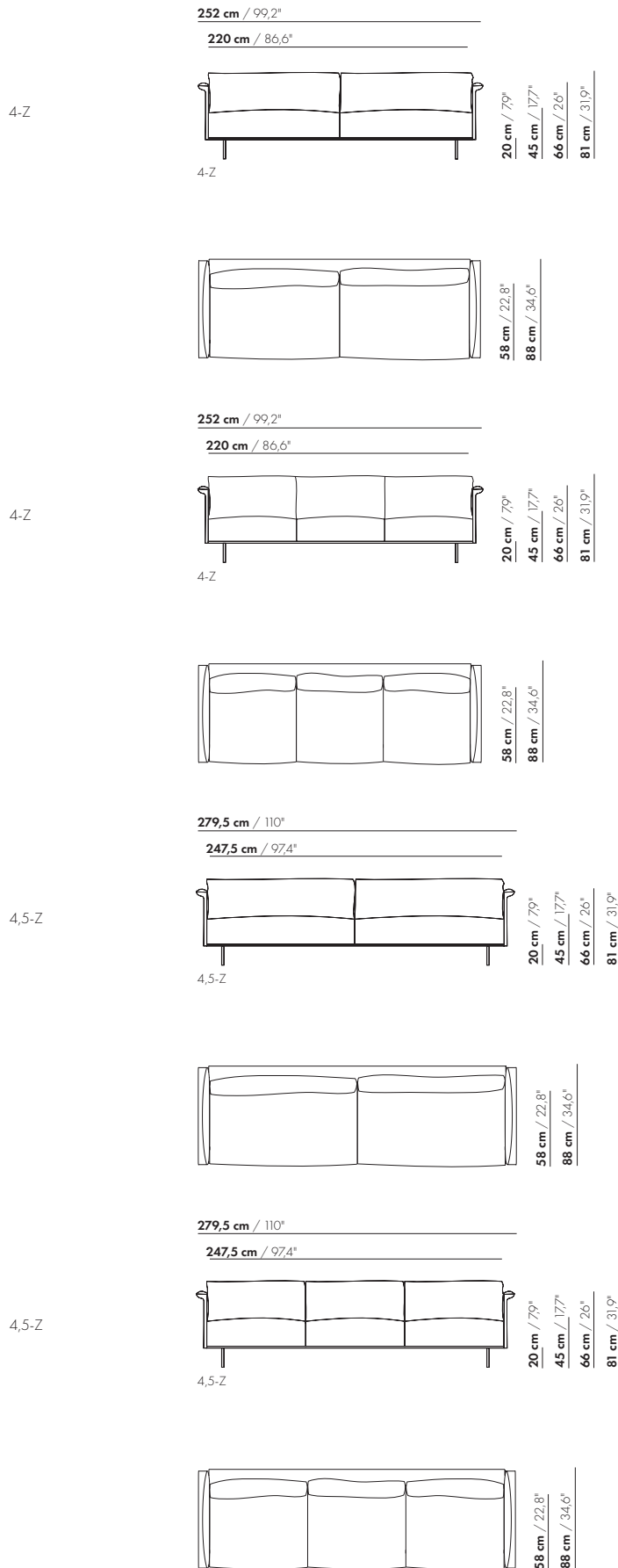

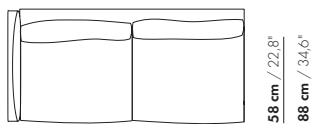
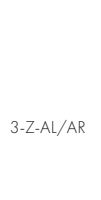
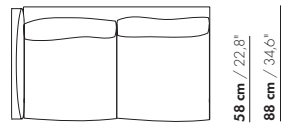
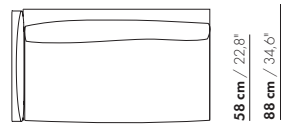
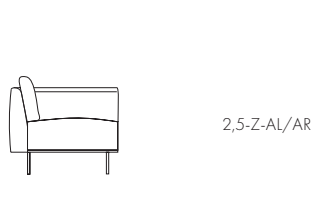
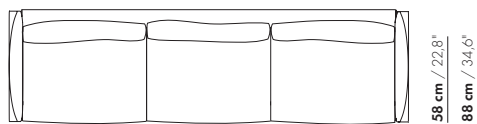
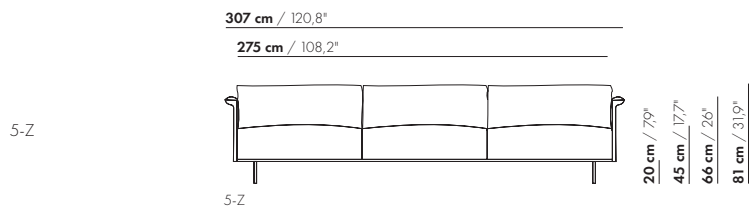
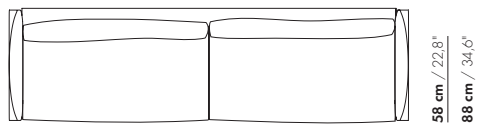
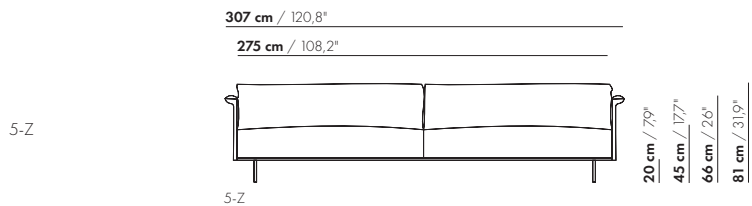

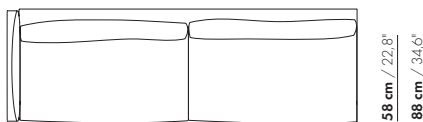
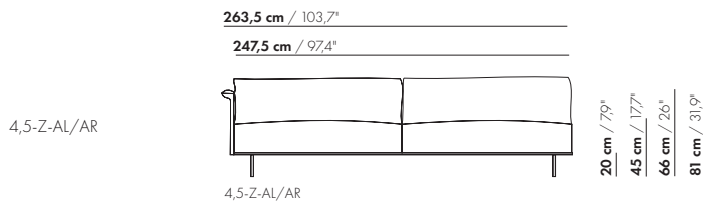
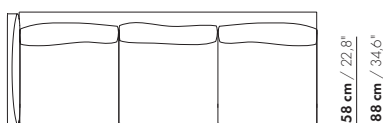
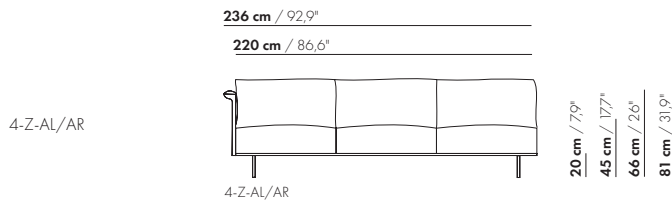
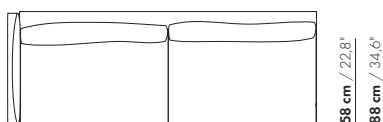
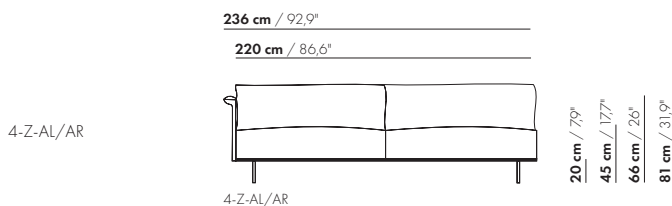
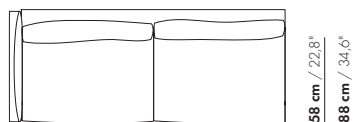
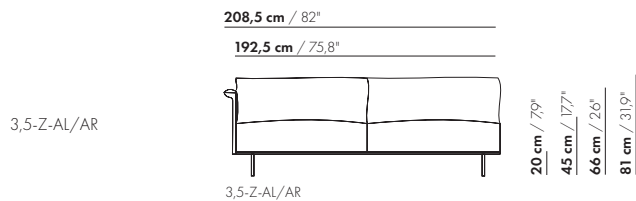

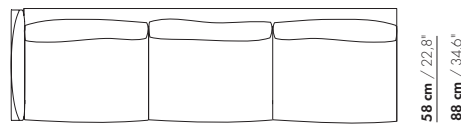
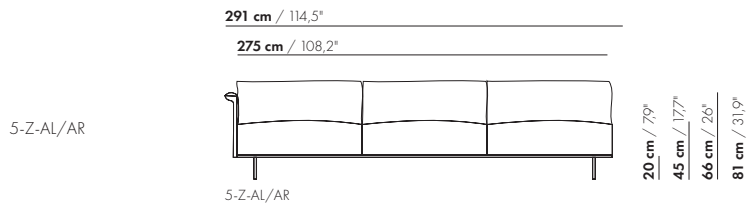
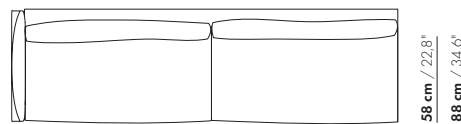
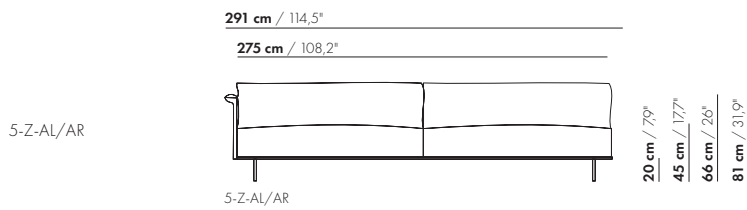
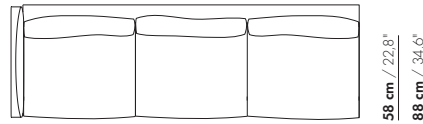
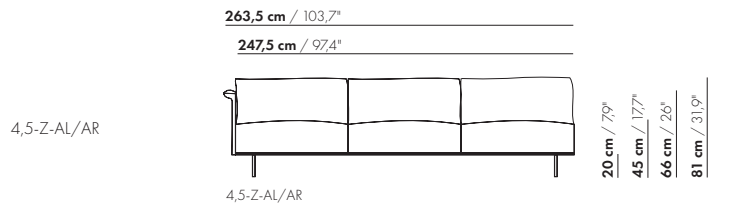

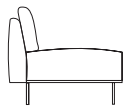

1,5-Z-ZA

82,5 cm / 32,5"

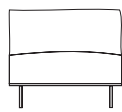

1,5-Z-ZA

20 cm / 7,9"  
45 cm / 17,7"  
81 cm / 31,9"

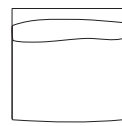

58 cm / 22,8"  
88 cm / 34,6"

2-Z-ZA

110 cm / 43,3"



2-Z-ZA

20 cm / 7,9"  
45 cm / 17,7"  
81 cm / 31,9"



58 cm / 22,8"  
88 cm / 34,6"

2,5-Z-ZA

137,5 cm / 54,1"

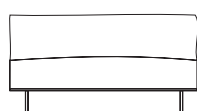

2,5-Z-ZA

20 cm / 7,9"  
45 cm / 17,7"  
81 cm / 31,9"



58 cm / 22,8"  
88 cm / 34,6"

2,5-Z-ZA

137,5 cm / 54,1"

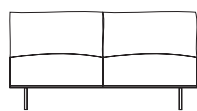

2,5-Z-ZA

20 cm / 7,9"  
45 cm / 17,7"  
81 cm / 31,9"

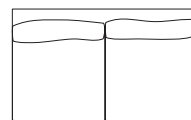

58 cm / 22,8"  
88 cm / 34,6"

3-Z-ZA

165 cm / 65"

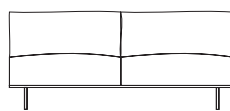

3-Z-ZA

20 cm / 7,9"  
45 cm / 17,7"  
81 cm / 31,9"

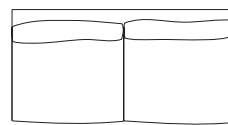

58 cm / 22,8"  
88 cm / 34,6"

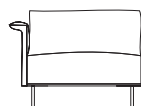

3,5-Z-D-PL/PR

265,5 cm / 104,5"

176,5 cm / 69,5"

55 cm / 21,6"

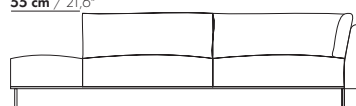

3,5-Z-D-PL/PR

20 cm / 7,9"  
45 cm / 17,7"  
66 cm / 26"  
81 cm / 31,9"

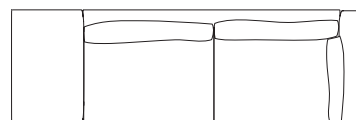

58 cm / 22,8"  
88 cm / 34,6"

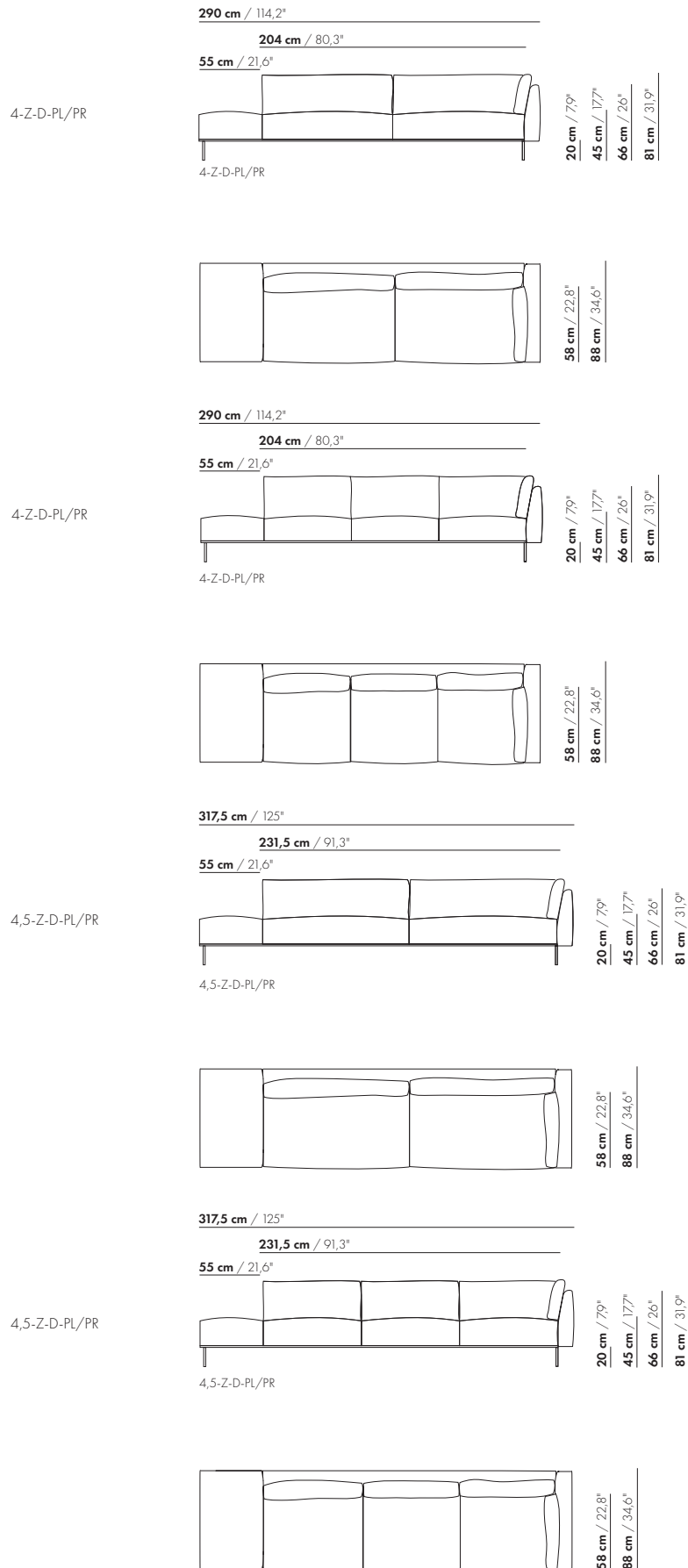

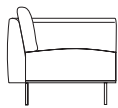

3-Z-H-AL/AR

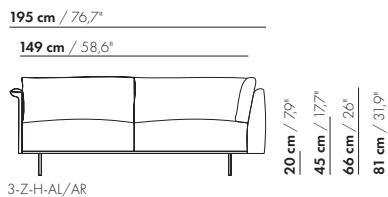

3-Z-H-AL/AR

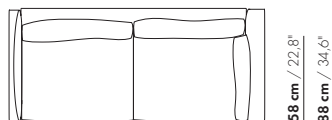

3,5-Z-H-AL/AR

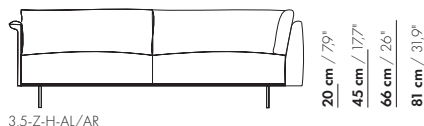

3,5-Z-H-AL/AR

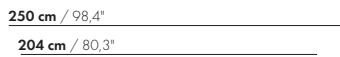
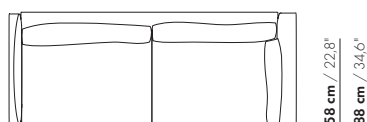

4-Z-H-AL/AR



4-Z-H-AL/AR

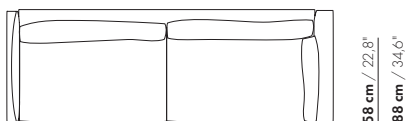

4-Z-H-AL/AR

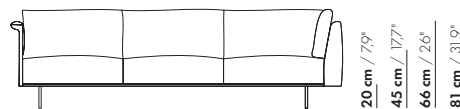

4-Z-H-AL/AR

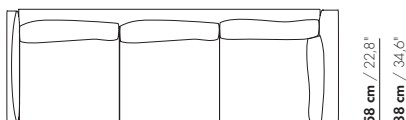

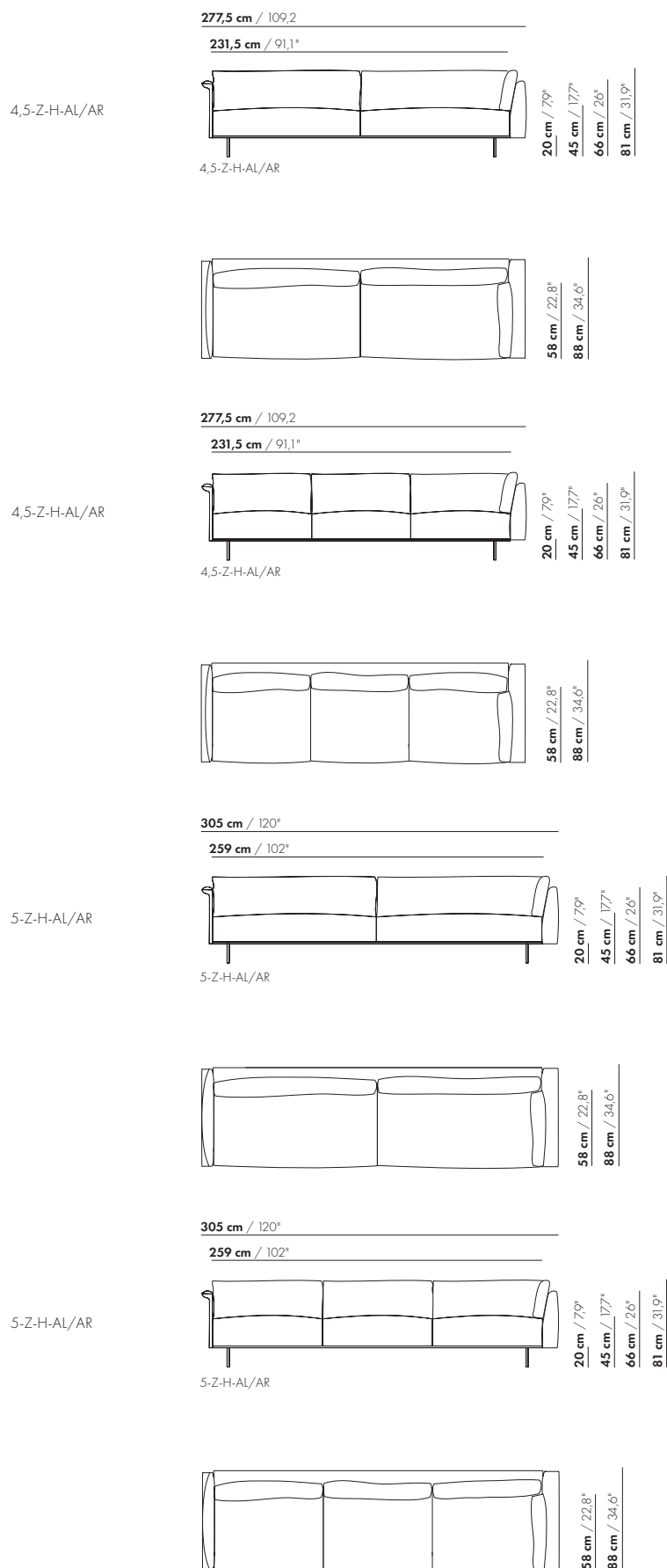



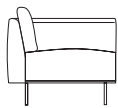

3-Z-H L/R-E

179 cm / 70,9°

149 cm / 58,6°

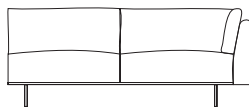

3-Z-H L/R-E

20 cm / 7,9°

45 cm / 17,7°

66 cm / 26°

81 cm / 31,9°

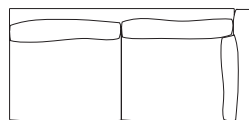

58 cm / 22,8°

88 cm / 34,6°

206,5 cm / 81,3°

176,5 cm / 69,5°

3,3-Z-H L/R-E

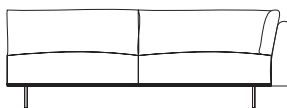

3,3-Z-H L/R-E

20 cm / 7,9°

45 cm / 17,7°

66 cm / 26°

81 cm / 31,9°

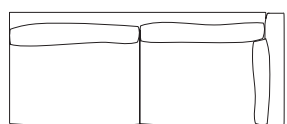

58 cm / 22,8°

88 cm / 34,6°

234 cm / 92,1°

204 cm / 80,3°

4-Z-Z-H L/R-E

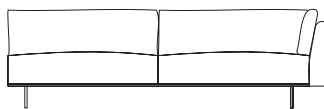

4-Z-H L/R-E

20 cm / 7,9°

45 cm / 17,7°

66 cm / 26°

81 cm / 31,9°

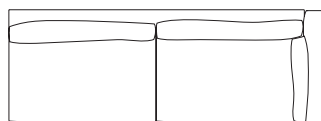

58 cm / 22,8°

88 cm / 34,6°

234 cm / 92,1°

204 cm / 80,3°

4-Z-Z-H L/R-E

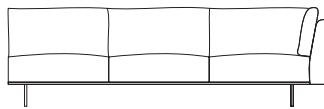

4-Z-H L/R-E

20 cm / 7,9°

45 cm / 17,7°

66 cm / 26°

81 cm / 31,9°

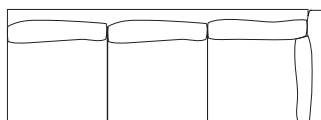

58 cm / 22,8°

88 cm / 34,6°

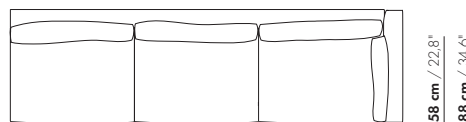
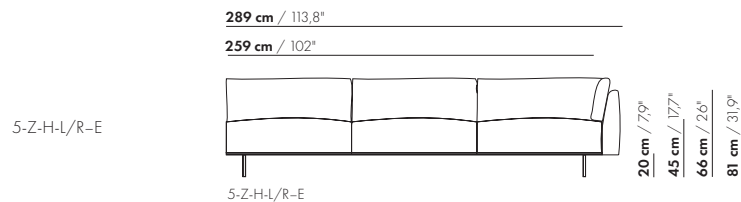
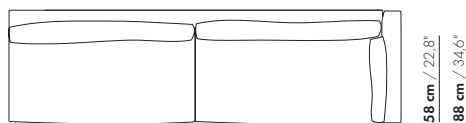
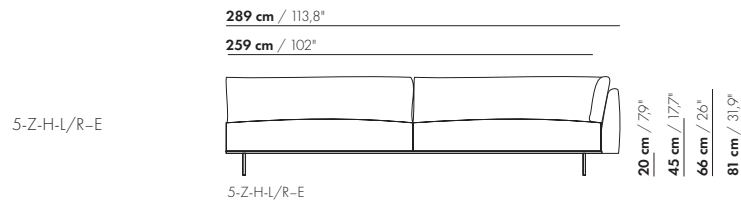
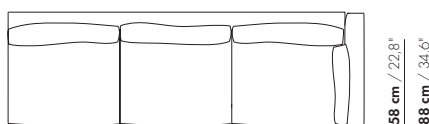
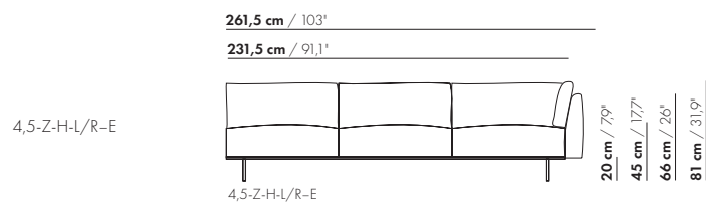
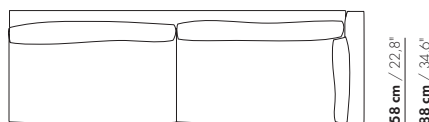
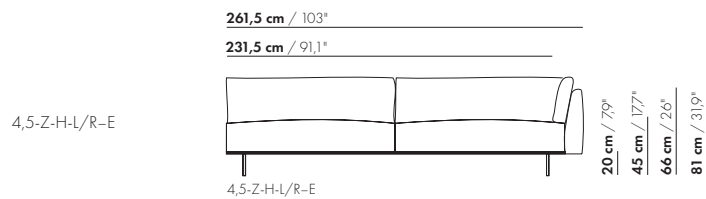

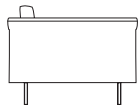

1,5-Z-XL

114,5 cm / 45°

82,5 cm / 32,5°

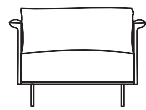

1,5-Z-XL

20 cm / 79°  
45 cm / 177°  
66 cm / 26°  
81 cm / 31,9°

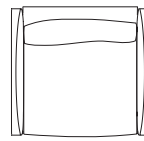

71 cm / 28°  
101 cm / 39,7°

2-Z-XL

142 cm / 55,9°

110 cm / 43,3°



2-Z-XL

20 cm / 79°  
45 cm / 177°  
66 cm / 26°  
81 cm / 31,9°

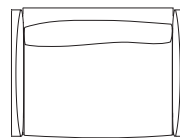

71 cm / 28°  
101 cm / 39,7°

2,5-Z-XL

169,5 cm / 66,7°

137,5 cm / 54,1°



2,5-Z-XL

20 cm / 79°  
45 cm / 177°  
66 cm / 26°  
81 cm / 31,9°



71 cm / 28°  
101 cm / 39,7°

2,5-Z-XL

169,5 cm / 66,7°

137,5 cm / 54,1°

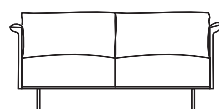

2,5-Z-XL

20 cm / 79°  
45 cm / 177°  
66 cm / 26°  
81 cm / 31,9°

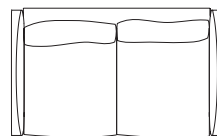

71 cm / 28°  
101 cm / 39,7°

3-Z-XL

197 cm / 77,5°

165 cm / 65°

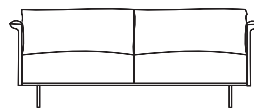

3-Z-XL

20 cm / 79°  
45 cm / 177°  
66 cm / 26°  
81 cm / 31,9°

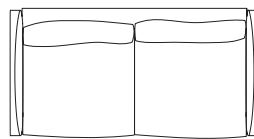

3-Z-XL

71 cm / 28°  
101 cm / 39,7°

3,5-Z-XL

224,5 cm / 88,4°

192,5 cm / 75,8°

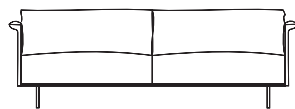

3,5-Z-XL

20 cm / 79°  
45 cm / 177°  
66 cm / 26°  
81 cm / 31,9°

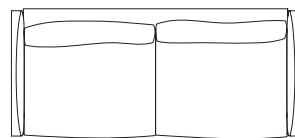

3,5-Z-XL

71 cm / 28°  
101 cm / 39,7°

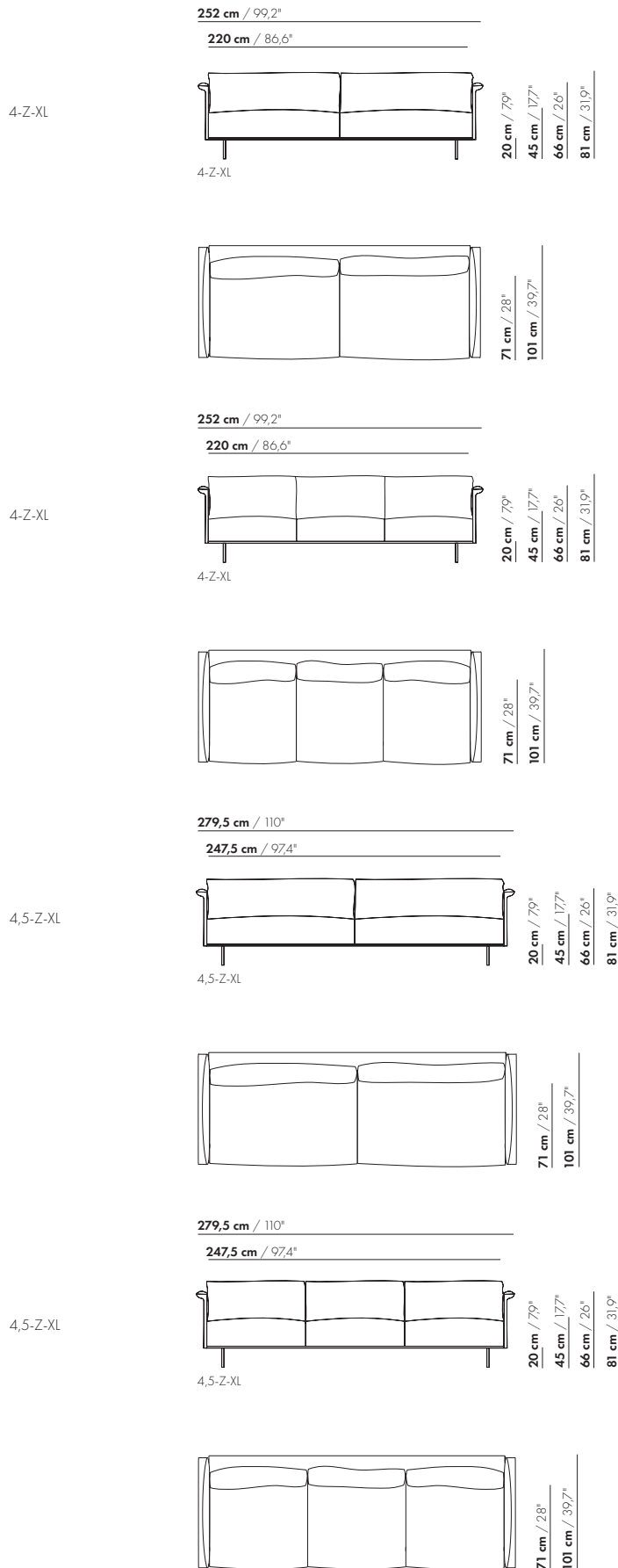

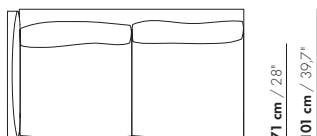
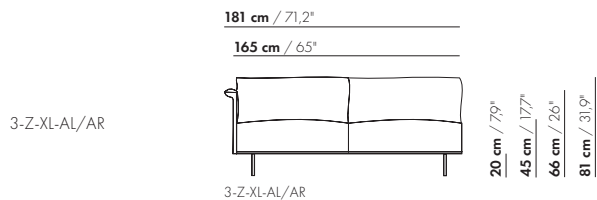
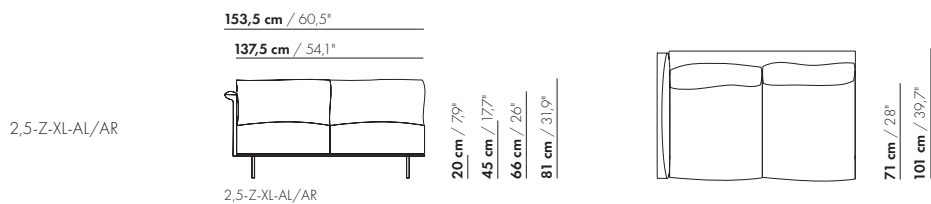
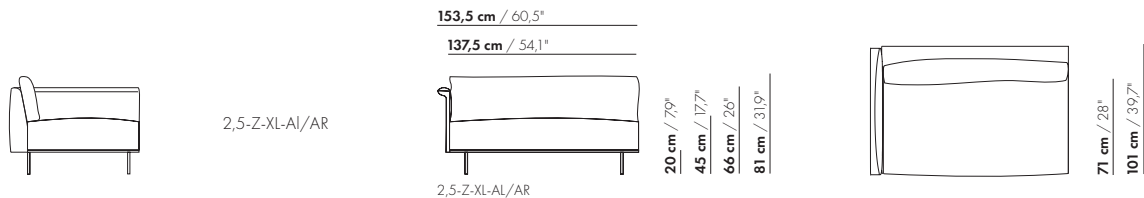
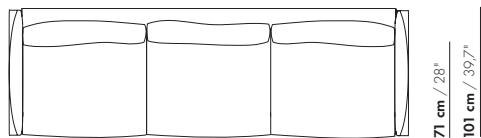
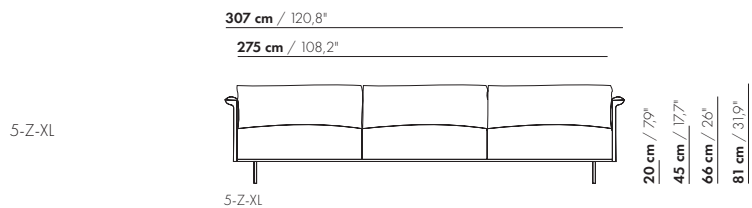
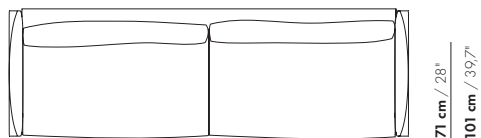
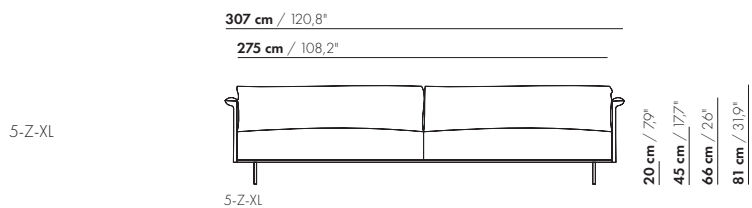

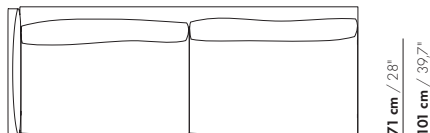
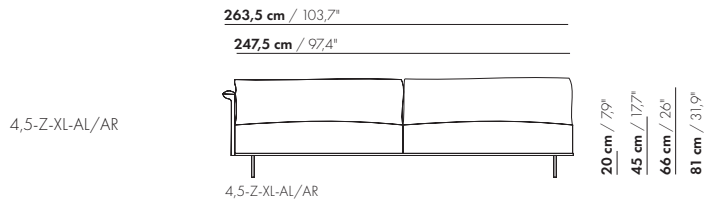
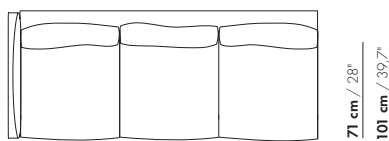
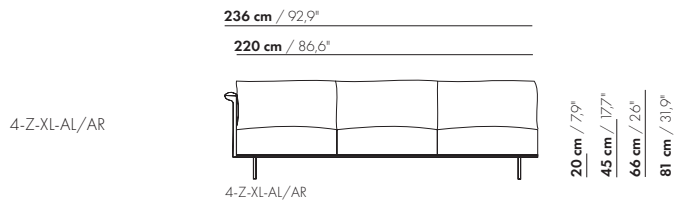
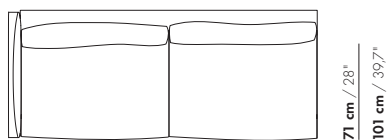
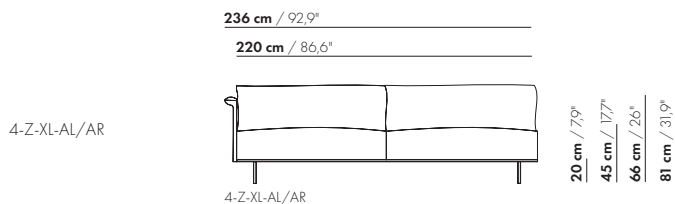
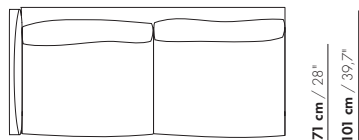
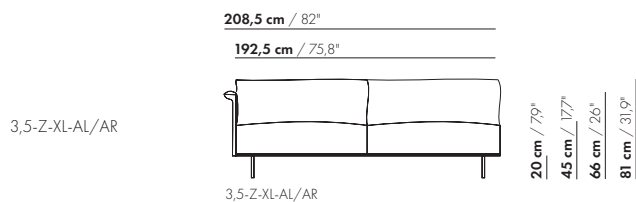

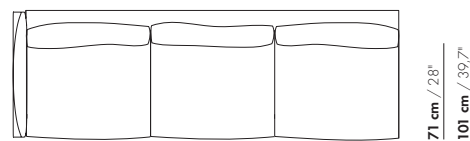
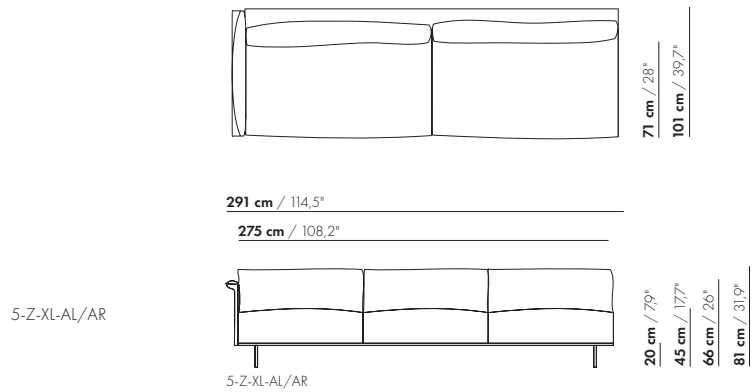
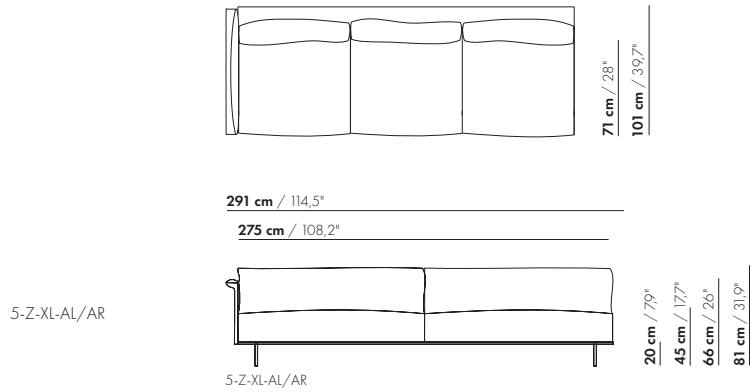
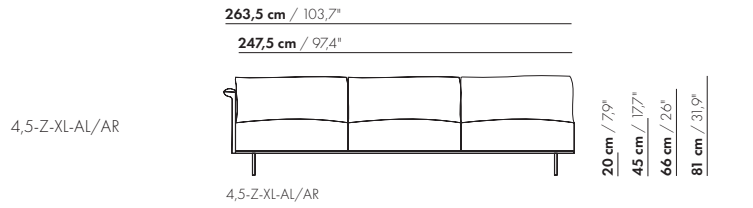

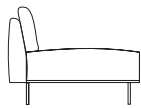

1,5-Z-XL-ZA

82,5 cm / 32,5"

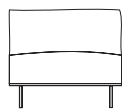

1,5-Z-XL-ZA

20 cm / 7,9"  
45 cm / 17,7"  
81 cm / 31,9"

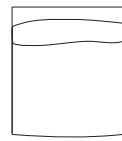

71 cm / 28"  
101 cm / 39,7"

2-Z-XL-ZA

110 cm / 43,3"



2-Z-XL-ZA

20 cm / 7,9"  
45 cm / 17,7"  
81 cm / 31,9"

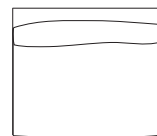

71 cm / 28"  
101 cm / 39,7"

2,5-Z-XL-ZA

137,5 cm / 54,1"

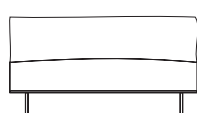

2,5-Z-XL-ZA

20 cm / 7,9"  
45 cm / 17,7"  
81 cm / 31,9"

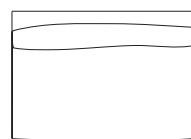

71 cm / 28"  
101 cm / 39,7"

2,5-Z-XL-ZA

137,5 cm / 54,1"

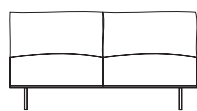

2,5-Z-XL-ZA

20 cm / 7,9"  
45 cm / 17,7"  
81 cm / 31,9"

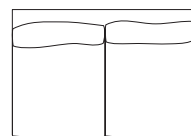

71 cm / 28"  
101 cm / 39,7"

3-Z-XL-ZA

165 cm / 65"

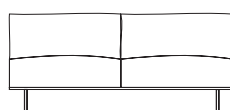

3-Z-XL-ZA

20 cm / 7,9"  
45 cm / 17,7"  
81 cm / 31,9"

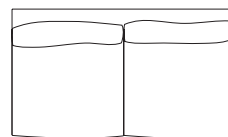

71 cm / 28"  
101 cm / 39,7"

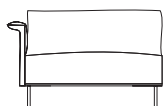

3,5-Z-D-XL-PL/PR

265,5 cm / 104,5"

176,5 cm / 69,5"

55 cm / 21,6"

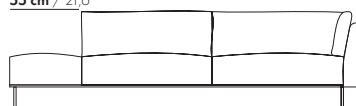

3,5-Z-D-XL-PL/PR

20 cm / 7,9"  
45 cm / 17,7"  
66 cm / 26"  
81 cm / 31,9"

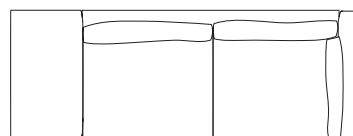

71 cm / 28"  
101 cm / 39,7"



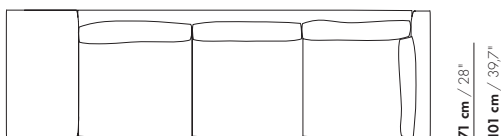
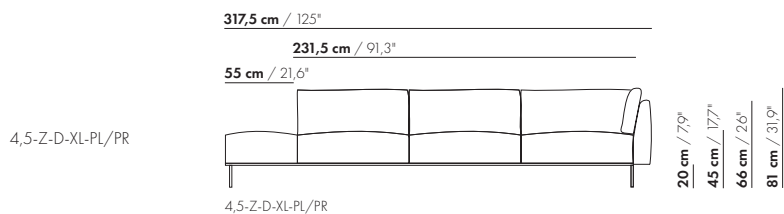
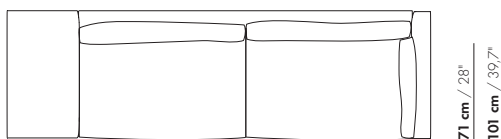
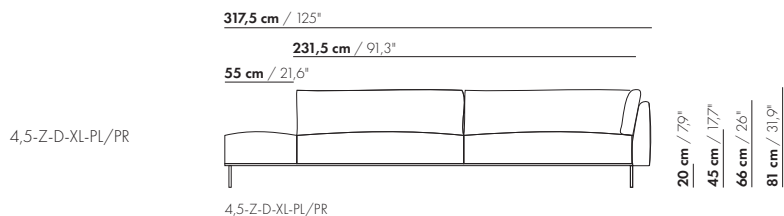
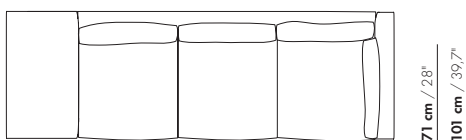
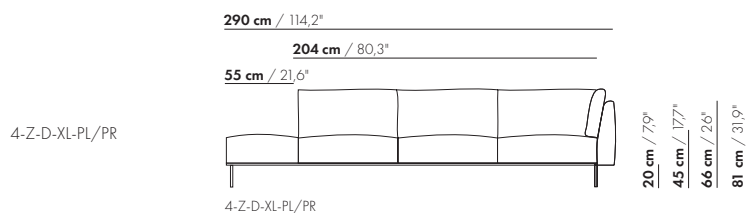
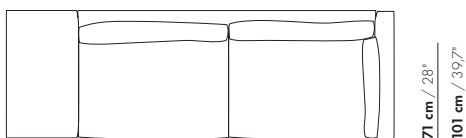
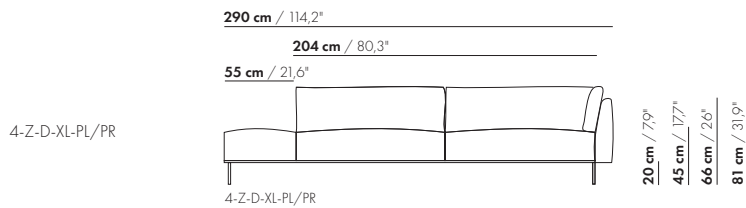

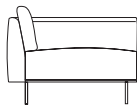

3-Z-H-XL-AL/AR

195 cm / 76,7"

149 cm / 58,6"

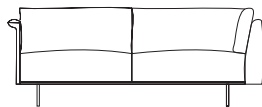

3-Z-H-XL-AL/AR

20 cm / 7,9"

45 cm / 17,7"

66 cm / 26"

81 cm / 31,9"

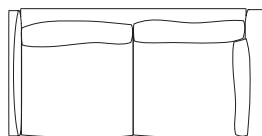

71 cm / 28"

101 cm / 39,7"

222,5 cm / 87,6"

176,5 cm / 69,5"

3,5-Z-H-XL-AL/AR

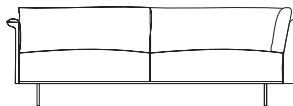

3,5-Z-H-XL-AL/AR

20 cm / 7,9"

45 cm / 17,7"

66 cm / 26"

81 cm / 31,9"

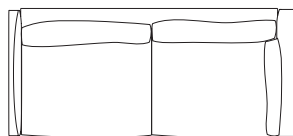

71 cm / 28"

101 cm / 39,7"

250 cm / 98,4"

204 cm / 80,3"

4-Z-H-XL-AL/AR

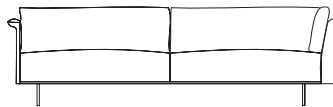

4-Z-H-XL-AL/AR

20 cm / 7,9"

45 cm / 17,7"

66 cm / 26"

81 cm / 31,9"

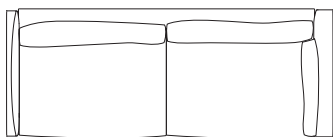

71 cm / 28"

101 cm / 39,7"

250 cm / 98,4"

204 cm / 80,3"

4-Z-H-XL-AL/AR

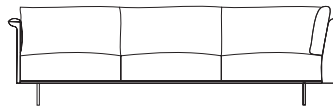

4-Z-H-XL-AL/AR

20 cm / 7,9"

45 cm / 17,7"

66 cm / 26"

81 cm / 31,9"

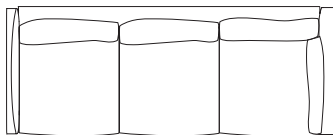

71 cm / 28"

101 cm / 39,7"

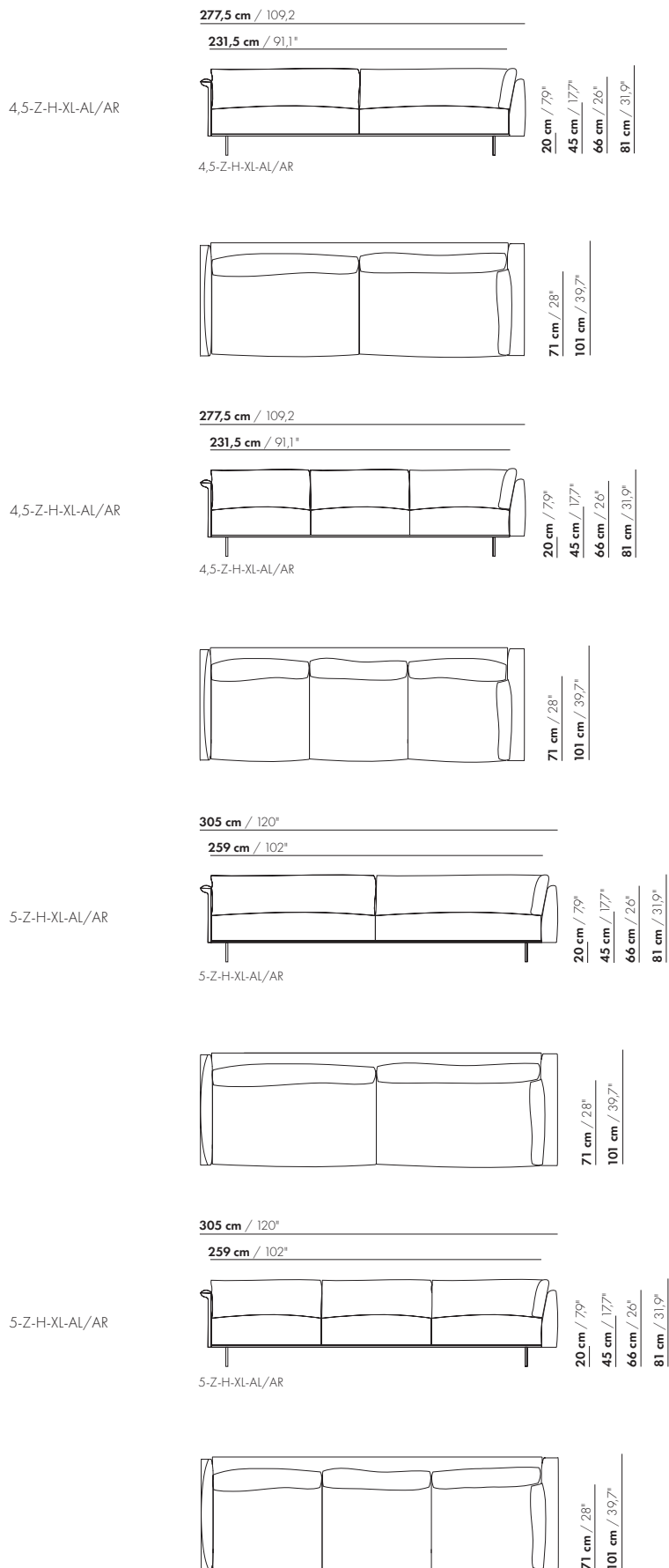

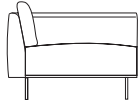

3-Z-H-XL-L/R-E

179 cm / 70,9°  
149 cm / 58,6°

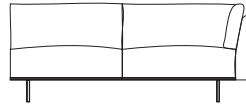

3-Z-H-XL-L/R-E

20 cm / 7,9°  
45 cm / 17,7°  
66 cm / 26°  
81 cm / 31,9°

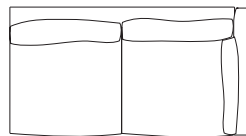

71 cm / 28°  
101 cm / 39,7°

206,5 cm / 81,3°  
176,5 cm / 69,5°

3,5-Z-H-XL-L/R-E

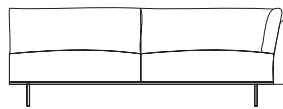

3,5-Z-H-XL-L/R-E

20 cm / 7,9°  
45 cm / 17,7°  
66 cm / 26°  
81 cm / 31,9°

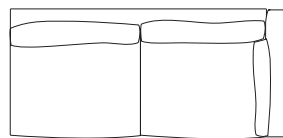

71 cm / 28°  
101 cm / 39,7°

4-Z-H-XL-L/R-E

234 cm / 92,1°  
204 cm / 80,3°

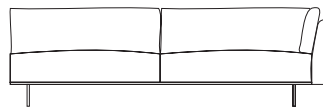

4-Z-H-XL-L/R-E

20 cm / 7,9°  
45 cm / 17,7°  
66 cm / 26°  
81 cm / 31,9°

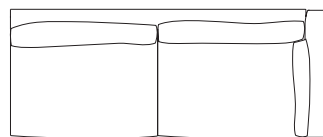

71 cm / 28°  
101 cm / 39,7°

4-Z-H-XL-L/R-E

234 cm / 92,1°  
204 cm / 80,3°

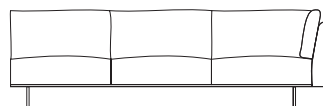

4-Z-H-XL-L/R-E

20 cm / 7,9°  
45 cm / 17,7°  
66 cm / 26°  
81 cm / 31,9°

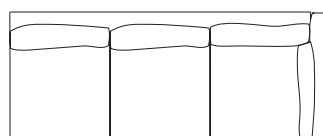

71 cm / 28°  
101 cm / 39,7°

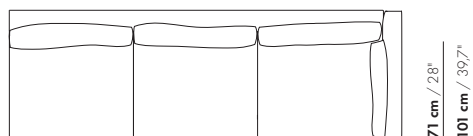
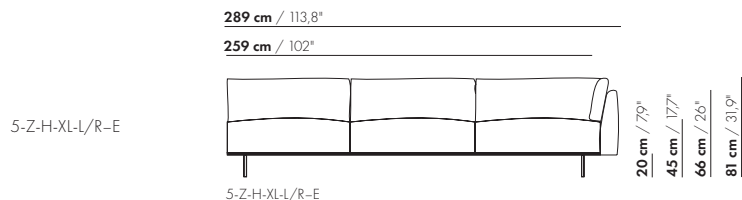
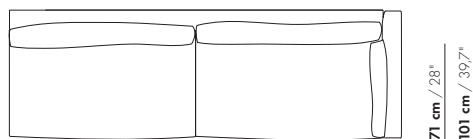
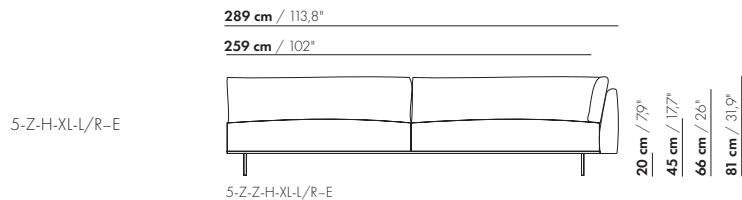
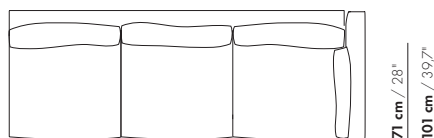
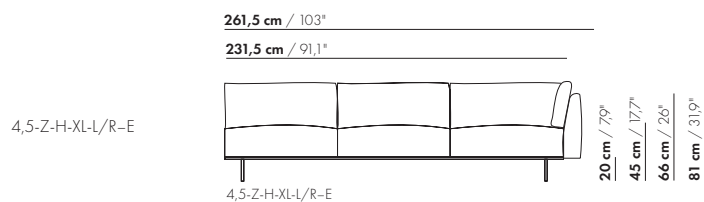
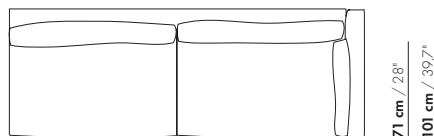
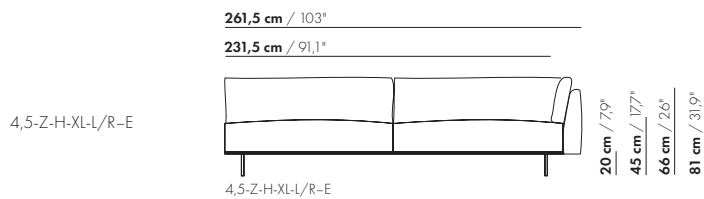

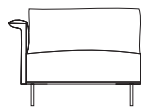

CHL 104x146

**104 cm / 41"**  
**88 cm / 34,6"**

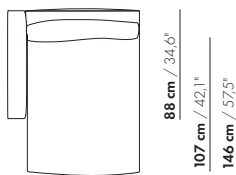

CHL 104x146

**88 cm / 34,6"**

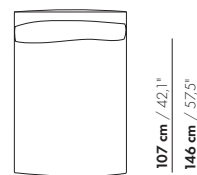

CHL 104x146-E

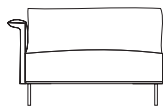

CHL-XL 117x190

**117 cm / 46"**  
**101 cm / 39,7"**

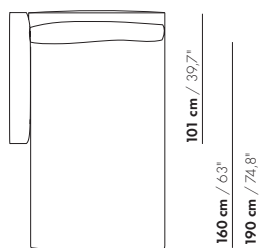

CHL-XL 117x190

**101 cm / 39,7"**

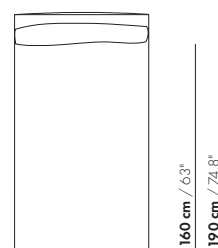

CHL-XL 117x190-E



P-85X55

**55 cm / 21,6"**  
**20 cm / 7,9"**  
**45 cm / 17,7"**

P-85X55

**85 cm / 33,5"**



P-85X85

**85 cm / 33,5"**  
**20 cm / 7,9"**  
**45 cm / 17,7"**

P-85X85

**85 cm / 33,5"**



PXL-98X60

**60 cm / 23,6"**  
**20 cm / 7,9"**  
**45 cm / 17,7"**

PXL-98X60

**98 cm / 38,6"**



PXL-98X98

**98 cm / 38,6"**  
**20 cm / 7,9"**  
**45 cm / 17,7"**

PXL-98X98

**98 cm / 38,6"**



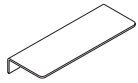

ARM TABLE

25 cm / 9,8"

76 cm / 29,9"

76 cm / 29,9"

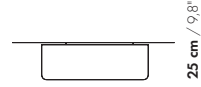

ARM TABLE L/R

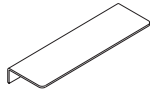

25 cm / 9,8"

89 cm / 35"

89 cm / 35"

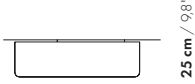

ARM TABLE XL L/R



25 cm / 9,8"

76 cm / 29,9"

76 cm / 29,9"

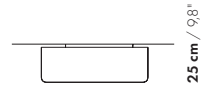
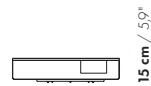
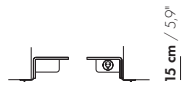

ARM TABLE L/R - POWER/QI

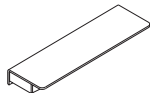

25 cm / 9,8"

89 cm / 35"

89 cm / 35"

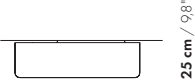
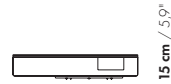
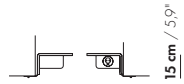

ARM TABLE XL L/R - POWER/QI

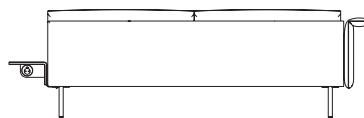
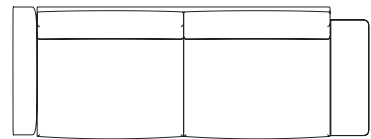
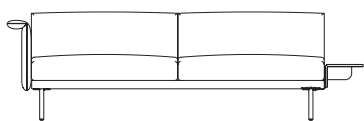

SIDE TABLE

34 cm / 13,4"

26 cm / 10,2"

34 cm / 13,4"



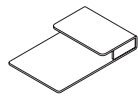

DORMEUSE TABLE

54 cm / 21,2"

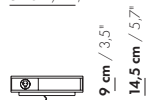

DORMEUSE TABLE L/R

83 cm / 32,6"

36,5 cm / 14,3"

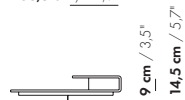

83 cm / 32,6"

36,5 cm / 14,3"

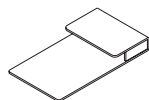

54 cm / 21,2"

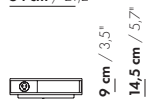

DORMEUSE TABLE XL L/R

96 cm / 37,8"

36,5 cm / 14,3"

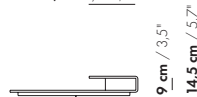

96 cm / 37,8"

36,5 cm / 14,3"

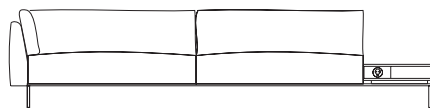
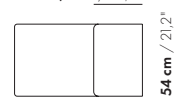

DORMEUSE TABLE R

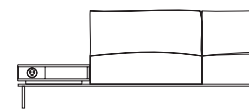

DORMEUSE TABLE L

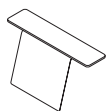

CONSOLE TABLE

75 cm / 29,5"

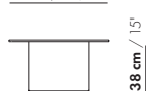

CONSOLE TABLE

28 cm / 11"

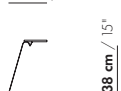

75 cm / 29,5"

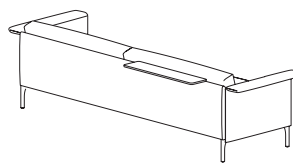
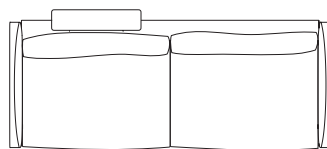
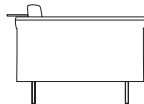

HEADREST

66 cm / 26"

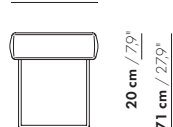

HEADREST SOFT & EXTRA SOFT

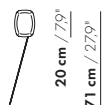

66 cm / 26"



66 cm / 26"

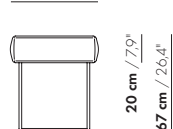

HEADREST MEDIUM & FIRM



66 cm / 26"

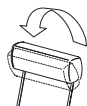

35°





STANDARD  
STITCHPATTERN LEATHER

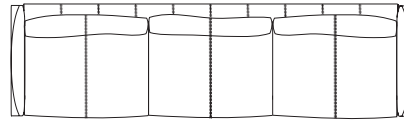
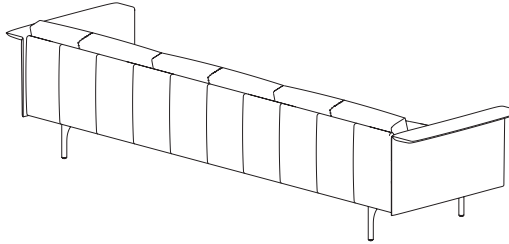
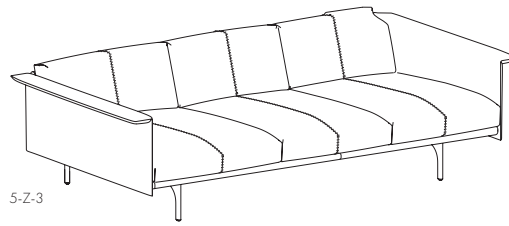

STITCHPATTERN LEATHER  
EXTRA SEAMS LEATHER  
RANCHO L40

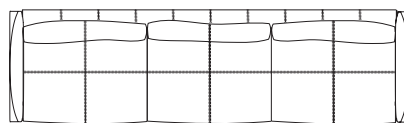
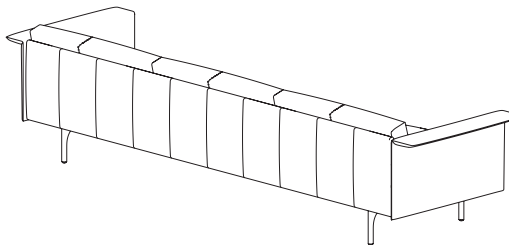
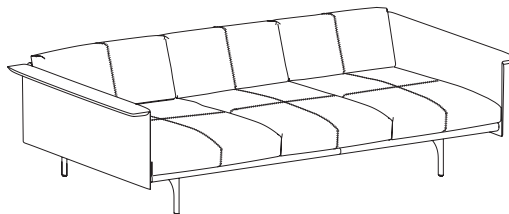

STANDARD  
STITCHPATTERN LEATHER

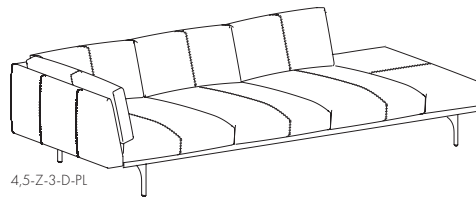

4.5-Z-3-D-PL

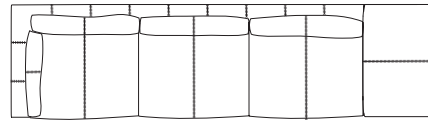
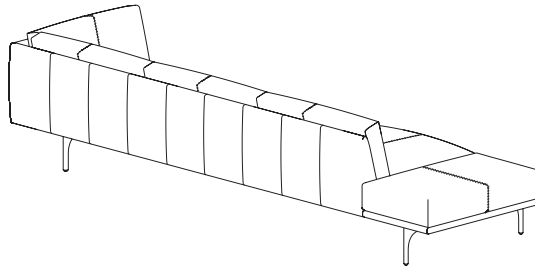

STITCHPATTERN LEATHER  
EXTRA SEAMS LEATHER  
RANCHO L40

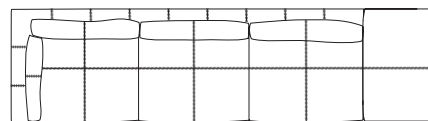
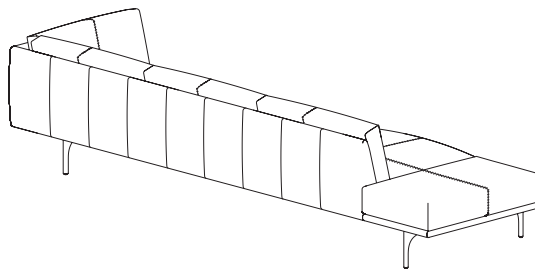
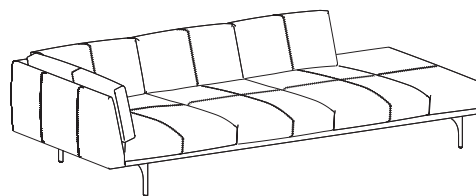

STANDARD  
STITCHPATTERN LEATHER

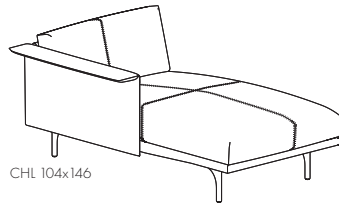

CHL 104x146

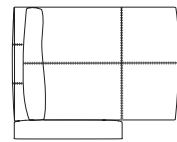
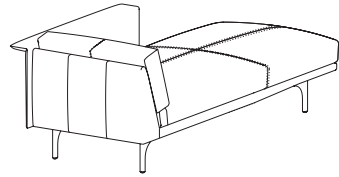

STITCHPATTERN LEATHER  
EXTRA SEAMS LEATHER  
RANCHO L40

