

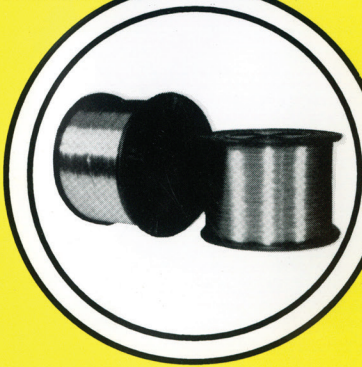

**MSI BINDERY PARTS**

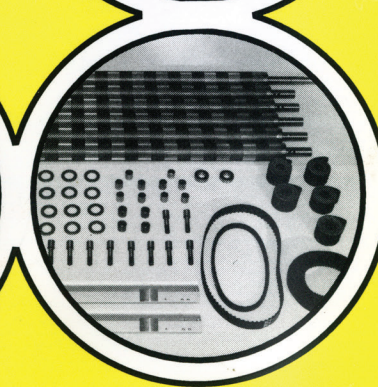
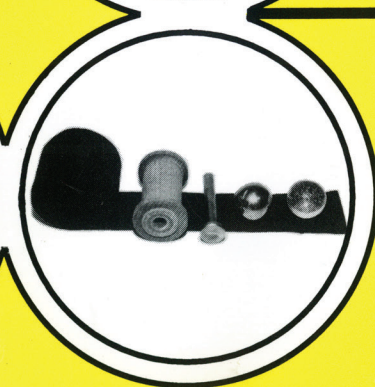
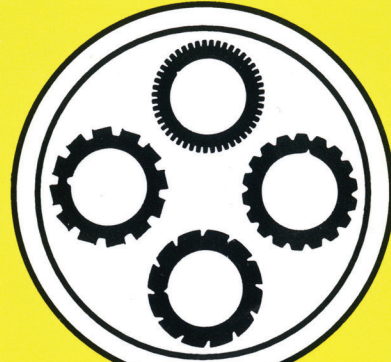

**REPLACEMENT PARTS  
AND  
BINDERY SUPPLIES**

---

## **Repair Services available through MSI ...**

- **Bindery Equipment Repair**
- **Folding Machine Preventative Maintenance**
- **Operator Instruction**

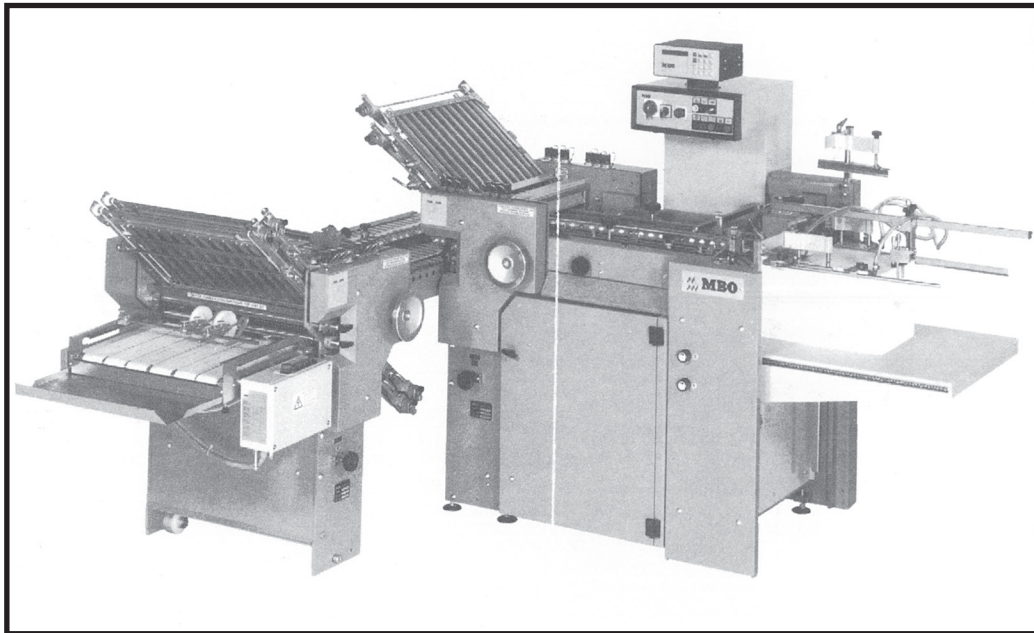

**You'll receive prompt, courteous service and have access to expert knowledge with over 40 years experience in the industry.**

- **Factory trained Baumfolder, Stahl, MBO model folders**
- **Specializing in Electrical as well as mechanical troubleshooting**

**For more information, service rates or to schedule an appointment**

**Call Mike @ (914) 475-4397**

---

# **WELCOME . . .**

*. . . to MSI's PARTS & SUPPLIES CATALOG – THE SOURCE for all of your folder and bindery supply needs.*

*For those of you familiar with MSI, we would like to extend a heartfelt “Thank You” for your continued support. We greatly appreciate your business and value the friendships we have developed over the years.*

*For those of you experiencing MSI for the first time, we extend a warm welcome. As a member of the MSI family, you will be treated to exceptional service, knowledgeable, friendly staff and competitive prices.*

*We strive to fulfill our founding philosophy – to provide parts and accessories at affordable prices, along with customer service reminiscent of days gone by. Quality and caring are the backbone of MSI. Give us a try; you won't be disappointed.*

## **Who we are . . .**

With over 20 years experience in the industry, our staff has held positions such as Product Specialist (including electronics) for Baumfolder Corporation and Heidelberg USA, as well as Senior Service Technician with MBO America. We also have several years of “hands on” experience as a folder operator, bindery supervisor and in direct marketing. This combined expertise has enabled customers to access a wealth of information and make purchases at very competitive prices: you can rest assured that your equipment is in good hands with MSI!

# TABLE OF CONTENTS

## REPAIR SERVICES OFFERED .....IFC

**BAUMFOLDER\*** .....3, 4, 5  
Replacement Parts

**MBO\* & STAHL\*** .....6  
Replacement Parts

**MBO\* & STAHL\*** .....7  
Slittershaft Accessories

**MBO\*** .....8  
Perfs, Scores, Slitters

**STAHL\*** .....9  
Perfs, Scores, Slitters

**FOLDER REBUILD KITS** .....10  
Kits, Rollers

**ELECTRICAL** .....11  
Plugs/Switches/Cable

**COUNTERS** .....12  
Batch, Total Count, Memory

**CUTTER** .....13  
Replacement Parts & Supplies

**ACCESSORIES, SUPPLIES** .....14

**BINDERY SUPPLIES** .....15  
Lubricants, Wrenches

**DRILLS, WET SCORES** .....16  
Systems & Replacement Parts

**STITCHING WIRE** .....17

**STITCHERS, HEADS** .....18, 19  
Replacement Parts

**PUMPS & FILTERS** .....20

**GLUE SYSTEMS** .....IBC  
Systems & Replacement Parts

\*Registered trademarks of Baumfolder, MBO & Stahl

## ORDER INFORMATION

Ordering is easy with MSI. Just call, fax, e-mail or mail us your order and we'll take it from there.

**Phone:** (845) 897-2688  
**E-mail:** folderparts@gmail.com  
**US Mail:** MSI Bindery Service  
PO Box 415  
Hopewell Junction, NY 12533  
**Website:** www.msibinderyparts.com  
**Shipping:** 15 Hosner Mountain Road  
Hopewell Junction, NY 12533

## AUTHORIZED DEALERS FOR:

|                        |                 |
|------------------------|-----------------|
| ANDERSON BANDERS       | PAFRA           |
| BAUMFOLDER CORP.       | PROFOLD         |
| DELUXE/BOSTITCH        | ROTO-CREASE     |
| JAYHAWK PLASTICS, INC. | STIX UNLIMITED  |
| MBO AMERICA            | TACONIC WIRE    |
| MOLL GROUP             | VIJUK EQUIPMENT |
| OLDEN ENTERPRISES      |                 |

## REPLACEMENT PARTS & SUPPLIES FOR:

|                    |              |
|--------------------|--------------|
| CHALLENGE          | NYGREN DAHLY |
| CLEVELAND          | O&M          |
| DEXTER-LAWSON MFR. | PERMALUBE    |
| HOHNER             | ROBATECH     |
| IRAM               | ROSBACK      |
| MBO                | SPINNET      |
| McCAIN             | STAHL        |
| MULLER MARTINI     | SULBY        |

## WHY CHOOSE MSI?

- ✓ Personalized friendly service.
- ✓ Most orders shipped same day via UPS or Federal Express.
- ✓ All major credit cards accepted.
- ✓ The MSI Guarantee! We want you to be happy. If you're not satisfied with the quality of any product, simply return it for credit or refund.

## 714 TABLETOP PARTS

### ATTENTION BAUM 714 TABLETOP OWNERS!

Full Line of Belts, Gears, Rollers, & Electrical Parts Available

| Mfr. #        | Description                        |
|---------------|------------------------------------|
| • Baum #50498 | Orange sheet detector tabs         |
| • Baum #50080 | Sucker wheel tires                 |
| • Baum #45290 | Retarder tires                     |
| • Baum #06402 | Pullout tires (for slitter shafts) |
| • Baum #48429 | Feed tire                          |

### TUNE UP KITS

**714 Air Feed** - Includes 3 sucker tires, 1 orange sheet detector tab, 4 pullout tires, and roller rejuvenator.  
#262-741-01-00

**714 Friction Feed** - Includes 2 feed tires, 2 retarder tires, 4 pullout tires and roller rejuvenator.  
#262-742-01-00

**714 Complete Rebuild Kits** - Includes all necessary parts to make your folder run like new again! Choose from Rebuild Kits with urethane or combination rollers.

## PERFS • SCORES • SLITTERS

### PERFORATOR BLADES

#### 7/8" DIAMETER SLITTER SHAFT

|   |  |
|---|--|
| 6 Tooth Perforator<br>P/N 07618<br>TPI-1    | 24 Tooth Perforator<br>P/N 07619<br>TPI-4  |
| 12 Tooth Perforator<br>P/N 06605<br>TPI-2   | 31 Tooth Perforator<br>P/N 06798<br>TPI-5  |
| 15 Tooth Perforator<br>P/N 07895<br>TPI-2.5 | 41 Tooth Perforator<br>P/N 07791<br>TPI-7  |
| 18 Tooth Perforator<br>P/N 07896<br>TPI-3   | 64 Tooth Perforator<br>P/N 11962<br>TPI-11 |

#### 1-1/8" DIAMETER SLITTER SHAFT

|  |  |
|--|--|
| 15 Tooth Perforator<br>P/N 10362<br>Solid<br>TPI-2 | 30 Tooth Perforator<br>P/N 51941<br>Split<br>TPI-4 |
| 15 Tooth Perforator<br>P/N 51940<br>Split<br>TPI-2 | 50 Tooth Perforator<br>P/N 10364<br>TPI-7          |
| 30 Tooth Perforator<br>P/N 10363<br>Solid<br>TPI-4 | 80 Tooth Perforator<br>P/N 80-3P<br>3-Hole         |

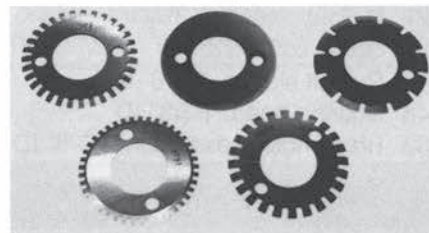

### SCORES

| Mfr. #      | Description          |
|-------------|----------------------|
| Baum #06379 | Thin score, 7/8" ID  |
| Baum #06380 | Thick score, 7/8" ID |
| Baum #10352 | Score, 1-3/8" ID     |
| Baum #10353 | Score, 1-3/8" ID     |

### SLITTERS

| Mfr. #   | Description                         |
|--|-------------------------------------|
| Baum #06378  | Slitter, RH, 7/8" ID                |
| Baum #06804  | Slitter, LH, 7/8" ID                |
| Baum #15573  | Slitter, LH - countersunk flat side |
| Baum #15574  | Slitter, RH - countersunk flat side |
| Baum #51943  | Slitter, split, 1-3/8" ID           |
| Baum #93209  | Slitter, solid w/ 3 hole, 1-3/8" ID |
| Double Countersunk Slitter - <i>eliminates the need for left and right hand blades</i> |                                     |

\*Registered trademark of Baumfolder Corp.

# BAUMFOLDER\* Replacement Parts

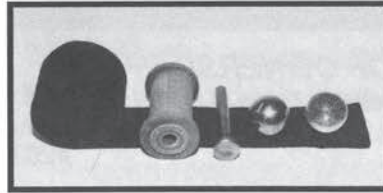
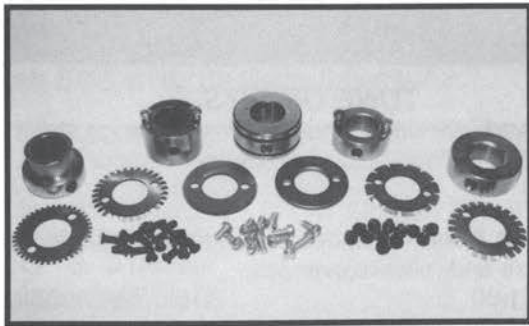

Register Kit



## BLADE HOLDERS, COLLARS, DIES

| Mfr. #      | Description                     |
|-------------|---------------------------------|
| Baum #06411 | Blade holder, 7/8" ID x 5/8" w  |
| Baum #06412 | Retaining collar                |
| Baum #06413 | Blade holder, 7/8" ID x 1" w    |
| Baum #06799 | Perforator die block, 7/8" ID   |
| Baum #06997 | Pullout sleeve, 7/8" ID         |
| Baum #07780 | Score collar, 7/8" ID           |
| Baum #10346 | Pullout sleeve, 1-3/8" ID       |
| Baum #51948 | Scoring head, 1-3/8" ID         |
| Baum #52083 | Blade holder assembly 1-3/8" ID |

*Many Others Available!*

## GEARS (partial listing)

Mfr. # Description

### ROLLER GEARS

|             |  |
|-------------|--|
| Baum #06077 | Spur gear, 21T (for Mkl, series 200, 600, 700) |
| Baum #09544 | Spur gear 18T (for Mkl, series 400 & 500)      |
| Baum #52677 | Helical gear, RH (Liberty and newer), 13T      |
| Baum #52678 | Helical gear, LH (Liberty and newer), 13T      |

### DRIVE GEARS

|             |  |
|-------------|--|
| Baum #06318 | Spur gear, 36T (for Mkl)                   |
| Baum #11607 | Spur gear, 18T (for Mkl, series 400 & 500) |
| Baum #14725 | Spur gear, 56T (for series 400 & 500)      |

### CROSS CARRIER GEARS

|             |  |
|-------------|--|
| Baum #14956 | Drive gear, 21T (for Mkl, 400 & 500 ser.)  |
| Baum #14957 | Sheave gear, 18T (for Mkl, 400 & 500 ser.) |
| Baum #29953 | Drive gear 32T (for Mkl, 200, 600, 700)    |
| Baum #29954 | Drive gear, 26T (for Mkl, 200, 600, 700)   |

## GUIDESHoes & SHEET HOLDDOWNS

Mfr. # Description

|             |                           |
|-------------|---------------------------|
| Baum #15623 | Stacker holddown assembly |
| Baum #15625 | Guideshoe assembly (Mkl)  |
| Baum #15694 | Guideshoe assembly (Mkl)  |
| Baum #19083 | Tuck-in Shoe assembly     |

*Many Others Available!*

\*Registered trademark of Baumfolder Corp.

## MARBLES

| Mfr. #      | Description | Mfr. #      | Description |
|-------------|-------------|-------------|-------------|
| Baum #21123 | Steel, 5/8" | Baum #21128 | Glass, 5/8" |
| Baum #21124 | Steel, 3/4" | Baum #21129 | Glass, 3/4" |
| Baum #21125 | Steel, 1"   | Baum #21130 | Glass, 1"   |

## REGISTER KITS

*Save money* by purchasing these commonly used parts in one complete kit:

- Kit includes:
- REGISTER TAPES
  - TAPE SPOOLS & STUDS
  - 6 EACH OF GLASS & STEEL MARBLES

*Please call for price.*

## REGISTER TAPES

| Mfr. #      | Description | Mfr. #      | Description  |
|-------------|-------------|-------------|--------------|
| Baum #20924 | 1 x 61      | Baum #20930 | 1-1/2 x 97"  |
| Baum #20925 | 1 x 73"     | Baum #20931 | 1-1/2 x 105" |
| Baum #20926 | 1 x 97"     | Baum #21679 | 1-1/2 x 73"  |
| Baum #20929 | 1-1/2" x 61 | Baum #23909 | 1-1/2 x 102" |

*Many Others Available!*

## TAPE SPOOLS & STUDS

| Mfr. #      | Description  | Mfr. #      | Description       |
|-------------|--------------|-------------|-------------------|
| Baum #06232 | 1" width     | Baum #07643 | Spool stud, long  |
| Baum #06902 | 1-1/2" width | Baum #06231 | Spool stud, short |



**WORN TAPE SPOOLS & STUDS CAN WEAR OUT REGISTER TAPES. REPLACE ALL THREE AT THE SAME TIME FOR OPTIMUM PERFORMANCE. TO PREVENT PREMATURE WEAR, USE THE LEAST AMOUNT OF PRESSURE POSSIBLE WHEN TIGHTENING THE TAPE SPOOLS.**

# Replacement Parts **BAUMFOLDER\***

## SCREWS

| Mfr. #      | Description  |
|-------------|--|
| Baum #20312 | Fillister head screw, for score blades                 |
| Baum #20438 | Brass tip set screw, use with slittershaft accessories |
| Baum #07728 | Flathead screw, for slitler blades                     |

## STRIPPERS

| Mfr. #      | Description  |
|-------------|--|
| Baum #06434 | Edge stripper RH-Assembly #15627   |
| Baum #06435 | Edge stripper LH-Assembly #15628   |
| Baum #06438 | Slotted perforator stripper  |
| Baum #15624 | Perforator stripper assembly: (includes stripper, clamp, screw & thumbscrew) |
| Baum #28613 | Brass center stripper, 1/4"w   |
| Baum #28614 | Brass center stripper, 1/8"w   |
| N/A         | Stripper (metal loop)  |

*Many Others Available!*

## RUBBER TIRES

| Mfr. #      | Description                                 |
|-------------|---|
| Baum #01682 | Caliper draw roll bands, 7/8" ID            |
| Baum #06402 | Pullout tire, 7/8" ID                       |
| Baum #07781 | Scoring rubber, 7/8" ID                     |
| Baum #10306 | Retarder tire, 1"wx7/8" IDx1-3/4" OD        |
| Baum #10347 | Pullout tire, 1-3/8" ID                     |
| Baum #10350 | Scoring rubber, 1-3/8" ID                   |
| Baum #12718 | Retarder tire, lower, 5/8"wx1" IDx1-1/2" OD |
| Baum #13266 | Friction feed tire, upper                   |
| Baum #14993 | Retarder tire, lower, 1"wx1" IDx1-1/2 OD    |

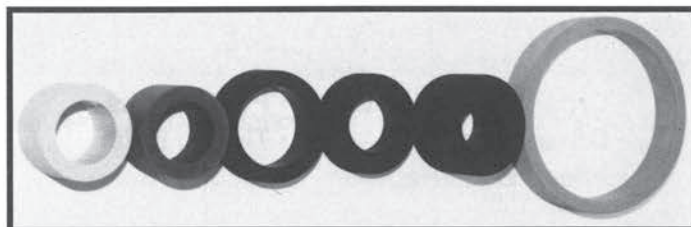

## DEXTER • FALTEX • PROFOLD • VIJUK\*

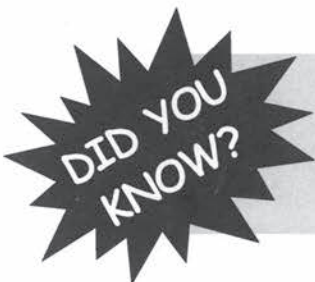

MSI sells replacement parts for **Vijuk** and **Faltex** folding machines, as well as many of the hard-to-find parts for **Dexter-Cleveland** folders.

***Belts...Fold Rollers...Gears...Pulleys...Slittershafts...and MORE!***

## PROFOLD REPLACEMENT PARTS

| Mfr. # | Description               |
|--------|---------------------------|
| 109624 | Stationary roller - TF/BF |
| 109696 | Feed Wheel Tire - TF      |
| 138056 | Feed Wheel Tire - BF      |
| 3342   | Pullout Tire              |
| 3343   | Pullout Sleeve            |

| Mfr. # | Description                |
|--------|----------------------------|
| 3344   | Pullout Tire Assembly      |
| N/A    | Perf Blades, 24T, 31T, 41T |
| N/A    | Slitter Blades, LH/RH      |
| 4520   | Blade Holder               |
| 138343 | Scoring Collar             |

***Most Replacement Parts Available***

\*Registered trademarks of Baumfolder Corp., Dexter, Faltex, Profold & Vijuk

To Order Call: 845-897-2688

e-mail: folderparts@gmail.com

# MBO\* & STAHL\* Replacement Parts

## Everything you need for MBO & STAHL Folders!

- Belts
- Cable
- Idler Pulleys
- Pulleys
- Shafts
- Smoothers
- Bearings
- Connectors
- Lock Handles
- Rebuild Kits
- Slittershafts
- Tapes
- Contactors
- Electrical
- Pumps
- Rollers
- Side Guides
- Vacuum Wheels

### PULLEYS

#### VARIABLE SPEED, SPRING & MECHANICAL PULLEYS

Available from MSI at significant savings over the manufacturer's price. (Please have motorshaft size available.)

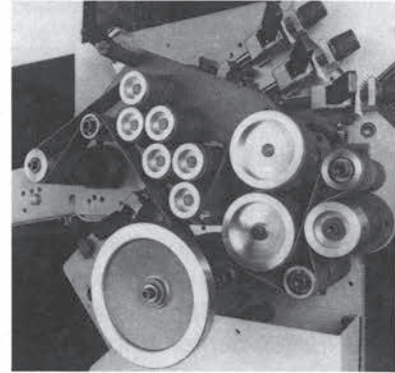

### MBO BELTS and TAPES (partial list)

- Cross Carrier Belts
- Poly V Belts
- Drive Belts
- Timing Belts
- Infeed Belts/Register
- Stacker Belts

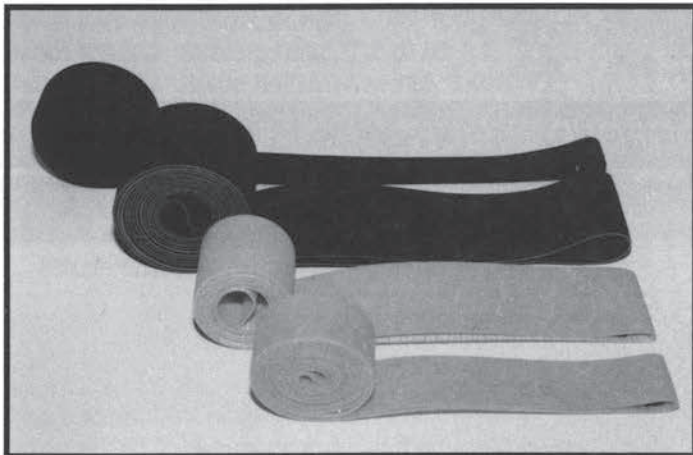

### MARBLES & MARBLE CUPS

| Mfr. #          | Description              |
|-----------------|--------------------------|
| MBO20DIA-P      | 20mm Plastic - MBO       |
| MBO20DIA-S      | 20mm Steel - MBO         |
| 200-634-0200    | 24mm Plastic - Stahl     |
| 200-132-0500    | 24 mm Steel - Stahl      |
| MBO25DIA-P      | 25mm Plastic - MBO       |
| MBO25 DIA-S     | 25mm Steel - MBO         |
| 200-634-0300    | 35mm Plastic - Stahl     |
| 200-132-0600    | 35mm Steel - Stahl       |
| 206-773-0200    | 24mm Marble Cup - Stahl  |
| MBO-50-7200-220 | 25mm Adj. Ball Cub - MBO |
| 206-774-0200    | 35mm Marble Cup - Stahl  |

### STAHL STRIPPER ASSEMBLIES

| MSI #    | Description  |
|----------|--|
| PF35     | Perf Stripper, 35mm shaft  |
| PF25     | Perf Stripper, 25mm shaft  |
| CT00     | Center Trim Stripper, 1/8, 1/4, 3/8, 1/2" widths                   |
| ET-TD    | Edge Trim Stripper, TD Series                                      |
| CT-TF    | Center Trim Stripper, TF Series, 1/8, 1/4, 3/8, 1/2" widths        |
| ET-TF/TC | Edge Trim Stripper, SOM TF & TC Series                             |
| CT-SOM   | Center Trim Stripper, SOM/parallel only, 1/8, 1/4, 3/8 1/2" widths |
| CT-B20   | Center Trim Stripper, Stahl USA, B20, 1/4" width                   |

### MBO STRIPPER ASSEMBLIES

| MSI #       | Description  |
|-------------|--|
| ET-49       | Edge Trim Stripper, T49/55                           |
| EDT-49      | Edge Trim Deflector, T49/55                          |
| CT-49       | Center Trim Stripper, T49/55, 2mm, 5mm & 10mm widths |
| PS-49       | Perf Stripper, T49/55                                |
| ET-23/26/30 | Edge Trim Stripper, B23/B26/B30                      |
| PS-23/26/30 | Perf Stripper, B23/B26/B30                           |
| CT-23/26/30 | Center Trim Stripper, B23/B26/B30                    |

- All Parts Available Individually or as an Assembly
- Smoother Bars Available!

\*Registered trademarks of MBO & Stahl



# Slittershaft Accessories **MBO\*** & **STAHL\***

## ROTOCREASE ACCESSORIES

FOR BAUM, STAHL & MBO FOLDERS:

|        |                                   |
|--------|-----------------------------------|
| RC00   | Register wheel set                |
| RC022  | Scoring wheel set, .022 thickness |
| RC028  | Scoring wheel set, .028 thickness |
| RC032  | Scoring wheel set, .032 thickness |
| RCSB   | Slitter blade                     |
| RCST   | Stripper holder and finger        |
| RCS-12 | Perf blade set - 12 TPI           |
| RC12T  | Perf blade - 12 TPI               |
| RCBT   | Perf blade - 8 TPI                |
| RCOR   | O'ring                            |

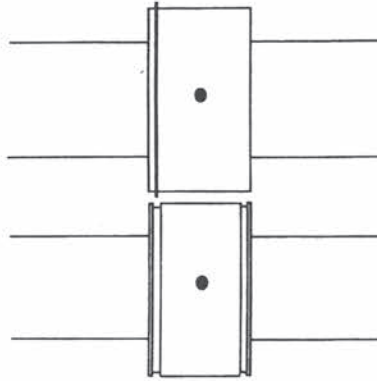

## LETTERPRESS QUALITY SCORES FOR STAHL & MBO FOLDERS

Minimize cracking with the Dyna Score. Letterpress quality scores available in 2 sizes: 30mm and 35mm sets. Choose .029 thickness for thick stocks and .022 for light weight cover stock and 100 lb. offset. All score sets are sold with a money-back guarantee!

**Replacement Parts Available!**

## MBO BLADE HOLDERS, DIE BLOCKS & DIE COLLARS (partial listing)

| Mfr. #         | Description                             | Slittershaft Size |
|----------------|---|-------------------|
| B01533900      | Transport Collar, rubber/steel          | 35mm              |
| B105339010     | Transport Collar, steel, MBO T47/49     | 30mm              |
| B01553900/01   | Blade Holder                            | 35mm              |
| B01553901/02   | Blade Holder/center trim                | 35mm              |
| B105539010/020 | Blade Holder, MBO T47/49                | 30mm              |
| B105539310/330 | Blade Holder/center trim, MBO T47/49    | 30mm              |
| B35-446        | Blade Holder/center trim 1", MBO T47/49 | 30mm              |
| B205539010     | Die Block, MBO T47/49                   | 30mm              |
| B50210010      | Die Block                               | 35mm              |

## MBO & STAHL TRIM RINGS

| Mfr. # | Description                  | Slittershaft Size |
|--------|------------------------------|-------------------|
| 35-465 | 1/4", Stahl B14/T36          | 26mm              |
| 35-454 | 1/4" with groove             | 30mm              |
| 35-452 | 3/8"                         | 30mm              |
| 35-440 | 1/4" with groove, MBO T47/49 | 35mm              |
| 35-439 | 3/8", MBO T47/49             | 35mm              |
| 35-438 | 1/4", MBO T47/49             | 35mm              |
| 35-420 | 1/4" with groove             | 40mm              |
| 35-419 | 3/8"                         | 40mm              |
| 35-418 | 1/4"                         | 40mm              |

## STAHL TRIM SPACERS

| Mfr. # | Description  | Slittershaft Size |
|--------|--------------|-------------------|
| 35-409 | Spacer 1/8"  | 40mm x 0.5        |
| 35-410 | Spacer 3/16" | 40mm x 0.5        |
| 35-411 | Spacer 1/4"  | 40mm x 0.5        |
| 35-412 | Spacer 3/8"  | 40mm x 0.5        |
| 35-413 | Spacer 1/2"  | 40mm x 0.5        |
| 35-414 | Spacer 3/16" | 40mm x 1.0        |
| 35-415 | Spacer 1/4"  | 40mm x 1.0        |
| 35-416 | Spacer 3/8"  | 40mm x 1.0        |
| 35-417 | Spacer 1/2"  | 40mm x 1.0        |

## STAHL BLADE HOLDERS, DIE BLOCKS, DIE COLLARS (partial listing)

| Mfr. #      | Description                              | Slittershaft Size |
|-------------|--|-------------------|
| M203558BG04 | Transport Collar, steel/poly             | 25mm              |
| M2131860100 | Transport Collar w/groove                | 25mm              |
| M203558BG05 | Transport Collar/steel                   | 25mm              |
| M203558BG10 | Transport Collar, Stahl B14/T36          | 20mm              |
| M203558BG11 | Transport Collar/steel, Stahl B14/T36    | 20mm              |
| M203558BG01 | Transport Collar                         | 35mm              |
| M2175300100 | Transport Collar w/groove                | 35mm              |
| M203558BG02 | Transport Collar/steel                   | 35mm              |
| M202845BG04 | Transport Collar/2-groove block          | 35mm              |
| M203558BG12 | Die Block, Stahl B14/T36                 | 20mm              |
| M203558BG06 | Die Block                                | 25mm              |
| -           | Die Block, 2-sided                       | 25mm              |
| M203558BG03 | Die Block                                | 35mm              |
| -           | Die Block, 2-sided                       | 35mm              |
| M203559BG01 | Blade Holder                             | 35mm              |
| M203559BG02 | Blade Holder, center trim                | 35mm              |
| -           | Blade Holder, center trim 1"             | 35mm              |
| -           | Blade Holder, center trim 1-1/2"         | 35mm              |
| M203559BG04 | Blade Holder                             | 25mm              |
| M203559BG03 | Blade Holder, center trim                | 25mm              |
| -           | Blade Holder, center trim 1"             | 25mm              |
| M203559BG09 | Blade Holder, Stahl B14/T36              | 20mm              |
| -           | Blade Holder, center trim, Stahl B14/T36 | 20mm              |

## MBO TRIM SPACERS

| Mfr. # | Description  | Slittershaft Size |
|--------|--------------|-------------------|
| 35-400 | Spacer 1/4"  | 40mm x 0.5        |
| 35-401 | Spacer 3/16" | 40mm x 0.5        |
| 35-402 | Spacer 1/2"  | 40mm x 0.5        |
| 35-403 | Spacer 3/16" | 40mm x 1.0        |
| 35-404 | Spacer 1/4"  | 40mm x 1.0        |
| 35-405 | Spacer 3/8"  | 40mm x 1.0        |
| 35-406 | Spacer 1/2"  | 40mm x 1.0        |
| 35-407 | Spacer 1/4"  | 40mm x 2.0        |
| 35-408 | Spacer 1/2"  | 40mm x 2.0        |
| 35-433 | Spacer 1/8"  | 35mm              |
| 35-434 | Spacer 3/16" | 35mm              |
| 35-435 | Spacer 1/4"  | 35mm              |
| 35-436 | Spacer 3/8"  | 35mm              |
| 35-437 | Spacer 1/2"  | 35mm              |

\*Registered trademarks of MBO & Stahl

# MBO\* Perfs/Scores/Slitters

## 30 mm SHAFT SIZE

| Mfr. Number   | Description   | #Teeth   | ID    | OD   | Type     |
|---------------|---------------|----------|-------|------|----------|
| M2.0.5591.020 | Score         | —        | 35 mm | 51.5 |          |
| M2.0.5591.080 | Score         | —        | 35 mm | 50.8 |          |
| M35mmSS       | SuperScore    | —        | 35 mm |      | Channel  |
| M2.0.5591.010 | Slitter       | —        | 35 mm | 53.5 |          |
| M2.0.5591.090 | Slitter-thick | —        | 35 mm | 53.5 |          |
| M2.0.5591.100 | Perforator    | 9 Teeth  | 35 mm | 54.0 | Punch    |
| M2.0.5591.120 | Perforator    | 10 Teeth | 35 mm | 53.0 | Spine    |
| M2.0.5591.070 | Perforator    | 12 Teeth | 35 mm | 53.0 | Spine    |
| M2.0.5591.030 | Perforator    | 15 Teeth | 35 mm | 53.0 | Head     |
| M2.0.5591.040 | Perforator    | 22 Teeth | 35 mm | 53.0 | Head     |
| M2.0.5591.050 | Perforator    | 42 Teeth | 35 mm | 52.5 | Tear Out |
| M2.0.5591.060 | Perforator    | 70 Teeth | 35 mm | 52.5 | Tear Out |

Head Perforating



Spine Perforating



Tearout Perforating



Punch Perforating



## 35 mm SHAFT SIZE

| Mfr. Number   | Description      | #Teeth   | ID    | OD   | Type     |
|---------------|------------------|----------|-------|------|----------|
| M5.0.210.020  | Score            | —        | 40 mm | 59.5 |          |
| M5.0.210.550  | Score            | —        | 40 mm | 58.8 |          |
| M5.0.210.860  | Score            | —        | 40 mm | 61.5 |          |
| M5.0.210.030  | Slitter-split    | —        | 40 mm | 61.5 |          |
| M5.0.210.260  | Slitter          | —        | 40 mm | 61.5 |          |
| M5.0.210.480  | Slitter-oversize | —        | 40 mm | 64.0 |          |
| M5.0.210.760  | Slitter          | —        | 40 mm | 61.5 |          |
| M5.0210.250.S | Slitter          | —        | 40 mm | 61.5 | Special  |
| M5.0.210.040  | Perforator       | 8 Teeth  | 40 mm | 61.5 | Head     |
| M5.0.210.730  | Perforator       | 8 Teeth  | 40 mm | 61.5 | Head     |
| M5.0.210.400  | Perforator       | 8 Teeth  | 40 mm | 61.5 | Spine    |
| M5.0.210.450  | Perforator       | 10 Teeth | 40 mm | 61.5 | Head     |
| M5.0.210.050  | Perforator       | 12 Teeth | 40 mm | 61.5 | Head     |
| M5.0.210.410  | Perforator       | 12 Teeth | 40 mm | 61.5 | Spine    |
| M5.0.210.270  | Perforator-punch | 12Teeth  | 40 mm | 63.0 | Punch    |
| M5.0.210.410  | Perforator       | 12 Teeth | 40 mm | 61.5 | Spine    |
| M5.0.211.160  | Perforator       | 15 Teeth | 40 mm | 61.5 | Head     |
| M5.0.211.620  | Perforator       | 12 Teeth | 40 mm | 61.5 | Head     |
| M5.0.210.970  | Perforator       | 16 Teeth | 40 mm | 61.5 | Head     |
| M5.0.210.470  | Perforator       | 16 Teeth | 40 mm | 61.5 | Head     |
| M5.0.210.060  | Perforator       | 18 Teeth | 40 mm | 61.5 | Head     |
| M5.0.210.390  | Perforator       | 18 Teeth | 40 mm | 60.0 | Tear Out |
| M5.0.210.070  | Perforator       | 28 Teeth | 40 mm | 61.5 | Spine    |
| M5.0.210.210  | Perforator       | 28 Teeth | 40 mm | 60.0 | Tear Out |
| M5.0.210.240  | Perforator       | 48 Teeth | 40 mm | 60.0 | Tear Out |
| M5.0.210.720  | Perforator       | 36 Teeth | 40 mm | 60.0 | Tear Out |
| M5.0.210.230  | Perforator       | 80 Teeth | 40 mm | 60.0 | Tear Out |

\*Registered trademark of MBO

**26 mm ID**

| Mfr. Number        | Description             | #Teeth |
|--------------------|-------------------------|--------|
| <b>Scores</b>      |                         |        |
| S200.742.1300      | Score, 37.0 OD          | —      |
| S200.742.1100      | Score, 37.5 OD          | —      |
| S200.742.1000      | Score 38.0 OD           | —      |
| <b>Slitter</b>     |                         |        |
| S200.747.1100      | Slitter, 39.0 OD        | —      |
| S205.970.0600      | Slitter, 38.0 OD, 1.2mm | —      |
| S226.341.0100      | Slitter, 39.0 OD, 1.0mm | —      |
| <b>Perforators</b> |                         |        |
| S200.750.0600      | Perforator, 39.0 OD     | 10     |
| S200.750.0500      | Perforator, 39.0 OD     | 15     |
| S217.636.0100      | Perforator, 37.5 OD     | 40     |
| S217.636.0200      | Perforator, 37.5 OD     | 60     |

**30 mm ID**

| Mfr. Number        | Description         | #Teeth |
|--------------------|---------------------|--------|
| <b>Scores</b>      |                     |        |
| S200.742.0400      | Score, 45.0 OD      | —      |
| S200.742.0200      | Score, 46.0 OD      | —      |
| <b>Slitters</b>    |                     |        |
| S200.747.0100      | Slitter, 48.0 OD    | —      |
| S205.970.0500      | Slitter, 48.0 OD    | —      |
| <b>Perforators</b> |                     |        |
| S200.750.0200      | Perforator, 48.0 OD | 10     |
| S205.980.0100      | Perforator, 48.0 OD | 10     |
| S205.990.0700      | Perforator, 48.0 OD | 10     |
| S226.348.0100      | Perforator, 47.5 OD | 10     |
| S226.402.0100      | Perforator, 47.5 OD | 10     |
| S200.759.0500      | Perforator, 48.0 OD | 12     |
| S205.990.0800      | Perforator, 48.0 OD | 12     |
| S200.750.0100      | Perforator, 48.0 OD | 15     |
| S200.750.0300      | Perforator, 46.0 OD | 15     |
| S226.348.0200      | Perforator, 47.5 OD | 15     |
| S226.402.0200      | Perforator, 47.5 OD | 15     |
| S200.750.0400      | Perforator, 46.0 OD | 17     |
| S200.759.0300      | Perforator, 48.0 OD | 18     |
| S200.758.0700      | Perforator, 47.3 OD | 24     |
| S205.990.1000      | Perforator, 48.0 OD | 24     |
| S200.758.0200      | Perforator, 48.0 OD | 30     |
| S200.758.0300      | Perforator, 46.0 OD | 40     |
| S200.758.0600      | Perforator, 48.0 OD | 60     |
| S205.958.0400      | Perforator, 45.0 OD | 60     |
| S205.985.0300      | Perforator, 44.6 OD | 60     |
| S200.759.0600      | Perforator, 48.0 OD | 72     |

**40 mm ID**

| Mfr. Number        | Description               | #Teeth |
|--------------------|---------------------------|--------|
| <b>Scores</b>      |                           |        |
| S200.742.1200      | Score, 59.0 OD            | —      |
| S200.742.0600      | Score, 60.0 OD            | —      |
| S200.742.0500      | Score, 61.0 OD            | —      |
| <b>Slitters</b>    |                           |        |
| S200.747.0400      | Slitter, 60.0 OD          | —      |
| S200.747.0300      | Slitter-split 61.5 OD     | —      |
| S200.747.0600      | Slitter-split 62.5 OD     | —      |
| S226.341.0300      | Slitter 61.5 OD           | —      |
| S205.970.0200      | Slitter-oversize, 64.0 OD | —      |
| <b>Perforators</b> |                           |        |
| S200.756.0700      | Perforator, 61.5 OD       | 5      |
| S213.028.0100      | Perforator, 64.0 OD       | 12     |
| S226.350.0100      | Perforator, 61.5 OD       | 12     |
| S226.401.0100      | Perforator, 61.5 OD       | 12     |
| S200.749.0200      | Perforator, 62.0 OD       | 18     |
| S226.350.0200      | Perforator, 61.5 OD       | 18     |
| S226.401.0200      | Perforator 61.5 OD        | 18     |
| S210.621.0100      | Perforator, 61.5 OD       | 28     |
| S200.756.0100      | Perforator, 61.5 OD       | 30     |
| S200.756.0200      | Perforator, 61.5 OD       | 32     |
| S200.754.0600      | Perforator, 59.0 OD       | 60     |
| S200.756.0600      | Perforator 61.5 OD        | 60     |
| S200.754.0200      | Peforator, 59.7 OD        | 80     |
| S200.754.0300      | Perforator, 59.0 OD       | 80     |
| S200.754.0400      | Perforator, 60.0 OD       | 80     |

**55 mm ID**

| Mfr. Number        | Description         | #Teeth |
|--------------------|---------------------|--------|
| <b>Scores</b>      |                     |        |
| S200.742.1400      | Score, 76.0 OD      | —      |
| S200.742.1500      | Score, 76.5 OD      | —      |
| S200.742.0800      | Score, 77.0 OD      | —      |
| S200.742.0700      | Score 78.0 OD       | —      |
| <b>Slitters</b>    |                     |        |
| S226.341.0400      | Slitter, 78.5 OD    | —      |
| S205.972.0100      | Slitter, 78.5 OD    | —      |
| S205.972.0400      | Slitter, 80.0 OD    | —      |
| S200.747.0800      | Slitter, 77.0 OD    | —      |
| S200.747.0700      | Slitter, 78.5 OD    | —      |
| <b>Perforators</b> |                     |        |
| S200.748.0400      | Perforator, 79.0 OD | 9      |
| S226.403.0100      | Perforator, 78.5 OD | 18     |
| S205.981.0100      | Perforator, 79.0 OD | 30     |
| S226.349.0200      | Perforator, 78.5 OD | 30     |
| S226.403.0200      | Perforator, 78.5 OD | 30     |
| S200.748.0300      | Perforator, 79.0    | 40     |
| S200.755.0100      | Perforator, 76.5 OD | 70     |

\*Registered trademark of Stahl

# FOLDER REBUILD KITS, *Rollers*

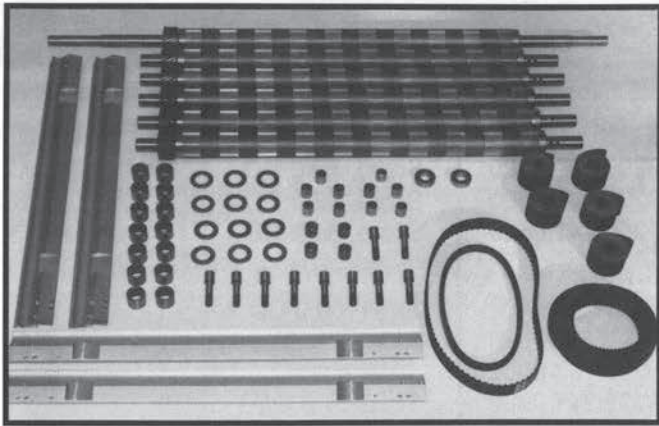

## NEW ROLLERS

MSI sells replacement rollers for most folders, including:

- BAUM
- DEXTER
- FALTEX
- MBO
- O&M
- PROFOLD
- STAHL
- VIJUK

For Baum & O&M models choose from several materials such as steel, combo, rubber or urethane. We can help you determine what is best for your application.

## SEGMENTED GLUE ROLLERS

Increase your gluing productivity even more, with less glue buildup –

- Non-Slip roller segments stay in place with set screw.
- Individual segments are replaceable.

## SEGMENTED GLUE NOSE UNITS

- Durable glue nose units available for flip and stationary deflectors for Stahl folders.

*Please have machine model and serial number available when ordering kits and new rollers to ensure correct parts.*

\*Registered trademarks of Baum, O&M, Stahl & Profold

## REBUILD KITS

### BAUM • O&M • STAHL • PROFOLD\*

- **Save \$\$\$** – Rebuilding can save you thousands of dollars over the price of a new machine.
- **Best value** – save \$ compared to purchasing parts individually.
- **Kits** – available for most models.

*Repair Service is available.  
Call for quote, questions or to order!*

## ROLLER RECOVERY, REGRINDING

- **Recover** your BAUM, O&M & STAHL rollers with new urethane at almost 1/2 the cost of purchasing new rollers. Rubber recovery also available for Baum rollers.
- **Our recovery house** uses a special process which straightens rollers in addition to recovering. This ensures that each roller runs true and works to its optimal performance.
- **Regrind** your MBO spiral rollers. Regrinding eliminates worn spots and brings new material to the surface.

**Ask us about converting your Baum steel rollers to combo!**

USE ONLY APPROVED ROLLER WASH WHEN CLEANING URETHANE OR RUBBER ROLLERS, AS SOME WASHES CAN CAUSE THE MATERIAL TO SWELL.

*MSI recommends  
VWM roller wash,  
available on page 14.*

# ELECTRICAL Plugs/Switches/Cable

## PLUGS & CONNECTORS

| Mfr. #                             | Description                             |
|------------------------------------|---|
| <b>Baum 700 Series:</b>            |   |
| -                                  | 20 pin male plug cpl, cord mount        |
| -                                  | 20 pin female insert cpl, base mount    |
| 21917                              | 4 pole male plug, 3 ph.                 |
| 22547                              | 4 pole female insert, base mount, 3 ph. |
| <b>Baum Legend/Liberty Series:</b> |   |
| 30447                              | 16 pin female insert                    |
| 30448                              | 16 pin female base, panel mount         |
| 30478                              | 16 pin male hood, cord mount            |
| 30479                              | 16 pin male insert                      |
| <b>Stahl Folders:</b>              |   |
| MS-210.921.0100                    | 6 pin male insert                       |
| MS-210.922.0100                    | 6 pin female insert                     |
| MS-210.923.0100                    | 6 pin base surface mount hood           |
| MS-210.924.0100                    | 6 pin top entry hood, cord mount        |
| MS-210.917.0100                    | 10 pin male insert                      |
| MS-210.918.0100                    | 10 pin female insert                    |
| MS-210.920.0100                    | 10 pin top entry hood, cord mount       |
| MS-215.495.0100                    | 10 pin base mount hood                  |
| <b>MBO Folders:</b>                |   |
| CL416/9H2187                       | Blue socket                             |
| CT416/9H2183                       | Blue plug                               |

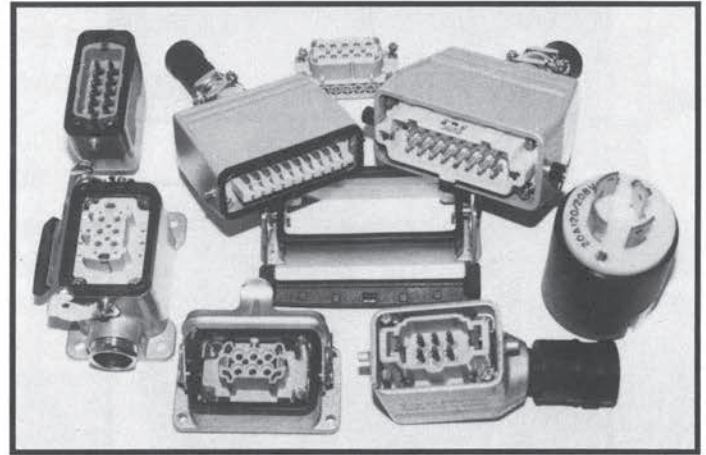

*All assemblies can be purchased as individual pieces.*

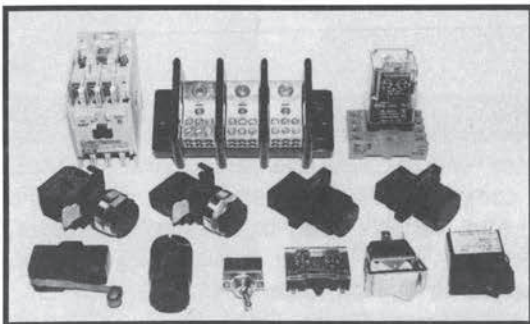

**Many Other  
Switches Available  
- Please Call**

## SWITCHES & ELECTRICAL CABLE

- PUMP SWITCHES
- STOP & START SWITCHES
- EMERGENCY SWITCHES (MUSHROOM)

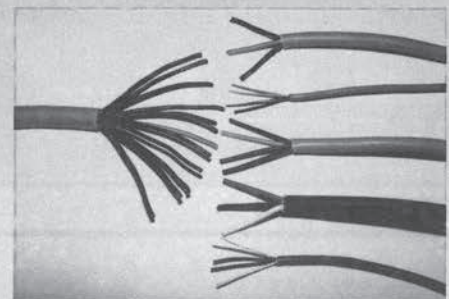

- CONTROL CABLE
- ADAPTER CABLES

# COUNTERS *Reliable, affordable - for the printing & binding industry*

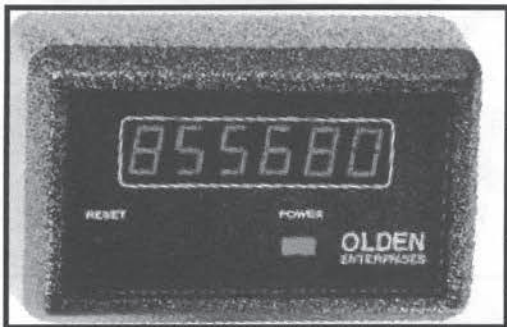

MODEL TC

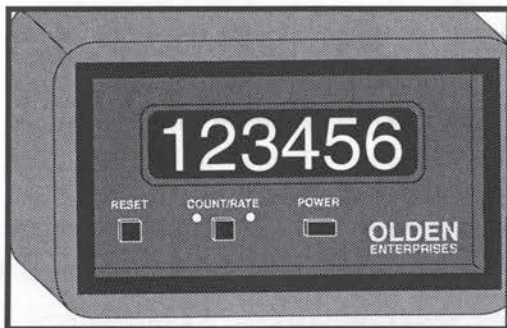

MODEL RTC

## THE TC (Total Count) & RTC (Rate & Total Counter) MODELS

\*Electronic memory uses advanced electronic circuitry to retain the count. There is no battery that ever needs replacement! 60% larger display than on previous 1000A and Memory counters. Numbers can be read from 20 feet. Sensitivity adjusts automatically. Sensor has a 10 foot curly cord mount with its own magnet. Counter comes with a new generation sensor and standard 6" post mount. Counter body is compact and easy to install without tools. On RTC model, switch between total count and rate at any time. Optional mounts available for both models.

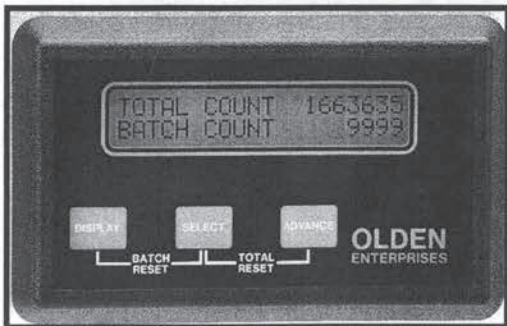

THE BATCH COUNTER

## THE BATCH COUNTER

A seven digit total counter, two rate meters and job time display in one compact, easy to operate unit. Four digit maximum batch size. Variable delay time controls feeder or convertor. The counter body can be ordered with different accessory packages for use on folders, stitchers, inserters, etc. Easy to install on most Baum, O&M, MBM, Stahl and MBO folder models. Uses same mounts as other models.

### Specifications:

|                         |                        |
|-------------------------|------------------------|
| Running Time Displayed: | 99.99 hours            |
| Max Total Count:        | 9,999,999              |
| Preset Batch Delay:     | 0.1 - 9.9 seconds      |
| Preset Batch Size:      | 1-9,999                |
| Counter Size:           | 5.5"w x 3.5"h x 2.5"d  |
| Max. Counting Speed:    | 400,000+ per hour      |
| Sensor Size:            | 1.5" x 1" x .6"        |
| Max. Rate Displayed:    | 90,000 per hour        |
| Power Required:         | 110 Vac, 15 Watts Max. |

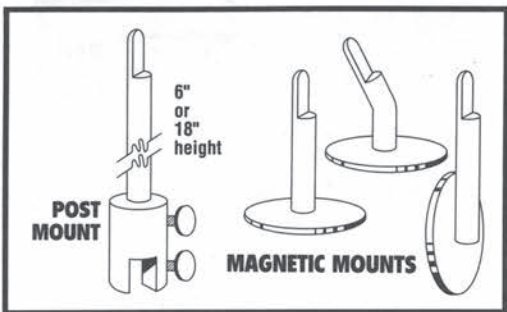

# Replacement Parts & Supplies **CUTTER**

## BAUM 30.50 CUTTERS

**MSI is the authorized parts dealer for Baum 30.50 cutters**

*Call us for:*

- BATTERIES • BELTS • CUTTING KNIVES & STICKS • ENCODERS
- HYDRAULIC PUMPS • KNIFE CHANGING SCREWS • KNIFE CYLINDERS
- NEGATOR SPRINGS • POWER SUPPLIES • PRESSURE GAUGES
- SHEARBOLTS • SOLENOIDS • SWITCHES • VALVES...

*. . . And all of your Cutter needs*

*We also sell  
replacement parts for  
Lawson\* Cutters!*

## CUTTER SUPPLIES

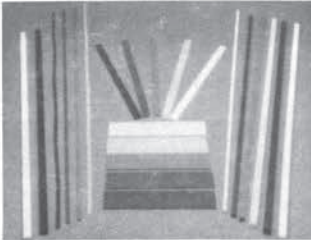

### **Plastic CUTTING STICKS**

The most resilient cutting sticks manufactured anywhere in the world. Durable and economical. Guaranteed fit. Available in every size for every cutter.

*Made in the USA.*



### **Paper CUTTING KNIVES**

CHALLENGE...LAWSON...POLAR...IMPERIAL...SEYBOLD...MBM...C&P... TRIUMPH...HORIZON...MULLER...WOHLENBERG...SCHNEIDER...PIVANO... MARTIN YALE...AND MANY MORE!

Available in standard "DIAMOND CUT™" or "DIAMOND CUT HSS™" 18% Tungsten, High Speed Steel.

*\*Manufactured to precise OEM specifications.*

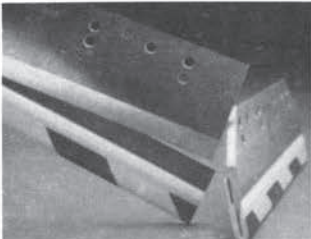

### **Plastic KNIFE GUARD**

Engineered and manufactured from a high impact polymer which means safety and security to machine operators and your valuable blades.

*\*Essential on 3-knife trimmers.*

*Made in the USA.*

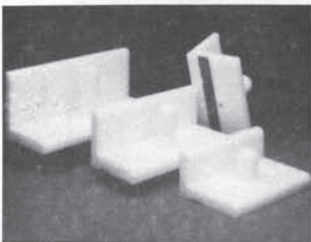

### **Plastic JOGGER BLOCK**

Durable Kimoplastic™ construction coupled with an aggressive magnetic base ensures clean and precise jogging and alignment of stock.

3" high - 4" high - 5" high - 6" high  
Available in various lengths.

*Made in the USA.*

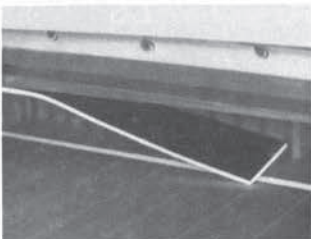

### **Magnetic CLAMP PAD**

Protects carbon paper, NCR and other stock from clamp pressure damage. A heavy-duty cushion pad laminated to a rubberized magnetic strip prevents unwanted marks on the valuable materials being cut.

2 pads per package • 3" wide x 15" long

*Made in the USA.*

\*Registered trademark of Lawson

# ACCESSORIES, SUPPLIES

## ANDERSON BANDERS

All the folder speed in the world won't help production if you can't package fast enough! The Speedo banding press from Anderson allows for faster packaging and more accurate counts. Also helps to minimize waste.

**12" Model** (12.5" between head openings, 3.5" wide paper band capacity.) - #AB12

Also available in extra long, opening to 17" - #AB17

## SELF SEAL PAPER BANDS

Enhance your production even more and gain neater, more professional looking packages in the process! Available in a wide range of sizes. Sold by the carton. Please call for prices and samples.

## TINSEL, STATIC STRING

### TWO LOW COST WAYS TO KEEP STATIC IN CHECK:

- Tinsel, 24 yards per carton
- **NEW!** Static String – This ionizing cord is a low cost, light weight static eliminator. Users report up to 99% static removal. Available in 72' rolls and 1000' rolls.

*For severe or continuous static problems, call MSI for info on our static Eliminators*

## FOLDING BONES

Facilitates hand-folding of paper and cover stock. Great for hand scoring also. Available in 8" or 9" lengths, either pointed one end or rounded both ends.

8" rounded both ends - #B8

9" rounded both ends - #B9

8" pointed one end - #BP8

9" pointed one end - #BP9

## NITRILE GLOVES

No more dirty hands! A quality, cost-effective alternative to ordinary natural rubber and vinyl disposable gloves.

Non-latex, 100% soft nitrile. Puncture resistant and will hold up well under use with a broad range of chemicals.

100 gloves per box. - #NG100

## RUBBER CLEANER & REJUVENATOR

Deglazes blankets, rollers and tires for longer wear and better performance. - #RCL-RE

## TESA TAPE

*For folding coated jobs that need more grip!*

When wrapped around a roller in a spiral format, Tesa Tape creates a tacky surface alleviating paper slippage and inconsistent folding. Works especially well on coated stock. Easy to remove.

#TT3.4 3/4" roll x 27.5 yards

#TT1 1" roll x 27.5 yards

## VWM ROLLER WASH

Be kind to your folder rollers! Recommended by leading folder manufacturers for cleaning rubber and urethane, as well as steel. Works the best of any we've tried and will not cause swelling of the urethane or rubber.

#VWM1 1 gallon

#VWM5 5 gallons

## PADDING COMPOUND

**RC13** 13 oz. cans

A water soluble vinyl adhesive designed for flexibility and strength. Choose standard drying speed or fast dry for high production work. Available in red or white, quart or gallon. Non-toxic, no VOC's.

#PCRQ Red, quart

#PCRG Red, gallon

#PCWQ White, quart

#PCWG White, gallon

## PAD SEPARATING KNIFE, BRUSHES

**Knife** – Makes separating pads easy and efficient. Wooden handle with carbon steel blade measures 3" x 1 3/8".

#PSK

**Brush** – 2" natural bristles with chrome-plated ferrule and wooden handle. Convenient width fits into all padding compound jars. 2/poly bag.

#PB-2

## ADJUSTABLE PAD COUNTER

Wooden handle with chrome plated steel assembly.

Standard of the industry.

3" lift capacity - #APC3

4" lift capacity - #APC4

5" lift capacity - #APC5

## HAND CLEANING TOWELS

These wipes combine citrus-scented cleaner with non-scratching, abrasive towels. Traps dirt, grease, oil, ink and tar. Packed 36 or 72 wipes per bucket.

36 count Scrubs-In-A-Bucket - #MIS-SIB-36

72 count Scrubs-In-A-Bucket - #MIS-SIB-72



## WRENCHES

### T-HANDLE ALLEN WRENCH

Our most popular wrench! Rubber "T" handle is easy on the hands. Long length gets into those hard-to-reach areas. Available in 9" length hex end and 6" length ball end.

*Other sizes available - please inquire.*

### HEX KEYS, BALL END KEYS

Available in most sizes, both metric and American.

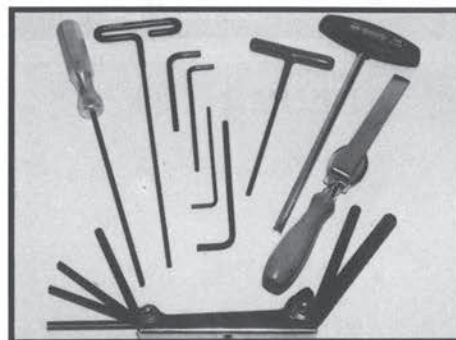

## LUBRICATORS

### OIL CANS

6 ounce capacity.

- Rigid spout, 6" - #OLR-10
- Flex spout, 6" - #OLF-10

### GREASE GUNS

Several varieties available from mini-pistol guns to heavy duty. Cartridge or bulk fill.

### HYDRAULIC OIL FILTER

For Lawson and 30.50 Cutters

- Spin on type, #M30265
- Bolt on type (fits in cannister), #M30265K

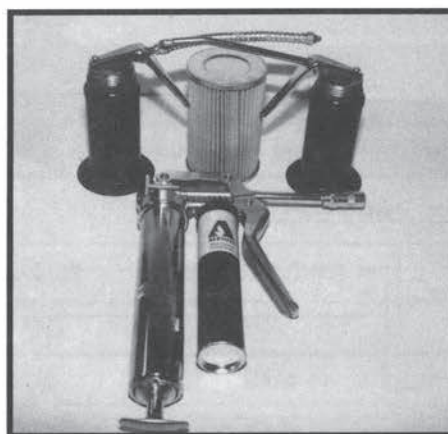

## SELF-LUBRICATING GREASE CARTRIDGES

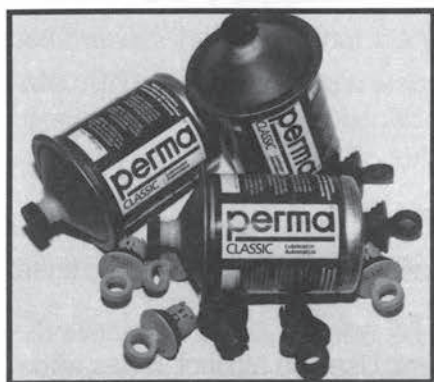

### *Fight the #1 cause of equipment failure!*

Newer folding machines (Stahl, Baum Legends and 2015/18/20 models) use self-lubricating grease cartridges as their source of grease. Replace them once or twice a year to ensure your folder gets the ongoing lubrication it requires.

- 6-Month Cartridge - #PL6
- 12-Month Cartridge - #PL12

### *Protect your investment!*

Sign up for MSI's Automatic Renewal Program and we'll send new cartridges to your door at pre-determined intervals—at no additional charge! You can install them yourself or have an MSI technician do it for you.\* No Hassle! No Forgetting! Call today for more information.

\*Billable at MSI's current labor rates.

Join MSI's  
Automatic  
Renewal  
Program!

# DRILLS, WET SCORES Replacement Parts

## DRILL BITS

- BAUM
- CHALLENGE
- IRAM
- LAWSON
- NYGREN DAHLEY
- SPINNET\*

When ordering drills, please specify overall length and drill capacity.

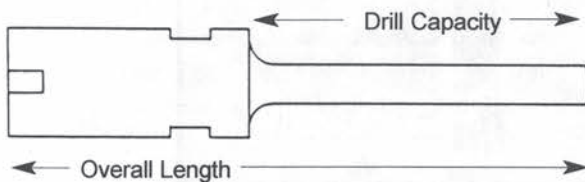

\*Registered trademarks of Baum, Challenge, Iram, Lawson, Nygren Dahley & Spinnet

## DRILL EASE LUBE STICK

Apply Drill Ease to drill bits to facilitate drilling and eliminate burning. Handy stick allows lube to be applied like a crayon!

### AVAILABLE SIZE DRILL BITS

|      |        |       |        |
|------|--------|-------|--------|
| 1/8" | 5/32"  | 3/16" | 7/32"  |
| 1/4" | 9/32"  | 5/16" | 11/32" |
| 3/8" | 13/32" | 7/16" | 1/2"   |

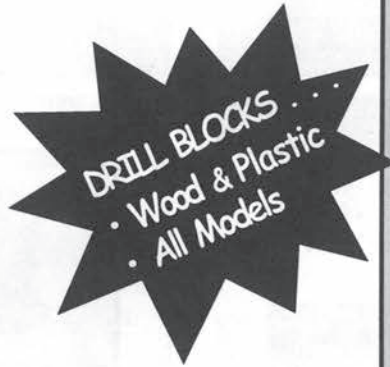

## HYDRA-SCORE WET-SCORE SYSTEM



### THREE MODELS:

**Model 100M2** – Manual shut-off

**Model 100E2** – Electric shut-off

**Model 100EA62** – Automatically controlled by electric sheet sensor.

**SW938** – Wet-fold treatment. Uses no alcohol. Mixes with water and works on a variety of paper stocks.

- Wet scores can run up to 4 lines
- Mounting bar kits available for Baum, MBO & Stahl\* Folders

\*Registered trademarks of Baum, MBO & Stahl

# STITCHING WIRE

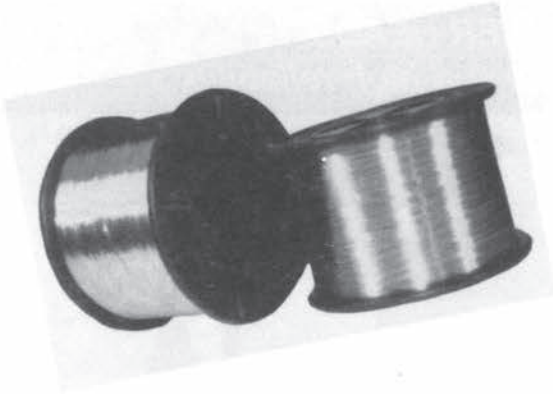

**DEREELERS AVAILABLE**  
Eliminates wire tangles  
on 30 and 70 lb. spools

**High Quality Wire means  
LESS DOWNTIME &  
LESS WASTED WIRE!**

## "Low Tension" Spooling

Process provides you with smoother take off and reduces tangles.

## Pre-lubricated

Lightly lubricated wire provides you with smoother running wire and less wear on your stitcher head.

## Hardness Choice

Choose the wire hardness that fits your job:

- **STANDARD:** Economical and smooth running – perfect for most bindery operations.
- **"X"** : A slightly stronger stitch.
- **"XXX"** : For the toughest stitching jobs – it's tough as nails!

Available on 5, 10, 30 and 70 lb. spools.

**Per case:**

5 lb. = 10 spools/case

10 lb. = 5 spools/case

## COLORS AVAILABLE!

Enhance the look of your finished product for only a few pennies more. Available in copper, brass, stainless steel finish or red, white, blue and black.

## WIRE SPECIFICATIONS

Wire available in all 3 hardness levels

### ROUND WIRE

| GAUGE | SIZE IN INCHES | INCHES PER LB. |
|-------|----------------|----------------|
| 17    | .054           | 1543           |
| 18    | .0475          | 1995           |
| 20    | .0348          | 3715           |
| 21    | .0317          | 4477           |
| 22    | .0286          | 5500           |
| 23    | .0258          | 6760           |
| 24    | .0230          | 8496           |
| 25    | .0204          | 10800          |
| 26    | .0181          | 13728          |
| 27    | .0137          | 15036          |
| 28    | .0162          | 17148          |

### FLAT WIRE

| GAUGE     | SIZE IN INCHES | INCHES PER LB. |
|-----------|----------------|----------------|
| 18 x 20   | .0475 x .0348  | 2430           |
| 19 x 21.5 | .041 x .0301   | 3280           |
| 19.5 x 21 | .0397 x .0317  | 3470           |
| 20 x 24   | .035 x .023    | 4993           |
| 20 x 25   | .035 x .020    | 5340           |
| 21 x 25   | .032 x .021    | 5930           |

# STITCHERS, HEADS, REPLACEMENT PARTS



## HOHNER HEADS ...for long life and high reliability

| Model   | Wire Size                    |
|---|------------------------------|
| <b>Universal 43/6</b><br>Standard Stitch<br>(loop heads available)  | #24-26 round<br>#26-28 round |
| <b>Universal 48/5-S</b><br>Standard Stitch<br>(loop heads available)  | #24-28 round<br>#26-30 round |
| <b>Universal 52/8</b><br>Standard Stitch<br>(loop, ribbon & flat<br>wire heads available)                           | #24-28 round<br>#26-30 round |
| <b>M50/8</b><br>Standard Stitch<br>(for Muller-Martini<br>heads -replaces<br>HK55 & HK75)<br>(loop heads available) | #24-28 round<br>#26-30 round |
| <b>Universal 70/20</b><br>Standard Stitch<br>(For thicker work)   | #24-30                       |



\*Registered trademark of Muller-Martini

## REPLACEMENT PARTS AVAILABLE FOR ALL HOHNER HEADS!

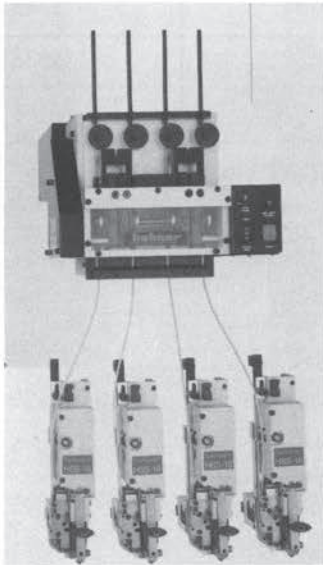

**HSS 18 - SELECTIVE STITCHING SYSTEM**  
...designed to run on machines using 18D or 70/20 style heads.

**STANDARD STITCHING**

- Maximum thickness: 12.5mm (0.49 in.)
- Minimum distance between staples: 56-76mm (2.21-2.99 in.)
- Crown width: 14mm (0.55 in.) #24-28 round  
Exchange parts available at no extra charge for round wire #21-23

# REPLACEMENT PARTS, STITCHERS, HEADS

**DELUXE/BOSTITCH**  
*Machines, Heads and Parts*

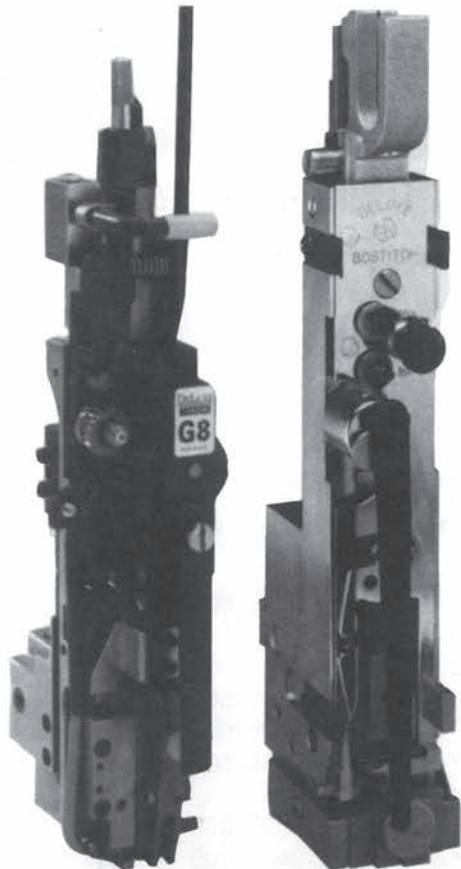

**REPLACEMENT PARTS**  
for Deluxe/Bostitch &  
Muller-Martini\* Heads

## STITCHING HEADS

| Model                                    | Wire Size (gauge)                             |
|--|---|
| G8 Side Feed                             | #23-28 round<br>21x25 flat                    |
| G20 Side Feed                            | #20-28 round<br>21x25, 20x24 flat             |
| 26/26 D Swivel-style                     | #23-28 round<br>21x25 flat                    |
| 18D Swivel-style                         | #20-28 round<br>19x21 1/2, 20x24 & 21x25 flat |
| DB75/DB75V<br>Muller Replacement<br>Head | #20-28 round<br>21x25 and 20x24 flat          |

**REPLACEMENT PARTS**  
for MULLER-MARTINI  
& McCAIN STITCHERS

- GATHERING CHAIN
- CHAIN FINGERS
- SUCKERS
- MASTER LINKS
- RAILS
- CLINCHERS

*... And Much More!*

**CONVENIENT  
REPAIR KITS AVAILABLE**

FOR THE

**26/26E, 7, M7 & G8 HEADS**

*As well as replacement parts for:*

- BOSTITCH
- INTERLAKE
- ACME
- CHAMPION
- MULLER-MARTINI
- McCAIN\*

\*Registered trademarks of Bostitch, Interlake, Acme, Champion, Muller-Martini & McCain

# PUMPS & FILTERS

## GAST\* REPLACEMENT PUMPS

### Full Line of:

- Gast Air Motors
- Vacuum Pumps
- Air Compressors
- Blowers

### Replacement Parts:

- Gast
- Rietschle
- Busch
- Becker
- Orion Pumps

• VANES

• BEARINGS

• GASKETS

• REPAIR KITS

• FILTER JARS

## FILTERS

| Mfr. #                     | Rietschle | Becker       | Gast   |
|----------------------------|-----------|--------------|--------|
| <b>BAUM</b>                |           |              |        |
| 21083                      |           |              | AB601G |
| 21499                      |           |              | AA905G |
| 21502                      |           |              | D344B  |
| 21504                      |           |              | AA905F |
| 30333                      |           |              | B343B  |
| 30435                      |           |              | AC393  |
| BP74000105                 |           | Becker T4.25 |        |
| BP84040107                 |           | Becker T4.25 |        |
| <b>STAHL<br/>&amp; MBO</b> |           |              |        |
| C31                        |           |              |        |
| C31/1                      | 730501    |              |        |
| C32                        | 730502    |              |        |
| C35                        | 513457    |              |        |
| C37                        | 515339    |              |        |
| C42/1                      | 730504    |              |        |
| C42/2                      | 730503    |              |        |
| C43                        | 730505    |              |        |
| C44                        |           | 90951800     |        |
| C46                        | 515340    |              |        |
| C48                        | 513458    |              |        |
| C64/1                      | 730506    | 90953600     |        |
| C64/3                      |           | 90951900     |        |
| C66                        | 730507    | 90953500     |        |
| C66/1                      | 730524    |              |        |
| C74                        |           | 90950800     |        |
| C75                        | 7305042   | 84040105     |        |
| C75/2                      | 730354    | 90950500     |        |
| C75/4                      | 730518    |              |        |
| C76/2                      | 730587    | 90952100     |        |
| C78/2                      |           | 90950900     |        |
| C78/6                      |           | 90952900     |        |
| C79/1                      | 730508    | 90953200     |        |
| C79/2                      |           | 84040405     |        |
| C610/2                     | 515310    |              |        |
| C711/1                     | 730511    |              |        |
| C713                       | 730545    | 90951000     |        |
| C718                       |           | 90951400     |        |
| C912                       | 730392    | 90950600     |        |
| C1049                      | 730512    |              |        |
| C1049/1                    | 730521    | 90951200     |        |
| C1112                      | 730514    | 84040107     |        |
| C1112/2                    |           | 90950700     |        |
| C1132                      | 730080    | 84040209     |        |
| C1337                      | 730519    | 84040207     |        |
| C15124-1                   | 730517    | 84040110     |        |

\*Registered trademark of Gast Mfrs.

# Replacement Parts **GLUE SYSTEMS**

**Fold & Bind  
in one  
operation!**



## **BAUMER HHS\* HOT-MELT SYSTEMS**

- **Save Time** – eliminate double pass from folder to tabber.
- **Save Money** – hot-melt adhesive can be less expensive to use than other methods.
- **Increase Production** – HHS Systems will apply hot melt adhesive at any desired folder speed.

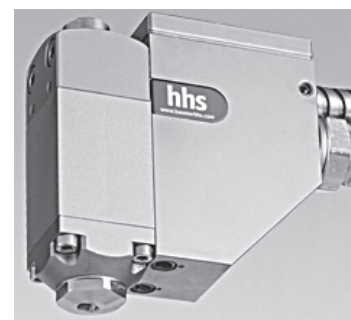

## **PAFRA\* COLD GLUING SYSTEMS**

### **PAFRA SYSTEMS OFFER:**

- High Accuracy
- Maximum Flexibility
- Simple Operation
- Fast Make-Ready Time
- Choice of Glue Line Widths & Positions
- Contact & Non-Contact Systems

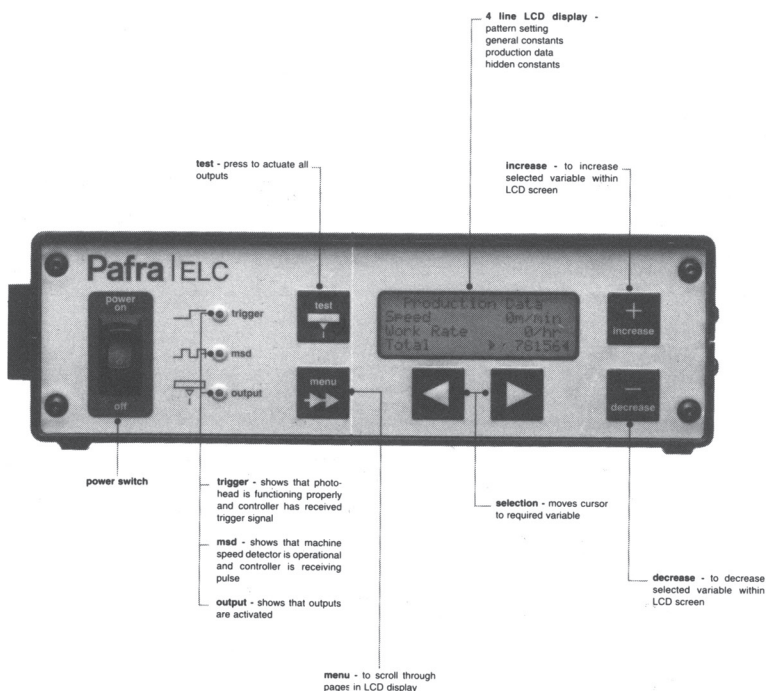
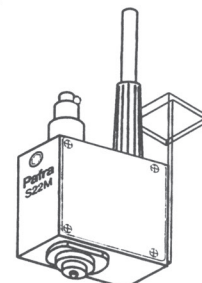

\*Registered trademarks of Baumer HHS and Pafra



**MSI BINDERY PARTS**  
PO BOX 415  
Hopewell Junction, NY 12533



**PH: 845-897-2688**

