

**Vertex**

**PLEASE READ ME FIRST**

**1. Preface**

1.1 Welcome to Magnum Bikes.....	04
1.2 Symbols.....	04
1.3 General Warning.....	04-05

**2. Safety**

2.1 Safe Riding Practices.....	06
2.1.1. Intended Usage of the Vertex.....	06
2.2 Battery & Charger.....	07
2.3 Riding with Accessories & Cargo.....	07-08
2.4 Riding with Children as Passengers.....	08-09
2.5 Riding in Various Conditions.....	09
2.5.1. Wet Weather.....	09
2.5.2. Night Riding.....	09
2.6 Compatible Parts & Accessories.....	09-10

**3. Illustrations**

3.1 Electrical.....	10
3.2 Mechanical.....	11
3.3 Frame.....	12
3.4 Cockpit.....	12

**4. Bicycle Overview**

4.1 Battery.....	13-14
4.2 Charger.....	14-15
4.3 Motor.....	15
4.4 Display.....	15-20

**5. Assembly**

5.1 Out of the Box Assembly.....	21
5.1.1. Unpacking the Bike.....	21
5.2 Torque Settings.....	22
5.3 Battery Installation.....	23
5.4 Pedal Installation.....	24
5.5 Warnings.....	24-25

**6. Storage**

6.1 Battery Storage.....	25
6.2 Bike Storage.....	25

**7. Maintenance**

7.1 Cleanings.....	27-28
7.2 Drivetrain.....	28

**8. Legal**

8.1 Warranty.....	28-29
8.2 Exclusions.....	29-30
8.3 Disclaimer.....	30
8.4 Prop.65.....	30

## 1. Preface

### 1.1 Welcome to Magnum Bikes

Welcome to the Magnum Bikes community. We're honored that you've chosen a Magnum as the bike that you'll be enjoying for years to come. Should you have any questions about your new Magnum Bike, we're here to help answer any question or questions that may arise.

Email: [info@magnumbikes.com](mailto:info@magnumbikes.com)

Phone: 323-375-2666

Magnum Bikes Help Center

### 1.2 Symbols

#### ▲ WARNING

Serious injury, may cause death if one does not obey the safety instructions

#### ▲ CAUTION

Situation can cause physical injury or material damage if one does not follow safety instructions

#### ● NOTICE

Important information to avoid problems

#### ● INFO

Provides additional information

### 1.3 General Warning

Like any outdoor activity, bicycling involves risk of injury and damage. By choosing to ride a bicycle, you assume the responsibility for that risk. It is important to understand and practice proper use, needed maintenance, and the rules of safe & responsible riding. Proper use and maintenance of your bicycle reduces risk of injury.

## ▲ WARNING

Inspect your frame, fork, and rims before every ride for damage or cracking. Do not operate a bike that has cracking or damage. Damage or cracking can lead to failure during operation. Failure to follow this warning could result in serious injury or death.

## ▲ WARNING

An approved bicycle helmet should always be worn when riding. Make sure that your child understands that a bicycle helmet is for bicycling only, and must be removed when not riding. A helmet must not be worn while playing, in play areas, on playground equipment, while climbing trees, or at any time while not riding a bicycle. Failure to follow this warning could result in serious injury or death.

## ● INFO

This manual contains important safety, performance, and service information. Read it before you take the first ride on your new Magnum E-Bike.

Additional safety, performance, and service information for specific components that you purchase (suspension, pedals, or accessories such as helmets or lights) may also be available. Make sure that your dealer has given you all the manufacturers' literature that was included with your bicycle and accessories. In case of a conflict between the instructions in this manual and information provided by a component manufacturer, always follow the component manufacturer's instructions.

If you have any questions or do not understand something, take responsibility for your safety and consult with your dealer or the manufacturer.

## ● INFO

As a parent or guardian, you are responsible for the activities and safety of your child, which includes making sure that the bicycle is properly fitted to the child; that it is in good repair and safe operating condition; that you and your child have learned and understand the safe operation of the bicycle; and that you and your child have learned, understand and obey not only the applicable local motor vehicle, bicycle, and traffic laws, but also the common sense rules of safe and responsible bicycling. As a parent, you should read this manual as well as review its warnings and bicycle's functions and operating procedures with your child, before letting your child ride the bicycle.

## ● INFO

The area in which you ride may require specific safety devices. It is your responsibility to familiarize yourself with the laws of the area where you ride and comply with all applicable laws, including properly equipping yourself and your bike as the law requires. Observe all local bicycle laws and regulations. Observe regulations regarding bicycle lighting, licensing of bicycles, riding on sidewalks, laws regulating bike path and trail use, helmet laws, child carrier laws, and special bicycle traffic laws. It's your responsibility to know and obey the laws.

## 2. Safety

### 2.1 Safe Riding Practices

#### ⚠ WARNING

It is important to carefully follow assembly instructions. Incorrect assembly, neglectful maintenance, or improper use of your Magnum bike can result in failure, loss of control, serious injury, or death. Regardless of rider experience, the operator of the Magnum bike must read and understand the entire manual and any other relevant instructions provided prior to riding. If you are unsure if you have the abilities, skills, and tools to properly assemble the bike, consult a local Magnum Bikes dealer or reputable bike mechanic.

#### Familiarize yourself and obey all applicable laws

Laws will vary from locality to locality. It is your responsibility to know, understand and obey the relevant laws to the region where you are riding your bike.

Become acquainted with your e-bike in a secure area prior to riding on the open road. Experiment with all the different pedal assist settings and with using the throttle (if allowed in your locality) to grow familiar with the results.

#### 2.1.1. Intended Usage of the Vertex

#### ⚠ WARNING

**Understand your bike and its intended use. Choosing the wrong bicycle for your purpose can be hazardous. Improper use of the Vertex can be and is dangerous.**

No one type of bicycle is suited for all purposes. Your dealer can help you choose the right bike for your needs and help you understand the benefits and limitations of different models.

#### ⚠ CAUTION

**Maximum weight limits are estimates based on several factors which may vary including but not limited to: riding style, road and terrain conditions and weight distribution. It is never advisable to continue to load the bicycle to its maximum capacity. If you have questions regarding the use of your bicycle at its maximum capacity please consult your Magnum Bikes dealer or contact Magnum Bikes customer support: 323-375-2666 or [info@magnumbikes.com](mailto:info@magnumbikes.com)**

The maximum load capacity for the Vertex is 350 pounds (159 kilograms).

### 2.2 Battery & Charger

#### ⚠ WARNING

Keep the battery away from children and pets.

Do not submit the battery to extreme temperatures, and store it in a clean dry place.

Keep the battery and charger away from water and open fire.

Do not drop or subject the battery and charger to any big shocks or impacts.

Charge the battery only with the charger that was supplied with the e-bike, or a replacement charger supplied by Magnum Bikes or an official Magnum dealer.

Do not use the battery and charger for purposes other than described.

Never connect the battery's terminals with each other.

Do not cover the battery and charger or place objects on top of it during charging.

Do not leave the battery and charger unattended while charging.

Disconnect the charger and the battery immediately if you notice a strange smell or smoke.

In the unlikely case that the battery is on fire: NEVER try to put the fire out with water. Vacate the vicinity and immediately call emergency services.

### 2.3 Riding with Accessories & Cargo

#### ⚠ CAUTION

The Vertex is not designed for transporting more than one rider. It is not recommended for passengers to be transported on this model.

The Vertex has a maximum load capacity of 350 pounds (159 kilograms). The load capacity includes the weight of the rider and any additional cargo or accessories.

## ⚠ WARNING

Never exceed the maximum load capacity. Doing so will put excessive stress on the frame and components, shortening their life-span, creating the possibility of failure.

Always make sure that any cargo or any other accessories are properly fitted to the Vertex in accordance with the manufacturer's instructions.

If a rear carrier rack is attached, do not exceed the manufacturer's maximum load capacity.

Ensure that there are no loose items or straps or other items that could get caught in the moving parts of the bicycle.

Cargo or accessories should not obstruct the rider's view, or impede the ability to properly operate the e-bike.

Always follow the instructions for installation and usage as dictated by the accessory manufacturer.

## ⚠ CAUTION

When riding with cargo or additional accessories, the bicycle may behave differently; particularly with steering and braking.

It is never advisable to continue to load the bicycle to its maximum capacity. If you have questions about your e-bikes maximum capacity, please contact Magnum Bikes at 323-375-2666 or [info@magnumbikes.com](mailto:info@magnumbikes.com).

### 2.4 Riding with Children as Passengers

## ⚠ WARNING

Never exceed the total maximum load capacity of the Vertex or the maximum load capacity of the rear carrier rack.

Always follow the installation instructions, the safety instructions, and the usage instructions of the child seat manufacturer.

Incompatible mounts or improper installation can cause the child seat to fail or become detached from the rear carrier rack, leading to serious injuries or death.

Not all brands and models will be compatible with the Vertex. It is essential that if a child carrier is used with the Vertex that it is fully compatible with the bike's rear carrier rack. Do not use a child carrier that is not fully compatible.

Never alter or modify the original parts, the frame, or any other stock part of the Vertex to accommodate a child seat or any other accessory.

## ⚠ CAUTION

It is not advised or recommended to operate the Vertex with children as a passenger. The Vertex is optimally designed for a single rider.

The use of a bicycle trailer will cause extra load and stress, increasing the wear on the e-bike's electrical and mechanical parts.

### 2.5 Riding in Various Conditions

It is the responsibility of the rider and operator to be aware of weather and lighting conditions. Should the rider choose to ride in inclement weather and/or poor visibility conditions, extra precautions should be taken.

## ⚠ WARNING

#### 2.5.1. Wet Weather

For all vehicles, wet weather impairs visibility, tire traction, and braking distance. Risk of an accident in inclement weather is significantly increased.

#### 2.5.2. Night Riding

Reflectors offer significantly less visibility for the rider than lights. Riding without an adequate lighting system during times of poor visibility is dangerous and may result in serious injury or death.

Children should never ride during times of poor or diminished visibility. Adults who choose to accept the greatly increased risk of injury while riding during times of poor or diminished visibility should take extra precautions while riding and should choose specific equipment to lessen that risk.

### 2.6 Compatible Parts & Accessories

## ⚠ WARNING

Do not exceed the maximum load capacity of the e-bike.

Follow the instructions for installation, safety, and usage as stated by the accessory that is to be used and installed on the e-bike.

Never modify any of the original parts or the frame of the e-bike to accommodate third party parts or accessories.

## ⚠ CAUTION

Not all third party parts and accessories are compatible with the Vertex. Consult your local dealer or Magnum support if unsure of compatibility or questions with assembly and installation.

## ⓘ NOTICE

If missing instructions, if instructions are not clear, if instructions are not understood, take the necessary actions to acquire and understand the instructions for installation and use prior to using the accessory.

### 3. Illustrations

#### 3.1 Electrical



- |               |                 |   |               |
|---------------|-----------------|---|---------------|
| 1. Display    | 3. Motor Cutoff | 5. Battery                                  | 7. Rear Light |
| 2. Cable Tree | 4. Front Light  | 6. Motor / Controller / Pedal Assist Sensor |               |

#### 3.2 Mechanical



- |                  |                       |                     |
|------------------|-----------------------|---------------------|
| 1. Tire          | 8. Brake Lever        | 14. Chain           |
| 2. Wheel         | 9. Disc Brake Caliper | 15. Rear Derailleur |
| 3. Valve Stem    | 10. Disc Brake Rotor  | 16. Cassette        |
| 4. Hub           | 11. Bottom Bracket    | 17. Seatpost Clamp  |
| 5. Thru-Axle     | 12. Crankset          | 18. Pedals          |
| 6. Quick-release | 13. Chainring         | 19. Kickstand       |
| 7. Shifter       |                       |                     |

### 3.3 Frame



- |              |              |              |                    |
|--------------|--------------|--------------|--------------------|
| 1. Head Tube | 4. Seat Tube | 7. Stem      | 10. Saddle         |
| 2. Top Tube  | 5. Chainstay | 8. Handlebar | 11. Seatstay       |
| 3. Down Tube | 6. Fork      | 9. Seat Post | 12. Bottom Bracket |

### 3.4 Cockpit

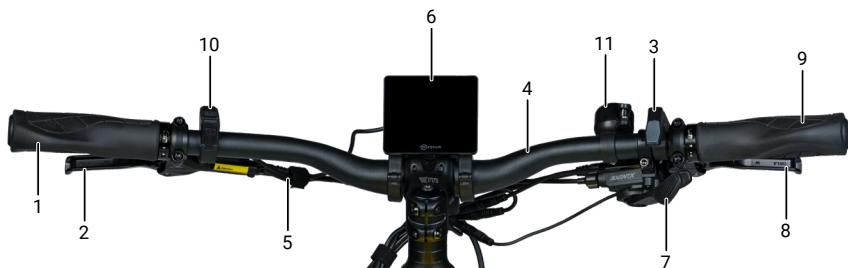

- |               |                 |                |                     |
|---------------|-----------------|----------------|---------------------|
| 1. Left Grip  | 4. Handlebar    | 7. Shifter     | 10. Display Control |
| 2. Left Brake | 5. Motor Cutoff | 8. Right Brake | 11. Bell            |
| 3. Throttle   | 6. Display      | 9. Right Grip  |                     |

## 4. Bicycle Overview

### 4.1 Battery

#### ⚠ CAUTION

The charger can become hot during charging. Avoid direct contact with the battery and charger during charging operation.

Failure to use a Magnum Bikes authorized charger may damage your battery in addition to voiding the warranty.

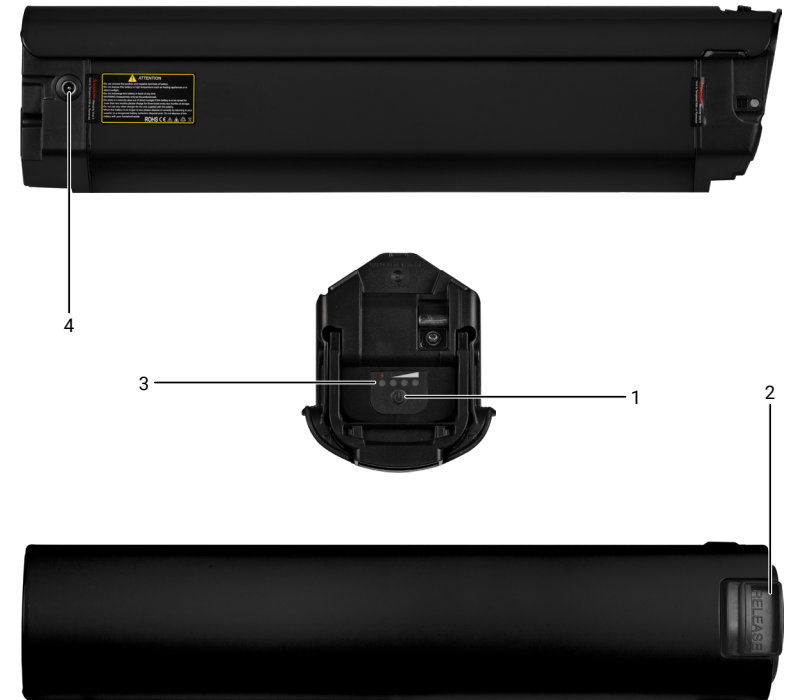

- |                     |                   |                 |                |
|---------------------|-------------------|-----------------|----------------|
| 1. Indicator Button | 2. Release Handle | 3. Charge Level | 4. Charge Port |
|---------------------|-------------------|-----------------|----------------|

## NOTICE

When the battery has reached the end of its service life, it should be treated as hazardous waste material. It should not be disposed of in regular household trash. Ask your dealer for advice or consult your local laws for proper disposal of the battery.

Not all batteries are compatible with all bikes. Check with a Magnum dealer or with Magnum Bikes customer support for questions about compatibility.

Charging at temperatures below 32°F (0°C) or above 122°F (50°C) can cause the battery to charge insufficiently and can be harmful to the life of the battery.

## INFO

If the battery is to be unused for a period longer than a month, the battery should be charged up to 80% every 30 days. Neglecting to do so will either shorten the life-cycle of the battery or cause the battery to no longer function.

### 4.2 Charger

Your Magnum Vertex battery should be charged with the supplied Magnum battery charger. Contact Magnum Bikes customer support (323-375-2666, info@magnumbikes.com) or your local Magnum dealer for the correct charger.

1. AC Plug<sup>1</sup>
2. Charger
3. Charging Indicator
4. Battery Plug

<sup>1</sup>Type may vary

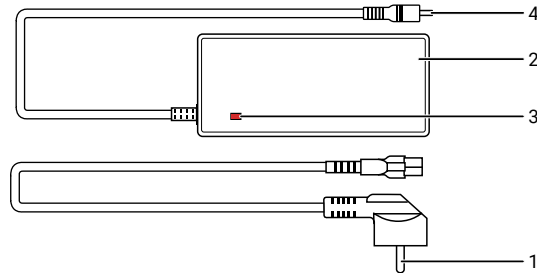

## WARNING

It is important that the correct and recommended charger be used for your battery. Failure to use the correct charger for your battery may result in your battery overheating, failing, possibly exploding.

Do not use your charger if it is damaged, non-functional, or performing abnormally. Using a damaged charger can damage the battery, possibly damaging the battery and leading to a fire hazard.

Do not use your charger if it has experienced a significant impact from a fall or crash, even if there are no obvious or apparent signs of damage or wear.

Do not use your charger if it becomes too hot to touch, is emitting an odd odor, or is showing signs of overheating. Disconnect the charger from the power source and the battery. Move the battery and charger to a safe location.

## CAUTION

Always ensure that the charger connectors are properly aligned with the battery's charging ports before connecting.

## NOTICE

Technical specifications and other details can be found on the printed label on the charger.

### 4.3 Motor

The Vertex's Ananda mid-drive motor works in conjunction with the rider to provide power assistance to the user. The motor is designed to offer assistance when the rider pedals and short bursts of throttle only motor power.

IP Rating: IPX5

Salt Spray Test Standard: 96h

### 4.4 Display

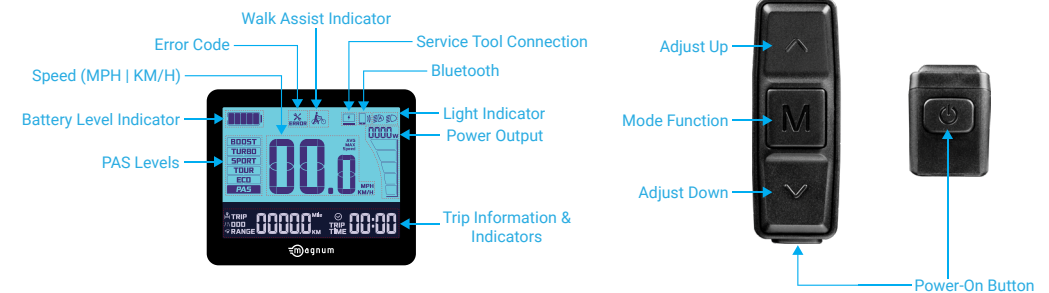

### Display Control

The display control will allow you to change the level of pedal assist, toggle through the display's readouts, turn the e-bike's lights on and off, and activate/deactivate walk mode.

Pressing the "Adjust Up" button will increase the pedal assist level. Pressing the "Adjust Down" button will decrease the pedal assist level.

To toggle through display functions, press the mode function button on the display control. This will toggle through Trip/Average, Odometer/Max.

Press and hold the "Adjust Up" button to activate the e-bike's integrated lights. The light icon on the display screen will show that the light system has been activated.

Press and hold the "Adjust Down" button to activate Walk-Mode, (speed must be below 3mph to activate). The display will show a "Walk-Mode" symbol upon activation. Release the "Adjust Down" to exit Walk-Mode.



### Trip, Odometer, & Range

Short press the M button to switch from TRIP, ODO, & RANGE on the display. The cycle order is TRIP/AVG, ODO/MAX, then RANGE/AVG. After 5 seconds with no operation performed on the M button and the bike speed greater than 0 the display screen will switch back to the main interface. The symbols below will indicate which value is being shown.



### Light Control

Long press the “adjust up” button to turn the headlight on and off. While the headlight is on the display’s backlight is dimmed.



### Speed Indication

The standard readout is real time speed, and can be switched to show average speed (AVG), and maximum speed (MAX).

### Battery Power

Battery power is shown by a battery bar indicator and percentage. The battery bar divides the power level into 5 bars. After battery capacity is lower than 5% the display enters low voltage mode. In this mode the battery level shows 0 bars. The battery outline will start blinking after reaching 1Hz, and with no power output from the motor, pedal assist will be disabled. The PAS level is displayed as OFF or 0. To get out of low voltage mode the battery will need to be charged.

SOC	Battery Level	Description
$80\% \leq \text{SOC}$		Full Battery Level 5
$60\% \leq \text{SOC} < 80\%$		Level 4
$40\% \leq \text{SOC} < 60\%$		Level 3
$20\% \leq \text{SOC} < 40\%$		Level 2
$10\% \leq \text{SOC} < 20\%$		Level 1
$5\% \leq \text{SOC} < 10\%$		Level 0
$0\% \leq \text{SOC} < 5\%$		Level 0 and Icon Blink at 1Hz

### Walk Mode

When speed is below 3mph long press and continue to hold the “adjust down” button to enter walk mode. Upon entering walk mode the display will show a walk mode symbol and the real-time speed while the PAS level displays as off (see image below). Release the adjust down button to exit walk mode. The motor is turned off and the display returns to the main interface.



## Change Settings





Within 10 seconds of turning on the display, press and hold the “Mode Function” button to enter the settings interface.





Use the “Adjust Up” and “Adjust Down” buttons to toggle between settings. Press the “Mode Function” button to enter a specific setting. The selected setting will blink. Press the “Adjust Up” or “Adjust Down” to locate the setting option you want, then press the “Mode Function” button to set the option. Press and hold the “Mode Function” button to exit to the previous page.

In settings, press the “Mode Function” button to scroll to the next menu. Press and hold the “Mode Function” button to exit and return to the previous menu.

## ! NOTICE

Please refer to the General Owner’s Manual for more information regarding the display settings.

Setting Items	Interface	Description	Setting Data	Remark
Unit Setting		UNT=Unit	Value=KM/H   MPH	Default Value=KM/H KM/H—Metric MPH—Imperial
Back Light Level Setting		bLG=Back Light	Value=LEVEL1, back-light level 60% Value=LEVEL 2 back-light level 80% Value=LEVEL 3 backlight level 100%	Default Value LEVEL1
Auto Shutdown Time		SLP=Auto Sleep	Value=0-30 min	Default Value=5min OFF means no auto shutdown
Real Time Clock		N/A	N/A	Hour : Minutes

Setting Items	Interface	Description	Setting Data	Remark
Software Version Info		DPS=Display Software Version	Read Only	Default Fix Value
Advanced Setting Interface		SET=setting	Enter with Passcode	For entering advanced setting items
<b>Advanced Settings Sub-Level Parameter Interfaces</b>				
Speed Limitation Setting		SPd=Speed Limitation	Value=PAS 3/4/6	Default: PAS 6 PAS 3=Pedal Assist 3 Levels Speed Limit 16MPH PAS 4=Pedal Assist 4 Levels Speed Limit 20MPH PAS 6=Pedal Assist 6 Levels Speed Limit 28MPH
Wheel Diameter Setting		dIA=Wheel Diameter	Value=16,20,24,26,27,27.5,28,700C,29 (default unit, inch)	Default Value=26
System Voltage Setting		Vol=System Voltage	Value=36/48V	Default: 48V

### Data Clearance

After 10 seconds of turning on the display, when the display shows the TRIP interface, long press the M button to show TRIP data.

While the TRIP icon is blinking short press the M button to confirm data clearance.

To exit long press the M button.

After clearance the subtotal mileage TRIP is 0, average speed is 0, and max speed is 0. ODO information can not be cleared on the display.



## i INFO

### Error Code

Each error code corresponds to a specific fault in the system. If an error code is displaying, contact Magnum Bikes or a Magnum Bikes dealer for assistance.

Error Code	Definition	Suggestion
3	Controller, speed sensor failure	Check controller/speed sensor
4	Brake/motor cutoff failure	Check cutoffs
6	Motor temperature fault	Check motor & stop riding
9	Controller over voltage or under voltage	Contact Magnum Bikes
30	Meter communication failure	Contact Magnum Bikes
37	Brake fault, speed sensor fault	Check speed sensor/magnet

If you still have questions about the display, please contact your Magnum dealer.

### Data Field

Distance: Riding distance since last reset PAS (Pedal Assist Sensor)  
 Pedal assist level indicator (Lowest to highest level of assist)  
 OFF ECO TOUR SPORT  
 TURBO BOOST BOOST+ (indicated by BOOST blinking)

### Adjust Up Button

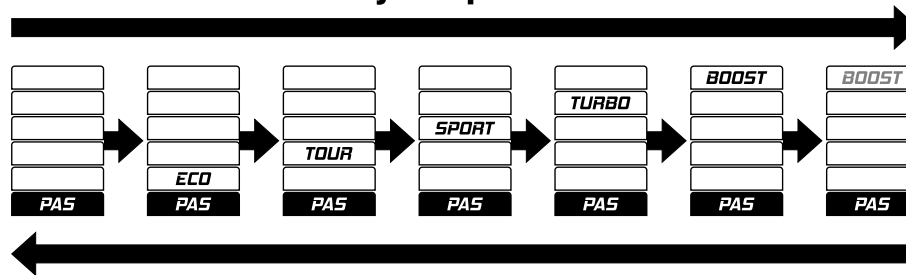

### Adjust Down Button

## 5. Assembly

The following sections are instructions for how to assemble your Vertex straight out of the box. The following steps are guidelines on the necessary steps, but they are not a comprehensive guide on all aspects of assembly. We recommend that you consult a reputable, certified bike mechanic to assist with assembly or to review assembly.

### 5.1 Out of the Box Assembly

#### 5.1.1. Unpacking the Bike

1. Open the box. Remove the staples from the flaps to prevent injuring yourself. With the help of another person, carefully remove the Vertex from the box. Carefully remove the packaging material from the Vertex. In the event that the bike needs to be returned, keep the packaging materials in case you want to ship the bike. Remove the small cardboard box from the bike box and set it aside. The small cardboard box will contain the battery charger and a pair of folding pedals.

2. In addition to the Vertex, ensure that the following pieces are included:

- a. Battery charger
- b. Pedals
- c. Battery keys and keychain
- d. Seatpost with attached saddle

3. If anything is missing, contact Magnum Bikes: 323-375-2666 or info@magnumbikes.com

## 5.2 Torque Settings

### **⚠ WARNING**

**Correct tightening force on fasteners - nuts, bolts, screws - on your bicycle is important. Too little force, and the fastener may not hold securely. Too much force and the fastener can strip threads, stretch, deform or break. Either way, incorrect tightening force can result in component failure, which can result in the operator's serious injury.**

Because manufacturers use a wide variety of fastener sizes and shapes made in a variety of materials, often differing by model and component, the correct tightening force or torque cannot be generalized. To make sure that the many fasteners on your bicycle are correctly tightened, refer to the torque specifications in the section.

Correctly tightening a fastener requires a calibrated torque wrench. A professional bicycle mechanic with a torque wrench should torque the fasteners on your bicycle. If you choose to work on your own bicycle, you must use a torque wrench and the correct tightening torque specifications provided in this section. If you need to make an adjustment at home or in the field, we urge you to exercise care, and to have the fasteners you worked on checked by your dealer as soon as possible.

#### Torque Values

Shifter.....	4–6 Nm
Throttle.....	1 Nm
Battery Seat.....	1.5–2.5 Nm
Kickstand.....	16–20 Nm
Crankset.....	35–50 Nm
Derailleur Hanger.....	4–6 Nm
Brake Lever Clamp Bolts .....	4–6 Nm
Display Mount.....	1 Nm
Front & Rear Brake Calipers Mounting Bolts.....	8–10 Nm
Cassette.....	40 Nm
Chainring.....	30–40 Nm
Motor Screw.....	35 Nm
Motor Cover Plate Screw.....	1–2 Nm
Stem Bolts.....	8–10 Nm
Stem Faceplate.....	5–7 Nm
Stem Top Cap Bolt.....	3.5–5.5 Nm

## 5.3 Battery Installation

### Battery Removal

Insert the key provided with the Vertex into the lock core. The lock core will be located above the battery on the non-drivetrain side. After insertion, turn the key to the unlock position to disengage the locking mechanism. While holding the key in the unlock position, push downward on the handle at the top of the battery, grab the top of the battery and pull out.

### Battery Installation

Insert the key into the lock core. Place the bottom of the battery into the bottom battery seat. Turn the key to the unlock position, push the top of the battery into the top battery seat, return the key to the lock position and remove the key from the lock core.

### **i INFO**

#### Charging the Battery

Your Magnum Bikes battery may be charged whether it is or is not attached to the e-bike.

Locate the charge port/charge port cover. The charge port is on the bottom left of the battery.

Pull the rubber charge port cover to the side.

Plug the approved charger into a power source.

Using the charger that was provided with the Vertex, align the pin in the battery/charger connector with the battery's charge port. Do not force the charger pin into the charge port. The pin should smoothly slide into the port.

The indicator light on the charger will light up red when the battery is charging.

The battery has reached full charge when the charger's indicator light turns to green.

Disconnect the battery from the charger when the battery has reached a full charge.

Unplug the charger from the power source when the charge is no longer in use.

## 5.4 Pedal Installation

### INFO

It is important to install the pedal onto the corresponding crank arm. Improperly installing the pedals can damage the pedals, the crank arms, or both.

Identify whether the pedal goes on the left side or right side. Some pedals will have an "L" or "R" stamped on the pedal to indicate whether it is a left side or right side pedal. The direction of the spindle threads will also indicate whether the pedal is left or right side.

Tighten the right-side pedal by turning clockwise. Tighten the left-side pedal by turning counterclockwise.

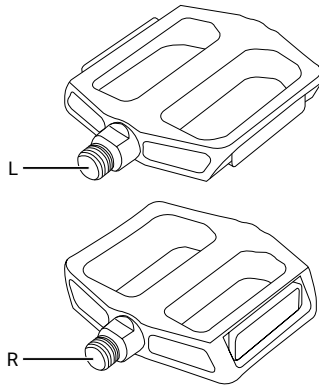
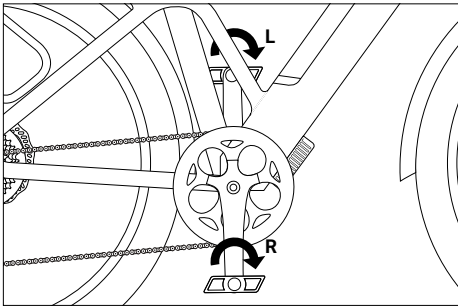

### CAUTION

Use a 15mm wrench to tighten pedals to crank arms. Using an incorrect sized wrench may damage the pedal spindle. Using the improper tool may not fully secure the pedal to the crank arms. An improperly installed pedal may lead to injury.

## 5.5 Warnings

### WARNING

Incorrect assembly, maintenance, or use of your Vertex can cause component or performance failure, loss of control, serious injury, or death. Even if you're an experienced bike rider, you must read and understand the entire manual and any documentation provided for subcomponents or accessories before riding. If you are not sure you have the experience, skills, and tools to correctly perform all assembly steps in the manual and the assembly video, consult a certified and reputable bike mechanic.

To reduce the risk of injury, close supervision is necessary when the product is used near children.

### If your bicycle sustains an impact:

Should you be injured in the impact, check yourself for injuries and take the proper actions needed to attend to any injuries. Seek medical help if necessary.

After any crash, take your bike to your dealer for a thorough damage inspection.

### WARNING

A crash or other impact can put extraordinary stress on bicycle components, causing them to fatigue prematurely. Components suffering from stress fatigue can fail suddenly and catastrophically, causing loss of control, serious injury, or death.

## 6. Storage

### 6.1 Battery Storage

Store the bike in a location where it is protected from extreme elements like snow, rain, or direct and unfiltered sunlight. Snow, rain, road salts, and ice inhibiting chemicals can cause parts to degrade and corrode. The UV rays from the sun can fade the paint and can cause rubber and plastic parts to dry, become porous, and/or crack. Apply sunscreen and wear a hat when in direct sunlight.

### 6.2 Bike Storage

Should the bike be in disuse for an extended period of time, it is best to care for and store the e-bike.

Separate the battery and the e-bike. The e-bike should be stored indoors, in a covered environment. The temperature range for the e-bike, separated from the battery, can be between 35°-70°F (2°-21°C). The battery should be stored indoors at room-temperature.

If your battery is unused for several months it is possible that it may fall into sleep mode. It is recommended to check the charge at least once a month while not in use. It is recommended to maintain a charge between 40-80% while in storage.

Should the battery fall into "sleep mode" the battery should be taken to an authorized Magnum Bikes dealer.

## 7. Maintenance

### WARNING

Though this manual is to be used as a reference point, it is impossible for this manual to provide all the information required to properly repair and maintain your bicycle. To help minimize the chances of injury, it is critical that you have any repair or maintenance which is not specifically described in this manual performed by your dealer. Equally important is that your individual maintenance requirements will be determined by everything from your riding style to geographic location. Consult your dealer for help in determining your maintenance requirements.

## ⚠ WARNING

Many bicycle service and repair tasks require special knowledge and tools. Do not begin any adjustments or service on your bicycle until you have learned from your dealer how to properly complete them. Improper adjustments or service may result in damage to the bicycle or in failure which can cause serious injury or death.

Keeping a regular maintenance and cleaning schedule will optimize the performance and safety of your e-bike. Follow the instructions in this manual as a foundation for how to maintain your e-bike. Consult your Magnum dealer for further advice and recommendations on maintenance, cleaning, tools and materials to keep your Magnum Bike operating at its fullest.

Routinely check the condition of your bicycle before every ride. Make sure nothing is loose. Lift the front wheel two or three inches off the ground, then allow it to bounce on the ground; listen for anything that sounds loose. Do a visual and tactile inspection of the whole bike. Secure any loose parts or accessories. If in doubt, seek the assistance of a qualified bicycle mechanic.

### After every 10 to 20 hours of riding:

Check the brake pads for wear. It will be time to replace the brake pads when pad material measures less than 1mm thick.

Inspect cables, housing, and electrical wires for rust, kinks or fraying. Replace any damaged parts.

Check tires for excess wear, cuts or damage. Replace tires if necessary.

Check the wheel rims for dents, scratches and material bending. Consult your dealer if any damage is found.

Ensure that all parts and accessories are secured. Tighten any parts and accessories that are not properly secured.

Check the frame, particularly in the area around all tube joints, the handlebars, the stem, and the seatpost for any deep scratches, cracks or discoloration. These are signs of stress-caused fatigue and indicate that a part is at the end of its useful life and needs to be replaced.

## ⚠ WARNING

Different materials and metals wear or fatigue from stress at different rates and have different life cycles. If a component's life cycle is exceeded, the component can suddenly and catastrophically fail, causing serious injury or death to the rider. Scratches, cracks, fraying and discoloration are signs of stress-caused fatigue and indicate that a part is at the end of its useful life and needs to be replaced. While the materials and workmanship of your bicycle or of individual components may be covered by a warranty for a specified period of time by the manufacturer, this is no guarantee that the product will last the term of the warranty. Product life is often related to the kind of riding you do and the treatment to which you subject the bicycle. The bicycle's warranty is not meant to suggest that the bicycle cannot be broken or will last forever. It only means that the bicycle is covered subject to the terms or the warranty. Please be sure to read the sections covering the intended use of your bicycle.

## ⚠ WARNING

Once a crack develops, it can and will continue to grow if the e-bike is continued to be used. Any crack that is discovered is potentially dangerous and will only become more dangerous. Do not continue to use the e-bike once a crack is discovered.

## ⚠ WARNING

Do not ride an e-bike with any crack, bulge or dent, even a small one. Riding a cracked frame, fork, or component could lead to complete failure, with risk of serious injury or death.

Ensure that the brakes and their system components are free from damage, properly secured, and working correctly. When brakes are fully squeezed, both front and rear brake levers should not be touching the handlebar. Take your bike to a certified and reputable bike mechanic to have the brakes repaired if you find a problem.

If the chain is not shifting smoothly and easily from gear to gear, the derailleur is out of adjustment. Consult your dealer.

### Tires and Wheels:

Ensure that both front and rear tires are inflated to the correct tire pressure. The correct tire pressure is embedded on the sidewalls of the tires.

Inspect both tires for cuts or damage to the sidewalls and treadings. Replace damaged tires before riding the bike.

Spin each wheel and watch for side-to-side wobble. If a wheel wobbles side to side even slightly, take the bike to a qualified bike shop to have the wheel trued.

## ⚠ CAUTION

Wheel truing is a skill which requires special tools and experience. Do not attempt to true a wheel unless you have the knowledge, experience, and tools needed to do the job correctly.

**Brakes: Check both the front and rear brakes for proper operation.**

Squeeze the brake levers. The brakes should begin to engage within an inch of brake lever movement.

The brake levers should apply full braking force without the levers having to touch the handlebar.

Do not ride the bike if the brakes are not properly adjusted and in proper working condition.

### 7.1 Cleanings

With a mixture of water and neutral cleaning solution, use a soft cloth or brush to wipe off dirt, dust, and grit from the exposed surfaces. Rinse soapy residue off with water. Wipe dry with a clean soft cloth.

## ⚠ CAUTION

Do not use high-pressure water or air hoses for cleaning. It can force water and other contaminants into greased bearings and/or sealed electrical components, which may cause failure, malfunctions, or defects.

## ⚠ CAUTION

Do not use an excessive amount of water when washing the e-bike. Water may reach internal electrical components, possibly causing components to fail or other problems.

## ! NOTICE

Do not use cleaning solutions that are non-neutral. Using a solution that is too strong may cause necessary greases and lubricants or other essential materials to degrade, deteriorate, distort, or irreversibly transform.

### 7.2 Drivetrain

After every long or hard ride; if the bike has been exposed to water or grit; or at least every 100 miles: Clean the bike and lightly lubricate the chain's rollers with a good quality bicycle chain lubricant. Wipe off excess lubricant with a lint-free cloth. Lubrication is a function of climate. Talk to your dealer about the best lubricants and the recommended lubrication frequency for your area.

## 8. Legal

### 8.1 Warranty

At Magnum Bikes we believe that the safety and enjoyment of the rider is the top priority. To fully maximize the experience, we believe that the rider should only focus on the ride and the journey, without worry or concern about the quality and durability of their e-bike. Magnum Bikes offers a worry-relief warranty on all of our bikes, parts, and accessories.

### Magnum Bikes - One Year Limited Warranty

Magnum Bikes warrants that all new Magnum Electric Bicycles and main components therein sold by an authorized Magnum Bikes retailer are warranted to the original retail purchaser against manufacturing defects in materials and/or workmanship for a period of one (1) years from the date of original retail purchase. Warranty Registration must be filled out no later than 90 days from the date of purchase, or the warranty may be void.

This warranty pertains to any of the essential electric bicycle components that are found defective; provided that the product was used in a standard and controlled manner, and that it was maintained according to the manufacturer's instructions manual. Essential components include the bicycle frame, electric motor, battery, display console, and controller.

If a defective part is found during the warranty period and the customer notifies us immediately, the seller will repair or replace the part based on his sole discretion. This warranty will be void if any repair or change is performed by any third party aside from an authorized dealer or service center.

It is expressly agreed that this warranty applies only to the cost of repair or replacement of the product and its accessories and the seller is not liable for any financial loss and/or prevention of profit and/or any consequential loss that may be caused by non-standard usage of the product. We hereby inform the buyer that Magnum Bikes is not responsible for any liability that may occur which could possibly apply to the product and/or its user due to the usage of the product and that the customer alone is solely responsible for third party insurance and/or other insurance as required by the nature of the particular product. The seller is not responsible for any possible damage including bodily harm and damage to property. The warranty does not apply if any part of the product is damaged as a result of negligence, an accident, or inadequate maintenance. This warranty gives you specific legal rights, and you may also have other rights which vary from state to state.

**As mentioned above this warranty does not apply to the tire, spokes, brakes, rims, and other mechanical components of the bicycle.**

**To fulfill a warranty request, you must fill out the form found under "Warranty Registration" at magnum-bikes.com. You must fill out every field in the form and include pictures of the issue.**

### This warranty does not cover:

Normal wear and tear

Damage or failure due to negligence, misuse, accident, or abuse

Cosmetic scratches or non-structural blemishes

Improper or incorrect maintenance

Improper or incorrect assembly

Installation of parts, components, or accessories not compatible or intended for the e-bike as sold

Labor charges for part replacement or changeover

Non-proprietary parts covered by the original manufacturer's warranty

Corrosion

Suspension fork

Using electrical components or chargers not approved by Magnum Bikes

Bikes used for commercial activities, including those in rental, demo, or security fleets.

### Credit Card Chargeback

If the Vertex or any other Magnum Bikes e-bike should become the subject to a credit card chargeback in any amount, and you are still in possession of the e-bike, then any and all warranties that the e-bike had been covered by shall be invalidated until the credit card chargeback has been resolved.

### Customer Obligations to Maintain Warranty

Do not alter the shape or integrity of frame and/or rack carrier tubings.

**Determining whether damage or defect to an e-bike or covered component is protected by this warranty shall be in the sole discretion of Magnum Bikes.**

### 8.2 Exclusions

Normal wear and tear on parts such as but not limited to chains, cables, tires, gearwheels in situations where there are no assembly or material defects.

Modifications from the original condition

Use of the e-bike in abnormal, commercial and/or competitions or for other purposes other than for which the e-bike was designed.

Damage or neglect caused by failing to follow the user manual.

Paint finish and decal damage resulting from taking part in competitions, jumping, downhill and/or training for such activities or events or as a result of exposing the bike to, or riding the bike in, severe conditions or climates.

### 8.3 Disclaimer

---

Do not tamper with your bicycle. Tampering is removing or replacing any original equipment or modifying your bicycle in any way that may change its design and/or operation. Such changes may seriously impair the handling, stability and other aspects of the bicycle, making it unsafe to ride.

Tampering can void the warranty and render your bike not in compliance with the applicable laws and regulations. To ensure safety, quality, and reliability, use only original parts or Magnum Bikes authorized replacements for repair and replacement. Magnum Bikes is not responsible for any direct, incidental, or consequential damages, including, without limitation, damages for personal injury, property damage, or economic losses due to tampering.

### 8.4 Prop.65

---

## **⚠ WARNING**

This product contains chemicals known to the state of California to cause cancer and birth defects or other reproductive harm.

For more information go to: <https://www.p65warnings.ca.gov>

Email: [info@magnumbikes.com](mailto:info@magnumbikes.com)

Phone: 323-375-2666

Magnum Bikes Help Center



## Stay Connected

@magnumbikes

@magnumelectricbikes

@magnumbikes

@magnumbikes

@magnumbikes

@magnumbikes