

magnum

Nomad



PLEASE READ ME FIRST

www.magnumbikes.com

1. General Introduction

1.1 Welcome 01

1.2 Use of Manual 01

1.3 Service and Technical Support 01

1.4 Bike Components 02

1.4.1 Frame & E-Bike Components 02

1.4.2 Handlebar/Cockpit Components 02

1.5 Technical Data 03

2. Assembly and Adjustment

2.1 Handlebar and Stem Assembly 04 - 06

2.2 Assembly of the Pedals 06 - 07

2.3 Seat Position 08

2.4 Saddle Height 09

2.5 Saddle Adjustment 09

3. Battery and Charger

3.1 Overview 10

3.2 General Remarks 11

3.3 Installing and Removing the Battery 11

3.4 Charging 11

3.5 Ride Range 11

4. Display

4.1 Appearance 12

4.2 Indicators & Buttons 13 - 19

5. Recommendations and Maintenance

5.1 General Requirements 20

5.2 Maintenance Schedule 20 - 21

5.3 Definition of Tampering and Recommendations 22 - 23

6. Warranty 23

1. General Introduction

1.1 Welcome

Thank you for purchasing a Magnum electric bike and welcome to the Magnum Bikes family of e-bike enthusiasts. We encourage you to join our Facebook group "Magnum Bikes Community" which you can find at the following link: <https://www.facebook.com/groups/389290978573773> Our Facebook group is a place for Magnum riders to ask questions, have discussions, share recommendations and experiences and connect with other Magnum Bike enthusiasts.

1.2 Use of Manual

We encourage you to read this manual thoroughly before you take your new E-bike for a ride. It is important not to overlook the safety instructions and explanations of both traditional and non-traditional bike parts, as this will offer you a general understanding of your new E-bike. This manual is designed to help you get the most out of your E-bike, and so we have attempted to answer as many of your potential questions as possible. Please take a moment to read through the various sections before you get in the saddle.

1.3 Service and Technical Support

This manual is intended as a general overview of your new E-bike, and is therefore not an extensive reference. For technical support, including information about service, maintenance and repairs, please consult your local Magnum dealer or our customer support team. You can visit our website (www.magnumbikes.com) for more information about our products and technology, or to find a dealer close to you.

Disclaimer*

Because it is impossible to anticipate every situation or condition which can occur while riding, this manual makes no representations about the safe use of bicycles under all conditions. There are risks associated with the use of any bicycle which cannot be predicted or avoided, and which are the sole responsibility of the rider. You should keep this manual along with any other documents that were included with your bicycle. All content in this manual is subject to change without notice. Magnum Bikes makes every effort to ensure accuracy of its documentation and assumes no responsibility of liability if any errors or inaccuracies appear within. Assembly and initial adjustments of your Magnum e-bike requires special tools and skills. It is recommended that this be done by a trained bicycle mechanic if possible.

1. General Introduction

1.4 Bike Components

1.4.1 Frame & E-Bike Components

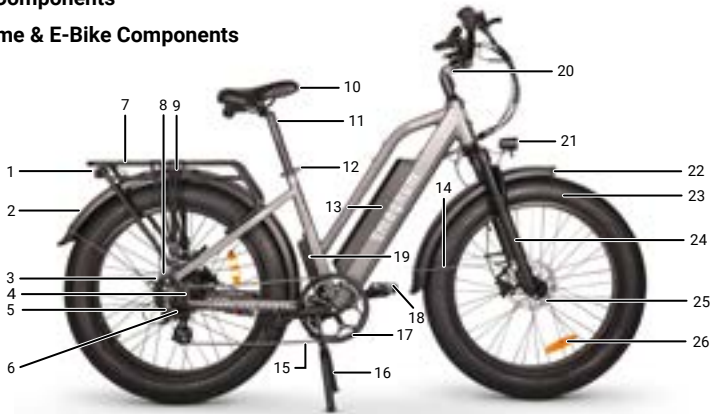

- | | | | |
|------------------------------|--------------------------|---------------------|----------------------|
| 1. Rear Light | 8. Rear Disk Brake | 15. Chain | 22. Front Fender |
| 2. Rear Fender | 9. Bungee Cord | 16. Kickstand | 23. Tire |
| 3. Motor | 10. Saddle | 17. Crankset | 24. Front Fork |
| 4. Freewheel | 11. Seatpost | 18. Pedal | 25. Front Disc Brake |
| 5. Rear Derailleur Protector | 12. Saddle Quick Release | 19. Controller | 26. Wheel Reflector |
| 6. Rear Derailleur | 13. Battery | 20. Adjustable Stem | |
| 7. Carrier | 14. Fender Holder | 21. Front Light | |

1.4.2 Handlebar/Cockpit Components

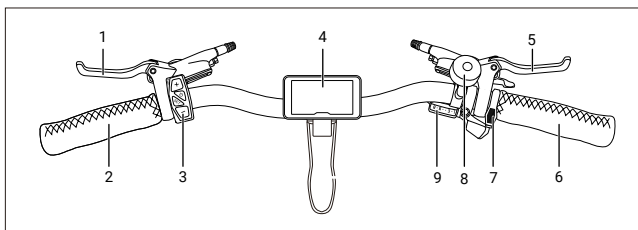

- | | | |
|---------------------|----------------------|----------------|
| 1. Left Brake Lever | 4. Display Screen | 7. Throttle |
| 2. Left Grip | 5. Right Brake Lever | 8. Bell |
| 3. Display Buttons | 6. Right Grip | 9. Thumb Shift |

1. General Introduction

1.5 Technical Data

Component	Nomad
Motor	48V, 750W Bafang Rear Geared Hub Motor
Battery	48V Lithium Ion
Display	Magnum LCD Display
Throttle	Twist
Front Fork	Supsension Fork With Lockout
Crankset	52T 170mm
Brakes	Left/Right: Hydraulic Disc Brakes
Derailleur	Shimano, 7-speed
Freewheel	7-speed
Tires	26" x 4"
Front Light	Integrated With Display
Rear Light	Integrated With Display
Max Loading ¹	260lbs
Max Speed ²	Cadence sensing PAS up to 28mph, throttle up to 20mph
¹ Max load includes the bike	
² Can be configured to class 1, 2, or 3 e-bike	

2. Assembly and Adjustment

2.1 Handlebar and Stem Assembly

NOTICE: The following instructions are only a general guide to assist in the assembly of your e-bike and are not a complete or comprehensive manual of all aspects of assembly, and maintenance of your e-bike. Unless you are experienced with bike mechanics, it is always preferable to have your e-bike assembled and checked by a professional bike shop or mechanic.

Step 1. Unbox the Bike

Open the bike box. With the help of another person capable of safely lifting a heavy object, remove the Magnum e-bike from the bike box. Remove your charger and accessories from the box. Carefully remove all protective packaging including foam, cardboard, and ties, taking care not to scratch your frame with any cutting device.

Step 2. Remove the Stem Faceplate

Use 4mm hex key to remove all four stem faceplate bolts. Remove the faceplate and set it to the side.

Step 3. Attach the Handlebar

Place the handlebar on the stem in the correct position. Center the handlebar, put the faceplate back in place and screw in the four stem faceplate bolts evenly. *Note: Do not tighten all the way down for further adjustment later in assembly.



Step 4. Install the Front Fender & Headlight

Slide the fender through the front fork above the tire. Use a 4mm hex key on the bolt and 10mm box wrench on the nut to tighten the attachment points to the silver fender holder.

Find the front light that comes separate in the bike box. It should be attached to a cord. Use a 5mm hex key and 15mm box wrench to tighten the front light attachment points and then connect the cord.



Step 5. Install the Front Wheel

NOTE: This step is easier with two people, one to lift and hold the bike so that the other can install the front wheel in to the fork.

Remove the plastic insert from the fork dropout and find the quick release skewer that came separate in the bike box. Move the front wheel between the front fork until the fork dropout (notches) are in place on the wheel axle - making sure the brake rotor sits in between the braking pads in the brake caliper. The flat washer on the axle should sit outside the fork dropout.

Put the quick release skewer through the axle and tighten the nut until the quick release lever begins having resistance at the halfway closed point. Once the front wheel is securely installed, prop the kickstand down to hold up the bike.



Step 6. Adjust the Stem Angle & Height

Use a 5mm hex key to loosen the side bolt and then a 5mm hex key to loosen the underside bolt. Adjust the stem angle to your preferred height and then tighten the bolts.

Step 7. Check Stem

Stand in front of the bike and clamp the front wheel with both legs. Verify the handle bars are straight and perpendicular to the front wheel. Then make sure that the pinch bolts are tight and you can not turn the stem freely from the front wheel (meaning the stem should not twist separate from the front wheel, they should only twist together).

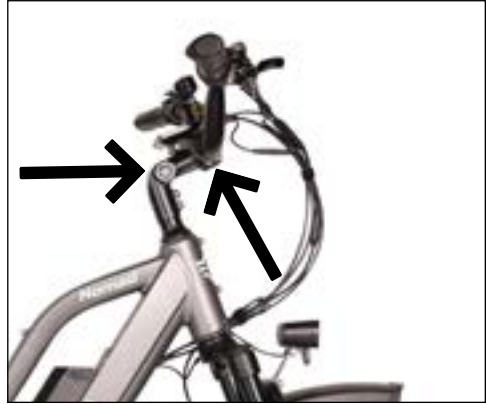

Step 8. Adjust the Handlebar & Display

Sit on the saddle and rotate the handlebar to your desired position. Then fully tighten the four face-plate screws to secure it. Loosen the screws on the display mount to adjust the angle. Tighten the screws to secure the display mount in place. The angle of the display itself can also be adjusted.



2. Assembly and Adjustment

2.2 Assembly of the Pedals

Step 9. Install Pedals

The left and right pedal are marked on each end to differentiate. NOTE: It's best to grease the pedal threads before installation. To install the pedals on the crank arms tighten the right pedal clockwise, and left pedal counterclockwise. NOTE: Left and right are the same sides as when you are riding the bike, not facing it.

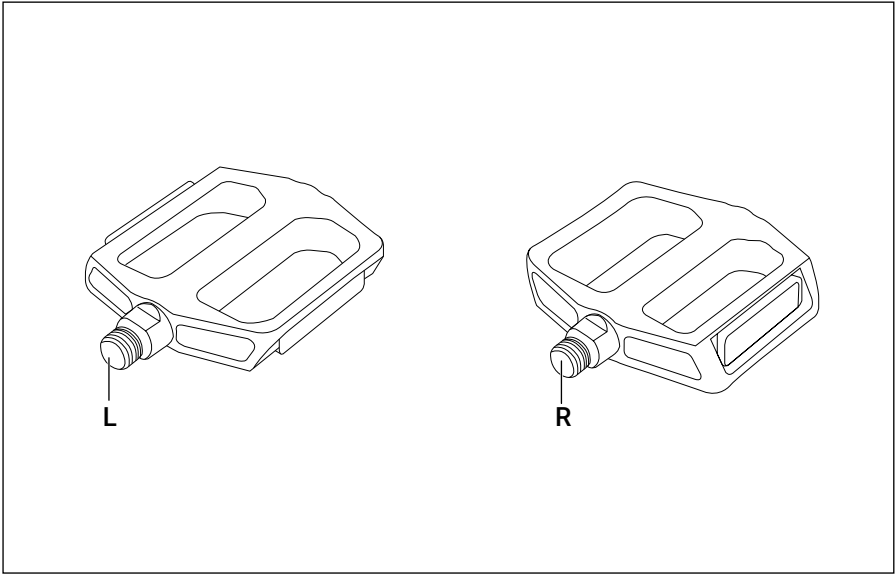

2. Assembly and Adjustment

2.3 Seat Position

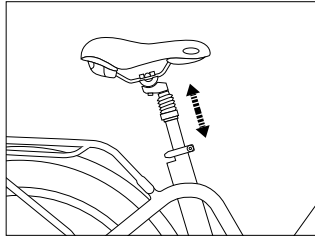

To enable comfortable, fatigue-free and safe riding, the saddle and handlebar height should be adjusted to the body size of the rider.

The saddle height is correct if the leg is near full extension while the foot is resting flat on the pedal in the bottom position of the crank cycle. The toes must still be able to touch the ground comfortably.

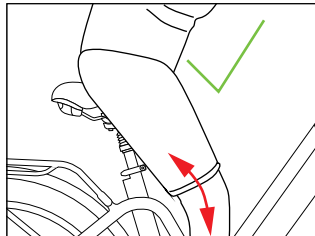
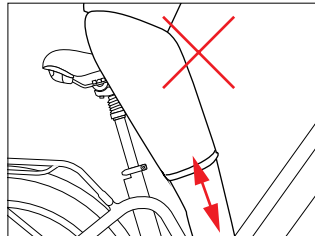
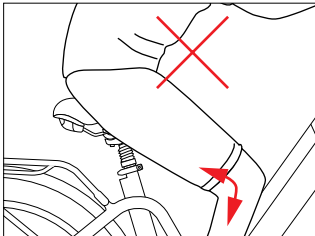

Optimal

2. Assembly and Adjustment

2.4 Saddle Height

The quick-release lever must require noticeable effort to put into fully closed position to prevent any undesired movement while riding.

⚠ WARNING

An improperly closed quick release lever can open again or have limited ability to keep the saddle in place. This may cause the saddle to suddenly drop into the seat tube, potentially leading to serious falls and injury.

There is a minimum insertion line marked on the seat post (failure to observe the minimum insertion line can result in serious injury); please ensure the seat post is always inserted into the seat tube beyond this line (the line must be inside the seat tube).

Loosen the quick release lever at the top of the seat tube, determine the appropriate saddle height and tighten the clamp.

The clamping force can be adjusted by adjusting the bolt on the quick release lever.

The quick release lever must be closed with considerable counter pressure.

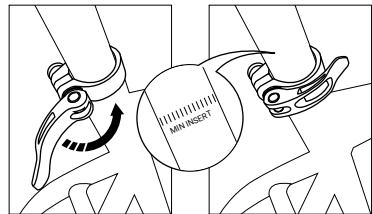

2. Assembly and Adjustment

2.5 Saddle Adjustment

The saddle can also be tilted and adjusted in the forward/back direction.

Loosen the bolt at the bottom (4).

Adjust the saddle tilt by pressing down on the front or rear of the saddle

Move the saddle forward or backward to adjust for arm/torso length and desired riding position.

Tighten the bolt (4) to secure the saddle.

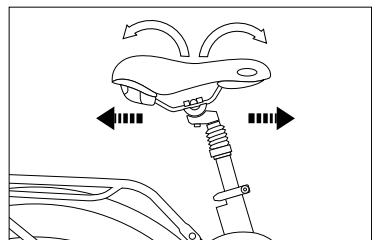

3. Battery and Charger

3.1 Overview

Battery

- A Battery
- B Charging Socket
- C Battery Handlebar
- D Capacity Level Light
- E Power Button
- F USB Port

Charger

- A AC Plug (type will vary)
- B Charger
- C Charging Indicator
- D Battery Plug

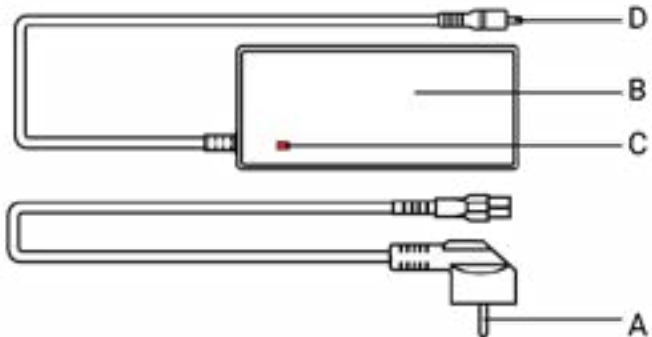
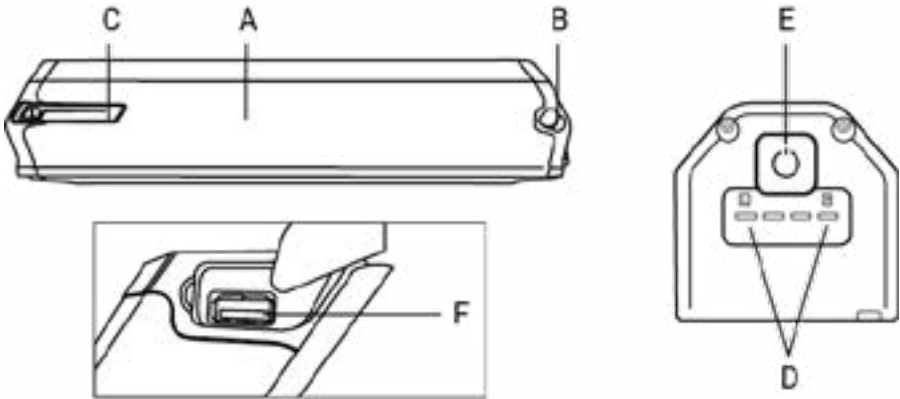

3.2 General Remarks

Stop charging the battery immediately if you notice anything unusual, such as smoke or a strange smell; take out the battery and store it outside of the house, then take the battery to an authorized dealer or experienced technician for service or replacement.

In the unlikely case that the battery catches fire, do NOT attempt to put it out with water. Use sand or another fire retardant instead and call emergency services immediately.

3.3 Installing and Removing the Battery

The battery (1) is secured with a lock. Unlock the battery using the key and pull in with handle (2). Insert the battery (1) into the frame until it stops or clicks. Remove the key from the lock (3) and insure it is secure.

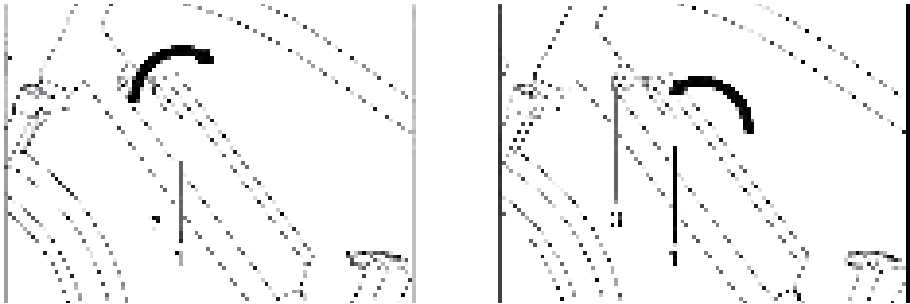

3.4 Charging

Charging at temperatures below 32°F (0°C) or above 140°F (60°C) can cause the battery to charge insufficiently and can be harmful to the life of the battery

During charging, the charger's LED light will be continuously red

Charging is completed when the charger's LED turns green

3.5 Ride Range

Stop charging the battery immediately if you notice anything unusual, such as smoke or a strange smell; take out the battery and store it outside of the house, then take the battery to an authorized dealer or experienced technician for service or replacement.

In the unlikely case that the battery catches fire, do NOT attempt to put it out with water. Use sand or another fire retardant instead and call emergency services immediately.

4. Display

4.1 Appearance

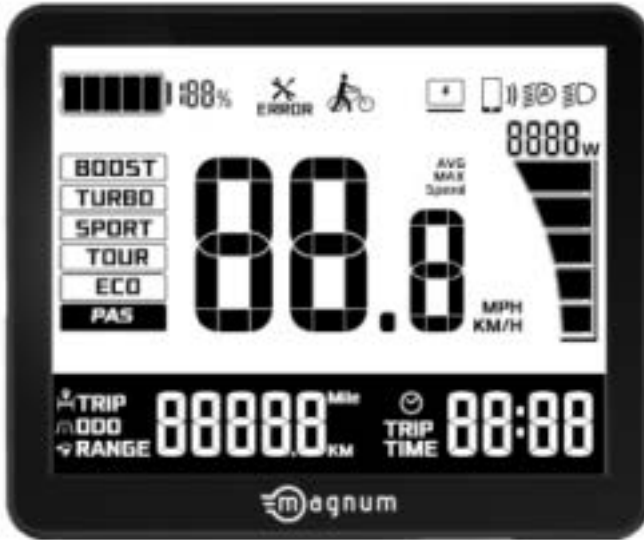

Powering ON/OFF

Press and hold the power button to turn on the display. A start-up screen (see image below) will display for approximately 2 seconds before entering the main interface showing real-time information.

To turn the display off press and hold the power button until the screen goes blank. The display will turn off automatically if no operations are performed within the set sleep time, while the speed is 0, and current is less than 1A. The sleep time can be set by the user in the settings interface.



Start-up Screen

Main Interface

4. Display

4.2 Indicators & Buttons



Button Functions

Power On: Turns the display on/off

Adjust Up/Down: Changes the level of pedal assist during riding and switches functions in display settings

Mode Function: Switches interface functions and enters into the display settings

4.Display

Pedal Assist Level

Short press the arrow buttons to adjust the pedal assist level up or down. There are 5 PAS levels: ECO, TOUR, SPORT, TURBO, BOOST, and BOOST+. BOOST+ is indicated by a blinking BOOST icon. When PAS level is empty it means pedal assist is off.

PAS levels do not switch in cycles. Meaning, after reaching the BOOST level pressing the up arrow will NOT cycle the levels back to the beginning. The user must use the down arrow button to switch back down to PAS off.

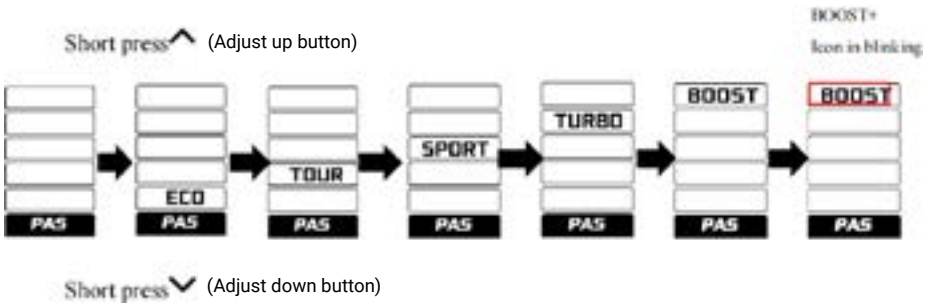

4.Display

Trip, Odometer, & Range

Short press the M button to switch from TRIP, ODO, & RANGE on the display. The cycle order is TRIP/AVG, ODO/MAX, then RANGE/AVG. After 5 seconds with no operation performed on the M button and the bike speed greater than 0 the display screen will switch back to the main interface. The symbols below will indicate which value is being shown.



Light Control

Long press the adjust up button to turn the headlight on and off. While the headlight is on the display's backlight is dimmed.

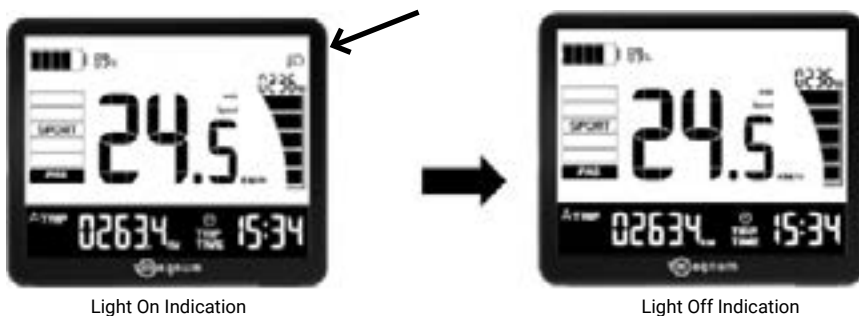

Light On Indication

Light Off Indication







Speed Indication

The standard readout is real time speed, and can be switched to show average speed (AVG), and maximum speed (MAX).

How to change speed readout...

Battery Power

Battery power is shown by a battery bar indicator and percentage. The battery bar divides the power level into 5 bars. After battery capacity is lower than 5% the display enters low voltage mode. In this mode the battery level shows 0 bars. The battery outline will start blinking after reaching 1Hz, and with no power output from the motor, pedal assist will be disabled. The PAS level is displayed as OFF or 0. To get out of low voltage mode the battery will need to be charged.

SOC	Battery level	Description
80% ≤ SOC		Full battery level 5
60% ≤ SOC < 80%		Level 4
40% ≤ SOC < 60%		Level 3
20% ≤ SOC < 40%		Level 2
10% ≤ SOC < 20%		Level 1
5% ≤ SOC < 10%		Level 0
0% ≤ SOC < 5%		Level 0 and icon blink at 1Hz

Walk Mode

When speed is below 3mph long press and continue to hold the adjust down (down arrow) button to enter walk mode. Upon entering walk mode the display will show a walk mode symbol and the real-time speed while the PAS level displays as off (see image below). Release the adjust down button to exit walk mode. The motor is turned off and the display returns to the main interface.



Display Settings





The following description explains how users can access the settings options in their display.





Within 10 seconds of turning on the display, long press the M button to enter the settings interface.

Short press the arrow buttons to switch between settings. Short press the M button to enter a specific setting. The selected setting will blink. Short press the arrow buttons to find the setting option you want then long press the M button to set the option. Long press the M button again to exit to the previous page.

In settings short press the M button to enter the next level menu and long press the M button to exit and return to the previous level menu.

Descriptions of individuals settings to follow:

Setting items	Interface	Description	Setting data	Remark
Unit setting		UNT=Unit	Value=KM/H MPH	Default Value=KM/H KM/H—Metric MPH—Imperial
Backlight level setting		bLG=Back light	Value= LEVEL1, backlight level 60% Value= LEVEL 2 backlight level 80% Value= LEVEL 3 backlight level 100%	Default Value= LEVEL 1
Auto shutdown time		SLP= Auto sleep	Value=0-30 min	Default Value=5min OFF means no auto shutdown
Real time clock		N/A	N/A	 Hour: minutes

Software version info		DPS [®] Display software version	Read only	Default fix value
Advanced setting interface		SET=setting	Enter with passcode	#For entering advanced setting items
--Advanced setting sub-level parameter interfaces:				
Speed limitation setting		SPd=Speed limitation	Value [#] PAS 3/4/6	Default: PAS 6 PAS 3= Pedal assist 3 levels, Speed limit 16MPH, PAS 4= Pedal assist 4 levels, Speed limit 20MPH, PAS 6= Pedal assist 6 levels, Speed limit 28MPH
Wheel diameter setting		dia=Wheel diameter	Value= 16, 20, 24, 26, 27, 27.5, 28, 700C, 29, (default unit, inch)	Default: Value [#] 26
System voltage setting		Vol [#] system voltage	Value=36/48V	Default: 48v

Data Clearance

Whithin 10 seconds of turning on the display, when the display shows the TRIP interface, long press the M button to show TRIP data. While the TRIP icon is blinking short press the M button to confirm data clearance. To exit long press the M button. After clearance the subtotal mileage TRIP is 0, average speed is 0, and max speed is 0. ODO information can not be cleared manually on the display.



Error Code Table

Each error code corresponds to a specific fault in the system. The table below is intended for the e-bike owner to use as reference when working with Magnum Bikes technical support or a certified Magnum dealer.

Error Code	Definition	Suggestion
"0x20" shown at speed	Failure of controller	Check controller
"0x22" shown at speed	Failure of throttle	Check throttle
"0x23" shown at speed	Failure of motor's phase wire	Check motor
"0x24" shown at speed	Failure of the motor's hall	Check controller
"0x30" shown at speed	Communication failure	Check connector to controller

If you still have some questions about the display, please contact your Magnum dealer.

5. Recommendations and Maintenance

5.1 General Requirements

E-bikes use metal shells to cover the electric components, so we strongly advise against the use of excessive water to wash the shells and parts around them. Use a soft cloth with a neutral solution to wipe the dirt off the shells. Afterward, wipe everything dry with a clean soft cloth.

Do not use high-pressure water or air hoses for cleaning; this can force water into electrical components, which may cause malfunctioning.

Do not wash plastic components with excessive water. When the internal electrical parts are affected by water the insulator may corrode, leading to power-drain or other problems.

Do not use soap solutions to wash the metal components. Non-neutral solutions may cause discoloration, distortion, scratching, etc.

Avoid leaving the bike outdoors

When not riding, keep the bike in a location where it will be protected from snow, rain, sun, etc. Snow and rain can cause the bike to corrode. Ultraviolet rays from the sun can cause unnecessary fading of paint or crack any rubber or plastic on the bike.

Recommended Torque Values		
Handlebar	18-20 Newton Meters	13.3-14.7 ft·lb
Stem	18-20 Newton Meters	13.3-14.7 ft·lb
Saddle	18-20 Newton Meters	13.3-14.7 ft·lb
Front Wheel	16-25 Newton Meters	11.8-18.4 ft·lb
Rear Wheel	35-40 Newton Meters	25.8-29.5 ft·lb
Bottom Bracket Parts	35-55 Newton Meters	25.8-40.5 ft·lb
Pedals	35 Newton Meters	25.8 ft·lb
Rotor Bolts	6 Newton Meters	4.4 ft·lb
Disk Caliper Mount	10 Newton Meters	7.3 ft·lb
Crank Bolts	40 Newton Meters	29.5 ft·lb
Rear Derailleur Cable Pinch	6 Newton Meters	4.4 ft·lb
Front Derailleur Clamp	7 Newton Meters	5.1 ft·lb
Saddle Post Clamp	7 Newton Meters	5.1 ft·lb

5.2 Maintenance Schedule

To keep your E-bike in optimal condition and your riding experience at its most enjoyable, we strongly recommend following the suggested maintenance schedule. You should study it and allow it to become second nature to your riding.

Maintenance Schedule	Each Ride	Weekly	Monthly	6 Months	Yearly
Tire Pressure	X				
Tire Condition	X				
Visual Inspection	X				
Brake Lever Pressure	X				
Quick Releases	X				
Handlebar Alignment	X				
Saddle Alignment	X				
Battery Pack Locked	X				
Wheel Check	X				
Inspect Frame Condition ¹		X			
Clean & Lubricate Chain		X			
Check Brake Pads		X			
Lubricate Forks			X		
Lubricate Brakes & Cables			X		
Lubricate Folding Mechanism			X		
Check all Bolts & Torque Settings			X		
Clean Bicycle			X		
Charge Battery			X		
Check Heel Spokes			X		
Inspect Rim Condition			X		
Inspect Saddle, Rails & Clamp			X		
Grease Pedal Bearings				X	
Check Hub Bearings				X	
Check Headset Bearings				X	
Check Bottom Bracket Bearings				X	
Replace Brake Pads					X
Replace Brake Cables ²					X
Replace Tires ²					X

¹include welds for fissures, ²depends on use

Warning

As with all mechanical components, electrically power assisted cycles (EPAC) are subjected to wear and high stresses. Different materials and components may react to wear or stress fatigue in different ways. If the design life of a component has been exceeded, it may suddenly fail, possibly causing injuries to the rider. Any form of crack, scratches or change of coloring in highly stressed areas indicate that the life of the component has been reached and it should be replaced.

5.3 Definition of Tampering and Recommendations

Category 1			
Components which can only be replaced after approval from the bicycle manufacturer/ electronic system provider			
Motor	Controller	Electric Cables	Battery
Sensors	Controls on the Handlebar	Display	Battery Charger

Category 2			
Components which can only be replaced after approval from the bicycle manufacturer			
Frame	Hubmotor Wheel	Brake Shoe	Bottom Bracket
Fork ⁹	Brake System	Luggage Carrier	

Category 3			
Components which can only be replaced after approval from the bicycle or component manufacturer			
Cranks	Wheel without Hub Motor	Tires ³	Brake System ⁴
Chain Belt ¹	Rim Tape	Mechanical Brake Cables	Handlebar ⁵
Seat Post Headlight ²	Saddle Headlight ²	Hydraulic Brake Cables	Stem ⁵
¹ at original width			
² maximum variation from original should not exceed 20mm			
³ at original ETRTO specifications only			
⁴ for drum, disc and roller brakes			
⁵ without alterations to the handlebar and stem			

Category 4			
Components which can be replaced without approval			
Headset	Inner Tubes	Shifting Inner & Outer Cables	Kickstand
Pedals ¹	Chainring	Dynamo	Grips ⁴
Derailleurs	Front Light	Cassette Freewheel Cogs ³	Front Reflector
Shifters	Rear Light	Chaincase	Rear Reflector
Mudguards ²	Spokes	Wheel Reflectors	Belt Drive Ring
¹ at the same width as the originals			
² only the same size as the originals and mounted at least 10 mm distance from the tire			
³ when the cogs are the same as the originals			
⁴ only with a screw clamp			

⚠ Warning

Modifications to any part of your bike, such as the fork or frame, may make that part or the entire bike unsafe. A poorly installed or modified component can increase the stress on all other parts, greatly increasing their chance of failure. Modifications can also adversely affect the handling of your bike, resulting in loss of control, falls and serious injury. Please do not add, remove, or modify parts of your bike in any way before consulting with a trained bike technician. We recommend you consult with us at before you make modifications or add parts, in order to confirm their safety and compatibility with your bike.

6. Warranty

Your Magnum E-bike comes with a limited warranty. Please visit www.magnumbikes.com or your local Magnum dealer for details.

Bike must be registered at www.magnumbikes.com/warranty in order to be covered by the one year warranty.

Stay Connected



@magnumbikes



@magnumbikes



@magnumbikes



@magnumbikes



www.magnumbikes.com



@magnumbikes



info@magnumbikes.com



323.375.2666

CE

