

magnum

Pathfinder 500



PLEASE READ ME FIRST

www.magnumbikes.com

1. General Introduction

1.1 Welcome 01

1.2 Use of Manual 01

1.3 Service and Technical Support 01

1.4 Bike Components 01

1.4.2 E-Bike 02

1.5 Technical Data 03

2. Assembly and Adjustment

2.1 Handlebar and Stem Assembly 04

2.2 Assembly of the Pedals 05

2.3 Seat Position 06

2.4 Saddle Height 07

2.5 Saddle Adjustment 07

3. Battery and Charger

3.1 Overview 08

3.2 General Remarks 08

3.3 Installing and Removing the Battery 08

3.4 Charging 08

4. Display 09

5. Recommendations and Maintenance

5.1 General Requirements 15

5.2 Maintenance Schedule 16

5.3 Definition of Tampering and Recommendations 17

6. Warranty 18

1. General Introduction

1.1 Welcome

Thank you for purchasing a Magnum electric bike, and welcome to the Magnum Bikes family of e-bike enthusiasts. We encourage you to join our Facebook group "Magnum Bikes Community". Our Facebook group is a place for Magnum riders to ask questions, have discussions, share recommendations and experiences and connect with other Magnum Bike enthusiasts. You can find the group linked here: <https://www.facebook.com/groups/389290978573773>

1.2 Use of Manual

We encourage you to read this manual thoroughly before you take your new E-bike for a ride. It is essential not to overlook the safety instructions and explanations of both traditional and non-traditional bike parts. So please take a moment to read through the various sections before you get in the saddle.

1.3 Service and Technical Support

This manual is intended as a general overview of your new E-bike, and is therefore not an extensive reference. Please consult your local Magnum dealer or Magnum customer support team for technical support, including information about service, maintenance, and repairs. In addition, you can visit our website (www.magnumbikes.com) for more information about our products and technology or find a dealer close to you.

*Disclaimer

Because it is impossible to anticipate every situation or condition which can occur while riding, this manual makes no representations about the safe use of bicycles under all conditions. There are risks associated with the use of any bicycle which cannot be predicted or avoided, and which are the sole responsibility of the rider. You should keep this manual along with any other documents that were included with your bicycle. All content in this manual is subject to change without notice. Magnum Bikes makes every effort to ensure accuracy of its documentation and assumes no responsibility of liability if any errors or inaccuracies appear within. Assembly and initial adjustments of your Magnum e-bike requires special tools and skills. It is recommended that this be done by a trained bicycle mechanic if possible.

1. General Introduction

1.4 E-Bike

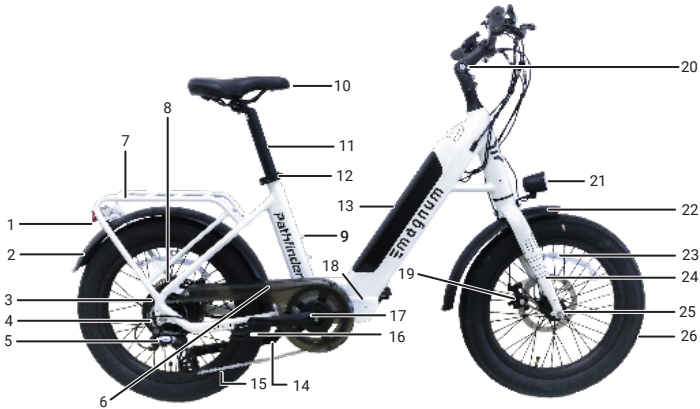

- | | | | |
|--------------------|--------------------------|----------------------|----------------------|
| 1. Rear Light | 8. Rear Disk Brake | 15. Chain | 22. Front Fender |
| 2. Rear Fender | 9. Water Bottle Mount | 16. Pedal | 23. Wheel Reflector |
| 3. Motor | 10. Saddle | 17. Crankset | 24. Front Fork |
| 4. Freewheel | 11. Seatpost | 18. Controller | 25. Dropout + Skewer |
| 5. Rear Derailleur | 12. Saddle Quick Release | 19. Front Disc Brake | 26. Tire |
| 6. Chain Guard | 13. Battery | 20. Adjustable Stem | |
| 7. Carrier | 14. Kickstand | 21. Front Light | |

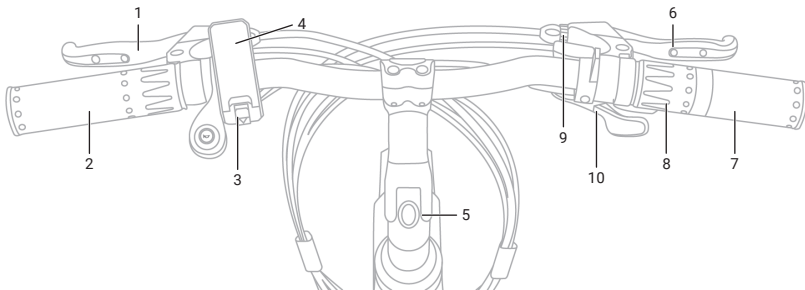

- | | |
|-----------------------|-------------------------|
| 1. Left Brake Lever | 6. Right Brake Lever |
| 2. Left Grip | 7. Right Grip |
| 3. Display Controller | 8. Throttle |
| 4. Display | 9. Bell |
| 5. Adjustable Stem | 10. 8-Speed Thumb Shift |

1. General Introduction

1.5 Technical Data

Component	
Motor	48V, 500W Rear Geared Hub Motor
Battery	48V, 13Ah, 624Wh Li-ncm
Display	Bigstone H102 Display
Throttle	Twist Throttle
Front Fork	Rigid Fork
Brake Levers	Left and Right
Brakes	Hydraulic Disc Brakes
Derailleur	Shimano, Altus, 7-speed
Freewheel	7-speed
Wheel / Tire	20" / 3"
Front Light	Integrated and controlled from the display
Rear Light	Integrated and controlled from the display
Max Loading	265lbs
Max Speed ²	Cadence sensing PAS up to 25mph, throttle up to 20mph
	² Can be configured to class 1, 2, or 3 e-bike

2. Installation and Adjustment

2.1 Handlebar and Stem Assembly

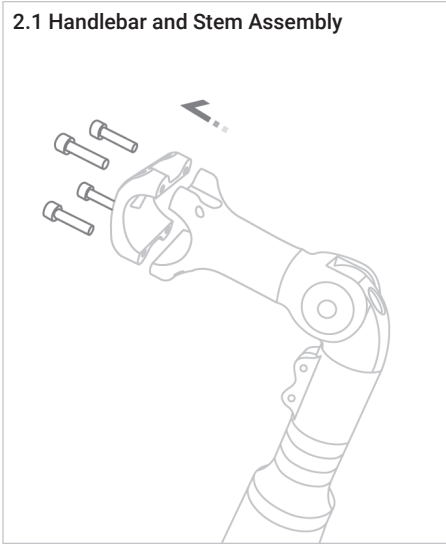

1. Loosen the screws on the faceplate of the stem. Remove the faceplate and set aside.

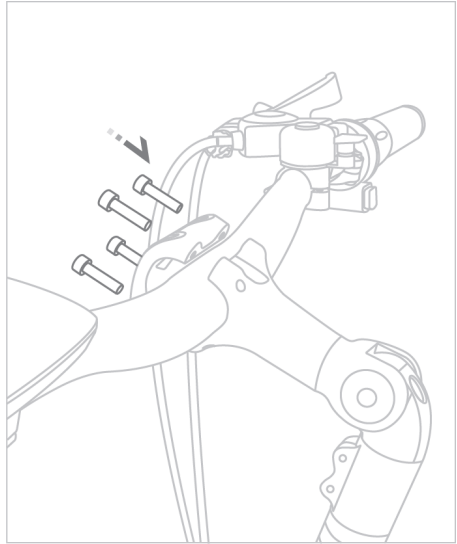

2. Center the handlebar and put the faceplate back in place. Tighten the 4 faceplate screws in a star pattern.

Handlebar & Stem Adjustment

To adjust the angle of your stem loosen the stem bolt (1).

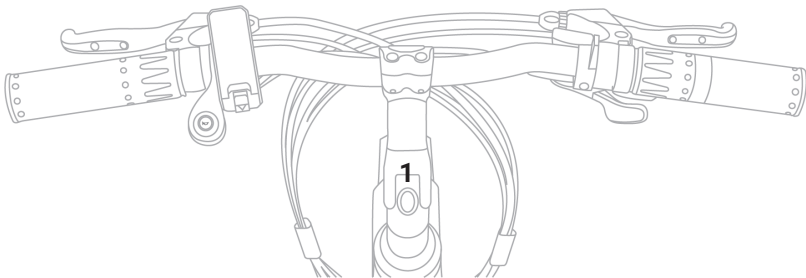

2. Installation and Adjustment

2.2 Assembly of the Pedals

Identify your pedals: check the letters on the pedals, "L" or "R".

Right and left are the same as when you are riding the bike. The "R" and "L" marked pedals are for the right and lefts sides of the bike as if you were riding it.

The "R" marked pedal is for the right, thread it into the crank clockwise and tighten.

The "L" marked pedal is for the left., thread it into the crank counterclockwise and tighten.



WARNING

First screw on the pedals by hand, then tighten with the wrench provided.

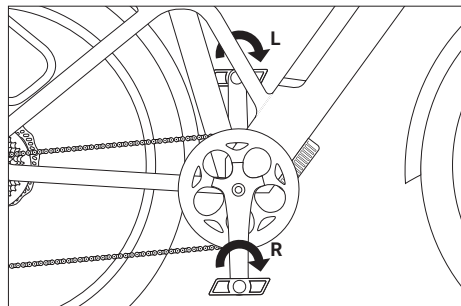
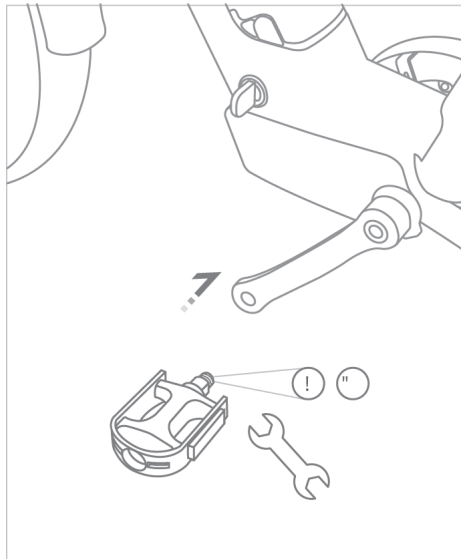

2. Installation and Adjustment

2.3 Seat Position

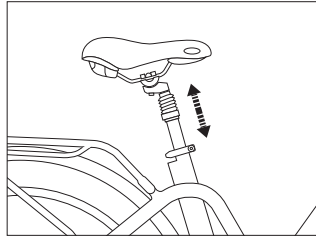

To enable comfortable, fatigue-free and safe riding, the saddle and handlebar height should be adjusted to the body size of the rider.

The saddle height is correct if the leg is near full extension while the foot is resting flat on the pedal in the bottom position of the crank cycle. The toes must still be able to touch the ground comfortably.

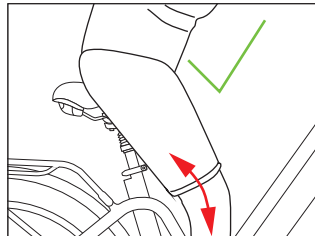
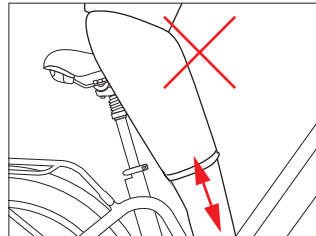
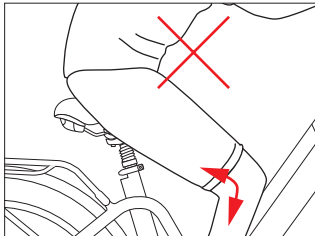

Optimal

2. Installation and Adjustment

2.4 Saddle Height

The quick-release lever must require noticeable effort to put into fully closed position to prevent any undesired movement while riding.

⚠ WARNING

An improperly closed quick release lever can open again or have limited ability to keep the saddle in place. This may cause the saddle to suddenly drop into the seat tube, potentially leading to serious falls and injury.

There is a minimum insertion line marked on the seat post (failure to observe the minimum insertion line can result in serious injury); please ensure the seat post is always inserted into the seat tube beyond this line (the line must be inside the seat tube).

Loosen the quick release lever at the top of the seat tube, determine the appropriate saddle height and tighten the clamp.

The clamping force can be adjusted by adjusting the bolt on the quick release lever.

The quick release lever must be closed with considerable counter pressure.

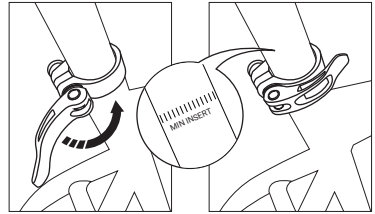

3. Battery and Charger

3.1 Overview

- A Battery
- B Power Button
- C Power Indicator
- D Charging Port

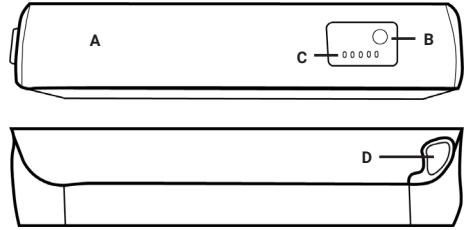

WARNING

Please ensure that the battery is locked in place before use

- A AC Plug¹
- B Charger
- C Charging Indicator
- D Battery Plug

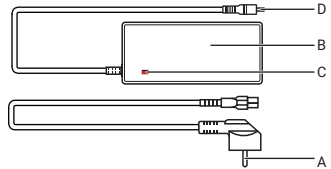

3.2 General Remarks

Stop charging the battery immediately if you notice anything unusual, such as smoke or a strange smell; take out the battery and store it outside of the house, then take the battery to an authorized dealer or experienced technician for service or replacement.

In the unlikely case that the battery catches fire, do NOT attempt to put it out with water. Use sand or another fire retardant instead and call emergency services immediately.

3.3 Installing and Removing the Battery

Turn the lock (2) clockwise to unlock the battery, then grip firmly and pull from the bottom of the battery (1) to remove it from the bike.

Insert the top of the battery into the frame first and then carefully push the bottom of the battery into the frame until it clicks securely into place.

Remove the key from the lock (2). Ensure that the battery is well secured

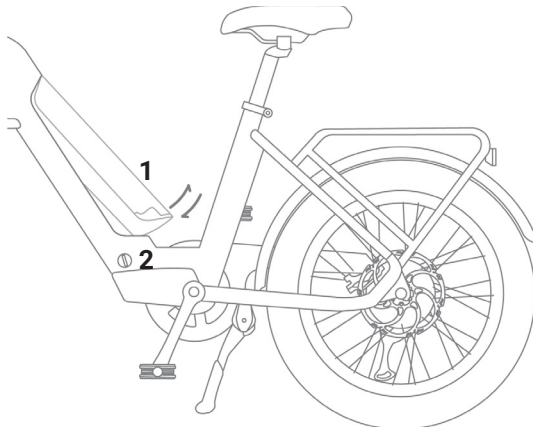

3.4 Charging

Charging at temperatures below 32°F (0°C) or above 140°F (60°C) can cause the battery to charge insufficiently and can be harmful to the life of the battery.

During charging, the charger's LED light will be continuously red.

Charging is completed when the charger's LED turns green.

Do not leave your battery charging overnight.

Please use the original charger or a certified replacement charger from Magnum Bikes.

The charger lights up in red during charging, and turns green when fully charged. Unplug the charger once the battery is full.

Close the rubber charging port on the battery to protect the battery.

4. Display

Appearance



Powering ON/OFF

Press and hold the power button (located above the top of the display screen) to turn on the display.

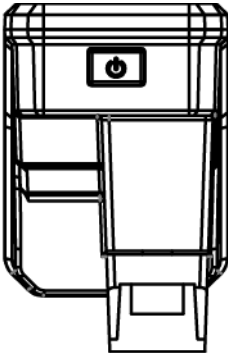

4. Display

Indicators & Buttons

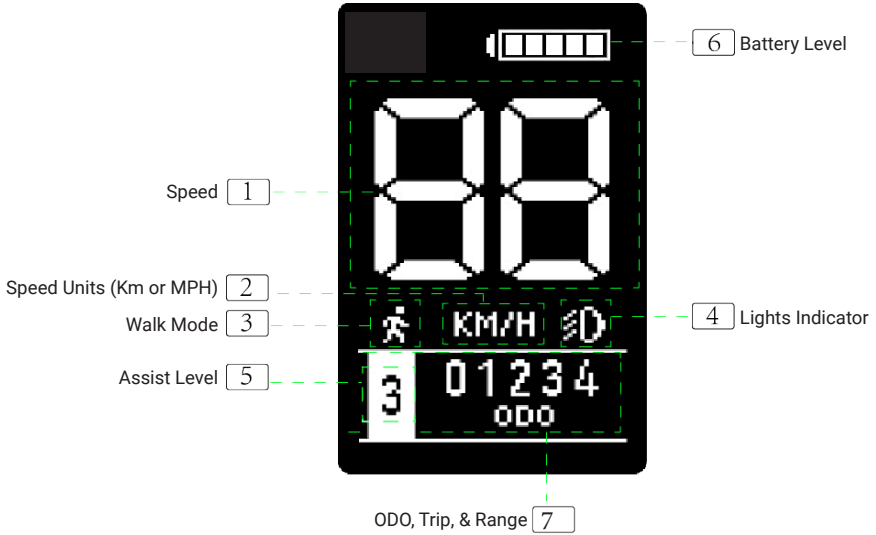

Display Indicators

- 1 Speed of rider
- 2 Speed units chosen in the display settings
- 3 Displays when walk mode is in use
- 4 Displays when the lights are turned on
- 5 Displays the active level of pedal assist
- 6 Shows battery power left
- 7 Indicates if ODO, Trip, or Range is showing



4.Display

Power On/Off

Turn the battery ON, then press and hold the power button to turn the display ON.

Press and hold the power button to turn the display OFF.

Pedal Assist Level

Press the increase arrow button to increase the level of pedal assist.

Press the decrease arrow button to decrease the level of pedal assist.

The level of pedal assist will show on the display as it is increased or decreased by the rider.

The assist levels do not cycle. Meaning that you can increase up to the top level of pedal assist and then must decrease back down to 0 level pedal assist.

Enter/Exit Walk Mode

Press and hold the decrease arrow button to enter walk mode.

The walk mode indicator will appear on the display to show that walk mode is active.

When the decrease arrow button is released walk mode will stop.

Switching Trip, ODO, and Range

While the display is ON and in its regular interface press and release the power button to switch from Trip, ODO, and Range.

4.Display

Display Settings

Enter/Exit The Display Settings Menu

Press the power button and increase arrow button at the time to enter the display settings menu.

Press the power button and decrease arrow button at the same time to exit the display settings menu.



Display Settings Menu Navigation

Use the increase and decrease arrow buttons to move through the display settings menu.

After the menu item is highlighted, press the power button to open the options.

To see the next menu page press the power button when "Page Down" is highlighted.

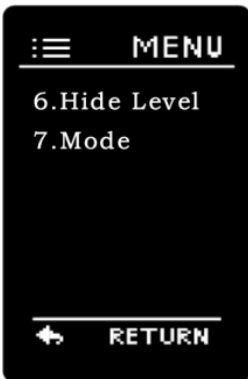

Tire Size

If tire size is not pre-set - select your wheel/tire size and press the power button to set your option.

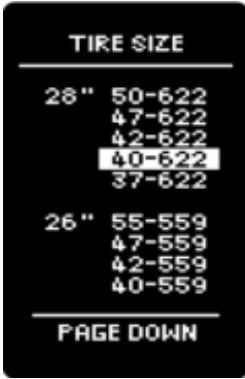

Speed Units

Select km/h or mph and press the power button to set your option.



Top Speed Setting

Top speed is pre-set and can only be adjusted by entering the password. Consult a certified Magnum Bikes dealer or Magnum Bikes customer support if you need further assistance with your speed settings.

Battery Information

Battery information will not show in the display settings on this bike model.

System Version

This option cannot be changed but will display the hardware and software version of the display.



Mode Setting

This setting refers to the pedal assist sensor.

If you have a cadence sensor this setting should be set to "speed".

If you have a torque sensor this setting should be set to "torque".

Magnum "Pathfinder" will come with a cadence sensor. The Magnum "Pathfinder T" will come with a torque sensor. The T stands for torque.



Trip Reset

Press and hold the increase arrow and decrease arrow buttons at the same time for 2 seconds to clear the single trip mileage.

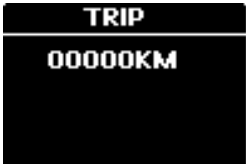

5. Recommendations and Maintenance

5.1 General Requirements

E-bikes use metal shells to cover the electric components, we strongly advise against the use of excessive water to wash the shells and parts around them. Use a soft cloth with a neutral solution to wipe the dirt off the shells. Afterward, wipe everything dry with a clean soft cloth.

Do not use high-pressure water or air hoses for cleaning; this can force water into electrical components, which may cause malfunctioning.

Do not wash plastic components with excessive water. When the internal electrical parts are affected by water the insulator may corrode, leading to power-drain or other problems.

Do not use soap solutions to wash the metal components. Non-neutral solutions may cause discoloration, distortion, scratching, etc.

Avoid leaving the bike outdoors

When not riding, keep the bike in a location where it will be protected from snow, rain, sun, etc. Snow and rain can cause the bike to corrode. Ultraviolet rays from the sun can cause unnecessary fading of paint or crack any rubber or plastic on the bike.

Recommended Torque Values	
Handlebar	8-10 Newton Meters
Stem	8-10 Newton Meters
Saddle	18-20 Newton Meters
Front Wheel	16-25 Newton Meters
Rear Wheel	35-40 Newton Meters
Bottom Bracket Parts	35-55 Newton Meters
Pedals	35 Newton Meters
Rotor Bolts	6 Newton Meters
Disk Caliper Mount	10 Newton Meters
Crank Bolts	40 Newton Meters
Rear Derailleur Cable Pinch	6 Newton Meters
Front Derailleur Clamp	7 Newton Meters
Saddle Post Clamp	7 Newton Meters

5.2 Maintenance Schedule

To keep your E-bike in optimal condition and your riding experience at its most enjoyable, we strongly recommend following the suggested maintenance schedule. You should study it and allow it to become second nature to your riding.

Recommendations & Maintenance

Maintenance Schedule	Each Ride	Weekly	Monthly	6 Months	Yearly
Tire Pressure	X				
Tire Condition	X				
Visual Inspection	X				
Brake Lever Pressure	X				
Quick Releases	X				
Handlebar Alignment	X				
Saddle Alignment	X				
Battery Pack Locked	X				
Wheel Check	X				
Inspect Frame Condition ¹		X			
Clean & Lubricate Chain		X			
Check Brake Pads		X			
Lubricate Forks			X		
Lubricate Brakes & Cables			X		
Lubricate Folding Mechanism			X		
Check all Bolts & Torque Settings			X		
Clean Bicycle			X		
Charge Battery			X		
Check Heel Spokes			X		
Inspect Rim Condition			X		
Inspect Saddle, Rails & Clamp			X		
Grease Pedal Bearings				X	
Check Hub Bearings				X	
Check Headset Bearings				X	
Check Bottom Bracket Bearings				X	
Replace Brake Pads					X
Replace Brake Cables ²					X
Replace Tires ²					X

¹include welds for fissures, ²depends on use

⚠ Warning

As with all mechanical components, electrically power assisted cycles (EPAC) are subjected to wear and high stresses. Different materials and components may react to wear or stress fatigue in different ways. If the design life of a component has been exceeded, it may suddenly fail, possibly causing injuries to the rider. Any form of crack, scratches or change of coloring in highly stressed areas indicate that the life of the component has been reached and it should be replaced.

5.3 Definition of Tampering and Recommendations

Category 1			
Components which can only be replaced after approval from the bicycle manufacturer/ electronic system provider			
Motor	Controller	Electric Cables	Battery
Sensors	Display Controls	Display	Battery Charger

Category 2			
Components which can only be replaced after approval from the bicycle manufacturer			
Frame	Hub-motor Wheel	Brake Pads	Bottom Bracket
Fork	Brake System	Rear Carrier	

Category 3			
Components which can only be replaced after approval from the bicycle or component manufacturer			
Cranks	Wheel without Hub Motor	Tires	Brake System
Chain Belt	Rim Tape	Mechanical Brake Cables	Handlebar
Seat Post	Saddle	Hydraulic Brake Cables	Stem

Category 4			
Components which can be replaced without approval			
Headset	Inner Tubes	Shifting Housing & Cables	Kickstand
Pedals	Chainring	Cassette Freewheel	Grips
Derailleurs	Front & Rear Lights	Wheel Reflectors	Front Reflector
Shifters	Mudguards Fenders	Spokes	Rear Reflector

Warning

Modifications to any part of your bike, such as the fork or frame, may make that part or the entire bike unsafe. A poorly installed or modified component can increase the stress on all other parts, greatly increasing their chance of failure. Modifications can also adversely affect the handling of your bike, resulting in loss of control, falls and serious injury. Please do not add, remove, or modify parts of your bike in any way before consulting with a trained bike technician. We recommend you consult with us before you make modifications or add parts, in order to confirm their safety and compatibility with your bike.

6. Warranty

Your Magnum E-bike comes with a limited warranty. Please visit www.magnumbikes.com or your local Magnum dealer for details.

Bike must be registered at www.magnumbikes.com/warranty in order to be covered by the one year warranty.

Stay Connected



@magnumbikes



@magnumelectricbikes



@magnumbikes



@magnumbikes



www.magnumbikes.com



@magnumbikes



info@magnumbikes.com



323.375.2666

CE

