

# JONR

Cordless wet & dry vacuum cleaner (Wireless intelligent floor washer)

## Use Manual

**ED10**

**ED11**

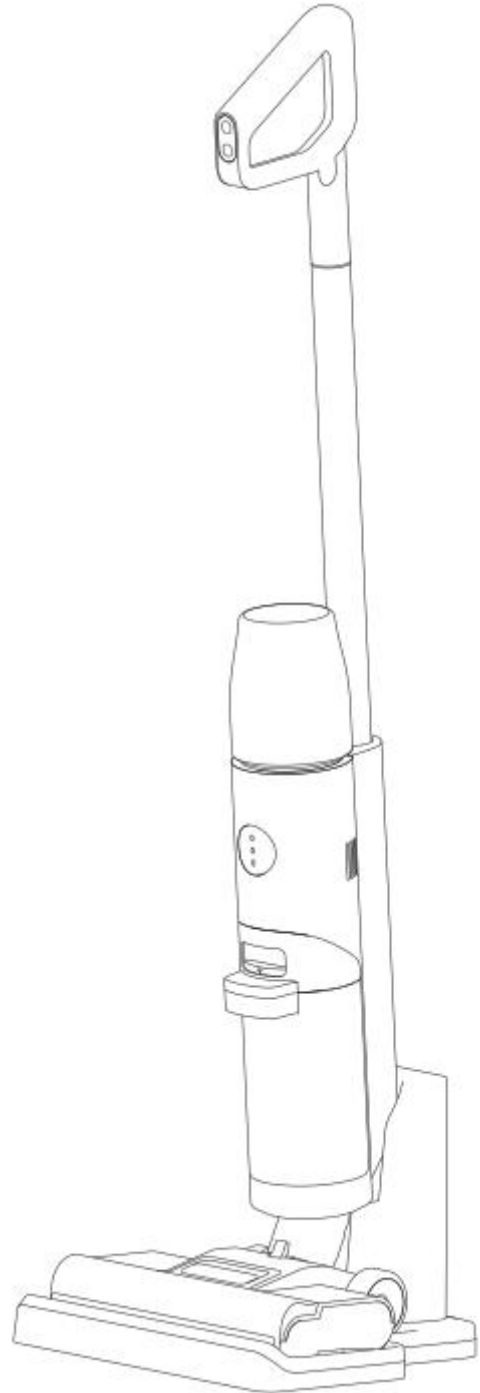

This picture is for reference only, and the actual product shall prevail.

Please read this manual carefully before use, and keep it properly for further reference.

## Table of Content

Safety Specifications-----	1
Product Introduction-----	3
Installation-----	7
Product Summary-----	8
Product Technology and Parameters-----	11
Maintenance and Service-----	12
Description of Hazardous Substances-----	15
After-Sales Service-----	16
Warranty Card-----	17

## Safety Specifications

In order to avoid accidental injuries such as electric shock and fire caused by improper operation, please read the User Manual carefully before use and keep this manual properly for further reference. This product is designed only for household use rather than outdoor use, non-ground use, commercial or industrial environments.

### **Warning**

Unless supervised or instructed by an adult guardian who can ensure that this product can be operated safely and properly, persons with physical, sensory, or intellectual disabilities or without experience and knowledge, including children, are prohibited from using this product.

- Children are prohibited from operating this product or using it as a toy. Close attention is required when children, pets, or plants are nearby or this product is operated near them; children are prohibited from cleaning or maintaining the product without supervision by their guardian.
- Plastic films used for product packaging may be dangerous, and they shall be kept away from children to avoid choking.
- This product is suitable for hard indoor floors; optimal results will not be achieved when used on uneven floors.
- As this product body and its floor brush have electrical components, they cannot be immersed in water or liquid. Do not operate this product unless all parts are installed.
- Do not touch the outlet, power adapter, or display with wet hands to avoid the risk of electric shock.
- Please remove the plug from the power socket and make sure that the product is in the power-off state when it is out of service or before cleaning, cleaning, maintaining, or repairing the product. When cleaning the roller brush, please turn off the main machine to prevent damage caused by the rotating roller brush. Do not operate this product if the roller brush, clean water tank, wastewater tank, or filter sponge is not installed in place.
- Do not use this product for flammable or highly volatile liquids and other chemically hazardous liquids (such as gasoline, kerosene, paints, and perfumes) or in areas where flammable or combustible liquids may be present. Otherwise, a short circuit or explosion of the product may occur.
- Do not use this product for toxic or harmful substances (chlorine bleach, ammonia, drain cleaner); or for sweeping hard or sharp objects (such as glass, nails, screws, and coins); or for removing unextinguished heat sources such as cigarette butts and matches to avoid fire.
- Do not use this product for removing powdered ink or toner in laser printers and copiers to avoid fire or explosion.
- Do not use this product for removing strong stains such as pigments, paints, and shoe polish.
- Do not use this product for foam-type cleaning liquids to avoid damage to the motor.
- Do not operate this product in an enclosed space filled with paint thinners emitting from the oily paint or with some anti-moth matter, combustible dust, or other explosive or toxic materials.
- Before use, ensure that any human hair, loose clothing, fingers, and body parts are kept away from the openings and moving parts of this product and its accessories.
- Do not block the air inlet and outlet to avoid machine overheating. Do not put any object at the suction port of the product. Do not operate this product when the suction port of the product is blocked. Please remove the dust, cotton wool, hair, or other items timely because they may cause the reduced airflow of the product.
- Please keep the ambient temperature in the range of 0-40°C when charging, storing, and operating this product.
- Please operate this product strictly according to the instructions in the manual.
- Please only use the type of liquid specified in the operating section of this manual, and its usage volume shall meet the regulations. Do not add other solutions (such as alcohol and disinfectant) without permission.
- Take extra care when cleaning on stairs to prevent falls.
- Please put this product on a level surface. Do not store this product in a place where icing may occur.
- When lifting or handling this product, ensure that this product is always in the OFF state. When handling this product, putting your finger on the switch or setting the switch in the ON state may cause an accident.
- Do not incinerate this product even if it has been severely damaged, because the battery may catch fire and explode. Please remove the battery before scrapping the product.
- Do not modify or try to repair this product except as described in the operation and maintenance instructions. Before cleaning or maintaining the product, please remove the power plug and ensure the power supply is in the OFF state. Repairs should be conducted by qualified maintenance personnel, and only the same replacement parts should be used.
- Do not continue to operate this product when it cannot work properly due to drops, damage, outdoor use, or water ingress. To avoid injury, do not try to run it but send it to the after-sales service center for repair.
- Before use, if any electric leakage of the product or excessively high temperature/ abnormal sound of the motor, such as body overheating, abnormal sound, and odor are identified, please stop the product immediately and contact the after-sales service for help.

## Safety Specifications

- Do not immerse the floor brush in water to avoid product burns. Do not shake or impact the machine violently to avoid wastewater flowing into the motor. When handling the product, please keep the product in an upright state to avoid wastewater flowing into the motor.

### **Battery and Charging**

- Do not charge this product outdoors. This product should only be used with the charging base and power adapter that come with the product. Otherwise, other types of charging bases may cause battery failure or extreme thermal effects.
- The charging base has an air drying function and is only suitable for roller brushes of floor scrubbers.
- Please follow all charging instructions and do not charge the product beyond the temperature range specified in the instructions. Improper charging or charging out of the specified temperature range may cause damage to the battery and increase the risk of fire.
- Be careful to prevent damage to the power cord. Do not drag or lift the product and charging block with the power cord, and do not use the power cord as a handle; do not insert the power cord in the door gap, and do not pull the power cord at sharp points and corners. Do not travel the product on the power cord, and keep the power cord away from heat sources.
- If the power cord of the power adapter is damaged, it must be replaced by the manufacturer, its service agent, or similarly qualified personnel to avoid danger.
- Do not hold the product or the plug of the charging base. To pull out the plug, please hold the plug of the charging base and do not pull the power cord.
- Do not short-circuit the output terminals of the battery pack or charging base.
- Do not charge, remove, heat (60°C and above) or incinerate discarded batteries.
- Do not expose this product to fire or excessive temperatures. Exposure to flames or temperatures above 130°C may cause an explosion.
- Do not use damaged or modified devices. Using damaged or modified batteries may cause unpredictable consequences, posing the risk of fire, explosion or injury.
- Liquid may eject from the battery with excessive force. Avoid contact with this liquid. In case of accidental contact, please rinse with water. If the liquid enters the eyes, please seek medical care immediately, as the liquid ejected from the battery may cause irritation or burns.
- This product must be disconnected from the power source before the battery is removed. Please put the battery in places out of reach of children; do not discard the battery without permission, and send it to the professional recycling agency for disposal. Do not put the battery in your mouth, and seek medical care as soon as possible if it is swallowed.
- The batteries in this product shall only be replaced by qualified technicians or after-sales personnel.
- If the product is out of service for a long time, turn off the power and remove the plug of the charging base.

## Product Introduction

### Packing list

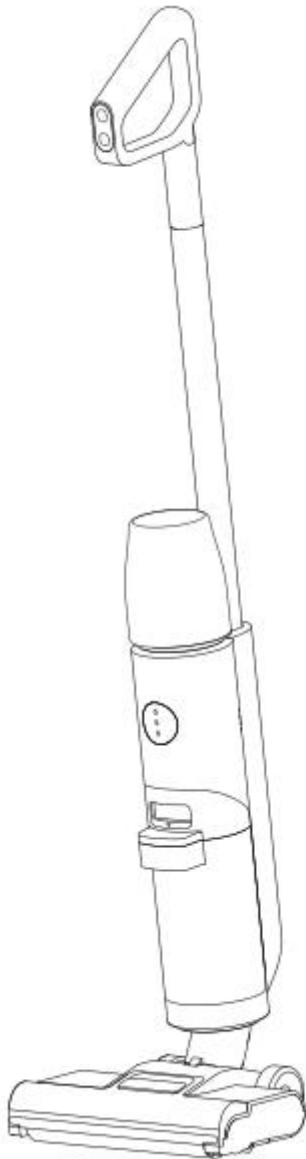

Main engine

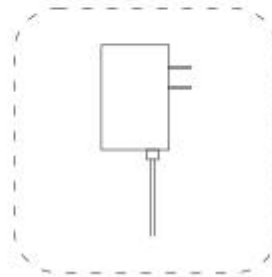

Adapter



Charging base

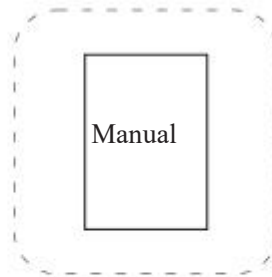

Manual

#### \*Notes:

The illustrations of the product, accessories and user interface in the manual are schematic and are for reference only.

The actual product will prevail as the products are improved continuously, and our company reserves the right to update the product.

# Product Introduction

## Product Description

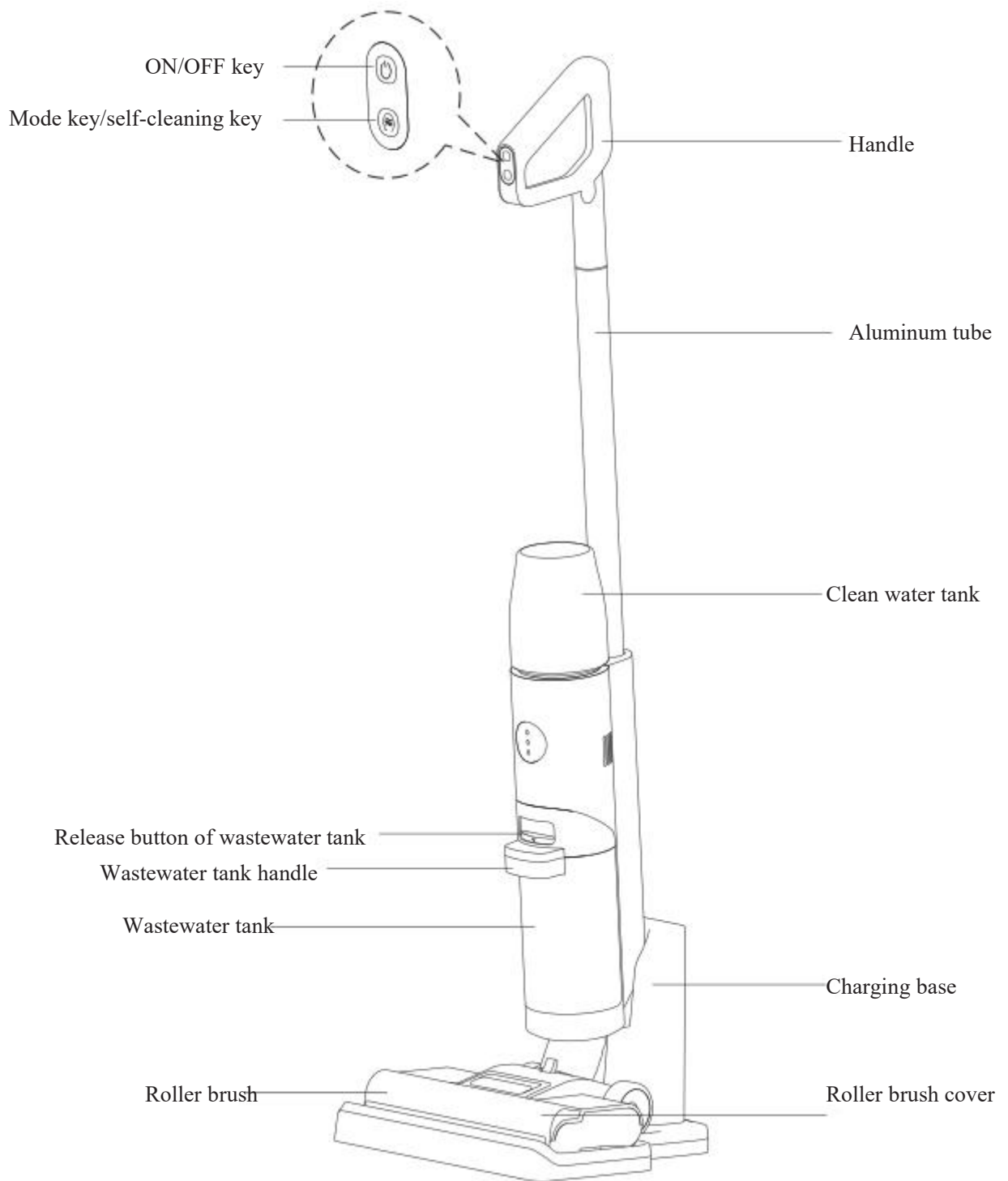

## Product Introduction

### Charging base Instruction

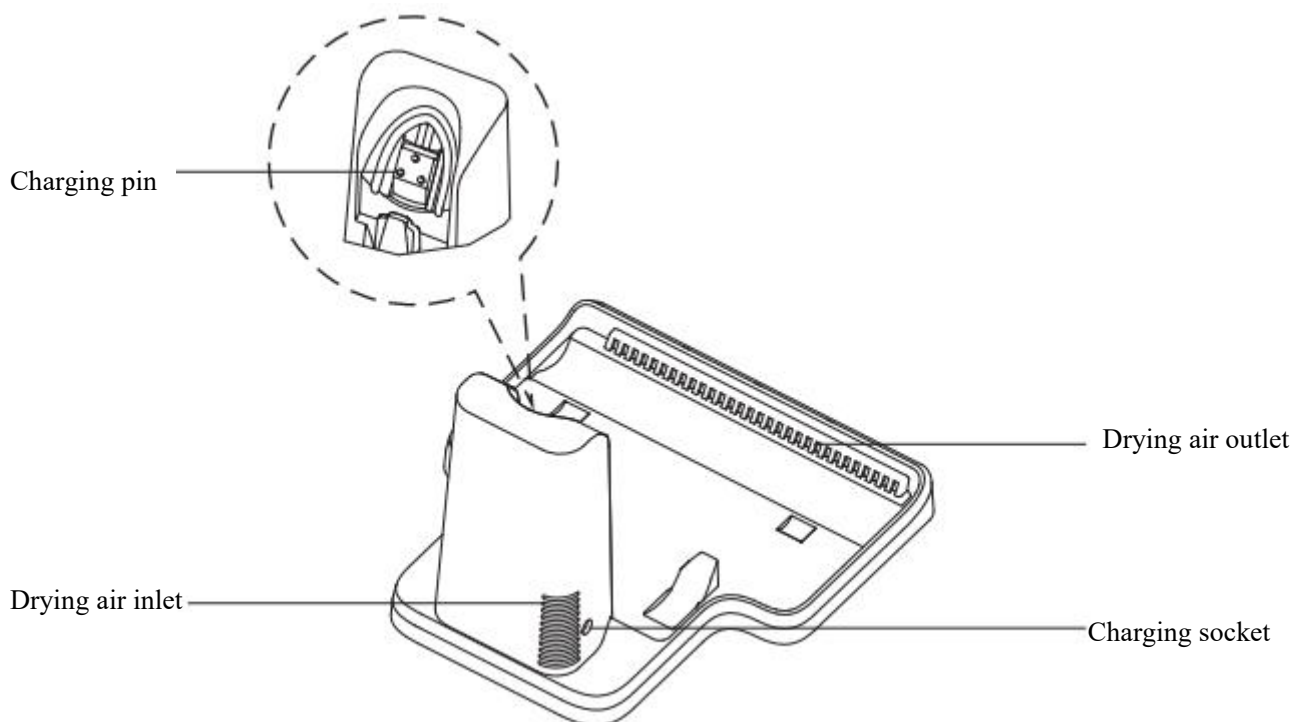

#### Self-cleaning + air drying function

Put the machine on the air drying base, and ensure that the machine is in the charging state; press the self-cleaning button to start the self-cleaning function; air will be blown out continuously from the air drying base to properly dry the robber brush after self-cleaning. Please timely clean the wastewater tank after cleaning, and remove any residual stains on the base if any.

⚠ Tips: ED10 has no air drying function, but ED11 has air drying function.

## Product Introduction

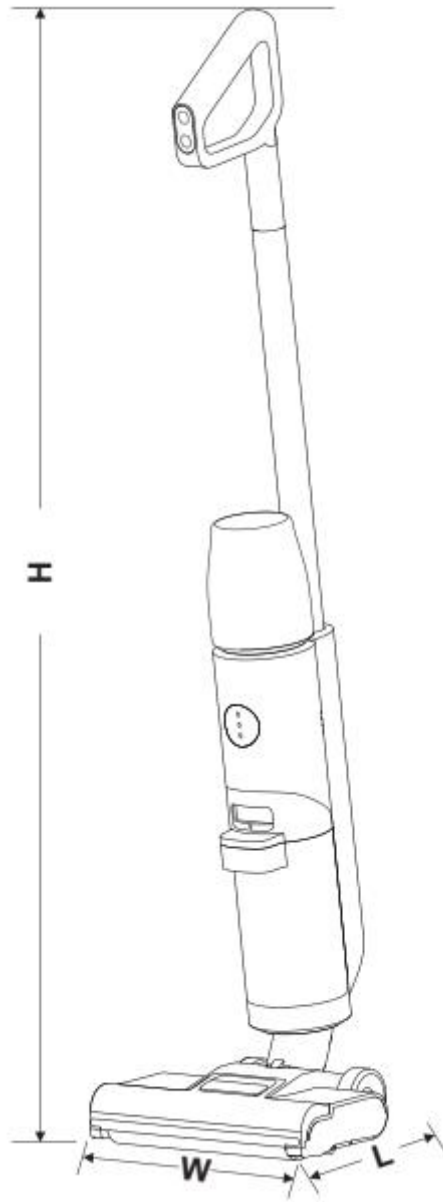

Size L: 28.2cm W: 27cm H: 112cm



# Installation

## Handle Disassembly

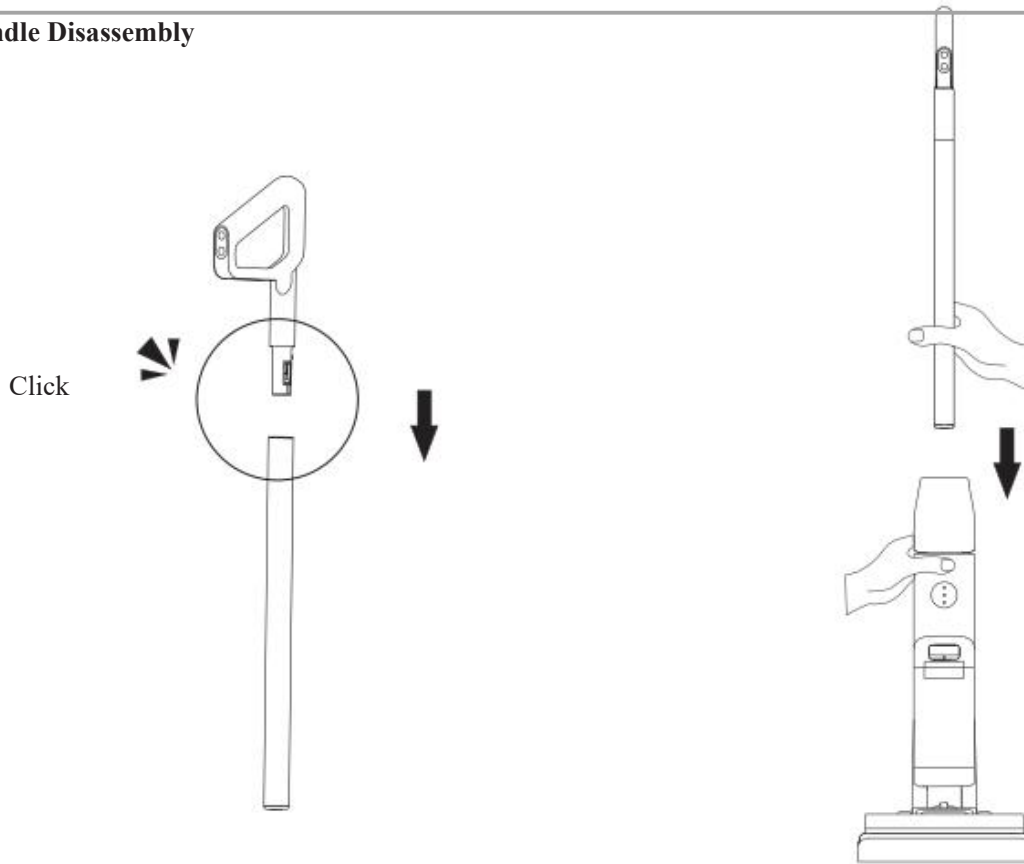

To remove the aluminum tube of the handle, insert a long, thin, and rigid object into the hole in the back of the body to press the elastic sheet while pulling the machine handle upwards.

Insert the end of the aluminum tube vertically into the hole on the host until a “click” sound is heard, and make sure that the tube is tightly inserted, indicating that it is installed successfully.

Insert the end of the handle vertically into the bore of the aluminum tube until a “click” sound is heard, and make sure that the handle is tightly inserted, indicating that it is installed successfully.

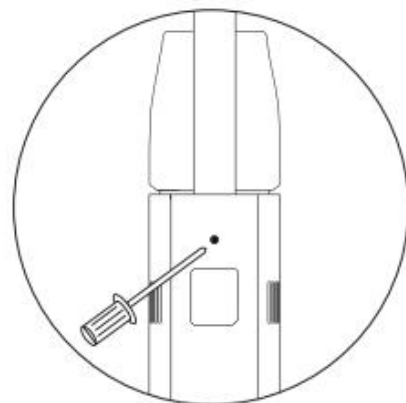

## Product Summary

### 1. Preparation before use

1) Before use, please check whether your floor scrubber battery has power; if not, please charge it timely. Do not use it until fully charged.

(Recommendation: please fully charge the product before first use).

Charging method:

Put the machine into the charging base, connect one end of the adapter to the charging base, and connect the other end to the socket in the home. When charging, put the machine upright in the charging base, and make it close to the corner of the wall to avoid injuries such as tripping. During the charging process, the light panel of the machine body displays the battery status. When fully charged, the light panel goes out. Put the power cord away when charging is not required.

#### ⚠ Tips

Please charge the product once every three months if it is out of service for a long time after purchase (Please be sure to use the charging base equipped with the product for charging; the charging time is about 4 hours, and fully charging is not required).

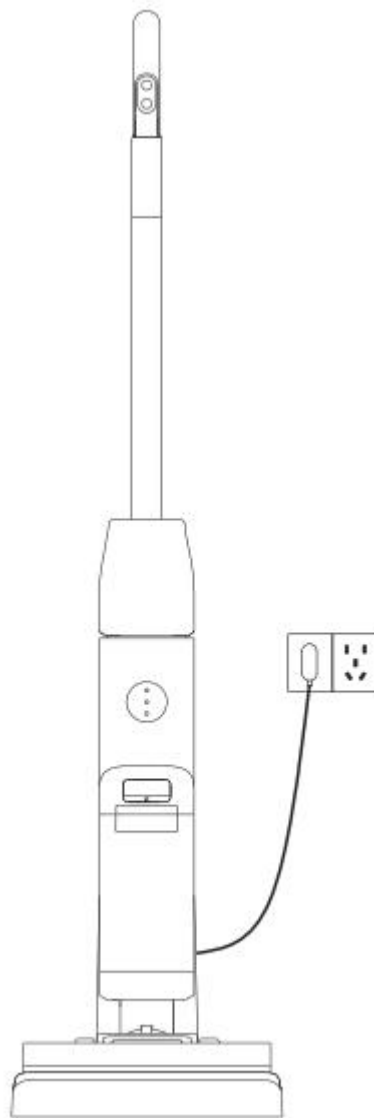

## Product Summary

### 2) Fill water in the clean water tank



Remove the clean water tank

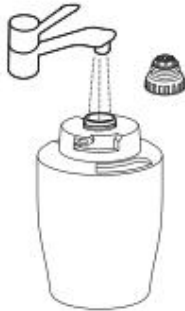

Open the silicone stopper and fill with water

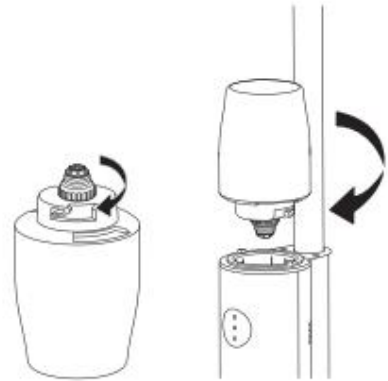

Install clean water tank on the body

## 2. Start to work

- 1) Startup: Press the Power button after the product is fully charged to start the machine, and press this button again to shut down the machine;
- 2) Mode switching: The AUTO (auto) mode is activated by default after startup. Press the Mode key to switch to the MAX (powerful) mode. The two modes alternate in turn;
- 3) Self-cleaning: When the machine is charging, press the self-cleaning button once to activate the self-cleaning function, and press this button again to deactivate the self-cleaning function; the machine enters the air drying mode after self-cleaning;

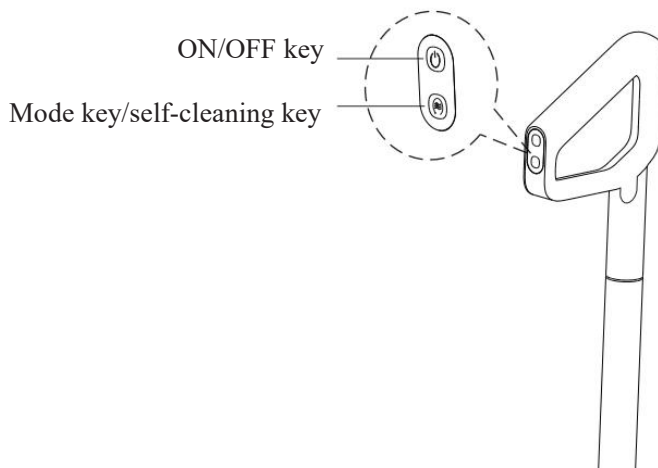

## 3. Cleaning after use

- 1) Self-cleaning of body pipes and roller brush
    - a. After use, please the machine into the charging base timely for charging, and press the self-cleaning button to clean the machine automatically.
    - b. The machine enters the air drying mode after self-cleaning, and then enter the charging state at the next stage;
- ⚠ Tips: Ensure enough water is kept in the clean water tank before self-cleaning.

## Product Summary

### 2) Clean the wastewater tank



Remove the wastewater tank

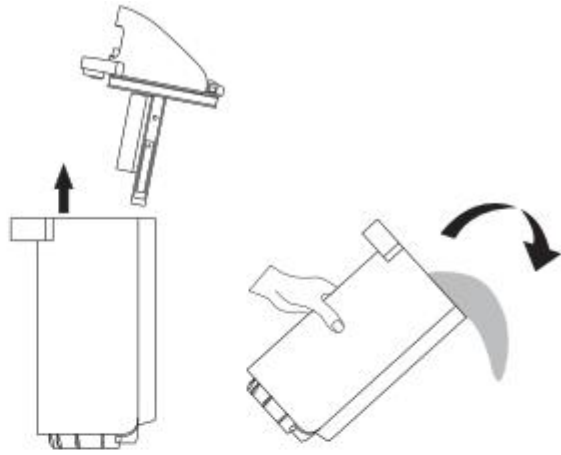

Open the wastewater tank

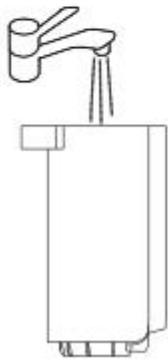

Clean the wastewater tank

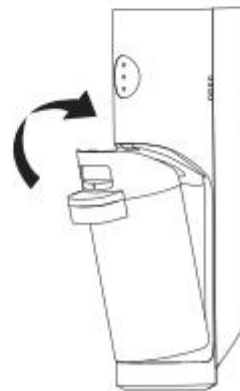

Install the wastewater tank

## Product Specifications and Parameters

Product name	Wireless intelligent floor washer
Product model (available)	ED10 / ED10W / ED10Z / ED10X / ED10M ED11 / ED11W / ED11Z / ED11X
Rated voltage	22.2V
Rated power	200W
Li-ion battery capacity	2600mAh
Clean water tank capacity	0.8L
Wastewater tank capacity	0.4L
Net weight	3.35kg
Product dimensions (mm)	1120*260*282
Rated input of the adapter	100-240V~ 50/60Hz 0.45A
Rated output of the adapter	27V $\equiv$ 0.5A

## Maintenance and Service

1. To prevent affecting the working performance of the machine, it is recommended to regularly clean and maintain the machine body, floor brush, dirt suction port, and wastewater tank;
2. Before cleaning, stop the machine and clean the machine body with a cloth dipping in water or neutral detergent; please wring out the cloth to avoid water stains penetrating the inside of the machine;
3. Wastewater tank cleaning: Please clean the wastewater tank timely every time after use, and clean the upper cover and filter of the wastewater tank regularly.

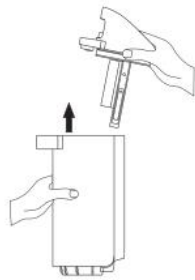

Remove the upper cover



Remove the filter, wash with clean water, and dry

4. Clean the water jet port on the roller brush cover and the roller brush.

- ▶ Users can clean the water spray port on the roller brush cover regularly according to the use conditions to avoid accumulation and scaling of stains to affect water flow.
- ▶ Remove the roller brush regularly for cleaning and drying to avoid long-term micro-wetness of roller brush resulting in odor.

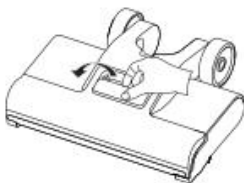

Remove the upper cover of lower roller brush in the arrow direction

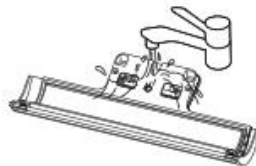

Wash the upper cover of roller brush



Disassemble the roller brush in the arrow direction

- ① Remove the end cover of roller brush in the arrow direction, and remove debris

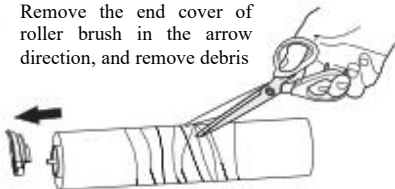

Wash it with clean water, and dry it



Install the roller brush in the arrow direction

- ②. Remove hairs from the surface of roller brush with scissors



Insert the latch of upper cover of roller brush into the hole in the arrow direction



Press the upper cover of roller brush in the arrow direction until a "click" sound is heard, so the installation is completed

## Maintenance and Service

### 5. Clean the suction nozzle of the floor brush

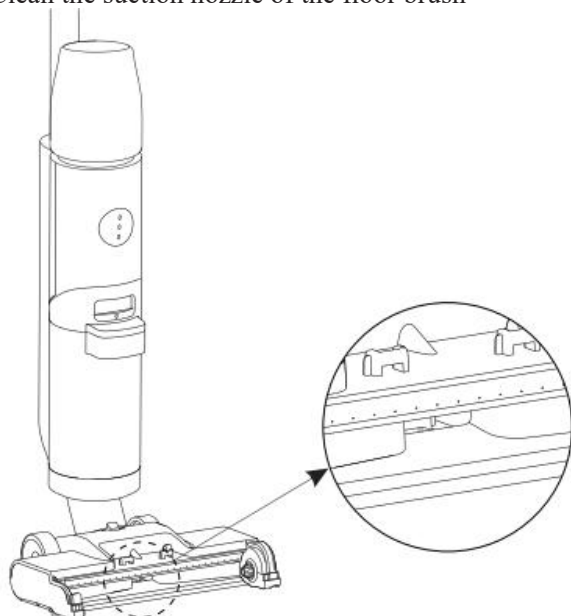

If the floor cannot be cleaned thoroughly after an extended period of use, please check whether the suction nozzle of the floor brush is blocked. When cleaning the roller brush, please remove dirt inside the suction nozzle with a clean brush or a wet cloth.

### 6. If any abnormality is identified during the product use, please refer to the table below.

Abnormal conditions	Possible causes	Solution
The floor scrubber does not work, or an alarm is issued	<ul style="list-style-type: none"> <li>-The roller brush is wrapped in objects such as hair</li> <li>-The wastewater tank is full</li> <li>-Low battery</li> </ul>	<ul style="list-style-type: none"> <li>-Clean the rollers after shutting down</li> <li>-Pour wastewater out of the wastewater tank</li> <li>-Charge</li> </ul>
Impaired suction power of the product	<ul style="list-style-type: none"> <li>-Roller brush, roller brush cover, and wastewater tank are not installed in place</li> <li>-The roller brush is wrapped in objects such as hair</li> <li>-The suction nozzle or pipe is blocked</li> <li>-The filter above the inside of the wastewater tank is dirty</li> <li>-The filter of the wastewater tank is dirty or missing</li> </ul>	<ul style="list-style-type: none"> <li>-Reinstall</li> <li>-Clean the roller brush</li> <li>-Remove the obstacles from the suction nozzle or the inside of the pipe</li> <li>-Clean the filter before use</li> <li>-Clean or install the filter before use</li> </ul>
Abnormal sound is heard when the fan is running	<ul style="list-style-type: none"> <li>-The suction nozzle is blocked</li> <li>-The liquid level in the wastewater tank has reached the specified level</li> </ul>	<ul style="list-style-type: none"> <li>-Remove the obstacles from the suction nozzle</li> <li>-Take out the wastewater tank, pour the wastewater, and install the tank again</li> </ul>
No water is jetted from the floor brush	<ul style="list-style-type: none"> <li>-There is no water in the clean water tank</li> <li>-The clean water tank is not installed in place</li> </ul>	<ul style="list-style-type: none"> <li>-Fill water in the clean water tank</li> <li>-Reinstall the clean water tank</li> </ul>
Water leakage at the air outlet	<ul style="list-style-type: none"> <li>-The wastewater tank filter is not dried after cleaning and use</li> </ul>	<ul style="list-style-type: none"> <li>-Wash, and dry before use</li> </ul>
Water leakage from the bottom of the floor brush	<ul style="list-style-type: none"> <li>-No wastewater tank or wastewater tank filter is installed</li> </ul>	<ul style="list-style-type: none"> <li>-Install the wastewater tank and filters</li> </ul>

In case of failure to solve any fault, please contact the local after-sales service outlet or call the national service hotline: +86 512 6786 2180

## Maintenance and Service

### 7. Description of abnormal conditions of lights

Abnormal conditions	Light warning	Solution
Short circuit	The red light flashes 5 times	Contact the customer service center and sent it to the factory for repair
The wastewater tank is full	The red light flashes 4 times	Pour wastewater water
The charging temperature is abnormal	The red light flashes 3 times	Charge after being placed quietly at room temperature
The adapter voltage is abnormal	The red light flashes 3 times	Use the original charger or sent it to the factory for repair
The battery is dead	The red light flashes 3 times	Contact the customer service center and sent it to the factory for repair
The motor current is abnormal	The red light flashes 5 times	Power off the machine and dry
The floor brush is blocked	The red light flashes 5 times	Remove impurities from the roller brush
The battery is overheating	The red light flashes 8 times	Power off the machine and leave it idle for 30 minutes
The battery is damaged	The red light flashes 12 times	Contact the customer service center and sent it to the factory for repair
The battery is exhausted	The red light flashes 5 times	Charging base



## Description of Hazardous Substances

1. This product meets the requirements of the Management Measures for the Restriction of the Use of Hazardous Substances in Electrical and Electronic Products.
2. During the environmental protection use period, no harmful substances that affect their health are leaking or precipitating, and consumers can operate it safely.
3. The environmental protection use period of the company's products is 10 years. The "environmental protection use period" is valid only when this product works under normal conditions as described in this manual.



Part name	Hazardous substances					
	Pb	Hg	Cd	Cr(VI)	PBB	PBDE
Main body	O	O	O	O	O	O
Clean water tank assembly	O	O	O	O	O	O
Wastewater tank assembly	O	O	O	O	O	O
Floor brush assembly	O	O	O	O	O	O
Battery	X	O	O	O	O	O
Electronic circuits	X	O	O	O	O	O
Adapter	X	O	O	O	O	O
Motor assembly	O	O	O	O	O	O
Other accessories	O	O	O	O	O	O

This table is prepared in accordance with the provisions of SJ/T11364

O: Meaning that the content of the hazardous substance in all homogeneous materials of the component is below the limit specified in GB/T26572.

X: Meaning that the content of the hazardous substance in at least one homogeneous material of the component exceeds the limit specified in GB/T26572. (Note: Some of the parts marked "X" above contain hazardous substances that exceed the limit due to the current technical level of the industry, and substitutes or reductions cannot be realized temporarily.)

## After-Sales Service

The free warranty period of the entire machine is one year, and the warranty will be invalid for any of the following situations:

1. Corresponding consumables and gifts;
2. Damaged due to improper handling, operation, maintenance, and storage by the user;
3. Damaged due to the charging voltage lower than 100V or higher than 240V;
4. Damaged by failure to follow the user manual for operation, maintenance, and service;
5. Disassembled and repaired by non-professional service personnel not designated by the company;
6. The warranty period of the product expires;
7. The model or number recorded on the invoice or warranty card is inconsistent with the actual product;
8. Damaged due to force majeure;

### Tips:

1. Please keep your purchase invoice and related receipts as an essential basis for warranty service.
2. This product is only a household one, and the company is not responsible for any problem caused by its use outside the household.

## Warranty Card

Relevant information (filled in by the user)			
User name		Frequently used phone	
Contact address			
Product model		Product No.	
Purchase store		Date of purchase	
Repair station		Invoice number	

Repair Records			
Date of repair			
Fault content			
Troubleshooting details			
Name of the repair unit		Phone of repair unit	
Signature of the repairman			

Customer service hotline +86 512 6786 2180.

Please keep the warranty card properly and provide the original warranty card and valid invoice for the repair.

Product Certificate  
Product Model: \_\_\_\_\_  
Inspector No.: \_\_\_\_\_  
Date of check: \_\_\_\_\_  
Check conclusion: \_\_\_\_\_



# JONR

Suzhou New Ebao Technology Co., Ltd.

Address: 2-201 (1), building 1, Microsystem Park, No. 2, Peiyuan Road, High-Tech Zone, Suzhou

Contact number: +86 512 6786 2180

Website: <http://jonr.cc>