



# SPACE M

● SINGLE

●● DOUBLE



ISOLATION



LOW, MEDIUM  
& HIGH TONES

A comfortable solution when you need to focus on your work or run a short one-to-one meeting.

**MUTE.**

**SHAPE AND DIMENSIONS mm**

+/- 3 mm

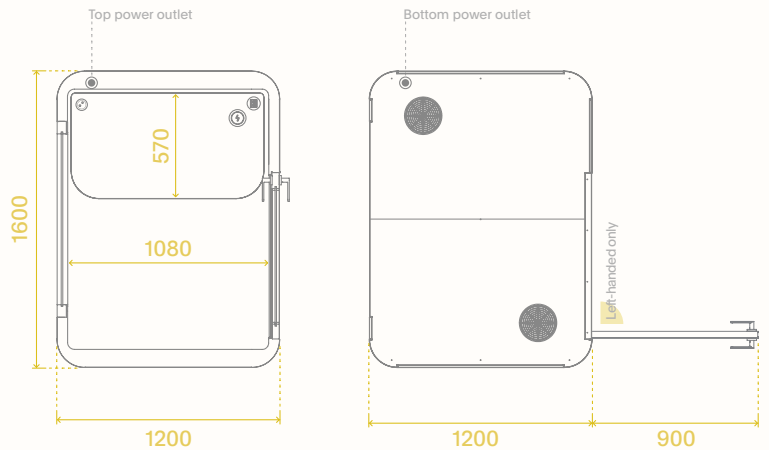
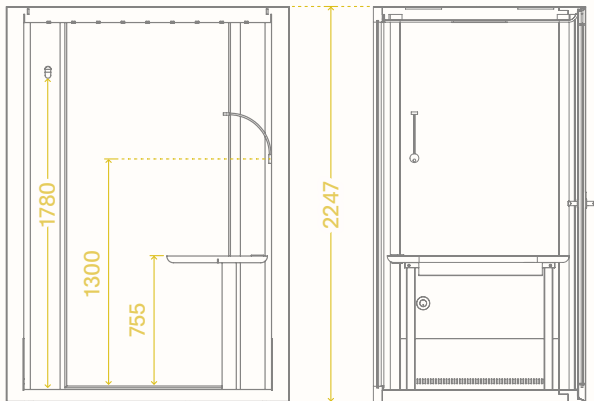

**DIMENSIONS mm**

	WIDTH	DEPTH	HEIGHT
External	1600	1200 +900 mm with open door	2247 +20 mm for leveling
Internal	1360	1080	2080

**WEIGHTS kg**

NET	GROSS
450	500 including wooden case and packaging parts

**COMPOSITION**

The construction of Space M is the effect of work of our acoustics, technology and design departments. Walls of Space M are built from several layers of meticulously chosen materials responsible for one of the highest results of sound isolation and sound absorption inside the pod.

- Absorbing materials
- Felt
- Isolating materials
- Metal covers
- Plywood
- Secure glass

**USAGE**

- Open space
- Call center
- Library
- Reception
- Breakout area
- Other public spaces (including railway stations and airports)

**CARE**

- Keep the product dry
- Vacuum and clean regularly
- Follow the assembly instructions and terms of use

**AVERAGE SOUND INSULATION**

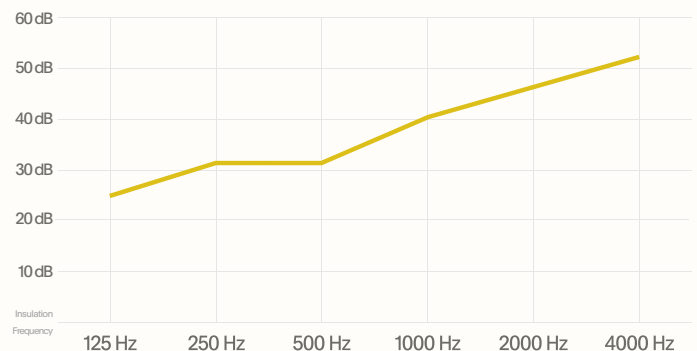

**RT20 PERFORMANCE INSIDE PER PN-EN ISO 354:2005**

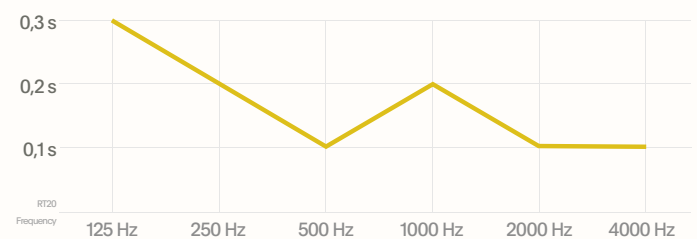

**PACKING**

- Space M is delivered in a wooden case:

W 2360 × D 1085 × H 1510 mm

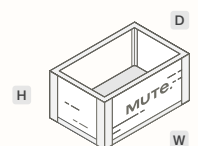

TECHNICAL SPECIFICATIONS

POWER CONSUMPTION



Standby: 4,5 W  
Working: 16 W (fans, LEDs)  
CE ✓RoHS 3 m cable



Max. power supply (exc. plugged receivers): 55 W  
Power supply voltage: 100 - 240 V AC (50/60Hz)  
Supply voltage for ventilation, lighting and addons: 12 - 24 V DC

FANS PERFORMANCE



Airflow: 73 m<sup>3</sup>/ hour



Fan emitted noise level in L<sub>Aeq</sub>  
Inside ≤ 38 db  
Outside ≤ 37 db



The level of outside noise measured at a distance of 1.5 meters. The Space series achieves one of the best results on the market.

External fan noise is comparable to one in typical open offices (<45 dB) and will create an acoustic background for employees nearby.

LIGHTNING



Power: 7 W  
Brightness for sitting position: 300 lx (1230 lm at source)  
Brightness for standing position: 450 lx (1230 lm at source)  
Light color temp.: 4000K



Fans and light activated by occupancy sensor



Wall lamp with 17 W USB-charger  
Brightness: 100 lx  
Light color temp.: 4000K  
Power usage: 1,5 W

GLASS PROPERTIES PER EN 410



Light transmission: 87  
Light reflection: 8  
Solar energy transmittance: 70  
Reflection of solar radiation: 7  
Total solar energy transmittance: 76

HEALTH AND SUSTAINABILITY COMPLIANCES



Formaldehyde and VOC safe: EU E1 Standard  
Quality management system of ISO 9001  
Environmental management system of ISO 14001

STANDARD EQUIPMENT



Ventilation system



LED Light



Occupancy sensor



Electric socket<sup>1</sup>



Graphite carpet



Wall hook max load 5 kg



Desk without height adjustment

OPTIONAL ADDONS



Dual USB-A port<sup>2</sup> integrated in a tabletop



Induction charger<sup>2</sup> integrated in a tabletop



LAN connection<sup>3</sup> with 10 m wire



Desk height adjustment in Linak system



Flexible lamp<sup>2</sup> with USB-A port



CBS Lima monitor arm (white/black/silver)



Light and ventilation control panel



Integrated wheels for easy relocation

DESK PROPERTIES



Standard desk without height adjustment

30 kg Total weight (top and frame)  
760 mm Mounting height



Optional Linak system of height adjustment

1250  
↕ Adjustment range in mm  
630

<sup>1</sup> Socket type E is installed as standard. Other electrical type should be requested.  
<sup>2</sup> Electric socket, USB ports, lamp and induction charger are available only in black.  
<sup>3</sup> An optional 10 m LAN cable is set with a main power wire.

**SHAPE AND DIMENSIONS** mm

+/- 3mm

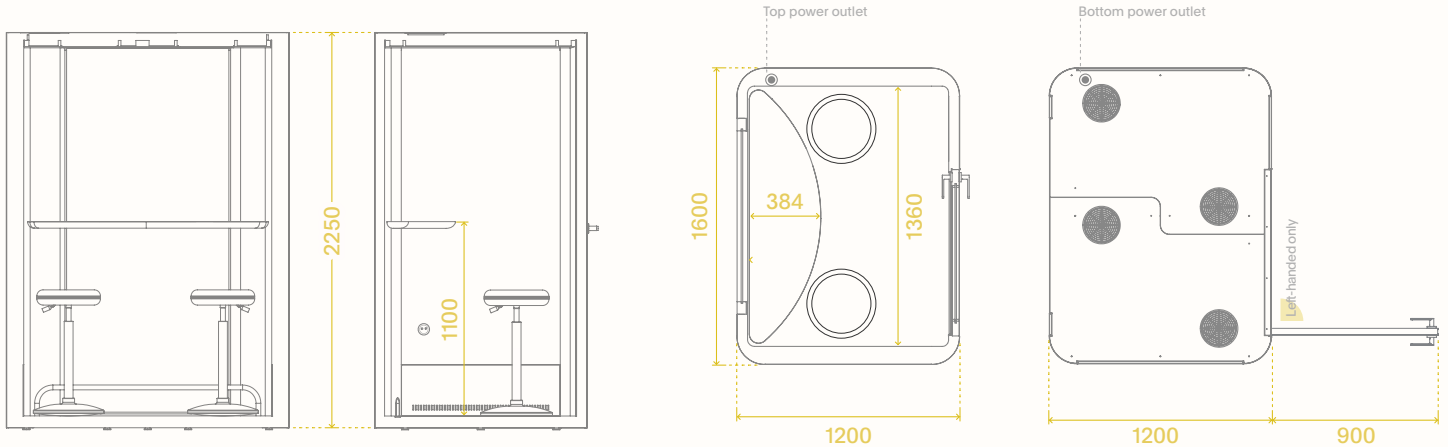

**DIMENSIONS** mm

	WIDTH	DEPTH	HEIGHT
External	1600	1200 +900 mm with open door	2250 +20 mm for leveling
Internal	1360	1080	2080

**WEIGHTS** kg

NET	GROSS
430	480 including wooden case and packaging parts

**COMPOSITION**

The construction of Space M is the effect of work of our acoustics, technology and design departments. Walls of Space M are built from several layers of meticulously chosen materials responsible for one of the highest results of sound isolation and sound absorption inside the pod.

- Absorbing materials
- Felt
- Isolating materials
- Metal covers
- Plywood
- Secure glass

**USAGE**

- Open space
- Call center
- Library
- Reception
- Breakout area
- Other public spaces (including railway stations and airports)

**CARE**

- Keep the product dry
- Vacuum and clean regularly
- Follow the assembly instructions and terms of use

**AVERAGE SOUND INSULATION**

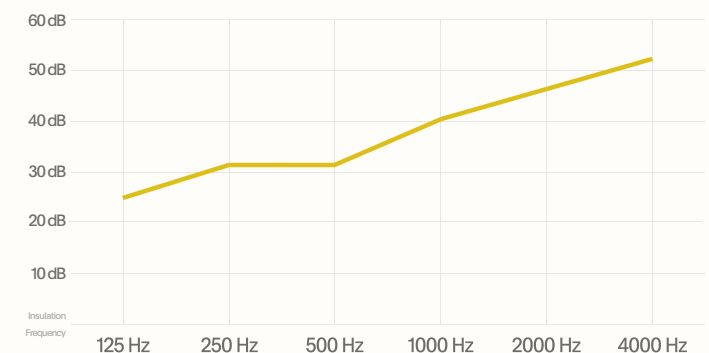

**RT20 PERFORMANCE INSIDE PER PN-EN ISO 354:2005**

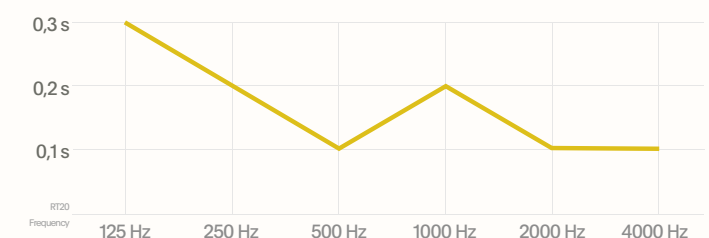

**PACKING**

- Space M is delivered in a wooden case:

W 2360 × D 1085 × H 1510 mm

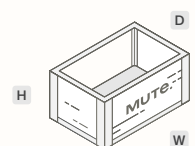

TECHNICAL SPECIFICATIONS

POWER CONSUMPTION



Standby: 4,5 W  
Working: 35 W (fans, LEDs)  
CE ✓RoHS 3 m cable



Max. power supply (exc. plugged receivers): 40 W  
Power supply voltage: 100 - 240 V AC (50/60Hz)  
Supply voltage for ventilation, lighting and addons: 12 - 24 V DC

FANS PERFORMANCE



Airflow: 108 m<sup>3</sup>/ hour



Fan emitted noise level in L<sub>Aeq</sub>  
Inside ≤ 39 db  
Outside ≤ 37 db



The level of outside noise measured at a distance of 1.5 meters. The Space series achieves one of the best results on the market.

External fan noise is comparable to one in typical open offices (<45 dB) and will create an acoustic background for employees nearby.

STANDARD EQUIPMENT



Ventilation system



LED Light



Occupancy sensor



Electric socket<sup>1</sup>



Graphite carpet



2 wall hooks max load 5 kg



Wall-mounted tabletop

OPTIONAL ADDONS



Dual USB-A port<sup>2</sup> integrated in a tabletop



Induction charger<sup>2</sup> integrated in a tabletop



LAN connection<sup>3</sup> with 10 m wire



High adjustable stool with footrest (1 or 2)



Light and ventilation control panel



Integrated wheels for easy relocation

LIGHTNING



Power: 14 W  
Brightness: 520 lx (1230 lm at source)  
Light color temp.: 4000K



Fans and light activated by occupancy sensor



Wall lamp with 17 W USB-charger  
Brightness: 100 lx  
Light color temp.: 4000K  
Power usage: 1,5 W

GLASS PROPERTIES PER EN 410



Light transmission: 87  
Light reflection: 8  
Solar energy transmittance: 70  
Reflection of solar radiation: 7  
Total solar energy transmittance: 76

HEALTH AND SUSTAINABILITY COMPLIANCES



Formaldehyde and VOC safe: EU E1 Standard  
Quality management system of ISO 9001  
Environmental management system of ISO 14001

DESK PROPERTIES AND OPTIONAL STOOL'S DIMENSIONS mm



Standard tabletop without height adjustment

11 kg Total weight

1100 mm Mounting height



High adjustable stool with footrest in Remix3

8 kg Total weight

✓ Moveable

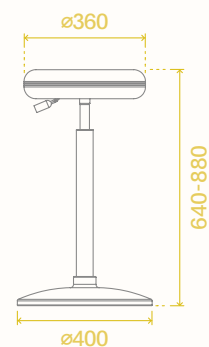

<sup>1</sup> Socket type E is installed as standard. Other electrical type should be requested.

<sup>2</sup> Electric socket, USB ports and induction charger are available only in black.

<sup>3</sup> An optional 10 m LAN cable is set with a main power wire.

FINISHES

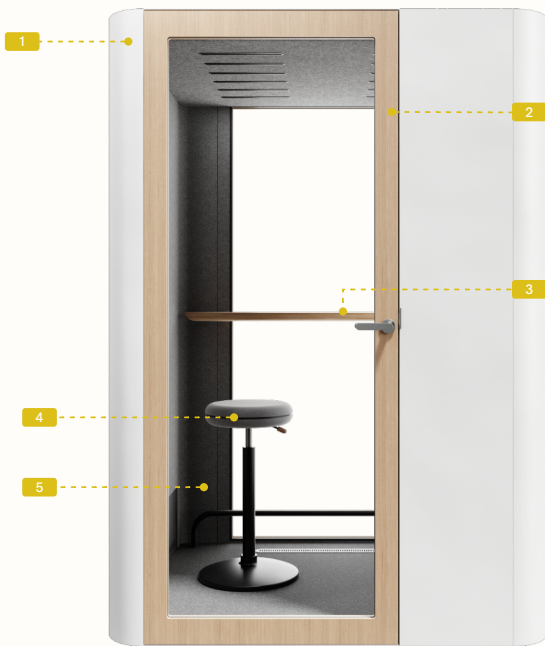

1 EXTERNAL WALLS AND ROOF PAINT COLOURS

STANDARD		Snow White Ultra Matt RAL 9003	
		Powder Grey Ultra Matt RAL 7035	
EXTRA		Pepper Grey Ultra Matt RAL 7012	
		Ceramic Red Ultra Matt NCS S 4050-Y70R	
		St. Tropez Yellow Ultra Matt RAL 1018	
		Whiteboard White Glossy Anti-graffiti coating	

2 EXTERNAL FRAME LAMINATES & VENEERS

STANDARD		Snow White NCS S 05000-N	
		New York Grey NCS S 3000-N	
EXTRA		Dusk Blue NCS S 4010-B50G	
		Whiteboard White Glossy 9317-HW	
		Oak Wood	

3 INTERNAL TABLETOP LAMINATES & VENEERS

STANDARD		Snow White NCS S 05000-N	
		Powder Grey NCS 1502-G	
EXTRA		Dusk Blue NCS S 4010-B50G	
		Grey Premium Anti-fingerprint 0725	
		Maple Wood	

4 INTERNAL OPTIONAL STOOL FABRIC FOR  DOUBLE

KVAADRAT REMIK 3		0422		0452		0566		0906
		0242		0123		0136		0133
		0152		0173				

5 INTERNAL FELT LININGS

	Beige		Grey
	Dark Grey		



Space M | **MUTE.**