

Climbing Playset

» Jungle GYM

WALL-MOUNTED & FOLDABLE

For Space Constraint Homes...



Assembly Instruction Manual

Expandable
From
1 ft. to 10 ft.
in no time

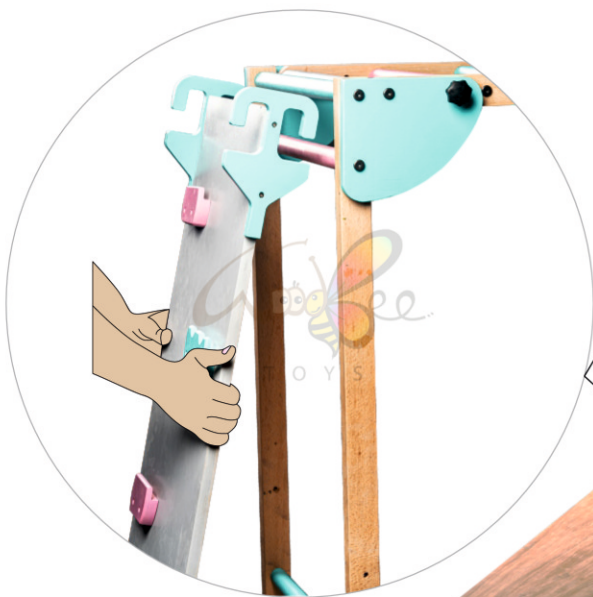

Reversible
Slider cum
Mountain Climber

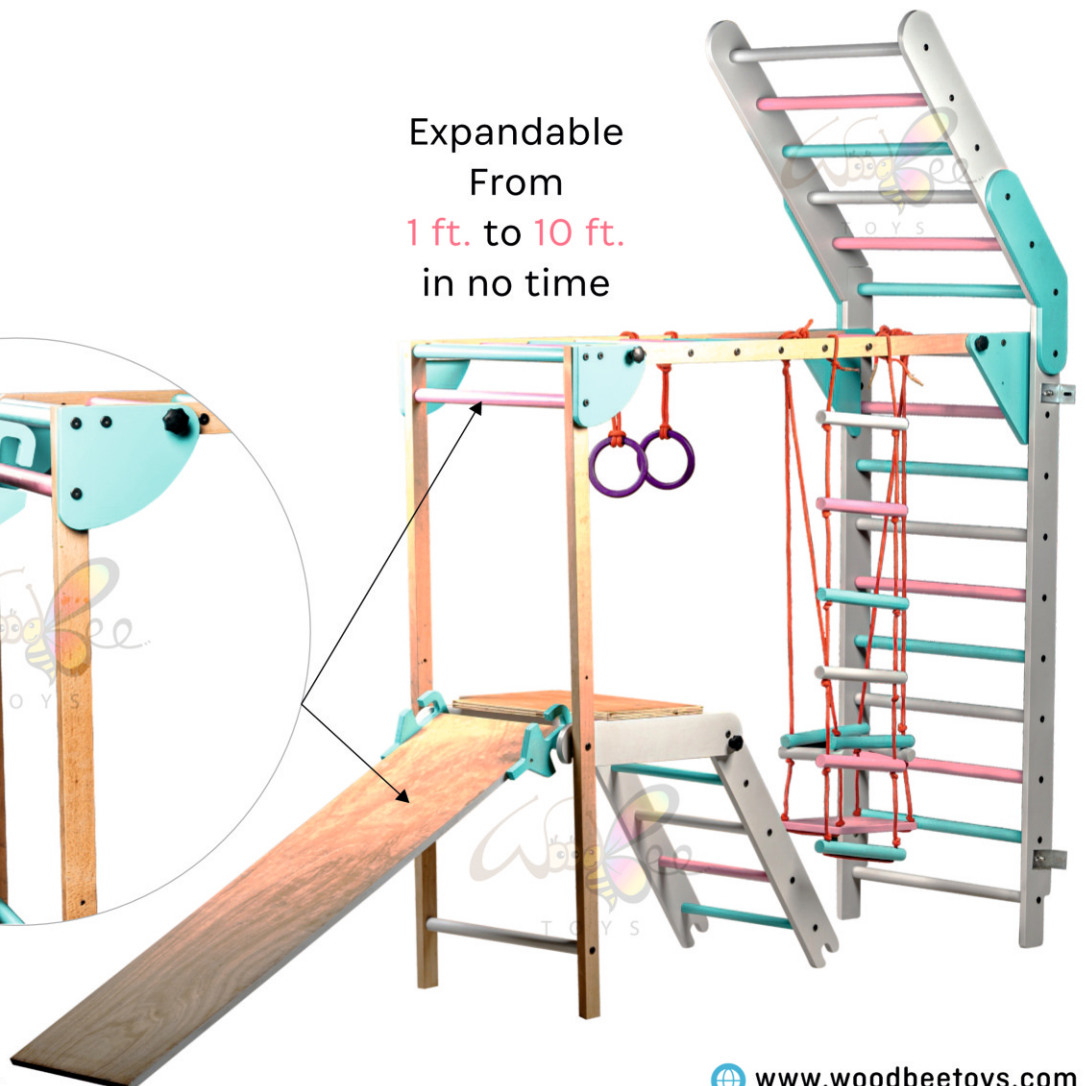

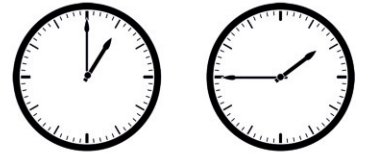

Assembly time : Approx 45 mins.

List of Items



(a)
Allen key
1 No.



(b)
Allen Screw
(Large)
10 Nos.



(c)
Allen Screw
(Small)
30 Nos.



(d)
Knob
Screw
6 Nos.

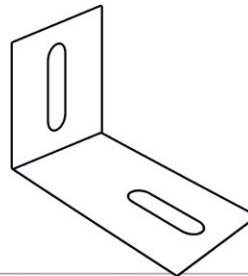

(e)
Wall Mounting
Clamp
4 Nos.

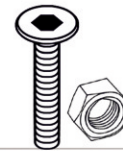

(f)
Clamp
Allen Screw
4 Nos.

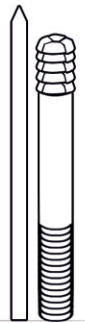

(g)
Pin Type
Hanger
Bolt
4 Nos.

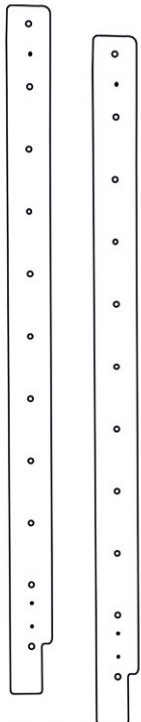

A1-A2
2 Nos.

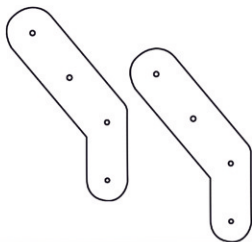

B1-B2
2 Nos.

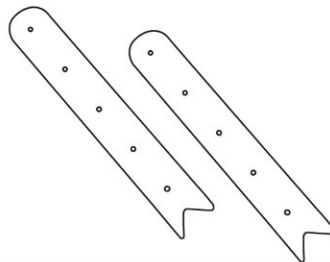

C1-C2
2 Nos.

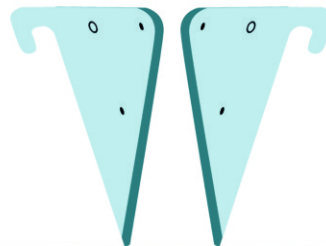

D1-D2
2 Nos.

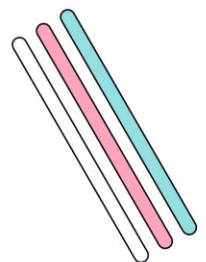

Beech
Wood Rods
16 Nos.

Also Including :-

- Monkey bar structure
- Reversible slider cum mountain climber
- Small ladder with platform structure
- Rope ladder
- Swing
- Gymnastic ring.

Note : Please ensure availability of all materials listed before starting assembly.

Step 1

Fix the beech wood rods to the frames A1-A2 and C1-C2 with allen screw (small) (c) using allen key (a)

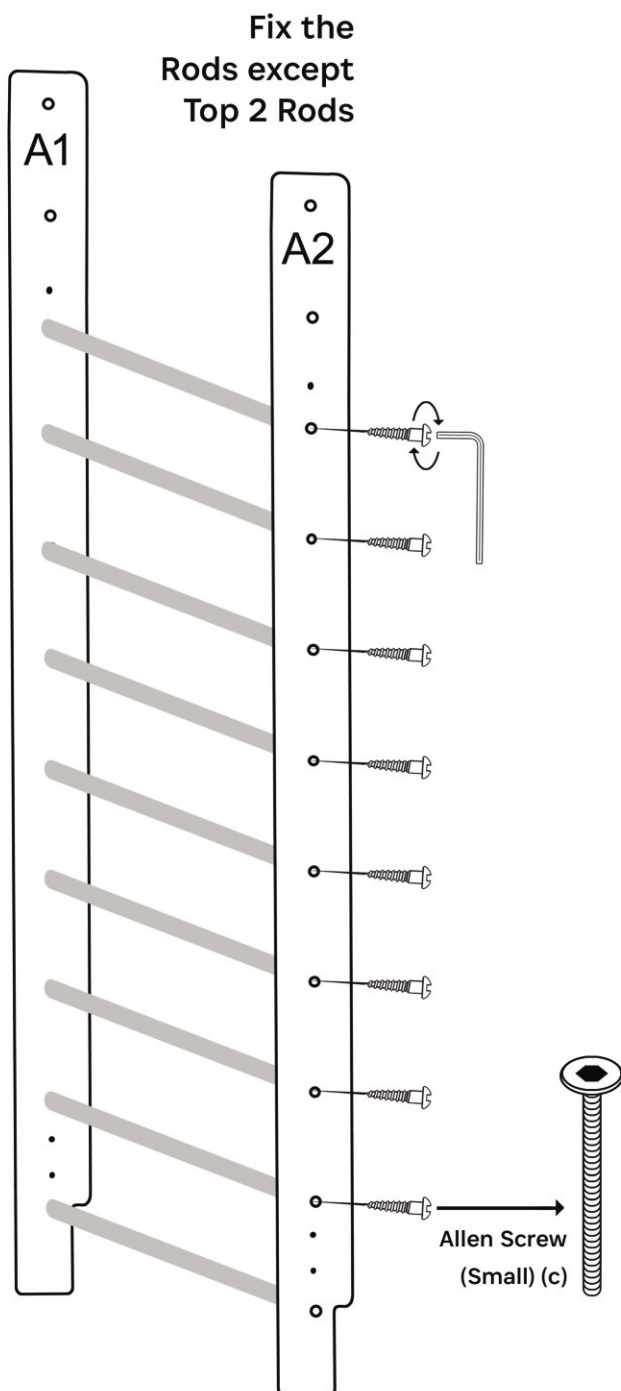

Fix the Top 3 Rods First

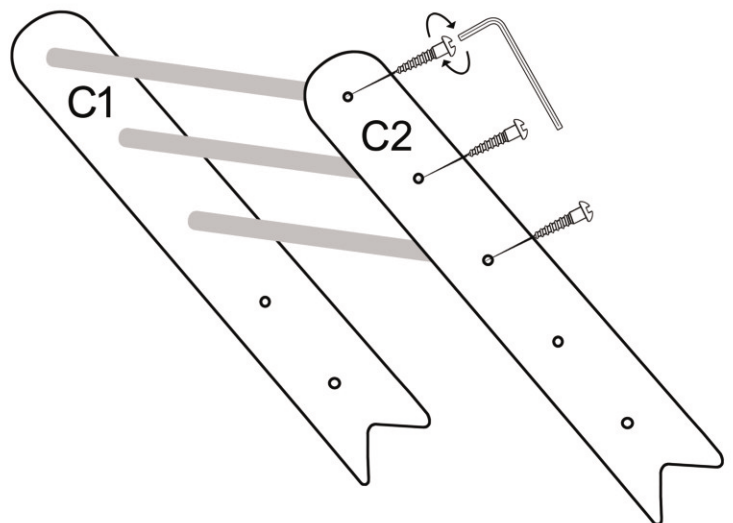

Step 2

Use the wall mounting clamps provided to fix A1-A2 structure to the wall. Use the given clamp allen screw (f) and pin type hanger bolt (g) on to the frame and wall respectively.

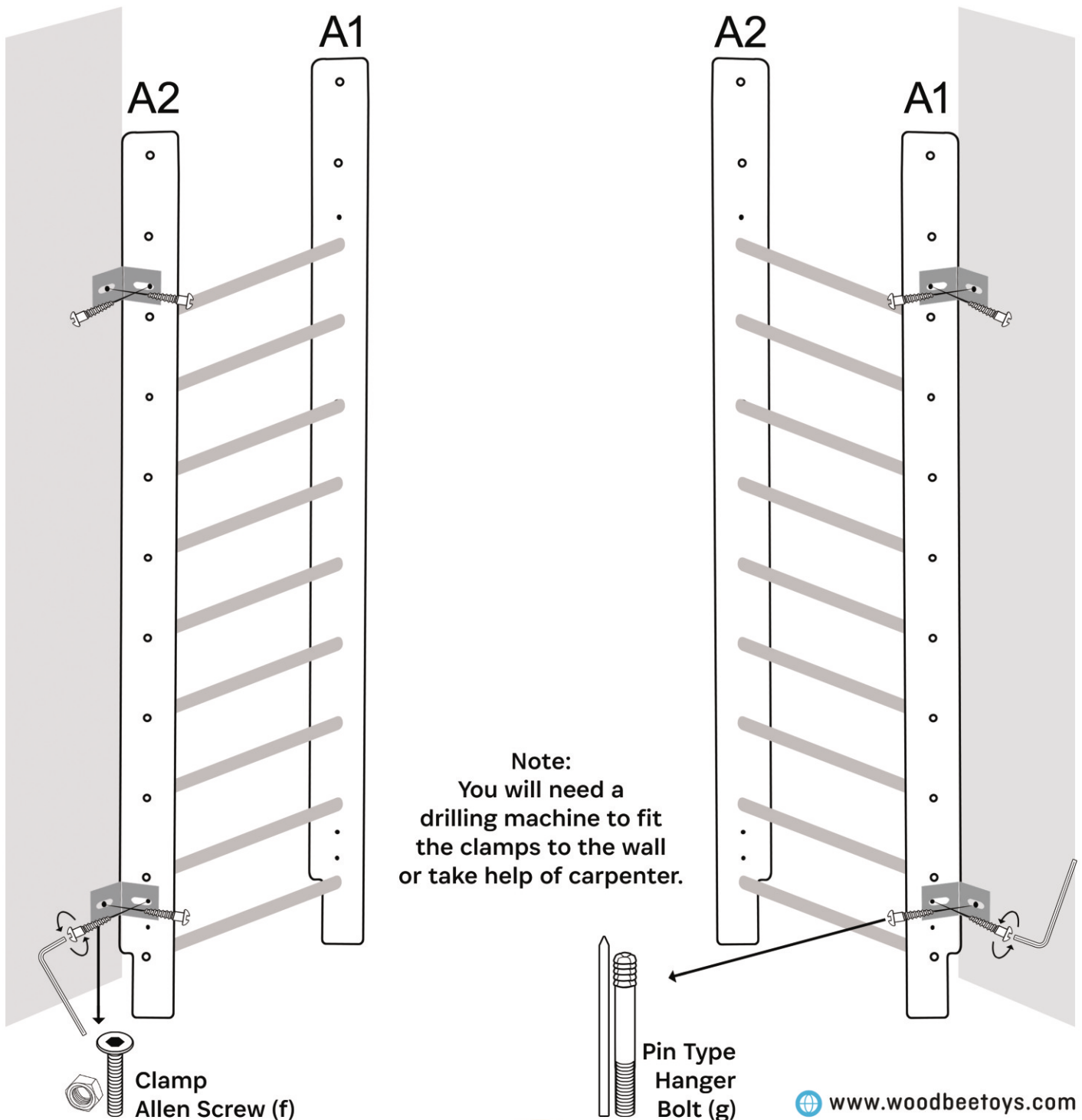

Step 3

Place the structure C1-C2 (assembled in step: 1) on top of A1-A2. Use screw (large) (b) to fix B1 with A1 -C1 frame and beech wood rods.

Similarly use allen screw (large) (b) to fix B2 with A2-C2 frame and beech wood rods.

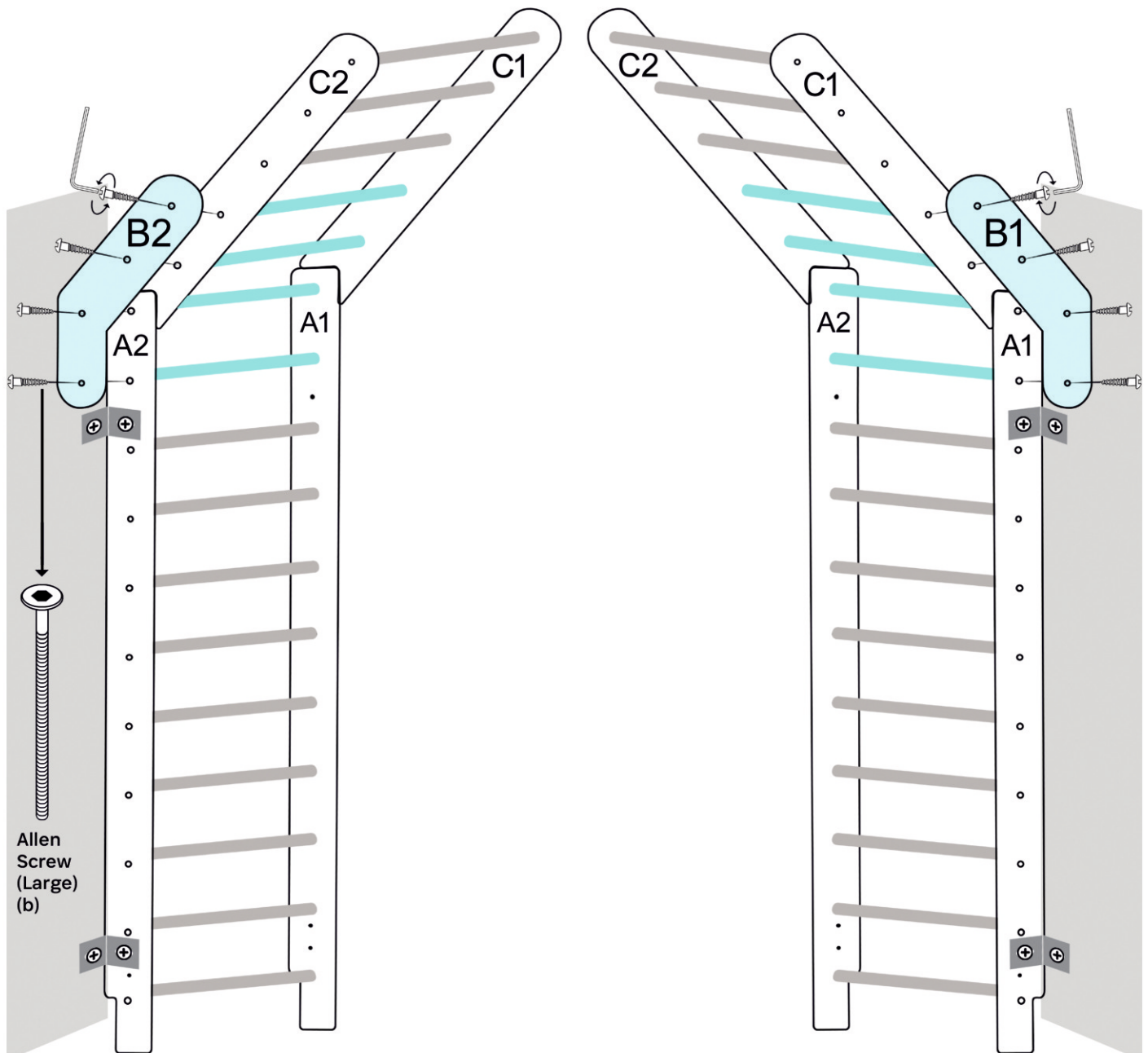

Step 4

Take this monkey bar structure and open it as shown. Use knob screw (d) to fix frame E and F at 90° at the hole provided in frame G on both sides.

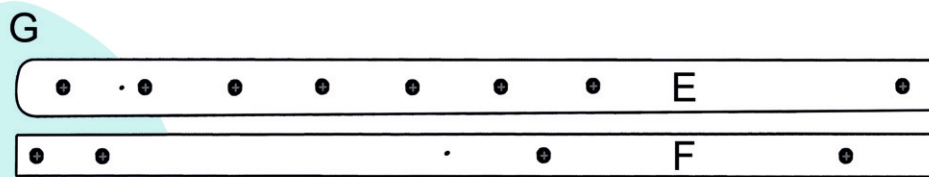

Step 5

Use knob screw (d) and allen screw (large) (b) to fix frame E with frame D as shown below.

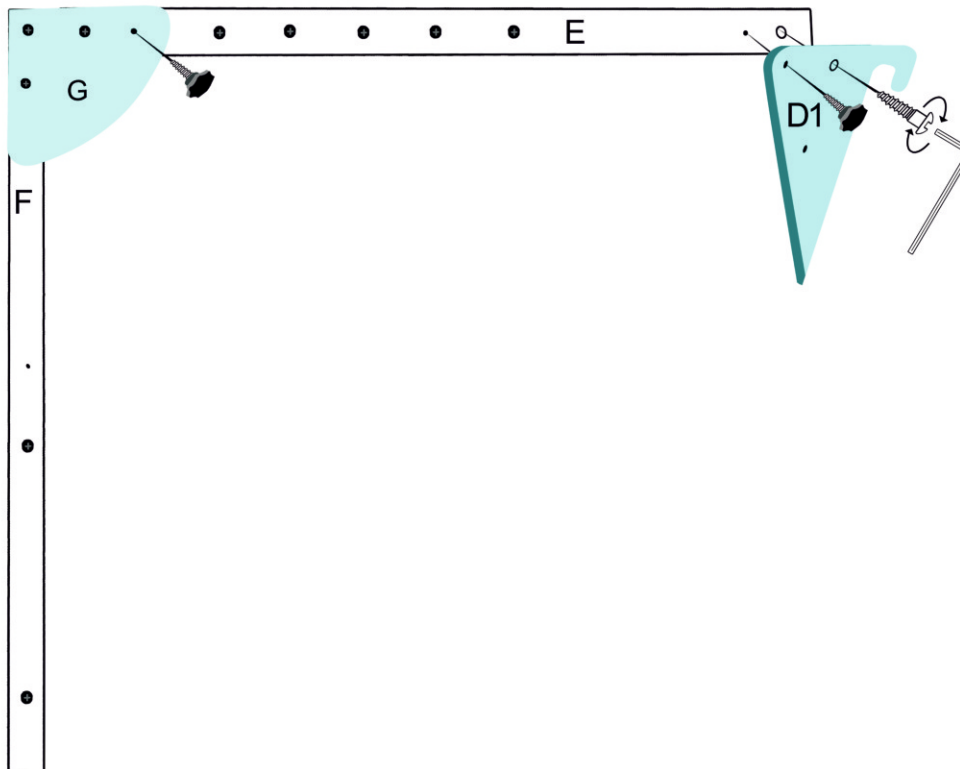

Step 6

Hook the entire structure D-E-F-G on to the wall mounted frame as shown below.

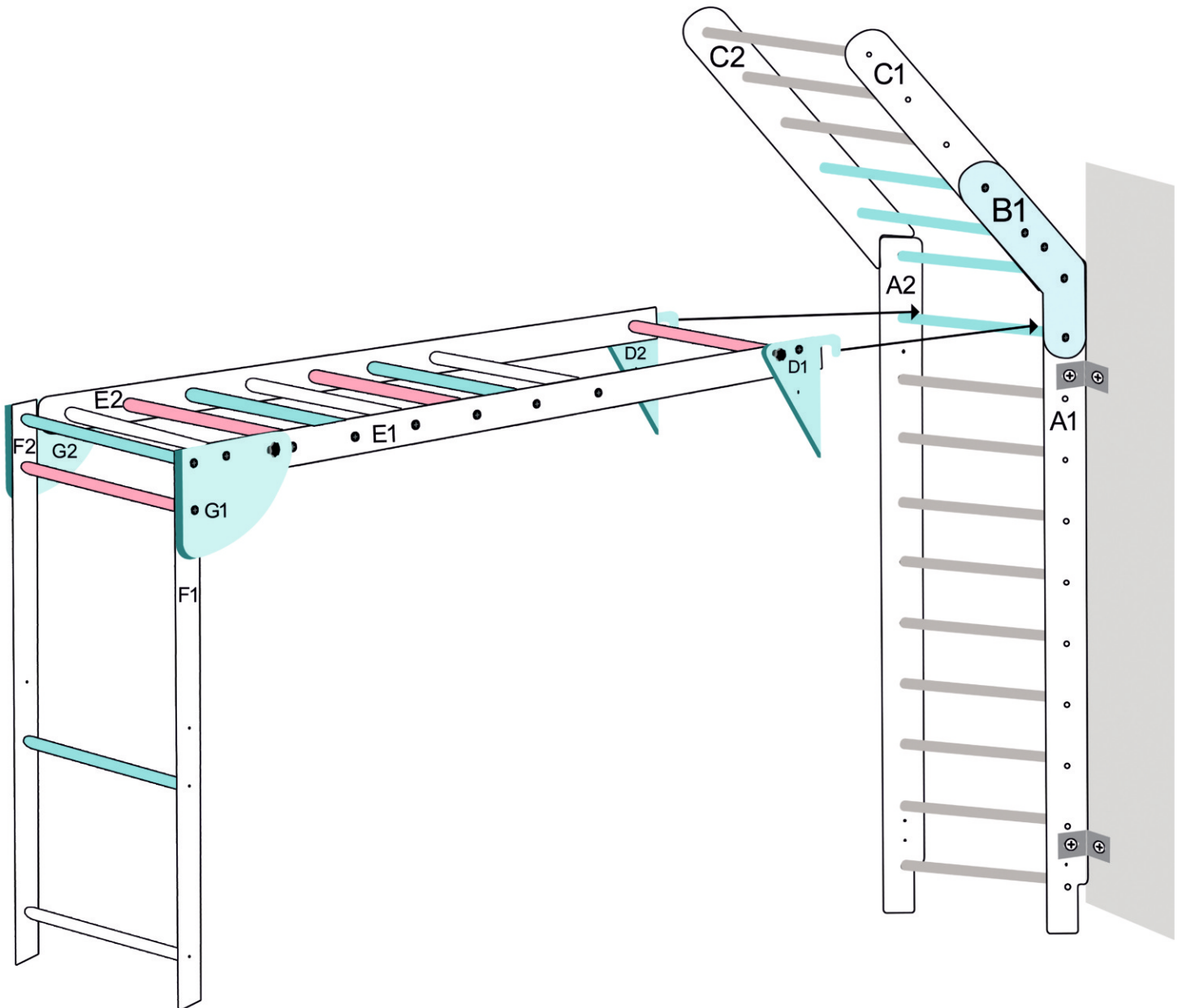

Step 7

Open the small ladder-platform structure and fix the angle using the knob screw (d) as shown below.

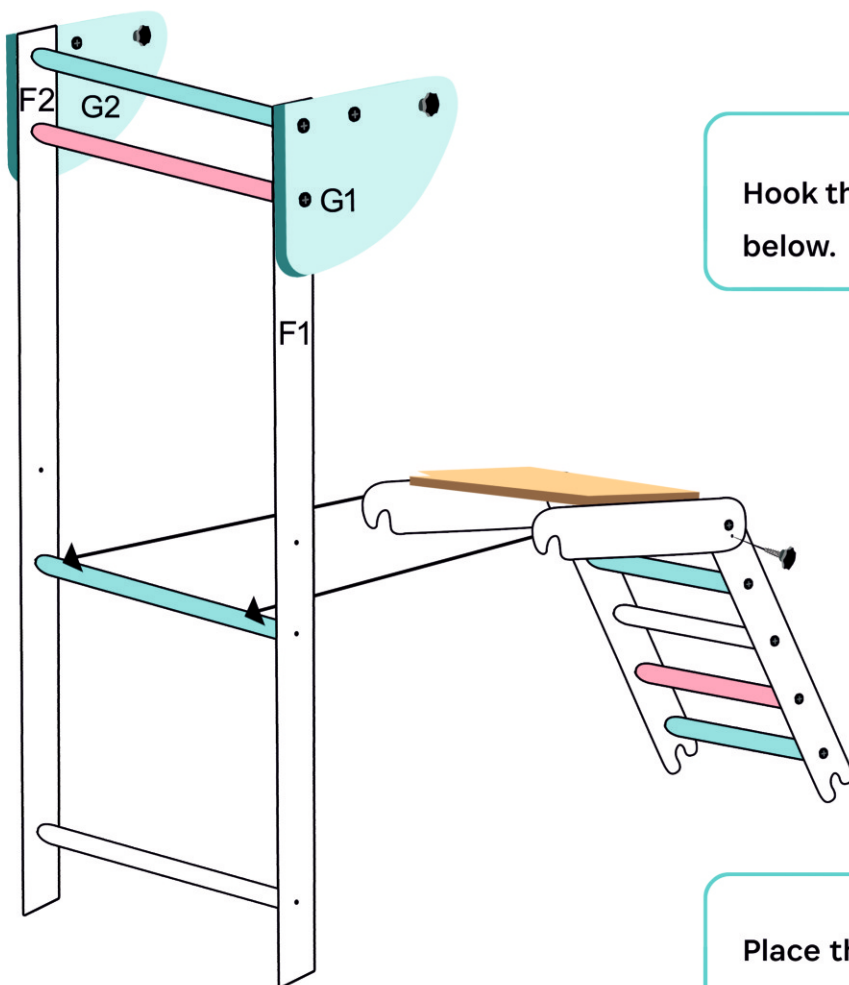

Step 8

Hook this structure to the frame as shown below.

Step 9

Place the slider cum mountain climber on to the rods in F1-F2 as required.