

Off Grid Inverter

User and Installation Manual

SDP-20KW



Please strictly abide by the warning and operating instructions in the manual and machine, properly keep this manual well.

Before not read all safety and operation instructions, please don't operate the machine, otherwise it will damage to the equipment and cause personal safety accident.

Content

1 Safety Instructions.....	6
2 Production Introduction.....	9
2.1 Summarize.....	9
2.2 Product Introduction.....	9
2.3 Technical Description.....	10
2.3.1 Working Principl.....	10
2.3.2 Derating.....	11
2.3.3 Product Feature.....	12
3 Inverter Unpacking.....	13
3.1 Unpacking Check.....	13
3.2 Identify Inverter.....	13
4 Installation Procedure.....	14
4.1 Prepare Installation Tools.....	14
4.2 Installation Steps.....	15
5 Installation.....	16
5.1 Installation Site Required.....	16
5.2 Installation Direction.....	16
5.3 Installation of Inverter.....	17

5.4 Notice.....	18
6 Electrical Connection.....	19
7 LCD Panel Operating Instructions.....	21
7.1 LCD display description.....	21
7.2 Indicator of LED light function.....	21
7.3 Fault Code.....	22
7.4 LCD Display Interface Overview.....	22
8 LCD Panel Operating Instructions.....	23
9 Malfunction and Troubleshooting.....	28
9.1 Troubleshooting.....	28
9.2 Maintenance.....	29
10 Warranty Conditions.....	31
11 Technical Parameters	32

Preface

Manual Instruction

This manual includes the description regarding the troubleshooting in process of transportation, installation, maintenance and operation of the following SDP-xx inverters:

- SDP-20KW

In order to describe convenient later, SDP-20KW Off grid inverter will be short for inverter. When introduce the information about each inverter type in detail, pointed out the inverter type alone.

Target Reader

This manual applies to the inverter installation person and professional engineering technology person of operation and LCD interface operation person.

Use the Manual





Please read this manual carefully before starting installation and operation. Please keep this manual for operation and maintenance in future.

The manual content will continue to update, amend, but unavoidably exist slightly discrepancy or error with material object. Users to purchase products, please kind prevail.







Symbol Used

The following safety symbols may be used in this manual, they represent the meaning of below.

Off Grid Inverter

Safety Symbol	Meaning
 Danger!	If ignore the security warning, it may lead to serious accidents of injuries.
 Warning!	If ignore the security warning, it may cause serious injury accident, equipment damage or major business interruption risk.
 Notice!	If ignore the security warning, it may cause moderate injury accident, moderate damage to the equipment or part of the risk of business interruption.
 Note!	The content is the body of the additional information.

Symbols on the inverter:

Symbol	Meaning
	Ground Protection
	Refer to related instructions
	Cannot discard the inverter together with waste of life.
	Beware of dangerous electrical voltage. The inverter operates at high voltages!
	CE mark The inverter complies with the requirements of the applicable EC guidelines.
	SAA mark The inverter complies with the requirements of the applicable Australia guidelines.

1. Safety Instructions

For electrical and electronics equipment, security is concerned with the whole process of installation, commissioning, operation and maintenance. Therefore, incorrect or wrong operation will damage the operator or third party's life or safety, or the inverter equipment. In order to reduce the casualties, inverter and other equipment damage, operation and maintenance process must strictly abide by all of the following danger, warning, and pay attention to the safety information such as tips.

Warning !

All the installation and operation of SDP-XX series inverter must be finished by professional technical person.

- Receive special training.
- Complete to read this manual and master related safety attentions of operation.

Any damage to the equipment caused due to failure to comply with the descriptions in this manual in installation or operation will be beyond the scope of the company's quality guarantee.

Before installation

Notice !

When received products, need to check the inverter if there is any damage during transportation, and if found the problem please immediately contact us or contact transportation company.

Installing

Before installing inverter, make sure the inverter not have electrical connections and electricity.

Danger !

The solar cell arrays should be covered with opaque materials when installing the photovoltaic arrays during the day, otherwise the solar cell arrays will generate high voltage, causing person casualties.

Warning !

If inverter installation environment improper selection, it will affect the machine performance and may cause machine damage.

Don't install the inverter in inflammable, explosive place or inflammable, explosive materials storage.

Don't install the inverter in explosive dangerous place.

Don't install the inverter in place where vulnerable to lightning strike.

Don't install the inverter in place where have more salt fog.

Danger !

Before electrical connections, ensure that the solar cell arrays are covered with opaque materials, otherwise the solar cell arrays will generate high voltage, causing person casualties.

Electrical connections

Warning !

All the operating and wiring work should be operated by professional electrical or mechanical engineer.

Warning !

When running inverter, need ensure well-ventilated.

Inverter should be upright installed and ensure heat sink, fan etc. without shelter.

Warning !

Please don't open any breakers before all equipments are not completely connected well.

Notice !

All the electrical installation must meet the electrical installation standard of local and country.

Warning !

Please don't open any breakers before all equipments are not completely connected well.



Notice !

In order to make sure safe running, ask for proper grounding, using appropriate conductor size and providing short circuit protection.



Notice !

Connection cable must selection suitable specification, firm connection and good insulation.

Running



Danger !

Under AC side of inverter take with loads, can't directly break DC connection, need cut off the inverter start switch firstly and break AC output breaker, ensure that it has no voltage in AC side, then can break DC connection.



Danger !

Please don't connected any terminal connectors under inverter charged state!
Please don't open the cover plate under inverter charged state!



Notice !

When the inverter is running, only LCD display screen and front panel DC switches, AC switches, start switch can be touched, can't touch the heating devices (such as radiator, etc.) to avoid scald.

Maintenance



Danger !

Maintenance work must be done by professional maintenance technical person.



Danger !

Before checking and maintaining, please must break Start switch, AC side breaker, then break DC side breaker, after waiting 5 minutes, measured DC side and AC side voltage with a multimeter, ensure that have no voltage between DC side and AC side to operate.

2. Product Introduction

2.1 Summarize

Our SDP series off grid inverter is one of the most advanced DC to AC conversion products in the world, it is suitable use for areas without electricity, backup batteries system, solar energy, wind turbine and other renewable energy systems etc, can supply power and provide guarantee effectively for the areas with traffic inconveniences, in the mountains, pastoral, border, island and other areas without electricity. It has the main advantages of high quality sine wave AC output, microcomputer control, humanness design, and it is high efficiency and low no-load loss, and no pollution. The inverter can also supply AC power to all kinds of electric equipment, air conditioners, electric motors, refrigerators, fluorescent lights, televisions, electric fans and other industrial power supply.

2.2 Production Introduction

2.2.1 Production Appearance

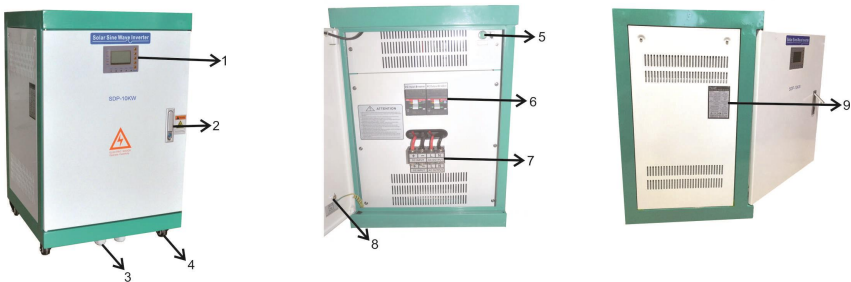

Figure2-1 Appearance of SDP off grid inverter

Table2-1 Inverter appearance information table

No.	Name	Introductions
1	LCD display screen	Man-machine interface, you can check the converter operating information through LCD display screen, also can set some function and parameters of converter.
2	Lock	The lock of converter used to open and lock
3	PG Cable Glands	The input wire and output wire through this cable glands
4	Wheels	Wheels for moving the converter
5	Start switch	Used to Starting and break the converter
6	Breakers	AC input breaker and AC output breaker
7	Connection terminals	Including AC input terminal; AC output terminal;
8	PE(grounding)	Earth wire of cabinet
9	Name plate	converter basic parameters listed on the nameplate for basic information about converter.

2.2.2 Product Name

The way of product naming, take SDP-20KW for example:

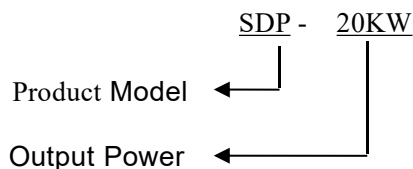

2.3 Technical Description

2.3.1 Working Principle

The principles of SDP series off grid inverter please refer to the schematic below.

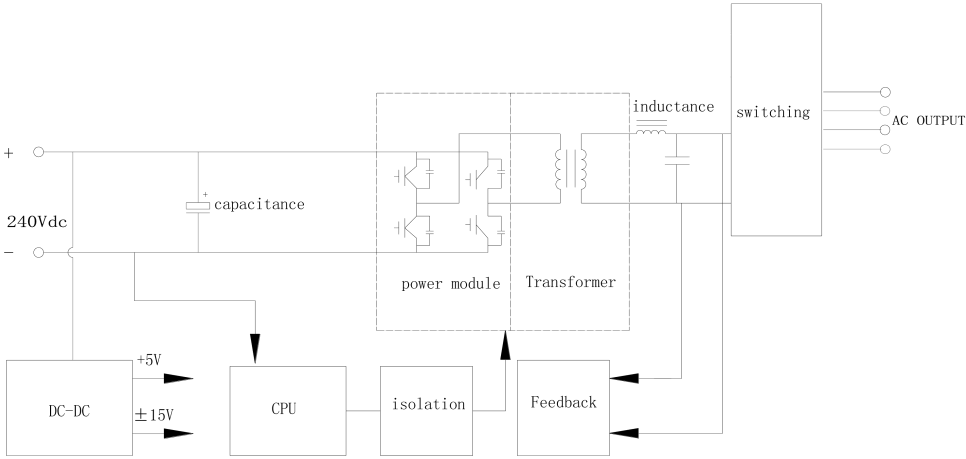

Figure2-2 Internal circuit structure diagram of SDP off grid inverter

2.3.2 Derating

Reduce the output power is a way to prevent inverter overload or some potential problems. When the operating environment temperature and altitude are too high, both can cause inverter derate operation.

Environment temperature too high

Inverter temperature derating curves in below

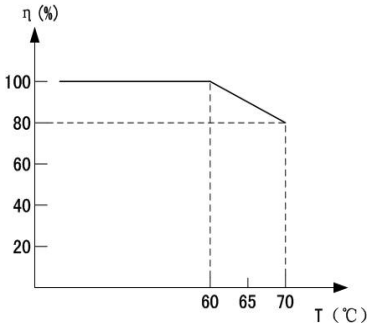

Figure2-3 Inverter temperature derating curve

$$\eta = \left(\frac{P_{out}}{P_{nom}} \right) \times 100$$

T is environment temperature

P_{out} is the off grid inverter actual max. output power

P_{nom} is the off grid inverter allowed max. output power

2.3.3 Product Feature

- ◆ Using the sixth generation efficient IPM intelligent module from Japanese Mitsubishi, high efficiency and stable performance. It with powerful protection function for short circuit, over load and over temperature which is more safe and reliable. It's service life can up to 15-20 years or more.
- ◆ Intelligentized, modularized and simple structure design, very easy and convenient for maintenance.
- ◆ Two kinds of start mode: Step Down Voltage Start and Variable Frequency Start. Customer can set start mode according to the type of their load. This function is very convenient for users and also reduce frequency converter's usage, save more cost and easy to connect wires and control.
- ◆ The output frequency 50Hz/60Hz can be set via LCD panel.
- ◆ The output voltage can be set between -40 % to +20 % of rated voltage. And the accuracy of output voltage is very high less than 1%.
- ◆ The DC input voltage range can be set. over-voltage point, under-voltage point, over-voltage recovery point, under-voltage recovery point and under voltage recovery time all can be set via the LCD panel. Convenient for increasing or reducing the quantity of batteries and solar panel in the future.
- ◆ Using SVPWM space vector algorithms, high conversion efficiency, high instantaneous power and low losses, higher efficiency > 94%.
- ◆ Pure sine wave output. with good transient response less than 50MS, little harmonic distortion, higher conversion efficiency and stable output voltage.
- ◆ Low frequency transformer, which ensure the AC busbar and DC busbar are completely isolated to avoid interference, high efficiency and very little no-load loss.
- ◆ Powerful data display and fault instruction function. LCD can display the DC input voltage, output frequency, phase voltage, phase current, AC bypass input voltage, output power KWH, time and date, temperature, fault code display.
- ◆ Wide input voltage can be set according to customer's requirement. Input voltage range can be selected from 100-400v or 200-600v or 400-850v. This

wide voltage input off grid inverter can work without battery and solar charge controller, which save battery cost and same like with MPPT function can maximum make full use of solar power.

- ◆ AC bypass input function optional: Battery Power Priority or AC Bypass Priority work mode can be set.
- ◆ RS485 remote monitoring function optional
- ◆ Solar charge controller and AC to DC battery charger built in optional for customer
- ◆ Can be customized to customer's specification.
- ◆ European CE (EMC and LVD) certification, accredited by Australian CEC, ERAC energy network.

3. Inverter Unpacking

3.1 Unpacking Check

The product has been tested and checked carefully before transportation, but damage may be caused during transportation, therefore, the product should also be checked carefully before installation.

- Please check whether inverter outer packing is in good condition;
- After unpacking, please check whether the equipment is in good condition;
- According to the packing list to check whether all the parts is correct and in good condition.

If any damage is found, please contact us or the transportation company. Please keep well the photos taken at the damaged parts and we'll provide you with best and fastest services.

3.2 Identify Inverter

There is nameplate in the side of inverter, the nameplate shows the inverter model, some important parameter and certificate mark.

Pure Sine Wave Inverter		
Model	SDP-20KW	
DC Input	Rated voltage	350Vdc
	Voltage range	300~400Vdc
AC Input	Rated voltage	120/240V split-phase
AC Output	Rated power	20KW
	Rated voltage	120/240V
	Phase	Split-phase 3 wires
	Rated current	83.3A
	Frequency	60Hz
Protection degree		IP20
Operating temp range		-25℃~50℃
Serial number		SDV20180404US
Production date		2018.04.14

Figure3-1 Inverter nameplate

NO.	Description
1	Product name
2	Inverter model and parameter information
3	Inverter factory number
4	Certificate and safety signs, concrete meaning as “Preface”

Table3-1 Nameplate information table

Note! Photos are for reference only, please adhere to the original products!

4. Installation Procedure

4.1 Prepare Installation Tools

Before installation, need to prepare first.

Inverter installation and wire installation will need the following tools.

You also can choose the right tools according to your own experience



Sketch map	Name	Recommend specification	Function
	Wire crimpers	6~50mm ²	Used for crimping input and output terminals connected to the wires
	Cross screwdriver	Φ8	Used for the input and AC output wires installation

Table4-1 Installation tools list

4.2 Installation Steps

Tools ready, follow these steps to install

Installation steps	Installation instruction	Reference chapters
1	Before installation, check whether the inverter is in good condition;	
	Whether the product fittings are complete	
	Whether the installation tools and spare parts are complete	4.1
2	Whether the installation environment meets the requirements	1
	Read the manual, especially the "safety instructions"	1
3	Choose the best installation location	5.1
	Installation	5.2
4	Electrical Connection	
	DC side wire connection	6.1
	AC side wire connection	6.2
5	Configuration parameter	10
6	Troubleshooting	9

Table4-2 Installation process table

5 Installation

5.1 Installation Site Required

Inverter installation site environment has very important influence to the safe operation, the performance and life of the inverter. Install the inverter before, need to choose the right installation site.

- All installation must comply with local standards.
- Do not install the inverter at a flammable or explosive place or a place where the flammable or explosive materials are stored.
- Do not install the inverter in a place where there is a risk of explosion.
- Do not install the inverter in places where the inverter is vulnerable to lightning strike.
- Do not install the inverter in a higher salt spray environment
- Inverter installation site must be in good ventilation, do not install the inverter in the case closed, otherwise the inverter will not work properly.
- Inverter protection level is IP20, can be installed indoor, when the inverter is installed indoor, should be installed as far as possible in the eaves or other have the shadow place, avoiding direct sunlight, rain and snow.
- Inverter is installed indoor, keep away from Windows, avoiding lightning
- The installation place selected should be solid enough to support the inverter weight for a long period.
- The site for inverter installation must be clean and the ambient temperature must be maintained within -25 to +50°C.
- Inverter installation site relative humidity should not be more than 95%, water vapor may corrode inverter, and damage the internal components
- The inverter must be installed in a place convenient for observation and maintenance
- Don't install the inverter in living area, the inverter will produce some noise when running, influence daily living.

5.2 Installation Direction

- The inverter should be installed vertically.
- Do not install inverter tilted forwards.
- Never install the inverter horizontally.
- The installation place of inverter should be convenient for operation and reading out of the LCD displayed information
- Do not install the inverter in a place where children can touch.
- The inverter uses fan cooling mode and the installation site selected should ensure the minimum installation spacing between the inverter and the fixed object and the nearby inverters to ensure an good ventilation. And in front of the inverter need to keep enough space, is convenient to check the LCD display information.

5.3 Installation of Inverter

5.3.1 Check the front panel breakers are in "OFF" state, check whether there is a short circuit on load.

5.3.2 DC input cable must be through from the DC input terminals, correctly connect to the positive and negative pole of the machine, attention can't be reversed.

5.3.3 Absolutely prohibit DC input power supply connect to the inverter output terminal.

5.3.4 The connection cable between the battery and inverter should be as short as possible, otherwise the harmonic leakage current from cables will be harmful to inverter and the system equipment.

5.3.5 System grounding terminal must be grounded, and make the ground wire's length as short as possible. Do not allow welding machine, motor and other high current device in this system common ground. Ensure all system's ground wires are separately layout from high current electrical equipment.

5.3.6 Be careful of the positive pole and negative pole of battery input, which can't reverse.

5.3.7 Turn on the DC input breaker, if the breaker happen to the trip at the first time, it's a normal phenomenon, because the capacitor is charging.

5.3.8 Please don't turn off DC input breaker under the inverter with load, otherwise it will cause DC input breaker damaged.

5.3.9 When the machine happen MOD, overload fault alarm, turn off the DC input breaker to restart the machine.

5.3.10 Put the inverter on ventilated and away from sunlight, confirmed the machine and wall distance is greater than 30cm.

5.3.11 Don't block the vents, if found the vents blocked, please clean up in time.

5.3.12 When the inverter is running normally and temperature is rising. If the fan stop working, please replace the fan in time. (The starting temperature of the fan is 45°C).

5.3.13 Recommend to turn on the output circuit breaker firstly, then turn on start switch. Make the inverter starting load, can effectively avoid the damage of large inrush current to the machine.

5.3.14 Don't connect ground wire (PE) of cabinet and neutral wire (N) together.



Note!

Please don't break the DC Input Breaker often, otherwise it will cause will cause DC input breaker damaged. If you want to shut down the inverter, just need turn off the AC output breaker and Start switch. If you have to turn off the DC input breaker, please turn off the start switch, then AC Output Breaker to make inverter stop working, then turn off the DC Input breaker.



Notice !

Never connect several inverters in parallel output!



Danger !

Ensure that all cables are not charged before electric operation!

5.4 Notice

5.4.1 All operations of equipment must be done by professionals, please remove metal jewelry on hands before the operation in case of electric shock !

5.4.2 The inside cooling fan of the machine is controlled by temperature, it's a normal phenomenon that the fan is not running when inverter just start soon or taking little load, the fan only will run when cabinet internal temperature exceeds 45 °C.

5.4.3 When the machine is working, in case of accidents and to avoid electric shock, please don't open the cover of cabinet.

5.4.4 Please don't make change to the circuit line privately when regular checking, in case of damage.

5.4.5 It's a normal phenomenon that the inverter has a certain degree of fever during the use process, but should keep the environment of installation ventilated, cooling and clean, especially can't block air ventilator.

5.4.6 The inside all CMOS components of the machine can't touch, when the circuit is powered on don't connect or disconnect the wires and terminals.

5.4.7 After connect all wires, please must be carefully check (voltage value, positive and negative pole are consistency, grounding is well).

5.4.8 Even if the all switch on the panel is OFF, but inverter's part of capacitor still electric, please don't touch.

5.4.9 When take with motor and pump or other inductive loads, the inverter had best leave 30% of the power margin, should be considered the impact current to the machine, to ensure reliable power supply to inverter

6 Electrical Connection

The electrical connection should be carried out immediately when the installation is completed. When making electrical connection, special attention should be paid to the following operating specification:



Warning!

- All the electrical connection must meet local electrical connection standard.
- Only qualified electrical personnel can perform the wiring installation work.
- Incorrect wiring operation may cause operating casualties or equipment damage permanently.

- Before electrical connection, please make sure that the AC side and DC side are uncharged!
- Ask for correct grounding, using appropriate conductor and providing necessary short-circuit protection to ensure safe operation.
- Please don't turn on any breakers before all the equipment unfinished connection.

6.1 Connecting Terminals of inverter

The input and output terminals are installed in the bottom of the inverter and include DC side input terminals and AC side output terminals.

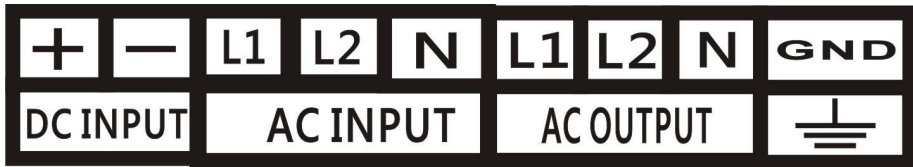

Figure6-1 Connection terminals on inverter

Table 6-1 Terminals Description

Terminals	Description
+	Battery positive input terminals
-	Battery negative input terminals
L1,L2, N	AC Input terminals, connect with AC grid
L1,L2, N	AC Output terminals, connect with AC load
PE	Earth Wire



Warning!

The positive and the negative mustn't be misconnected.

7. LCD Panel Operating Instructions

7.1 LCD display description

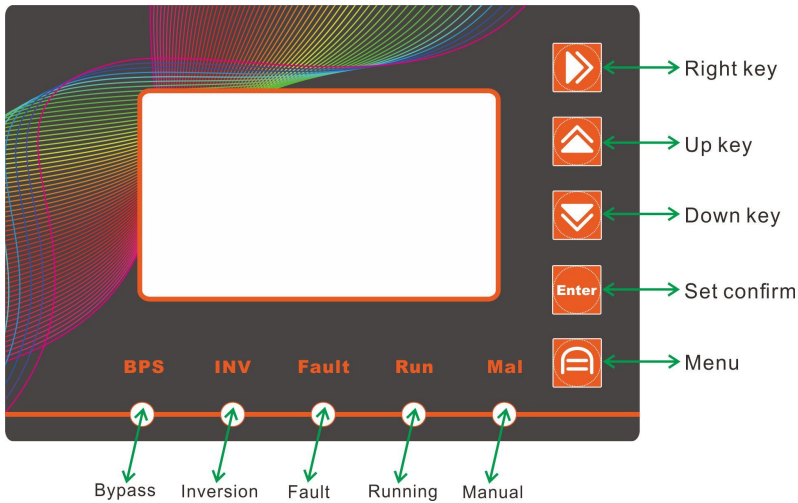

7.2 Indicator of LED light function

There has 5 LED lights in the panel: BPS, INV, Fault, Run, Mal.

LED Indicator	Name	Color	Instructions
BPS	AC Running Light	White	AC bypass priority mode, it indicates the AC grid/generator input condition.
INV	DC Running light	Green	Battery priority mode, it indicates the battery input condition.
Fault	Faulty light	Red	System fault.
Run	Power light	Blue	Inverter running, it indicates the inverter work normally.
Mal	Manual Start Mode	Yellow	This light is only applicable for our SPI series solar pump inverter, when start mode is Manual Start then this light will on

Table7-1 LED Indicator Direction

7.3 Fault Code

DCU OVER	DC over-voltage
DCU UNDER	DC under-voltage
OVER LOAD	Current over-load
MOD	Module error
OUTErr	Output voltage unbalance (This error only for 3 phase output, single phase output without this error display).

7.4 LCD Display Interface Overview

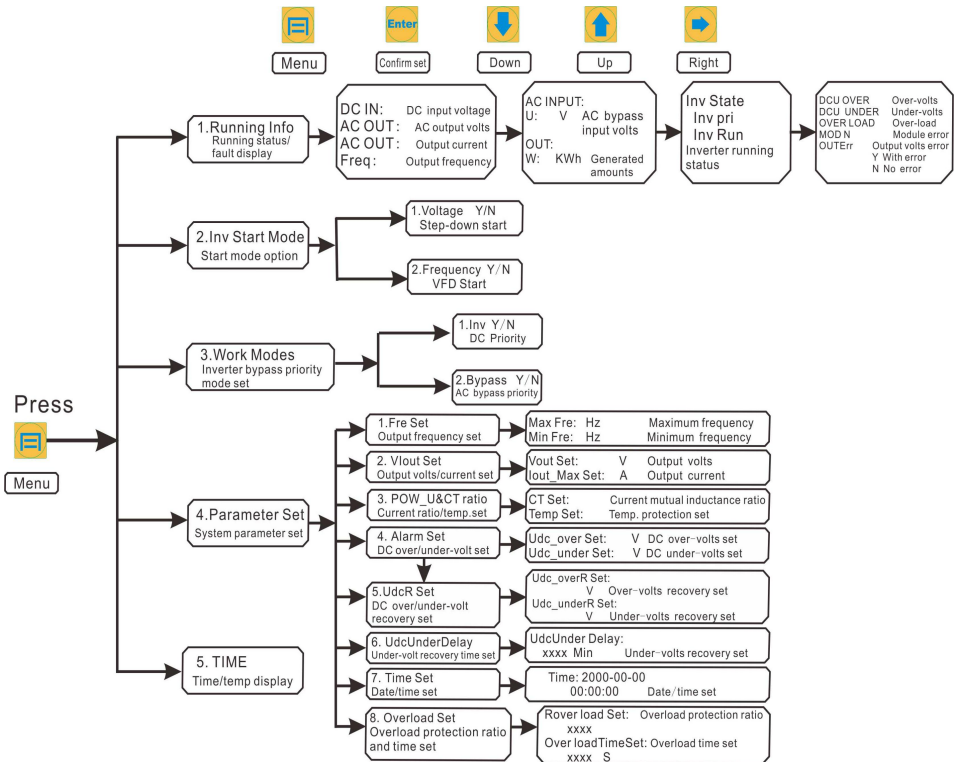

8. LCD Panel Operating Instructions

Inverter power on, the first interface display parameter, press “down” key to display as following 4 item

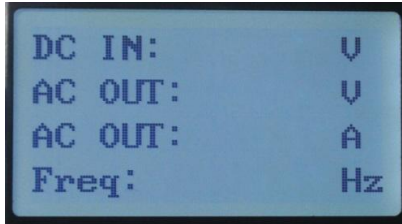

DC IN DC input voltage display
 AC OUT AC output voltage display
 AC OUT Output current display
 Freq Output frequency display

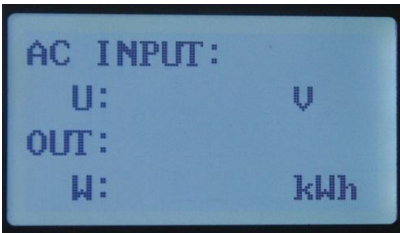

AC INPUT: AC bypass input
 U: V Bypass phase voltage
 OUT: Total generated amounts
 W: KWH Generated amounts

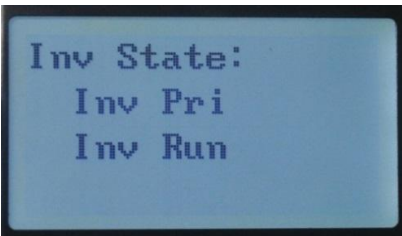

Inv State: Inverter working state

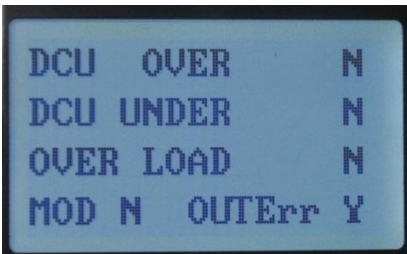

DCU OVER DC over-voltage
 DCU UNDER DC under-voltage
 OVER LOAD Over-load
 MOD Module error
 Fault display: "N" indicate no error,
 "Y" indicate with error
 OUTErr Output voltage unbalance
 ➤ This error only for 3 phase output, single

phase output without this error display

- ◆ Fault alarm can be divided into automatic recovery and non-automatic recovery: When the LCD screen display MOD error and overload, need to manually recovery, turn off the DC circuit breaker until the LCD screen is

Off Grid Inverter

completely extinguished and then turn on the DC circuit breaker; over-voltage, under-voltage can automatic recovery (the under-voltage recovery default setting is 10 minutes), can set according to the customer needs.

Keypad function

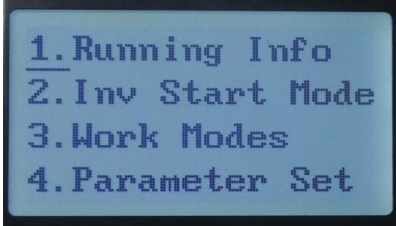

- 1. Running Info Running state display
- 2. Inv Start Mode Inverter Start mode
- 3. Work Modes Working Mode
- 4. Parameter Set System parameter setting

Press “ 2. Inv Start Mode ” display as following

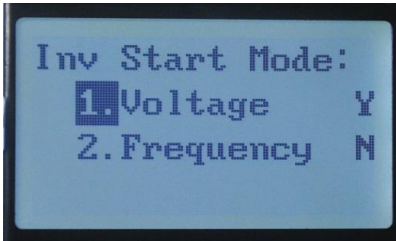

- 1. Voltage Constant frequency
step-down voltage Starting mode
 - 2. Frequency Variable frequency
starting mode
- Y : YES N: NO

Press “ 3. Work Modes ” display as following

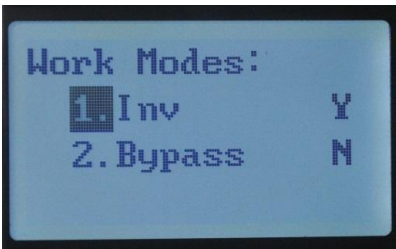

- 1. Inv Battery priority mode
 - 2. Bypass AC bypass priority mode
- Y : YES N: NO

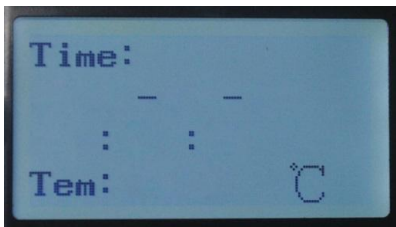

Time: Display current time and date

Tem: Environmental temperature display

Press “ 4. Parameter Set ” need to enter password.



Note! If you want to adjust the parameter setting, please contact the manufacturer ask for password

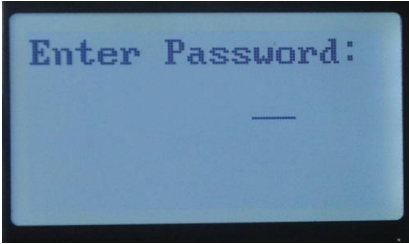

 **Note!** When inverter is working, please don't adjust parameters setting. If you want to adjust parameter setting, please turn off start switch, then operation.

The following settings only for professionals operation, the non-professionals can't change parameters, otherwise, you will undertake all damages caused by privately settings.



1. Freq Set Frequency setting
2. VIout Set Output voltage setting
3. CT&Temp Set Current ratio setting and temperature Protection setting
4. Alarm Set DC over-voltage and under-voltage setting

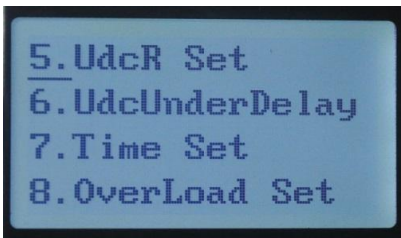

5. UdcR Set Recovery setting of DC over-voltage and under-voltage
6. UdcUnderDelay Default recovery time of under-voltage is 10 minutes
7. Time Set Date and time setting
8. Overload Set: Overload times and overload time setting

Press “ 1. Freq Set ” output frequency setting display as following

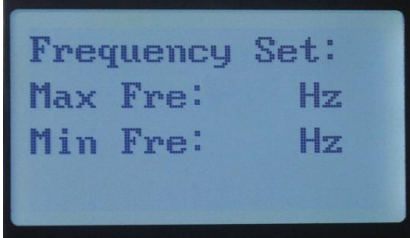

Max Fre: HZ Recommend maximum output frequency setting between 30-100Hz
Min Fre: HZ The minimum frequency of output Starting can't less than 5Hz

Press “ 2. Vout Set ” output voltage and current setting display as following

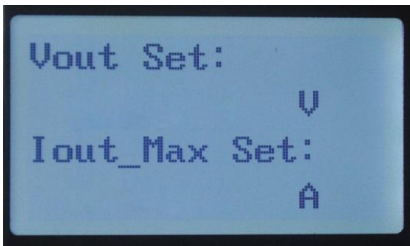

Vout Set Output voltage setting
Iout_Max Set: Output current setting
Noticed: Output Max Current default is overload protection current value, it can't be set. Output voltage set not more than 20% of the rated power, if the inverter damaged caused by wrong settings is beyond the scope of warranty.

Press “ 3. CT&Temp Set ” Current and mutual inductance ratio and Protection temperature setting display as following

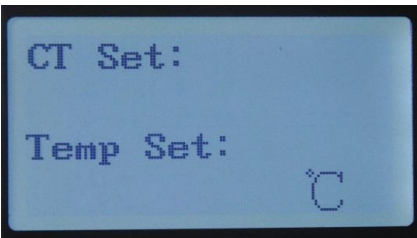

CT Set: Current and mutual inductance ratio setting
Temp Set: Protection temperature setting

Press “ 4. Alarm Set ” over-voltage and under-voltage setting display as

following

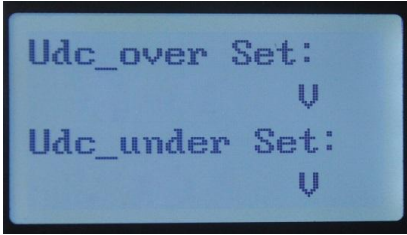

Udc-over Set: DC over-voltage protection setting

Udc-under Set: DC under-voltage protection setting

Press “ 5. UdcR Set ” DC over-voltage and under-voltage recovery setting display as following

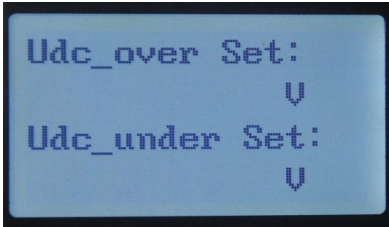

Udc-over Set: DC over-voltage recovery setting

Udc-under Set: DC under-voltage recovery setting

Press “ 6. Udc Under Delay ” Under-voltage recovery time setting display as following

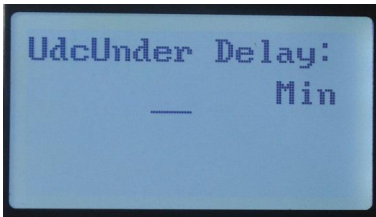

Udc Under Delay: Under-voltage recovery time setting

Min Minute

Press “ 7. Time Set ” to display as following

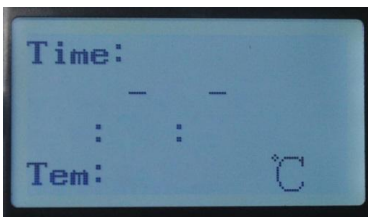

Time: Display date and time setting

Temp Set: Protection temperature setting

Press “ 8. Over Load Set ”

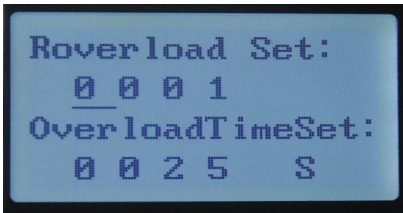

Rover Load Set: Overload times setting

Over load Time Set: Overload time setting

9 Malfunction and Troubleshooting

9.1 Troubleshooting

Once malfunction or stop condition arise, the malfunction LED will light up, LCD will display current malfunction or stop condition, please refer form below for classical malfunction and troubleshooting.

Condition code	Name	Phenomena	Cause value	Troubleshooting
State 01	DC input voltage low	Inverter stop working, malfunction disappear, system restart automatic		Check battery output voltage, ensure the output voltage within arrange of inverter.
State 02	DC input Over voltage	Inverter stop working, malfunction disappear, system restart automatic	DC input voltage higher than maximum input voltage of inverter	Check battery output Voltage or PV array, ensure the output voltage within arrange of inverter.
State 03	Output overload	Inverter shut down, malfunction disappear, restart again.	Load higher than rated output power of inverter.	Please insure correct system design. This fault is usually caused by larger power of load. Please reduce the power of load.
State 04	IPM fault	Inverter shut down, malfunction disappear, restart again.		Please check if short circuit on AC output. If this fault appear frequently, please contact us.

Table9-1 Stop condition and trouble shooting

9.2 Maintenance

To ensure SDP series inverter continuously and normally running, it is required regular maintenance, usually every six months for regular inspections.

Before opening the cover of cabinet maintenance, should completely cut off the power and shut down inverter 10 minutes or longer, after capacitors end discharging, then can proceed maintenance (the machine inside has many capacitors and discharge need some time), be careful not to damage any parts and components, pay attention to the order of wiring.

Every half to one year, check the items below:



Warning!

This operation must be done with whole system is not charged with electricity.

- Check humidity and dust of inverter surrounding environment, if have too much dust, clean the inverter.
- Check the inverter cable connection is loose, if loose, tightening again according to the connection method of wire.
- Check whether the cable is damaged, especially the metal surface Contact surface is cut marks or not.

Parts	Check the contents	Solutions
Input and output terminals	loose	Tightening
Input and output cable	The cable whether is aging	Replace cable
Control board	Accumulation of dust and dirt	Using 392kPa-588kPa pressure dry compressed air to blow off
Bus capacitor	Discoloration or smell	Replace capacitor
Radiator Fan	Not work	Replace fan
Inside of cabinet	Accumulation of dust and dirt	Using 392kPa-588kPa pressure dry compressed air to blow off
Button cell	LCD doesn't display Time	Replace the CR1220 Button Cell on the motherboard

10. Warranty Conditions

Sales staff cooperate with Engineering department, delivery the products that meet the needs of users and be in good condition to the user. Terms are stipulated as following:

We usually adopt entrust transport way to delivered the goods, when the user sign for the goods by delegating transport, should carefully check whether the structure and appearance of product is damaged, if with doubt, the user shall not sign for it, if you sign for it then means you agree the goods without any fault or damage during transportation.

1. Our company seriously promised: for all sold out inverter, we provide one year warranty from the date of delivery and supply maintenance services all the time.

2. Within warranty time, when inverter meets all the installation environment and using conditions, also operation correctly, if the inverter have damage or accident happens, please inform our company after-sales service department, when contact us, please provide the equipment model, serial number and complete problem explanation. We will provide free components for replacement firstly, if the problems still can't be solved, please contact the manufacturer as soon as possible, prohibit remove the parts by yourself !

The factory warranty does not cover damages that occur due to the following reasons:

- Transport damage
- Incorrect installation or commissioning
- Failure to observe the user manual, the installation guide, and the maintenance regulations
- Modifications, changes, or attempted repairs
- Incorrect use or inappropriate operation
- Insufficient ventilation of the device
- have been modified, altered or operated with other components not approved by us;

- Force majeure (e.g., lightning, overvoltage, storm, fire)
- Have been treated improperly, negligently in any other inappropriate way (including use outside of the recommended ambient conditions).
- Are not operated in accordance with the operating manuals for their intended purpose;

Neither does it cover cosmetic defects which do not influence the energy production.

Claims that go beyond the rights cited in the warranty conditions, in particular claims for compensation for direct or indirect damages arising from the defective device, for compensation for costs arising from disassembly and installation, or loss of profits are not covered by the factory warranty, insofar we are not subject to statutory liability. In such cases, please contact the company that sold you the device. Possible claims in accordance with the law on product liability remain unaffected.

11. Main Parameters

Model		SDP-20KW
Isolation mode		Low Frequency Transformer
DC Input	Voltage range (Vdc)	300-420V
	Rated voltage (Vdc)	350V
	Rated current (A)	57.14A
AC Input	Rated voltage (Vac)	Split phase 120/240V
AC Output	Rated output power	20KW
	Output waveform	Pure Sine Wave
	Rated Voltage	120/240VAC \pm 3%
	Phases	Split phase + N + PE
	Rated current (A)	83.3A(phase current)
	Frequency	60Hz
	Power Factor (PF)	>0.95
	Inverter Efficiency	>92%
	Display	LCD
	Voltage Accuracy	Load Balancing \leq 1%, Unbalance Load \leq 5%
	Waveform distortion rate	\leq 2%(Linear load), \leq 3%(Nonlinear load)
	Dynamic Response	5%, \leq 50ms(load 0~100%)
	Running mode	Working continuously
Electrical insulation	2000Vac, 1 Minute	
Protection Function	Overload Ability	150%, 5 seconds
	Protection	Input reverse polarity, under voltage, over voltage, output over-current, short circuit, overheating etc.
	Cooling method	Fan-cooled
	Short-circuit protection	No automatic recovery, need to restart the machine
Working Environment	Noise (1 meter)	\leq 50dB
	Degree of protection	IP20(indoor)
	Working Altitude (m)	\leq 2000
	Working temperature	-25~+55°C
	relative humidity	0~90%, non-condensing
Mechanical Dimension	Width * Depth * Height	550x550x860mm
	Weight (Kg)	180Kg
Certification	European CE(EMC & LVD)	