

4

3

2

1

F

F

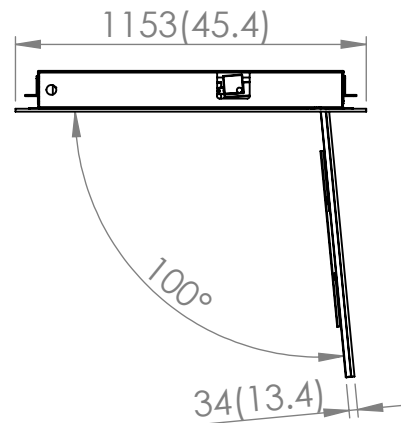
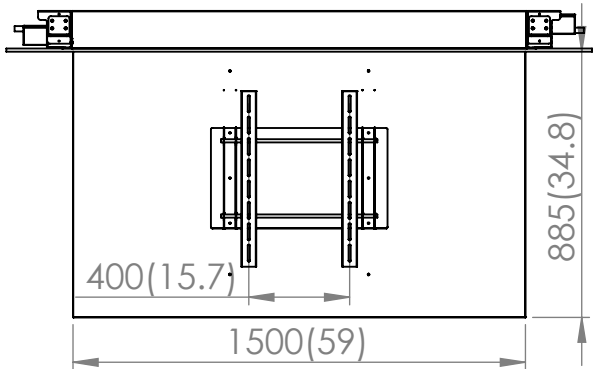

E

E

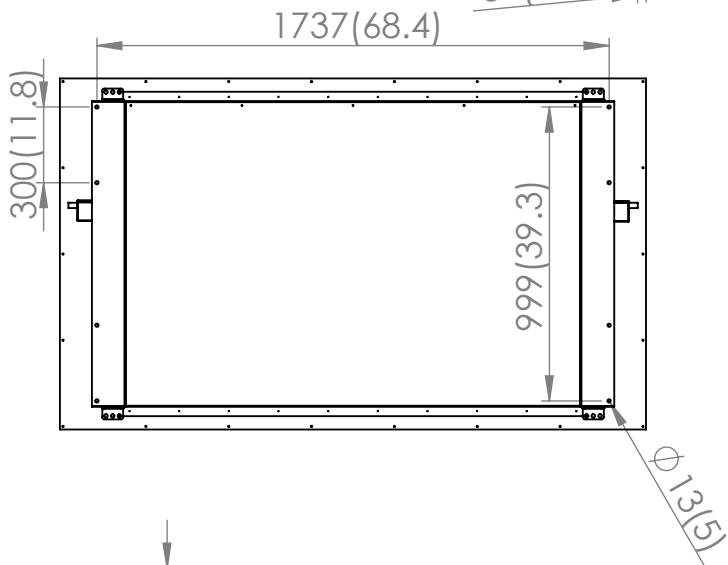
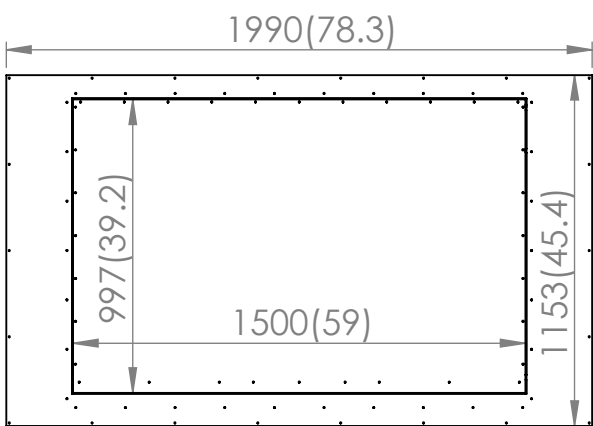

D

D

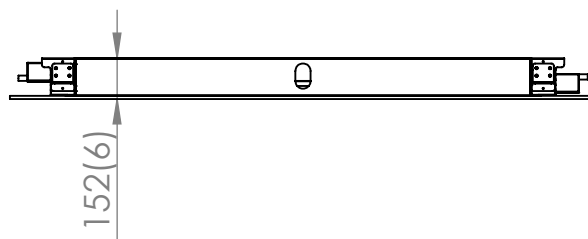
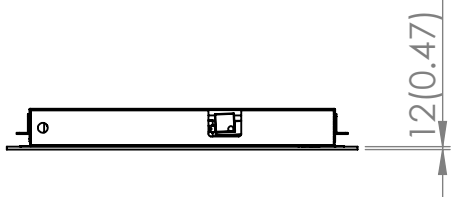

C

C

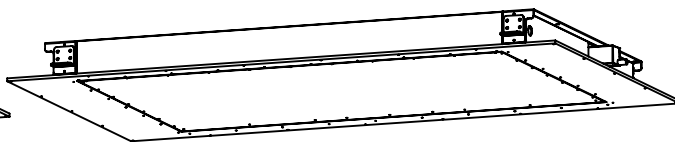
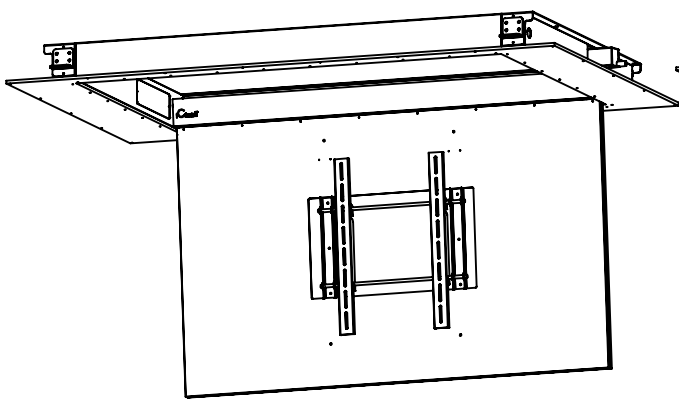

B

B

A

A

iCONNECT

Copyright 2004-2023 All Rights Reserved

iConnect Ltd ©

TITLE:

TVL-RH-65-2023

DWG NO.

A4

SCALE:1:50

SHEET 1 OF 1

4

3

2

1