

4

3

2

1

F

F

E

E

D

D

C

C

B

B

A

A

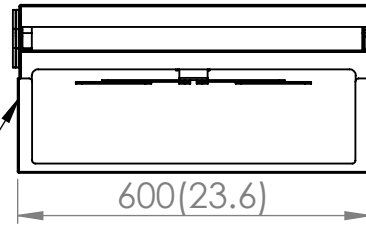
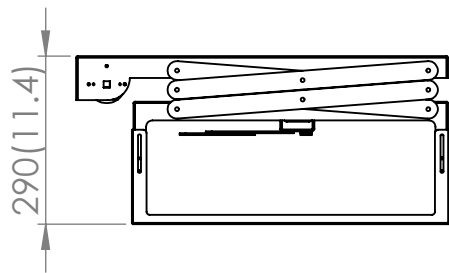
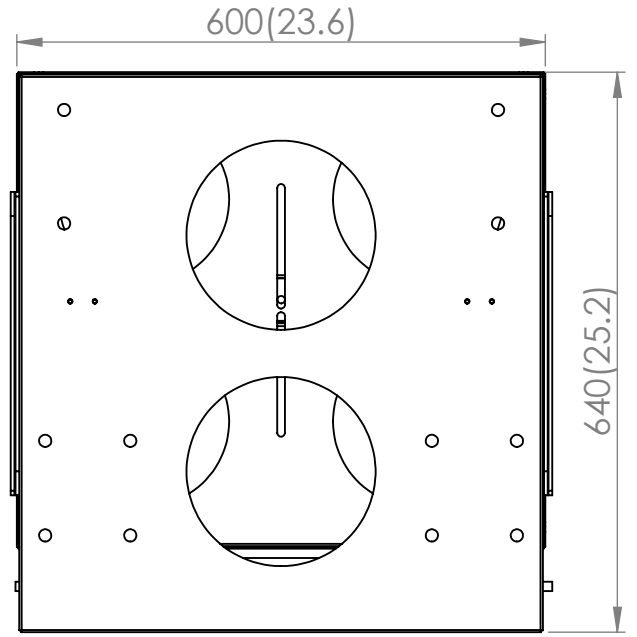
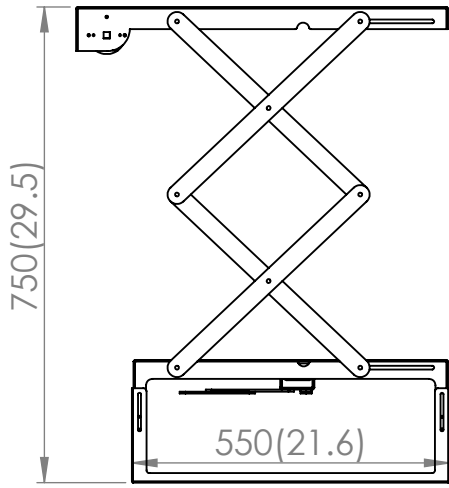

Max projector thickness 200mm (7.9)

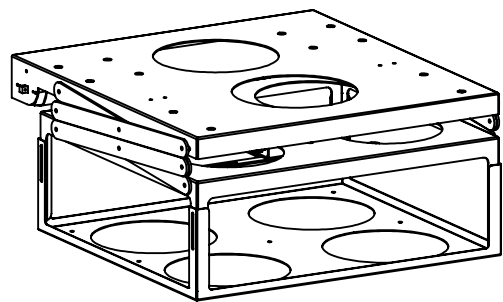
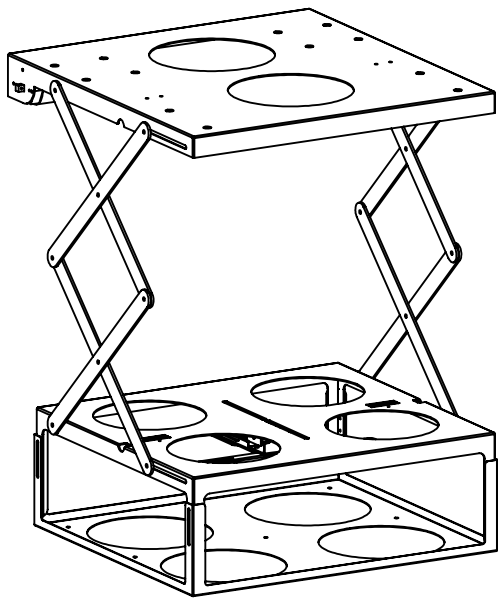

iCONNECT

Copyright 2004-2023 All Rights Reserved

iConnect Ltd ©

TITLE:

PRL-5560

DWG NO.

A4

SCALE:1:20

SHEET 1 OF 1

4

3

2

1