

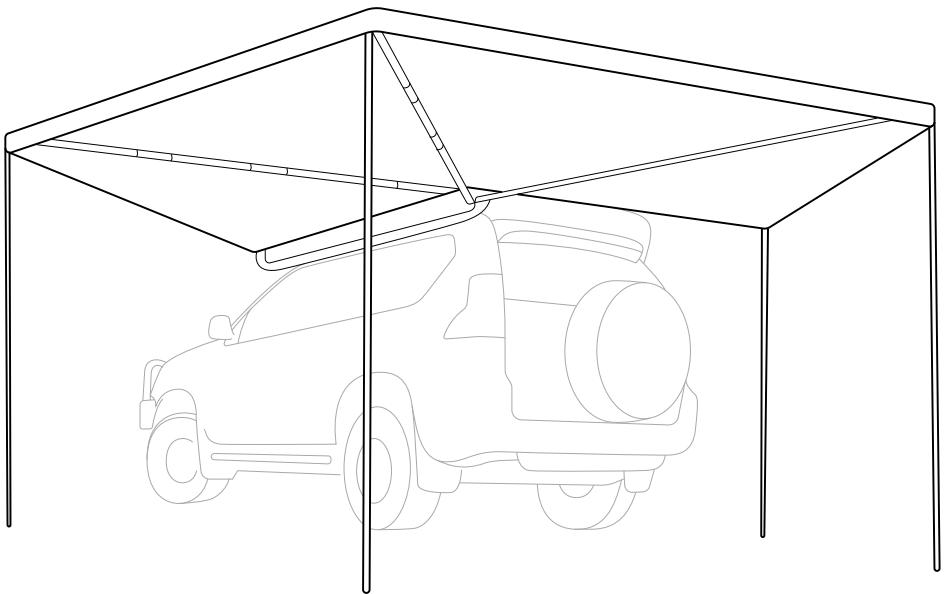

270° AWNING

INSTRUCTION MANUAL



KSA2000

INSTRUCTION MANUAL

CONTENTS

- 1 x 270° Awning with Transit Cover
- 3 x L-Mounting brackets
- 3 x Steel clamp plates
- 6 x M8 x 25mm bolt & nuts (Short bolts)
- 6 x M8 x 50mm bolt & nuts (Long bolts)
- 18 x Washers
- 8 x Guy ropes
- 8 x Pegs
- 1 x Tension strap

Before installing and using your awning please read the instructions and warnings below.

Should you have any questions or require assistance, please contact your Darche retailer or call our customer service line: 1300 367 695

Familiarise yourself with the awning; we recommend that you unpack and set up this awning at home before use.

Incorrect set up or use is not covered under general warranty.

Inspections: During trips regularly check that all nuts and bolts attaching your awning to your vehicle are tight and in good condition.

WARNING

Keep all flame and heat sources away from the awning.

Darche recommends fixing all guy ropes at all times when awning is in use.

Ensure sufficient awning fall for water run-off is provided.

Avoid using this awning in extreme weather conditions.



Scan to watch
the video

ATTACHING AWNING TO L-MOUNTING BRACKETS

It is recommended that this awning is set up with 2 people. Darche recommends using an experienced after-market 4x4 Accessories fitter to mount the 270° Awning to your vehicle. Fasteners and fixing connections should be checked regularly on both the awning and roof rack to ensure the awning is always mounted securely to your vehicle roof rack.

1. Slide the supplied 4x M8 x 25mm (Short bolts) into the grooves located in the aluminium backing plate.
2. Position the L-Mounting brackets onto the awning using the short bolts.

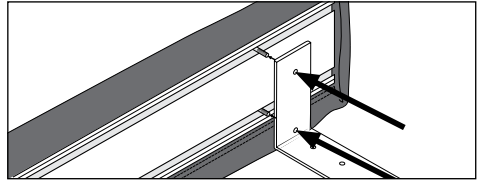
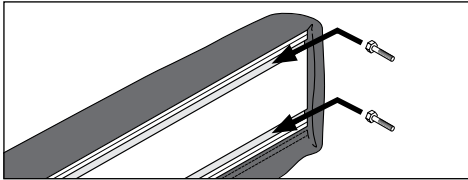

3. Align the L-Mounting brackets into desired position and tighten.
4. Recheck the tightness of nuts and bolts.

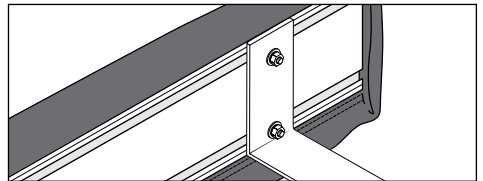
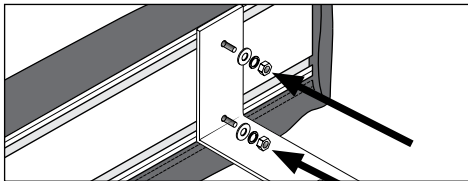

IMPORTANT!

AT THE HINGED END OF THE AWNING, ENSURE THE UNSUPPORTED SECTION OF THE AWNING DOES NOT EXCEED 250MM.

AT THE AWNING END WITHOUT HINGE, ENSURE THE UNSUPPORTED SECTION OF THE AWNING DOES NOT EXCEED 500MM.

PROLONGED TRAVELLING ON UNEVEN ROUGH OR CORRUGATED TERRAIN WILL REQUIRE MORE FREQUENT INSPECTIONS OF THE FIXING CONNECTIONS.

ATTACHING BRACKET TO ROOF RACK

Your Darche Kozi Series 270 Awning has been designed for a universal fit on most common roof rack and roof bar systems. It is advisable that you contact the manufacturer of the roof rack or roof bar system on your vehicle for the recommended attachments required for fitting this 270 Awning. Some roof racks are designed to allow direct fitting of the awning without the use of the L-Mounting brackets.

The 3 x L-Mounting brackets supplied are designed to attach to most roof rack and roof bar systems. This awning also comes with 3 steel plates for installing to a roof rack system.

DARCHE TAKES NO RESPONSIBILITY FOR THE FITMENT OF THE AWNING TO ANY VEHICLE OR ROOF RACK.

Tip: We recommend that you go for a short drive after attaching the awning to your vehicle, then recheck all fasteners & fittings. Check the position of the awning and brackets to ensure the awning is secure and adjust if necessary.

AWNING SET UP

Step 1 - Open/unzip the cover

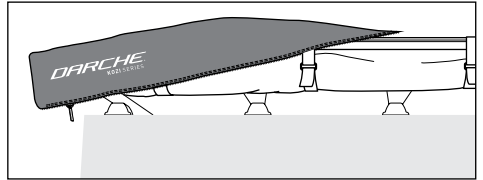
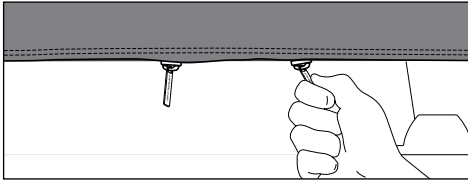

Unzip the transit cover and fold it back over the awning body.

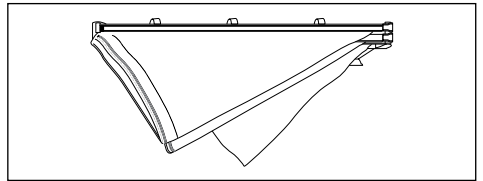
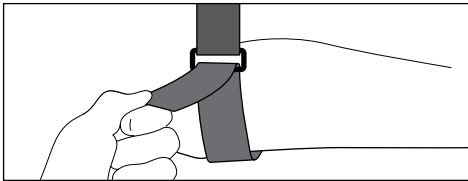

Step 2 - Release awning

Release the three hook and loop fasteners and allow canvas to drape.

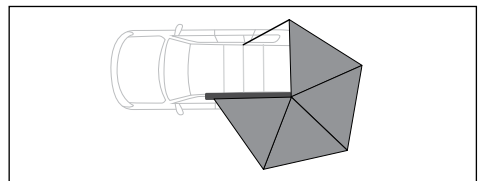
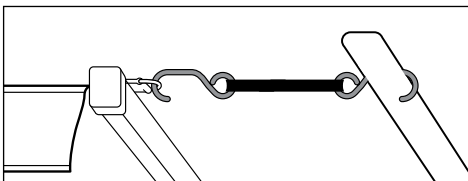
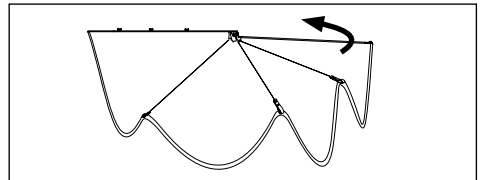
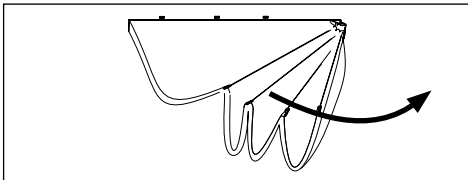

Step 3 - Open and secure

This awning will self-support during set up only. Extend the awning arms out fully, wrapping around the rear of the vehicle. Secure the rear awning arm to the roof rack using the tension strap.

INSTRUCTION MANUAL

Step 4 - Pole set up

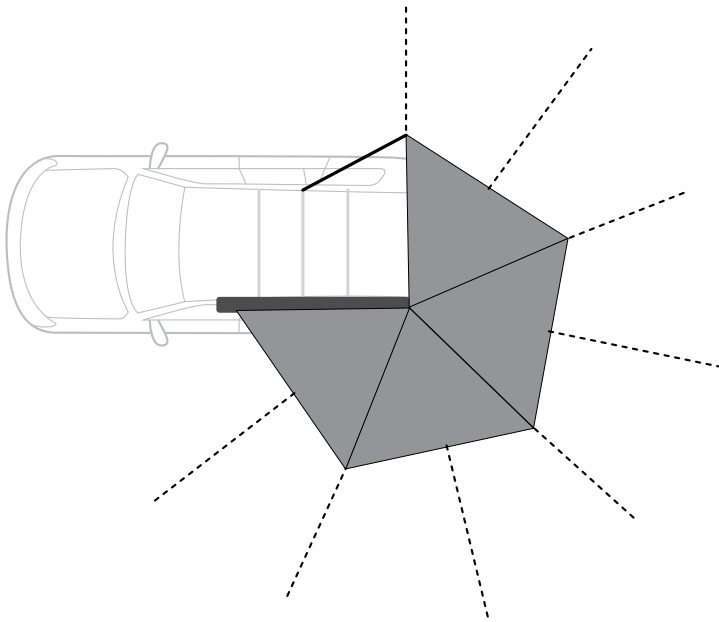
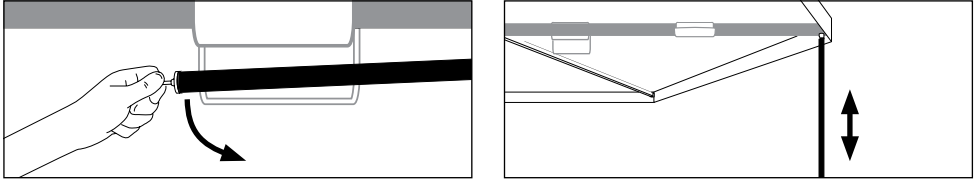

Undo the hook and loop fasteners that support each leg, taking care to support each leg as they pivot down to a vertical position. Adjust to the desired leg height by unlocking and locking the twist lock mechanism.

Secure each rafter by anchoring and tensioning the guy ropes.

Ensure all guy ropes are secured.

Tip: In case of rain, lower the legs to allow downward slope and guy off between the rafters to form valleys for water run-off.

AWNING PACK DOWN

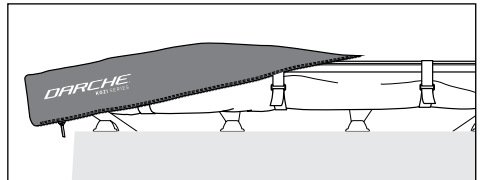
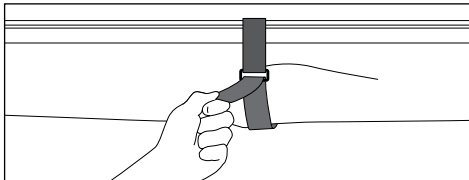
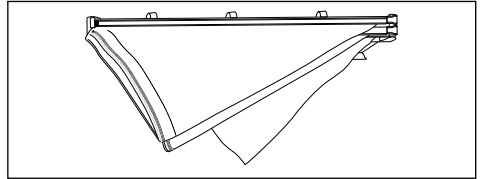
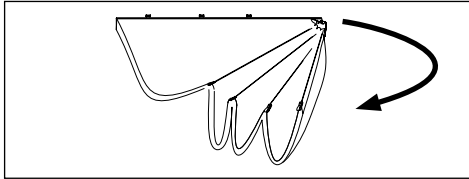

Step 1

Undo all pegs and roll up each of the guy ropes.

Step 2

Retract each of the legs, fold and stow away using the hook and loop fasteners.

Step 3

Release the rear tension strap.

Step 4

Retract the awning back, ensuring the top rafters are stacked on top of the bottom rafter poles. Canvas should drape down in a triangular shape.

Step 5

Roll and fold the canvas and secure using the hook and loop fasteners.

Step 6

Position the transit cover over the awning then zip up to complete pack down.

Tip: A loose roll is better than a tight roll. This will allow the canvas to fold flat against the awning making it easier to zip up the transit cover.

USING OPTIONAL AWNING WALLS

A 270 Awning Wall (sold separately) is available to use with this awning and can be installed by attaching the hook and loop fasteners on each of the wall sides plus and the top section of the wall to the awning. Join four walls to provide a sheltered area around the awning.

CARE INSTRUCTIONS

Clean with cold fresh water and a soft brush.

Do not use soaps or detergents on the awning.

Do not expose to petrol, oils or solvents.

Ensure awning is completely dry before storing.

STORING

Correct storage is vital for the longevity of your awning. If on occasion the awning is required to be stowed wet, it is essential it is unpacked and dried as soon as possible. Water damage, mildew damage and incorrect storage is not covered under warranty.

STRUCTURAL INTEGRITY

This awning has been designed for general camping in normal conditions. Always ensure all rafters are supported by leg poles and that all guy ropes are anchored correctly. It may be necessary to re-adjust guy ropes and pegs at times to maintain the structural integrity of the awning.

This awning is designed as a temporary shelter, not a permanent structure. Do not leave up for extended periods and do not leave unattended.

To avoid the chance of personal injury and or property damage, Darche recommends this awning should not be erected or used in extreme weather conditions.

WEATHER RESISTANCE

This awning is designed to resist water through careful selection of materials, use of water repellent coatings and seam sealing. Unfortunately, in very heavy weather conditions seams and zippers can still experience some leakage. You can purchase waterproofing products through outdoor camping retailers.

I N S T R U C T I O N M A N U A L

NOTES

NOTES

I N S T R U C T I O N M A N U A L

Designed and tested in Australia for Australian conditions.

A brand by Charles Parsons.

Telephone 1300 367 695 | Email: info@DARCHE.com.au

75 Heyington Avenue, Thomastown VIC 3074, Australia.

DARCHE: LEADERS IN OUTDOOR DESIGN. PROUDLY AUSTRALIAN.

Due to our policy of continual product development,
the specifications, colours and features may vary.

V1-May 2021



D A R C H E . C O M . A U