

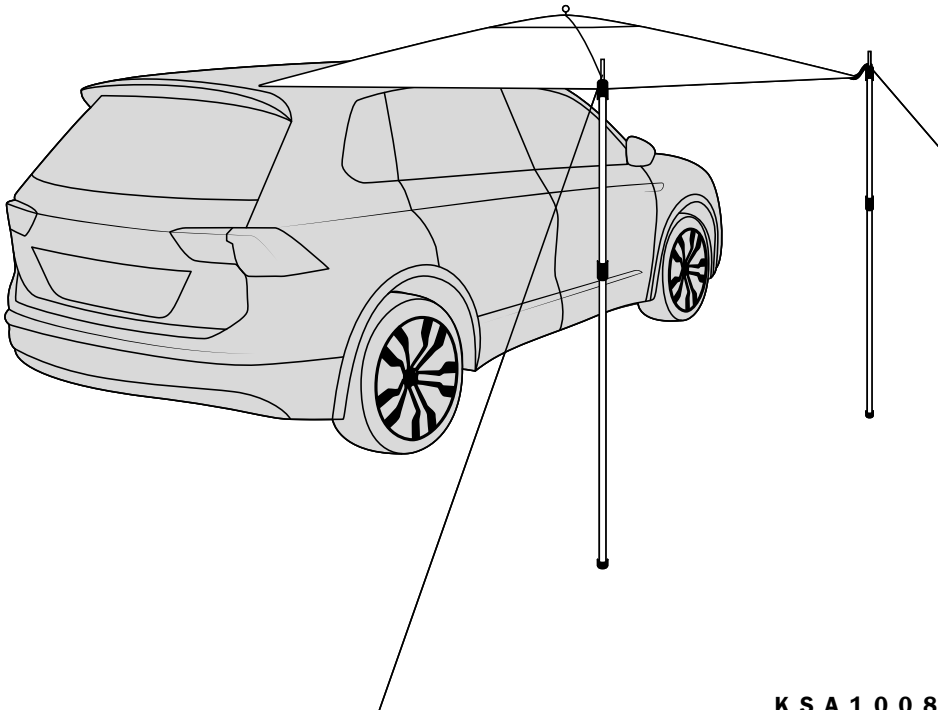

ALL-ROUNDER 1.8 M AWNING



INSTRUCTION MANUAL



KSA1008

INSTRUCTION MANUAL

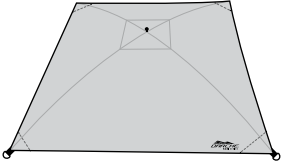
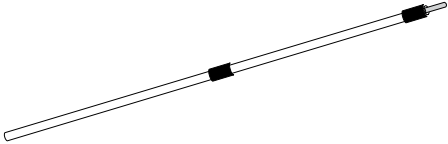
KOZI ALL-ROUNDER 1.8M AWNING - IDENTIFICATION CHART

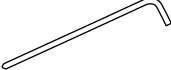
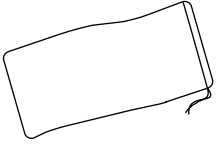
Awning	
Qty. 1	
Telescopic poles	
Qty. 2	
Suction cups	
Qty. 2	
Guy ropes	
Qty. 4	
Pegs	
Qty. 4	
Storage bag	
Qty. 1	

Before installing and using your awning please read the instructions and warnings below.

Should you have any questions or require assistance, please contact your Darche retailer or call our customer service line: 1300 367 695.

Familiarise yourself with the awning, we recommend that you unpack and set up this awning at home before use.

Incorrect set up or use is not covered under general warranty.

WARNING

Ensure sufficient awning fall for water run-off is provided.

Guy ropes can present trip hazards in day and night conditions.

Ensure all guy ropes are secured and anchored correctly.

Avoid using the awning in strong winds.

Keep all flame and heat sources including camp fires, BBQs, etc. away from the awning.

Under no circumstance should any naked flame sources or heating devices be used under or near the awning.

Keep a look out for any airborne burning embers that may come into contact with the awning.

DISCLAIMER

Please ensure the structure/surface to which the awning is attached is of sufficient strength. Darche is not responsible for any damage incurred through misuse.

FITTING GUIDE

Your Darche Kozi Series Awning has been designed for a universal fit with most makes and models of four wheel drives, SUVs, station wagons, utes and vans. When mounting the awning we suggest it is positioned to allow sufficient clearance for the vehicles doors to open.

INSTRUCTION MANUAL

SETTING UP YOUR AWNING.

STEP 1.

Place your awning upside down on the ground (black side up).

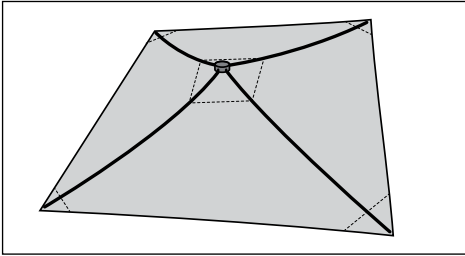

STEP 2.

Push down firmly on the centre of the awning to properly tension the awning.

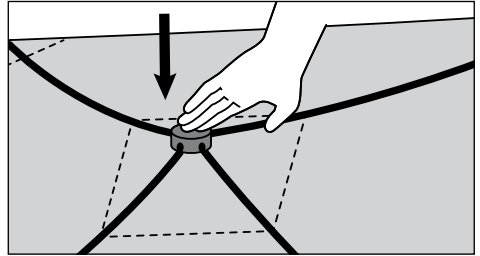

STEP 3.

To ensure a good bond and avoid scratching your vehicle, thoroughly clean then dry the areas on which the suction cups are to be placed (approximately 1.8M apart) with water and a clean cloth. Before each use ensure suction cups have also been wiped clean.

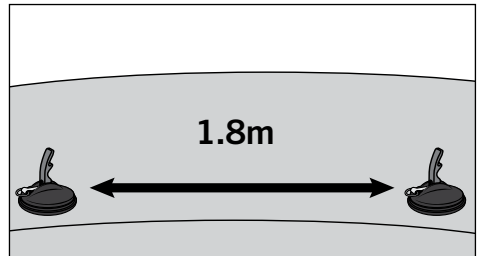
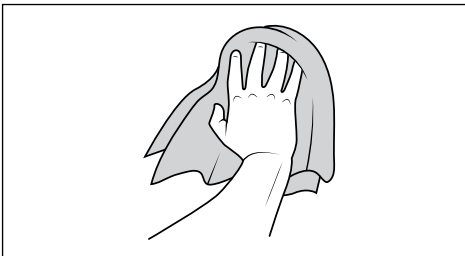

STEP 4.

Place the suction cups on the cleaned areas, then push the red lever down firmly to lock the suction cups in place.

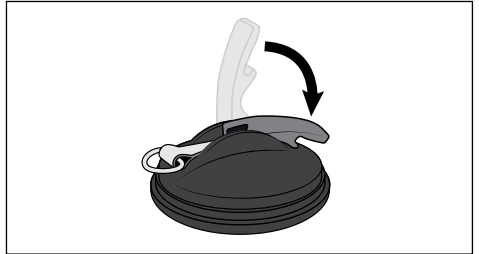
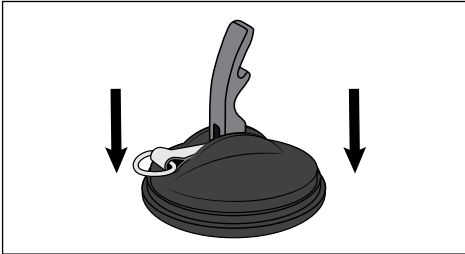

STEP 5.

Attach the awning to the suction cups with the clip, then adjust the strap lengths as necessary. See page 6 for more mounting options.

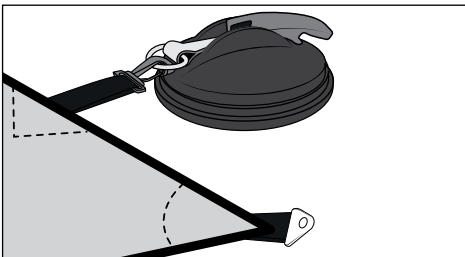

STEP 6.

Insert telescopic pole through eyelet, adjust the length of the pole to achieve sufficient headroom, then attach the guy ropes. Peg down then tension the guy ropes by adjusting the slider. Repeat on other corner.

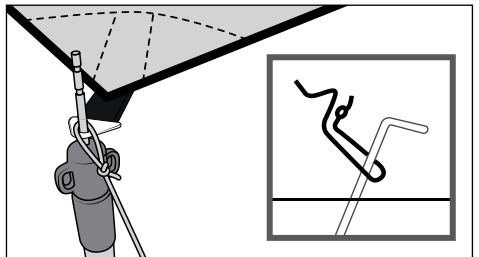

INSTRUCTION MANUAL

***Bonus:**

Your Kozi All-Rounder Awning can also be attached to almost any sturdy structure or even directly on the ground; your imagination is the limit.

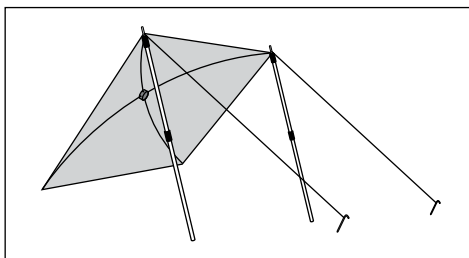
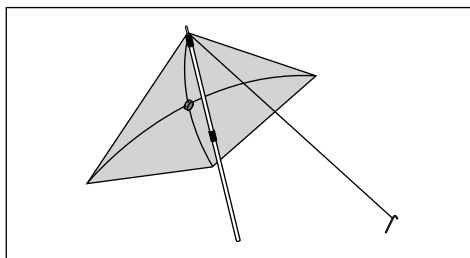
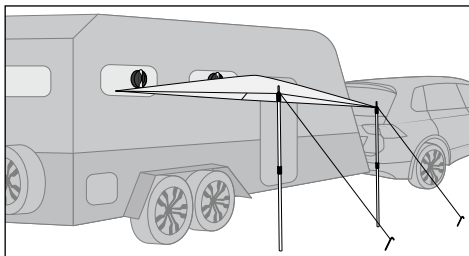
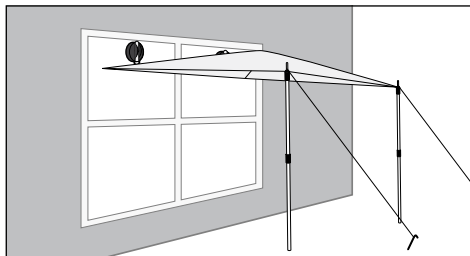

AWNING PACK DOWN

1. For awning pack down reverse the above steps.
2. Avoid packing up the awning when wet. If the awning must be packed away when wet, open it up to allow to dry completely at the earliest opportunity. Storing the awning wet for an extended period may result in mould or other issues.

CARE INSTRUCTIONS

Clean with cold fresh water and a soft brush.

Do not use soaps or detergents on the awning.

Do not expose to petrol, oils or solvents.

Ensure awning is completely dry before storing.

STORING

Ensure awning is completely dry before storing.

If the awning was packed away when wet, then it must be dried as soon as possible.

Incorrect storage is not covered by the warranty.

SUITABILITY

This awning has been designed for general camping in normal conditions.

It is not suitable for extreme weather conditions.

I N S T R U C T I O N M A N U A L

Designed and tested in Australia for Australian conditions.

A brand by Charles Parsons.

Telephone 1300 367 695 | Email: info@DARCHE.com.au

75 Heyington Avenue, Thomastown VIC 3074, Australia.

DARCHE: LEADERS IN OUTDOOR DESIGN. PROUDLY AUSTRALIAN.

Due to our policy of continual product development,
the specifications, colours and features may vary.

V2 - MAY 2022



D A R C H E . C O M . A U