



TORNADO INDUSTRIES, LLC
3101 WICHITA COURT
FORT WORTH, TX 76140
PHONE 800-VACUUMS
FAX 817-551-0719
WWW.TORNADOVAC.COM

**Operations & Maintenance Manual
For Commercial Use Only**



**BR 9/1 MULTIWASH
MODEL NO: 99409**

Form No. L9409 DA 06/20 ©Tornado Industries, LLC. All rights reserved

Save These Instructions

Your new Tornado unit is a high quality, precision-made product. All parts used in the manufacturing of this unit have passed rigid quality control standards prior to assembly. Please safeguard the original receipt / invoice. If you experience any problems with your unit during the warranty period, the original receipt / invoice will act as proof of purchase. Contact Tornado for any warranty inquiries.

IMPORTANT SAFETY INSTRUCTIONS

READ AND UNDERSTAND ALL INSTRUCTIONS BEFORE USING THIS UNIT

Read and understand this owner's manual and all labels on the unit before operating. Safety is a combination of common sense, staying alert and knowing how your unit works. Use this unit only as described in this manual. Use only manufacturer's recommended attachments. To reduce the risk of personal injury or damage to your unit use only Tornado recommended accessories.

Table of Contents	
Warranty	3
Important Safety Instructions	5
Electrical Connection	6
Guidelines for the Operator	7
Machine Parts	8
How it Works	9
Preparing for Use	9
Assembly	10
Controls	10
Operating the Machine	11
Cleaning the Machine	13
Maintenance	13
Transport Trolley	14
Side Brush	14
Technical Specification	15
Brush Selection Guide	15
Electrical Layout	16
Warranty Registration	17

NOTES

Within 30 days, to activate the warranty, go to;
<https://tornadovac.com/services/warranty-registration-form.aspx>

For warranty information go to www.tornadovac.com

**IMPORTANT SAFETY INSTRUCTIONS
FOR COMMERCIAL USE**

**WHEN USING AN ELECTRICAL APPLIANCE, BASIC PRECAUTIONS SHOULD
ALWAYS BE FOLLOWED INCLUDING THE FOLLOWING:**

READ ALL INSTRUCTIONS BEFORE USING THIS MACHINE

WARNING: TO REDUCE THE RISK OF FIRE, ELECTRIC SHOCK, OR INJURY:

Do not leave machine unattended when plugged in. Unplug from outlet when not in use and before changing pads or attempting any maintenance or adjustment. If handle switch lever is activated accidentally, high starting torque will cause machine to move and may cause damage or injury.

To avoid electrical shock, Use indoors only. Do not use outdoors and do not expose to rain. Do not allow to be used as a toy. Close attention is necessary when used by or near children.

Use only as described in this manual. Use only manufacturer's recommended attachments.

Do not use with damaged cord or plug. If machine is not working properly, if it was dropped, damaged, left outdoors, or dropped into water, return it to a service center.

Do not pull or carry by cord, use cord as a handle, close a door on cord, or pull cord around sharp edges or corners. Do not run machine over cord. Keep cord away from heated surfaces.

Do not unplug by pulling on cord. To unplug, grasp the plug not the cord.

Do not handle plug or machine with wet hands.

Keep hair, loose clothing, fingers, and all parts of body away from openings and moving parts.

Turn off all controls before unplugging.

Connect to a properly grounded outlet only. See Grounding Instructions.

Do not put hands under base - rotating parts could cause injury.

Always keep hands feet and loose fitting clothing away from moving parts to prevent possible injuries.

Use care to keep electrical supply cable from contacting moving parts, such as floor brushes or pads.

Risk of explosion: Floor sanding can result in explosive mixture of fine dust and air. Use this machine only in a well-ventilated area, free from any flame or match.

Do not use machine in areas where flammable and/or explosive vapors or dusts are present.

To avoid fires do not use with a flammable or combustible liquid to clean a floor.

Make sure voltage and frequency at the wall receptacle correspond with that indicated on nameplate before plugging in machine.

Use only a 12 Ga. three-wire extension cable, which have 3-prong grounding type plugs and 3-prong receptacles that accept the plug of the machine.

SAVE THESE INSTRUCTIONS

GROUNDING INSTRUCTIONS

This appliance must be grounded. If it should malfunction or breakdown, grounding provides a path of least resistance for electric current to reduce the risk electric shock. This machine is equipped with a cord having an equipment -grounding conductor and grounding plug. The plug must be inserted into an appropriate outlet that is properly installed and grounded in accordance with all local codes and ordinances.

WARNING: Improper connection of the equipment-grounding conductor can result in a risk of electric shock. Check with a qualified electrician or service person if you are in doubt as to whether the outlet is properly grounded. Do not modify the plug provided with the appliance - if it will not fit the outlet, have a proper outlet installed by a qualified electrician.

This appliance is for use on a nominal 115-volt circuit, and has a grounding plug that looks like the plug illustrated in sketch A.

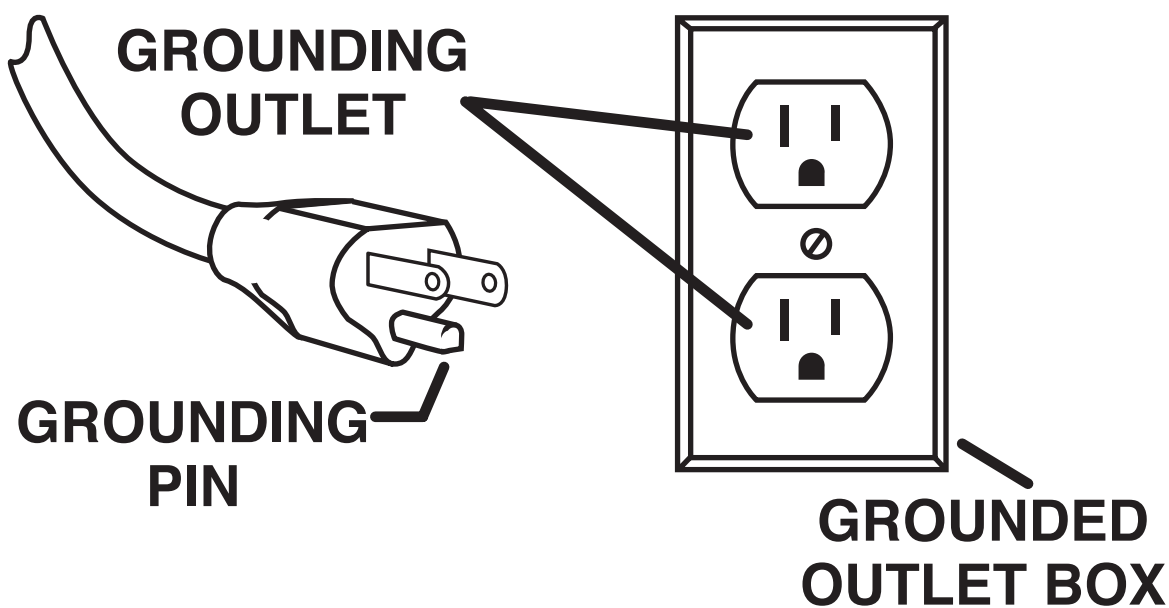

A

Introduction

This Tornado floor cleaning machine is designed to be used on smooth, even floors indoors. It can be used on most floor surfaces including carpet, wood, PVC, rubber and stone.

We are confident the machines will give years of trouble free service, coupled with ease of use and minimum maintenance.

The following instructions contain important information about the machine and safety advice for the operator.

To save space and to protect the machine during transit, it is supplied with its handle disassembled. Follow the simple assembly instructions.

Warning: The machine must be fully assembled in accordance with these instructions before connecting to the electric supply.

Important Safety Advice

When using electrical equipment, basic safety precautions should be followed:

- Read all instructions carefully before use.
- The machine must be unpacked and assembled in accordance to the instructions given.
- Keep children and unauthorized persons away from the machine when in use.
- Unplug the machine when not in use.
- Switch off the machine before removing the plug.
- When unplugging the cord, pull the plug and not the cord.
- Keep the power supply cord away from moving parts. Do not run the machine over the cord.
- Do not operate the machine with a damaged supply cord or plug, or after the machine malfunctions or is damaged in any way. Contact an authorized Service Center for repair or adjustment.
- When cleaning or performing maintenance to the machine, make sure that it is unplugged.
- Regularly inspect the power supply cord. If it is damaged, it needs to be replaced.
- Be careful when using the machine near the top of stairs.

Guidelines for the Operator

- Operators must be fully trained in the use of the machine in accordance with these instructions.
- Operators should be physically able to maneuver, transport and operate the machine.
- Operators should be able to recognize abnormalities in the machine.
- This machine should always be connected to a fully earthed power supply of the right voltage and frequency.
- Let the machine do the work. Grip the handle as lightly as possible.
- Wear suitable footwear to avoid slipping.
- Wear suitable clothing to keep dry and warm.
- Do not smoke when using the machine.
- Do not run the machine dry, as this could damage the floor surface or the machine.
- Do not use excessively foaming or highly corrosive cleaning solutions. If operating on a flooded floor, ensure that water depth does not exceed 6mm (1/4 inch).
- Do not operate the machine on rough surfaces, explosive atmospheres, slopes, near flammable liquids and where hazardous dusts are present.
- Only use brushes and accessories per the instruction manual. The use of other brushes and accessories may cause safety problems.

Warning! This machine is heavy. Do not attempt to lift the machine without assistance. Incorrect lifting techniques may result in personal injury.

Electrical Connection

Before connecting the machine to the power supply, check that your supply voltage corresponds with the rating label on the body of the machine.

Important: If the supply cord is damaged, it must only be replaced by a cord from the manufacturer or an authorized service agent.

Machine Parts

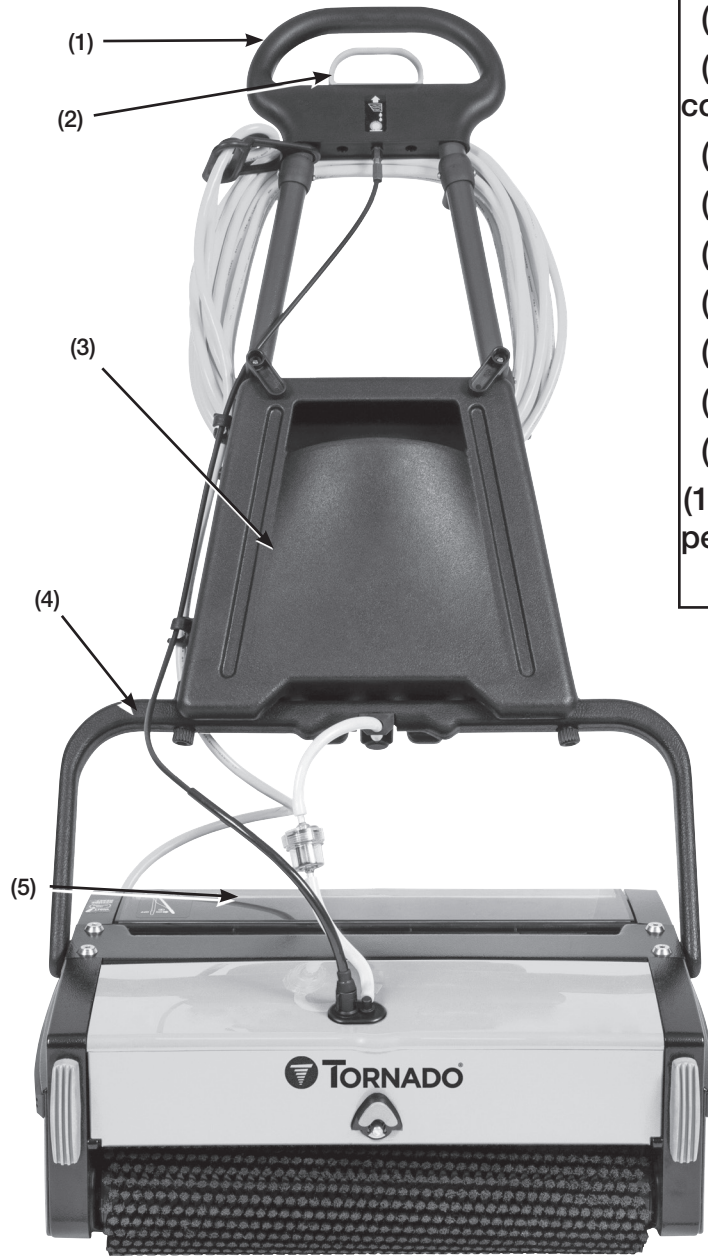

- (1) Top handle
- (2) Solution control handle
- (3) Solution tank
- (4) Bottom handle
- (5) Dirty water tank
- (6) Inline solution filter
- (7) Component housing
- (8) Conveyor drum
- (9) Brush
- (10) Handle release pedal

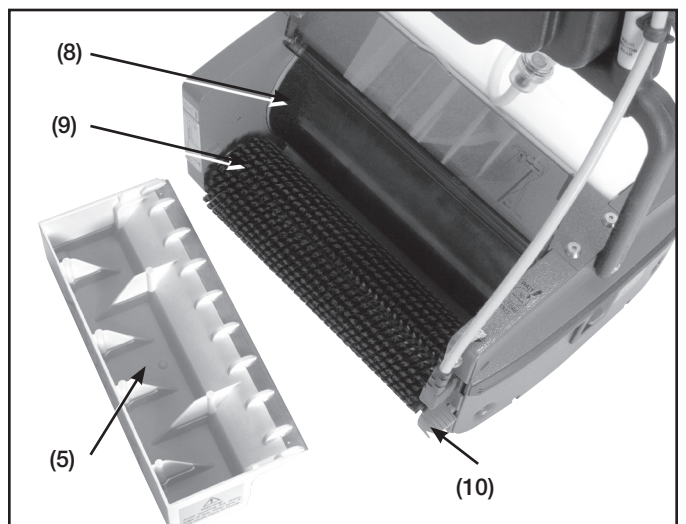
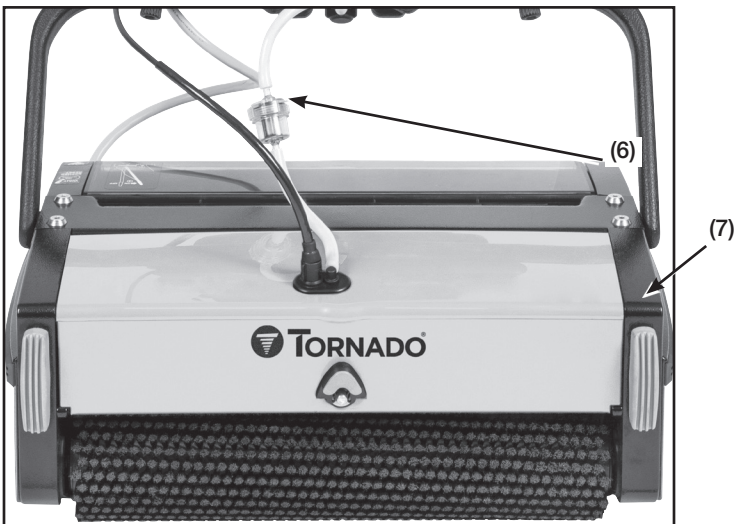

How it Works

How it Works

1. Cleaning liquid in the solution tank is sprayed to the floor.

The counter rotating brushes scrub the floor and also throw the dirty water on the conveyor drum. The front brush does most of the scrubbing and drying. The rear brush completes the scrubbing and collects the remaining water off the floor.

2. A blade fitted to the recovery tank wipes the drum and collects the dirty water.

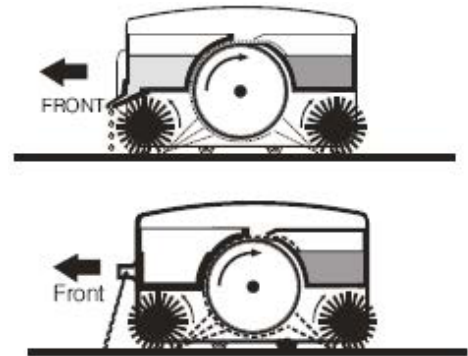

Preparing for Use

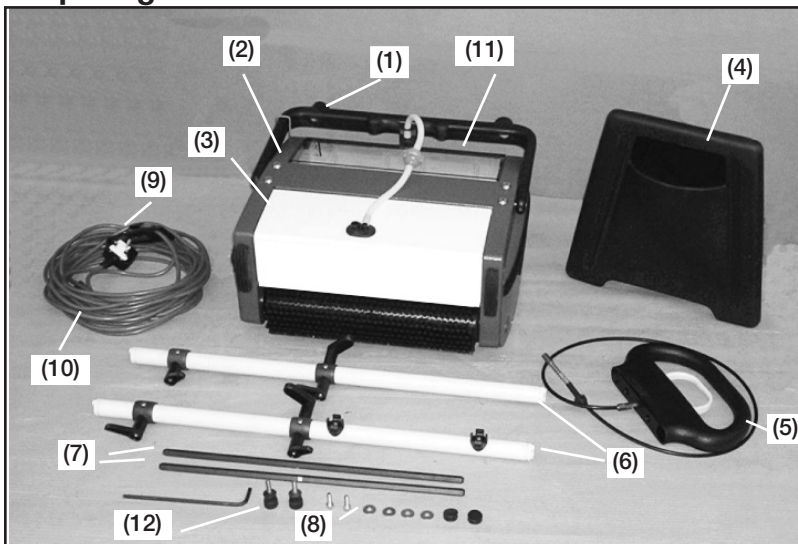

- (1) Bottom handle
- (2) Machine body
- (3) Component housing
- (4) Solution tank
- (5) Top handle and solution cable
- (6) Handle LH & RH
- (7) Brush shafts (2)
- (8) Screws & washers
- (9) Cable retainer
- (10) Power cord
- (11) Dirty water tank
- (12) Handle knobs

1. The Tornado BR 9/1 MW ships with the handle dismantled. To assemble, verify that all of the parts listed are included.
2. Remove the black band, which holds the bottom handle with the machine body, while holding the bottom handle.

Warning! Since the bottom handle is spring loaded, care must be taken when removing the hook to avoid sudden springing back, leading to possible injury to personnel.



The purpose of these caps is to distinguish between different brushes when the machine is used in different area. This just helps the operator easily identify the brushes to avoid cross contamination.

Important - Should the machine fail to operate, contact the supplier from whom you purchased the machine.

Assembly

1. Insert the two tubular handles into the bottom handle and secure them using the knob by tightening lightly. Make sure that the handles are assembled according to their marked position and the cable holding hooks are pointed towards the rear.
2. Slide the electric cable retainer into the top portion of RH handle.
3. Fit the top handle over the tubular handles and secure them with washer and screw (2 sets). Make sure that the label on the top handle is facing the front of the machine. Now firmly tighten both knobs and screws. Insert the plastic caps provided to cover the screws in the top handle.
4. Pass the free end of the pull cable through the plastic guide in the RH Handle. Press and twist clockwise to firmly secure the cable end to the lid pump housing.
5. Fix the solution tank firmly into the bottom handle by holding the top handle.
6. Rotate the knob to hold the solution tank.
7. The brushes are loosely packed in the machine for transit; therefore the brush shafts must be fitted before operating the machine. Push the shafts through the brushes from the side of the machine. To remove brushes, push the brush shaft out from the side of the machine using your fingers and pull it from the other side.
8. The machine is now ready for use.

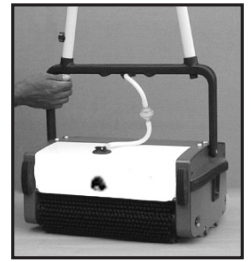

**RIGHT
BOTTOM
REAR**

**LEFT
BOTTOM
REAR**



Controls

Transport/Working Mode Control

Slide this knob to TOP position (Working Mode) to operate the machine. Slide this knob to BOTTOM position to move the machine and park the machine. The machine will not turn ON in this mode.

Warning! Keeping the knob in the top position (working mode) and moving the machine will damage the brushes.

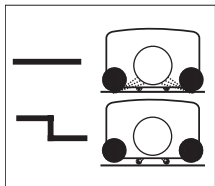

Transport mode



Working mode

On/Off Control

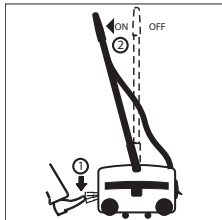

Release the pedal handle lightly with your foot (1), pull back the handle (2) to start the motor. The brushes and the drum starts rotating. Pulling the handle further without pressing the pedal, lowers the machine and engages the rotating brushes onto the floor. To stop working, take the handle to the vertical position.

Brush Contact Control

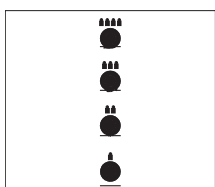

Brush contact with the floor is adjustable in 4 steps, contact is MINIMUM when the knob is fully down and MAXIMUM when it is fully raised. This helps you to compensate for the wear of brushes and also to control the scrubbing effect. If the machine does not move when the handle is lowered, slide the transport/working mode knob up one step.

Solution Control



By pulling the solution control handle up, the cleaning solution is dispensed on the floor. The solution stops once the solution control handle is released.

Pull Cable Connect / Disconnect Control

Insert the free end of solution cable into the valve body fitted in the solution tank. Press and twist clockwise to secure the cable end. Similarly, press and twist counter-clockwise to disconnect the cable end.

Motor Circuit Breaker

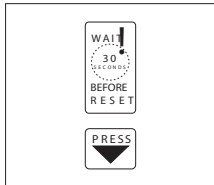

In the event of motor getting overloaded due to improper power supply or unexpected obstruction to the brush/drum rotation, the circuit breaker trips and protects the motor from damage. If this happens, identify the cause, correct it and, reset the breaker after minimum of 30 seconds from tripping by pressing the circuit breaker button manually and continue working.

Operating the Machine

Before the washing operation starts

Warning! Pre-sweep the floor to remove debris before using the Multiwash.

1. Verify that the brushes are fitted properly.
2. Fill fresh water tank with cleaning solution.
3. Insert the plug into grounded 3-pronged outlet.

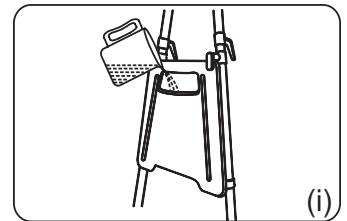

Recommended washing sequence

1. Start the machine by pressing the handle release pedal and pulling the handle back.

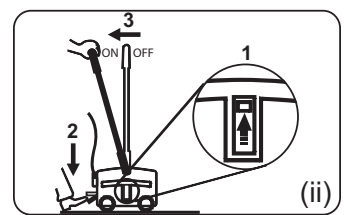

2. Move forward, while sparingly pulling the solution control handle (Fig-iii). This handle should only be pulled intermittently, based on the floor type and the amount of soil on the floor. For tiled or stone floors, apply very little water.

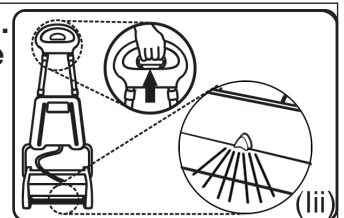

3. Stop the solution discharge approximately 12 inches before the end of forward motion. Continue to move forward up to the wall without pulling the pull handle.

4. Pull the machine backwards in the same track, but without discharging any solution. When you reach the starting point, change the track and repeat steps 2 through 4. When you are changing the track allow some overlap with the cleaned area. In case of large halls take a U-turn and move forward. If quick drying is required, move on the same track, without discharging any solution (Fig-iv).

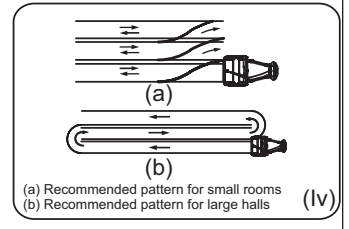

5. When you are finished with the cleaning operation, switch off the machine and unplug the power cord. Lift the recovery tank lid and remove the recovery tank. Empty the tank, rinse with clean water and clean off the steel wiper blade before replacing the tank on the machine.

IMPORTANT – Dispose of dirty water in accordance with all local, state and federal hazardous material disposal regulations.

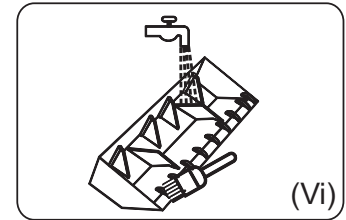
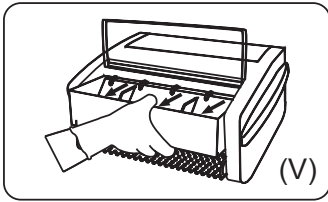

Warning! Avoid touching the sharp edge of dirty water tank. It may cause injury to hands.

Note. The spray pattern is adjusted by using the serrations in the spray nozzle and holder. Each serration allows a 4-degree change in the spray pattern.

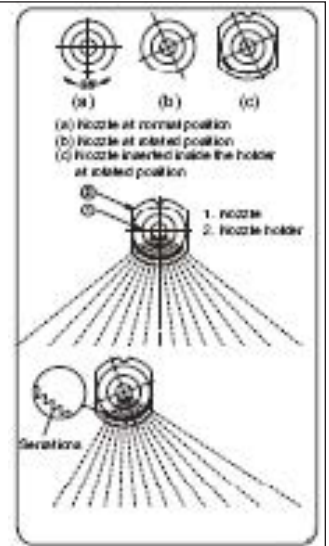

Cleaning the Machine



Warning! Switch off the machine and unplug from the electrical supply before performing any cleaning operations.

1. Move the Transport / Working mode control knob to **BOTTOM** (Transport) position to move the brushes off of the floor (Fig-viii).
2. Unplug the machine and wrap the supply cord around the hooks on the handle.
3. Pull out the dirty water tank and wash it completely.
4. To prevent possible clogging of the solution lines in the solution tank, empty any unused solution from the tank and filter, drain cleaning liquid, and keep the fresh water tank clean.
5. Remove the brushes by pushing the brush shaft out (Fig-ix).
6. Wash the brushes either by dipping in a bucket/sink or in running water (Fig-x).
7. Turn the machine on its side and wipe clean the rubberized drum and machine body with a damp cloth (Fig-xi).
8. Re-install the brushes after washing. It is easier to push the brush shaft from the right hand side (identified by the electrical cable).
9. Store the machine in a dry indoor area only.

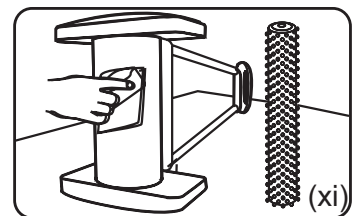
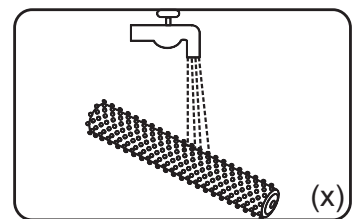
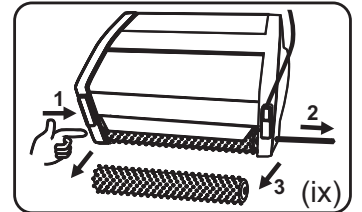
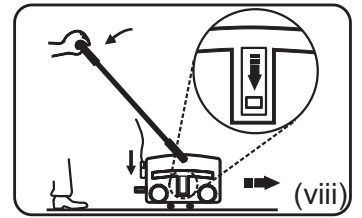

Maintenance



Warning! Before undertaking any maintenance operations or adjustments, switch off the machine and unplug from the electrical supply.

To get the maximum life of the machine, do the following:

- Supply Cord

Regularly inspect sheath, plug and cord anchorage for damage or loose connection. Replaced if damaged.

- Brushes

Wash the brushes regularly. Make sure that the machine is in Transport Mode when not in use. Store additional brushes in a vertical position to avoid bending the bristles. Check for permanent bending of bristles in a particular direction. This may occur if the machine is operated for several days without removing the brushes, which is not recommended. If this occurs, reverse the brush so that the bent bristles are straightened.

- Wiper Blade

If the wiper blade wears out, the water collection performance will decrease. It should be replaced by an authorized service agent.

- Solution Feed Filter (Pump)

The filter should be periodically cleaned. Use pressurized air/water for cleaning.

- Nozzle Maintenance (Pump)

If the spray nozzle is blocked, slide the nozzle cover off and remove the nozzle. Clean it with clean water and use a pin to unclog, then reinstall.

Accessories

Transport Trolley

The easily fitted trolley provides for ease of movement when transporting the machine.

 **Warning:** Empty all liquid from the machine before using the transport cart.



Using the transport cart

1. With the machine handle in the upright position place the cart in the middle alongside the machine.
2. By holding the machine firmly, tilt the handle away from your body. Slide the cart base under the machine and strap it to the machine with the velcro.
3. Ensure that the velcro strap is securely wrapped around the bottom handle.
4. Now the cart is ready to use. The machine can then be maneuvered easily while holding the top handle.

Brushes

Standard Brush	33982
Soft Brush	33981
Hard Brush	33983
Carpet Brush	33984
Side Brush	33990
Trolley	05-3395-0000

Brush Selection Guide

Type of floor	First time cleaning	Maintenance cleaning
Grouted Tile, Ceramic, Mosaic, Wood, Sports Floors, Rubber, Vinyl Tile	Standard	Soft
Short Pile Carpet	Carpet	Carpet
Marble, Granite, Slate	Soft	Soft
Smooth Concrete	Hard	Standard
Others	To suit individual floor conditions	

Technical Specifications

99409		BR 9/1 MW
Specification	U/M	
Voltage	V/Hz	115/60
Cleaning Width	in/mm	9/229
Body Height	in/mm	8.5/216
Handle Height	in/mm	44/1118
Width	in/mm	13/330
Length	in/mm	15/381
Weight	lb/kg	45/20.47
Motor Power	W/A	400/3.5
Brush Speed	rpm	650
Solution Tank	Gallon/Liter	.5/1.9
Cleaning Capacity*	sqft/hr/m ² /hr	2700/251
Noise Lever 69dB	db(A)	69

*Theoretical

Note:

1. Noise levels measured at a distance of 3.28 feet from machine and 5.25 feet above floor, when washing a hard floor. Measurements recorded using a hand held meter.
2. Handle vibration does not exceed 2.5 m/s², when operating on a smooth hard surface.

Electrical layout

Diagrams are made available in the cover (Power cord side) of the respective machine for service purpose.



Warning! Any service or attempt to service by persons other than authorized servicing agent will invalidate the warranty.

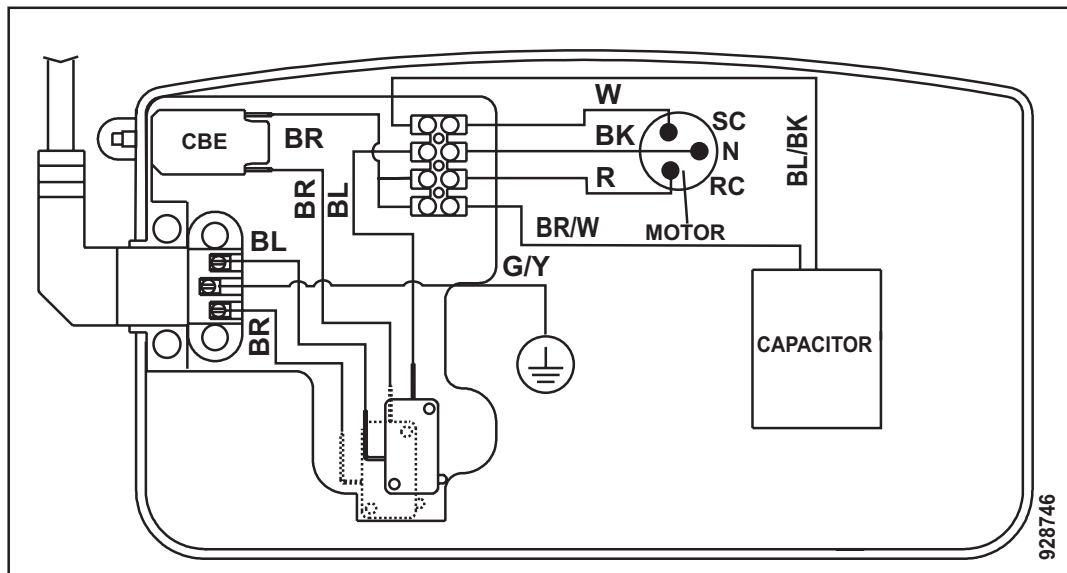



TORNADO®