



TORNADO INDUSTRIES, LLC
3101 WICHITA COURT
FORT WORTH, TX 76140
PHONE 800-VACUUMS
FAX 817-551-0719
WWW.TORNADOVAC.COM

Operations & Maintenance Manual
For Commercial Use Only



AUTOMATIC SCRUBBERS
Floorkeeper 28 TD/99128D
Floorkeeper 28 OB/99128OB
Floorkeeper 32 TD/99132D

Form No. L9128AA 08/19 ©Tornado Industries, LLC. All rights reserved

Save These Instructions



Long -Term Buyer Protection Limited Warranty

Tornado Industries, LLC. warrants to the end user/ customer that the Tornado product(s) will be free from defects in material and workmanship for the duration(s) described below. This limited warranty DOES NOT cover machines and/or components subject to normal wear and tear, damage that occurs in shipping, failures resulting from modification, accident, unsuitable operating environment, misuse, abuse, **neglect, or improper maintenance**. For full details, contact your Authorized Tornado Distributor, Service Center, or the Tornado Technical Service Department. Tornado sales and service representatives are not authorized to waive or alter the terms of this warranty, or to increase the obligations of Tornado under the warranty.

10 Years*

Plastic water tanks and Rotationally-molded bodies

2 Years*

Parts on all Tornado cleaning equipment

1 Year*

Labor on all Tornado cleaning equipment

1 Year*

Warranty on batteries, one year prorated

All battery warranties are handled directly by the battery manufacturer, on a one year prorated basis

Terms subject to change without notice

1. All Windshear™ Blowers, Storm, TV2SS, Side and Dowlndraft, Insulation Blowers, CV 30, CV 38, CK14/1 PRO, CK 14/1 BSE, CK14/2 PRO, SWM 31/9, CK LW13/1, CK LW 13/1 ROAM, CV 38/48 Dual, PV6, PV10, PV6 ROAM, Wall Mount Vacuum and all chargers are warranted for 1 (one) year for both parts and labor.
2. All non-wear item parts purchased after warranty expiration are warranted for 90 days.
3. Warranty starts from either: The date of sale to the consumer, or 6 months after the dealer purchased the unit from Tornado (at Tornado's discretion), whichever comes first.
4. The EB 30 is warranted for a period of 90 days for both parts and labor.
5. Propane-powered equipment engines are limited to the engine manufacturer's warranty.
6. Ride-on Scrubbers are warranted for 24 months parts, and 6 months labor, or 1,000 hours, whichever occurs first.

Note: Tornado, The Latest Dirt, Floorkeeper, Carpet-keeper, Carpetrinser, Carpetrinser/Dryer, Headmaster, Taskforce, PAC-VAC, T-Lite, Glazer, Windshear, Max-Vac and Trot-Mop are trademarks of Tornado Industries

Website: www.tornadovac.com

Phone 1-800-VACUUMS

Fax 817-551-0719

Address 3101 Wichita Court
Fort Worth, TX 76140

NOTES

Your new Tornado unit is a high quality, precision-made product. All parts used in the manufacturing of this unit have passed rigid quality control standards prior to assembly. Please safeguard the original receipt / invoice. If you experience any problems with your unit during the warranty period, the original receipt / invoice will act as proof of purchase. Contact Tornado for any warranty inquiries.

This operator's book has important information for the use and safe operation of this machine. Read this book carefully before starting the machine. Keep this book near the machine, protected from liquids and other substances that can cause damage to it. If you do not follow the instructions, you can cause an injury or damage equipment, furniture or buildings. Carefully inspect all components to ensure that there is no concealed freight damage. If such damage is discovered, file a "CONCEALED DAMAGE REPORT" immediately with the delivering carrier. The contents of this manual are based on the latest product information available at the time of publication. Tornado Industries LLC reserves the right to make changes or improvements without being obliged to apply changes to the machines previously sold.

IMPORTANT SAFETY INSTRUCTIONS

READ AND UNDERSTAND ALL INSTRUCTIONS BEFORE USING THIS UNIT

Read and understand this owner's manual and all labels on the unit before operating. Safety is a combination of common sense, staying alert and knowing how your unit works. Use this unit only as described in this manual. Use only manufacturer's recommended attachments. To reduce the risk of personal injury or damage to your unit use only Tornado recommended accessories.

GROUNDING INSTRUCTIONS

This appliance must be grounded. If it should malfunction or breakdown, grounding provides a path of least resistance for electric current to reduce the risk electric shock. This machine is equipped with a cord having an equipment -grounding conductor and grounding plug. The plug must be inserted into an appropriate outlet that is properly installed and grounded in accordance with all local codes and ordinances.

WARNING: Improper connection of the equipment-grounding conductor can result in a risk of electric shock. Check with a qualified electrician or service person if you are in doubt as to whether the outlet is properly grounded. Do not modify the plug provided with the appliance - if it will not fit the outlet, have a proper outlet installed by a qualified electrician.



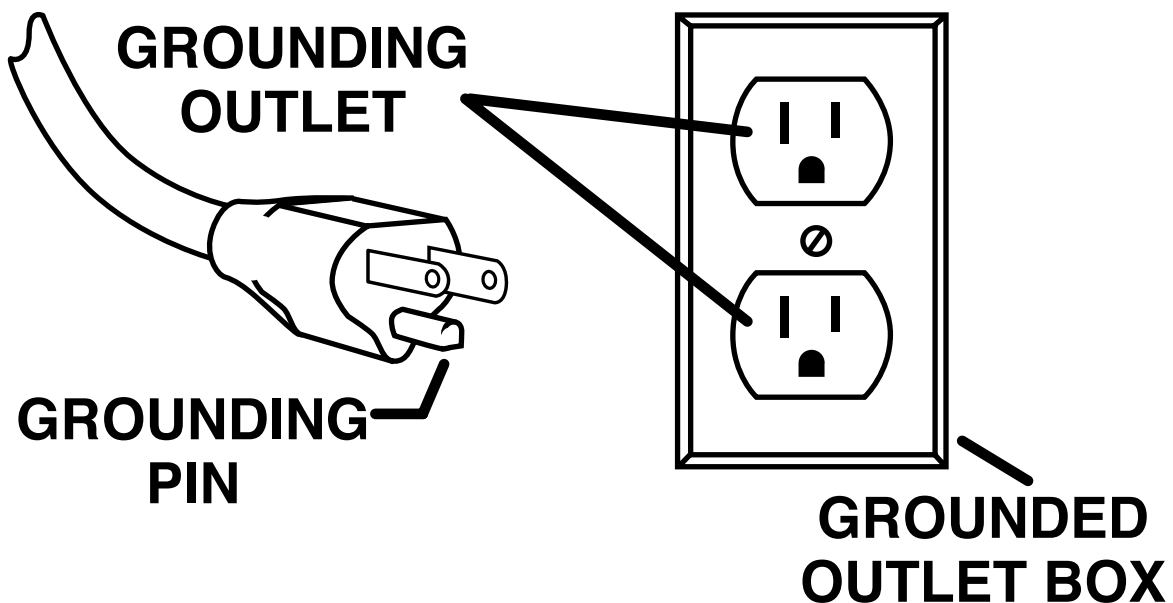





















This appliance is for use on a nominal 120-volt circuit, and has a grounding plug that looks like the plug illustrated in sketch A.

















SAFETY PRECAUTIONS

This machine is intended for commercial use. Only use recommended pads or brushes and commercially approved floor cleaning chemical intended for machine application.

The following symbols will be used to warn you of hazards or unsafe practices which could result in personal injury or death:

-  CAUTION: INDICATES A POTENTIALLY HAZARDOUS SITUATION WHICH, IF NOT AVOIDED, MAY RESULT IN MINOR OR MODERATE INJURY.
-  WARNING: INDICATES A POTENTIALLY HAZARDOUS SITUATION WHICH, IF NOT AVOIDED, COULD RESULT IN DEATH OR SERIOUS INJURY.
-  DANGER: INDICATES AN IMMINENTLY HAZARDOUS SITUATION WHICH, IF NOT AVOIDED, WILL RESULT IN DEATH OR SERIOUS INJURY.
-  WARNING: Fire or explosion hazard: Never use flammable liquids or operate machine in or near flammable liquids, vapors or combustible dusts. This machine is not equipped with explosion proof motors. The electric motors will spark upon start up and during operation which could cause a flash fire or explosion if machine is used in an area where flammable vapors/ liquids or combustible dusts are present.
-  WARNING: Do not pick up flammable or reactive materials.
-  WARNING: Batteries emit hydrogen gas. Keep sparks and open flame away. Keep battery compartment open when charging. Perform this procedure in a well ventilated area.
-  WARNING: Electrical hazard. Disconnect battery cables before servicing.
-  CAUTION: Spinning brush. Keep hands away. Turn off power before working on machine.
-  CAUTION: Do not operate machine unless trained and authorized.
-  NOTE: Do not operate machine unless operator manual is read and understood.
-  CAUTION: Do not operate machine if it is not in proper operating condition.
-  CAUTION: When using the machine, go slow on inclines and slippery surfaces.
-  CAUTION: When using the machine, wear non-slip shoes.
-  CAUTION: When using the machine, reduce speed when turning.
-  NOTE: When using the machine, report machine damage or faulty operation immediately to your supervisor.
-  CAUTION: When using the machine, never allow children to play on or around it.
-  CAUTION: When using the machine, follow mixing and handling instructions on chemical containers.
-  WARNING: When using the machine, do not use the machine as a means for transport.
NOTE: Do not allow the brush/pad to operate while the machine is stationary to avoid damage to the floor.
-  CAUTION: Do not bump into shelves or scaffoldings, especially where there is a risk of falling objects.
-  CAUTION: Before leaving or servicing a machine, stop it on a level surface.
-  NOTE: Before leaving or servicing a machine, turn off the unit and remove the key.
-  CAUTION: When servicing the machine, avoid moving parts. Do not wear loose jackets, shirts or sleeves
-  WARNING: When servicing the machine, do not wear jewelry when working near electrical components.
-  WARNING: When servicing the machine, disconnect battery connections before beginning work.
-  NOTE: Do not power spray or hose off the machine. Electrical malfunction may occur.

-  WARNING: When servicing the machine, do not work under the lifted machine without supporting it with safety stands.
-  NOTE: When servicing the machine, use manufacturer supplied or approved replacement parts.
-  NOTE: All repairs must be performed by a qualified service person.
-  CAUTION: When servicing the machine, do not modify the machine from its original design.
-  NOTE: When transporting the machine, turn the machine off.
-  CAUTION: When transporting the machine, do not lift the machine when batteries are installed.
-  CAUTION: When transporting the machine, get assistance when lifting the machine.
-  NOTE: Use a recommended ramp with a maximum of a 12° incline when loading or unloading into/off truck or trailer.
-  NOTE: When transporting the machine, use tie down straps to secure the machine to the truck or trailer.
-  NOTE: When transporting the machine, put the scrub head in the lowered position. Make sure the unit is off before doing so.
-  WARNING: Do not charge the batteries if the battery charger cable or plug is damaged.
-  WARNING: When charging batteries, do not smoke near the machine.
-  NOTE: When storing the machine, always store it indoors in an area where the temperature is between 32° and 104°F (0° and 40°C)
-  NOTE: Replace any and all safety labels located on the machine if they are missing or become damaged or illegible.

An optional item is a Hydralert™ battery water monitoring system. When the battery water falls below an acceptable level you will hear a audio alarm indicating the batteries need to be watered.

Scrubbers equipped with Hydralert™ technology have a sensor on the battery pack and an audio alarm which monitors and communicates low battery water conditions.

1. When batteries are fully charged and the key is turned on, Hydralert™ will check the water level

- If the audio alarm is not activated, there is sufficient water in the batteries
- An audio alarm means Hydralert™ senses a low battery water level.

NOTE: Failure to clean the Hydralert™ light pipe will limit Hydralert™'s ability to read the water level and will reduce battery life.

2. Turn the key off and the fill the batteries with distilled water. (See WET, LEAD ACID BATTERY MAINTENANCE)

NOTE: Battery packs equipped with Hydralert™ may take more than ½ gallon of water after the Hydralert™ audio alarm has been activated.

3. After completing the watering procedure, cycle the key to verify the audio alarm is not activated

CLEANING THE HYDRALERT™ SENSOR LIGHT PIPE



WARNING: Battery posts, terminals, and related accessories contain lead and lead compounds, chemicals known to the State of California to cause cancer and reproductive harm, and during charging, strong inorganic acid mists containing sulfuric acid are evolved, a chemical known to the State of California to cause cancer. Wash hands after handling. For more information go to www.P65Warnings.ca.gov

WARNING: Do not wear jewelry when working near electrical components

WARNING: Batteries emit hydrogen and oxygen gas

- Keep sparks and open flame away. Do not smoke near the machine

- Charge batteries in a well-ventilated area with the battery compartment open

CAUTION: Always wear protective clothing, gloves and goggles when handling and charging batteries

NOTE: Failure to clean the Hydralert™ light pipe will limit Hydralert™'s ability to read the water level and will reduce battery life

1. Remove the cap with the black sensor module being careful not to damage the yellow floats. Do not remove the black sensor module from the cap assembly.

2. Thoroughly wipe the clear light pipe next to the middle yellow float, paying extra attention to the tip of the pipe

3. While the cap is still removed, cycle the key and verify the audio alarm activates. Turn the key off

4. Carefully align the cap and press it firmly onto the battery making sure it is fully seated

5. Complete the battery servicing procedures above, cycle the key, and verify the audio alarm is not activated.

6. The machine is ready for use



MACHINE PREPARATION UNPACKING & BATTERY INSTALLATION

UNPACKING THE MACHINE

1. Remove the outer packaging.
2. The machine is fastened to the pallet with tie down brackets. Remove the brackets with a phillips tip in a cordless screwdriver.
3. Using a ramp, push the machine backwards down from the pallet.
4. Keep the pallet and brackets for any future transport needs.

Tie down bracket

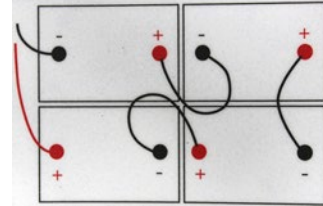

BATTERY INSTALLATION

The machine will be supplied with a battery charger and either two 12V wet or AGM batteries. The batteries must be housed in the battery compartment beneath the recovery tank.

To insert batteries:

1. Lift the recovery water tank, opening it as far as it will go using the side handle.
2. The batteries must be lowered into the compartment using lifting and transportation means suitable for the weight and dimensions.
3. They must be connected together in series, to obtain overall voltage of 24V on the lugs.



Recovery tank shown in fully open position

NOTE: Fully charge the batteries before using the machine.

BATTERY TYPE

To power the machine you can use either wet batteries or AGM batteries. Other types must not be used.

The maximum dimensions and the weight are:

Width:	7 1/8 in (181 mm)
Length:	10 3/8 in (264 mm)
Height:	11 5/8 in (295 mm)
Weight:	72 lb (37 kg)

NOTE: The on-board charger has been programmed to work with the batteries that Tornado provides. Using other battery types not specified for the units by Tornado may impair performance of the unit and will affect the life of the batteries.

NOTE: Your charger must be set according to the type of battery you install. Read charging section of manual for further instructions on how to set your charger correctly for your battery type.

MACHINE PREPARATION

BATTERY POWER LEVEL INDICATORS

The battery power level gage is located on the upper control panel. The gage has a series of LEDs to indicate the amount of power left in the batteries. When the batteries have a full charge, all LEDs are lit. As the batteries are discharged, the LEDs will begin to go out from right to left. To maximize the life of the batteries, do not allow the LEDs to go beyond the discharge level as described below.

To maximize the life of the batteries, only recharge the batteries when the machine is operated for a total of 30 minutes or more and always recharge the batteries immediately after usage when LEDs are indicating charging is required as described below.

BATTERY POWER LEVEL INDICATOR

The battery power level gauge is located on the upper control panel. The gauge has red, yellow and green LEDs to indicate the amount of power left in the batteries.

On lead acid battery-equipped units, when the discharge level reaches the first red LED, it is a good time to finish your scrubbing application and recharge the unit. If you do choose to continue scrubbing, when the last red LED begins to flash, the unit will shut down the brush motor but leave the vacuum and traction drive operational to perform final water recovery and transport back to storage. This function not only serves as an indicator that your battery level has reached a point where recharging is required, but also protects the batteries from being fully discharged.

AGM battery-equipped units should not be used after the last yellow LED goes out leaving only red LEDs. Using the unit beyond this point can reduce the life of the batteries.

NOTE: The traction drive battery power level gage also displays fault codes. The LEDs will flash specific fault codes if a fault is detected. See Troubleshooting section for LED fault codes.

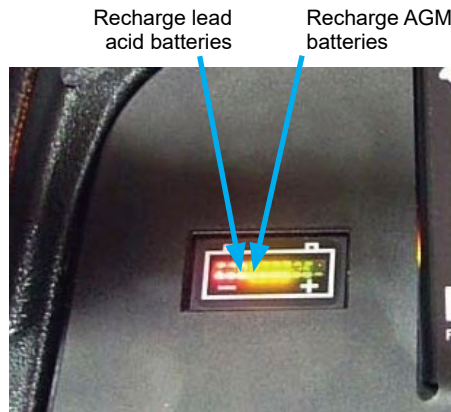

Battery Level Indicator -
Traction Drive Models

MACHINE PREPARATION

USING YOUR ON-BOARD CHARGER

CHARGING THE BATTERIES WITH AN ON-BOARD CHARGER

Before using your unit for the first time, fully charge your batteries.

1. These units are equipped with an on-board charger.
2. The on-board charger is equipped with a 9 foot long cord that can be plugged directly into a 120V outlet.
3. The cord wrap on the unit has a quick-release hook. The lower hook allows the user to slip the cord off and then the cord can be lifted off the upper hook, all without having to unravel the entire cord.



On-board charger



On-board charger cord wrap



Quick release hook

The on-board charger has charging indication LEDs - the red LED means it has just started the charging cycle, the yellow LED indicates that it has reached the second phase of charging and green LED means the unit is fully charged.



- ← Green indicates charge cycle is complete
- ← Yellow indicates charge cycle is in the second phase
- ← Red indicates charge cycle has just begun

Charging indication LEDs

After charging is complete, wrap the cord of your on-board charger securely to ensure the cord is not damaged.

MACHINE PREPARATION

SETTING THE DIP SWITCHES ON YOUR ON-BOARD CHARGER FOR YOUR BATTERY TYPE

The on-board charger is able to charge wet, lead acid or maintenance-free AGM batteries. As your unit leaves the factory, the charger is set up to match the type of battery chosen in the original machine order. Should you choose to change from the original battery type, the charger can be changed by re-setting the dip switches.

NOTE: The on-board charger has been programmed to work with the batteries that Tornado provides. Using other battery types not specified for the unit by Tornado may impair performance of the unit and will affect the life of the batteries.

To access the dip switches, use a small screw driver to lift the corner of the label on the on-board charger and peel back partially to reveal them. Set the dip switches as shown below for the specific battery type being used in your machine.



Use small screw driver to lift label off charger

	BATTERY TYPE	NA104 TROJAN 260AH LEAD ACID
	DIP SWITCHES	Off (L)
		OFF (L)
		OFF (L)
ON (R)		

	BATTERY TYPE	NA105 FULL RIVER 250AH AGM
	DIP SWITCHES	Off (L)
		OFF (L)
		OFF (L)
OFF (L)		

MACHINE PREPARATION

SOLUTION TANK

To prepare the machine for cleaning, the unit must be filled with cleaning solution.

1. Water and cleaning detergent can be added to the unit's rear hose fill port located to the left of the control panel.

2. There is also a front fill port that is able to accept hose or bucket filling.

Liquid detergent should be added to the tank in the concentration and manner specified by the manufacturer for an eleven (11) gallon solution tank. The formation of excess foam could damage the vacuum motor, so be sure to use only the correct amount of detergent. Water temperature should not exceed 120°F (50°C).

1. It is easy to gauge the solution level by watching the fog-free solution sight gauge at the rear of the machine. Additionally, marks on the tank provide solution level indicators as a guide.

2. The bottom of the front fill port is also a full level indicator. Once you are able to see water at the base of the opening, you have reached the full level.

3. The sight gage hose performs double-duty as the solution drain hose as well. You simply slide the hose off the press fitting and lower the hose to a drain or mop sink.



Rear hose fill port



Front fill port

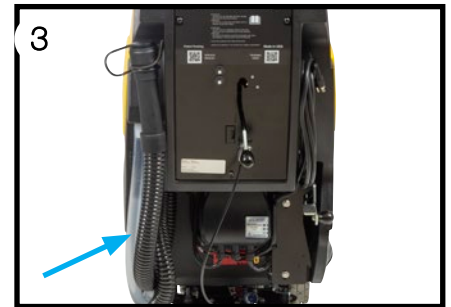

Sight gage hose

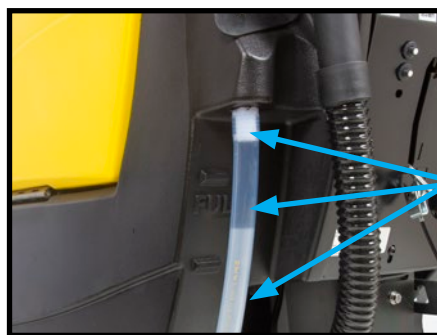

Sight gage hose released from press fitting

MACHINE PREPARATION

ATTACHING A CLEANING PAD TO YOUR PAD DRIVER - DISK HEAD

If using a floor pad with your pad driver:

1. Place your pad drivers on a work surface and remove the center lock fitting from the pad driver. To do so, squeeze the center lock wires inward and lift the center lock off the pads.
2. Connect the cleaning pad to the disk pad drivers by centering them on the drivers.
3. Squeeze center lock wires inward and press center lock down, tab side first, compressing the pad and then release the wires so that they lock in place holding the pad. Repeat for the other pad driver.

NOTE: The pad drivers are tufted pad drivers. Do not use a pad driver on the floor without a pad in place. This will cause damage to your floor.

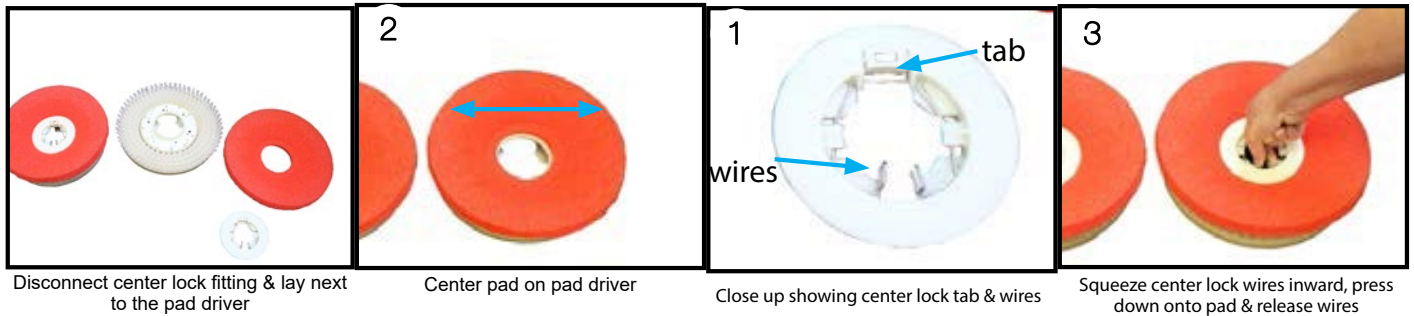

MACHINE PREPARATION

ATTACHING YOUR PAD DRIVER OR BRUSH TO THE SCRUBBER - DISK HEAD

The pad drivers or brushes are attached by using the automatic on/off system. This valuable ingenuity removes the need for operators to kneel or strain to attach the pad driver or brush. First, start by placing the pad driver or brush on the floor in front of the scrubber.

1. Turn the unit on using the power key switch.
2. Push or drive it into position so that the unit's scrub head is centered over the pad driver(s) or brush(es).
3. Utilize the foot pedal to lower the scrub deck down onto the pad driver or brush by depressing the pedal while shifting it to the right. Once clear of the lower notch, lifting your foot will lower the scrub deck. Make sure that the shroud completely covers the pad driver(s) or brush(es) in the lowered position. Should the shroud be resting on a portion of the pad driver or brush, the head isn't centered and will not attach properly.
4. The operation is completed by quickly pulsing the activation trigger. This will "click on" the pad driver(s) or brush(es). If the pad driver(s) or brush(es) do not quickly engage, do not continue pressing the activation trigger. Realign the scrub deck and try the procedure again. When you have the scrub deck aligned properly, you should see a noticeable drop of the scrub deck when lowered and the bristle skirt on the shroud should almost be touching the floor.

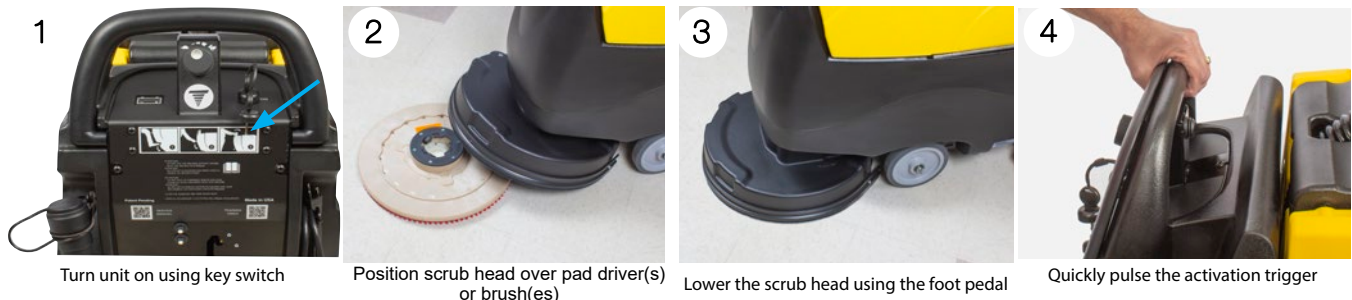

MACHINE PREPARATION

ATTACHING YOUR PAD - ORBITAL HEAD

ATTACHING A PAD TO YOUR ORBITAL PAD DRIVER

The orbital unit can be used for daily cleaning; however it specializes in chemical-free finish removal for low-cost finish maintenance programs. The following directions show how to prepare the machine for both applications.

For cleaning, the orbital unit is fit with a rectangular, 20 in (508 mm) x 14 in (356 mm) pad. The head comes standard with a rectangular pad drive plate with a Mighty-Lok® connection system.

1. To attach the pad, align the front corners of the pad to the front corners of the orbital drive plate and press to attach.
2. Use the foot pedal to lower the scrub deck down onto the pad ensuring alignment from front-to-back and side-to-side.
3. When the head is properly set onto the pad, you are ready for cleaning.



Align the front corners of the pad and press to adhere

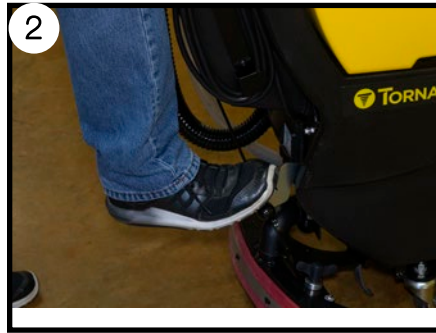

Lower the scrub head using the foot pedal

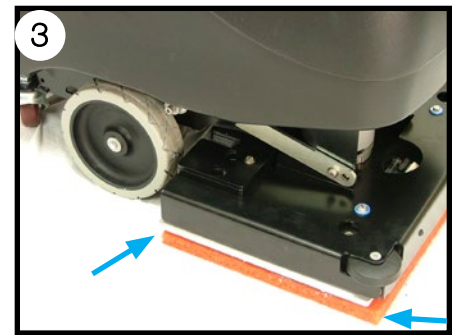

Proper alignment of pad

For chemical-free finish removal, it requires the addition of a specialized surface preparation pad. The application still requires the attachment of a traditional cleaning pad first. This pad acts as a "backer pad" which compensates for low and high spots in the floor.

1. Align the Velcro pad retainer along one length of the red, backer pad and press down. This will leave a 2" gap along one side of the backer pad. Then place the surface prep pad on top of the pad retainer, centering it from front-to-back & side-to-side with the red pad. **The 2" gap left by the pad retainer needs to be at the front of the machine so that water can fully saturate the pad.** Align your pad assembly with all corners of the pad driver and press upward. The red backer pad should be in closest contact with the pad driver.

2. Finish the operation by using the foot pedal to lower the scrub deck down onto the surface preparation pad, once again ensuring alignment from front-to-back and side-to-side. When the head is properly set onto the pad, you are ready for your finish maintenance program.

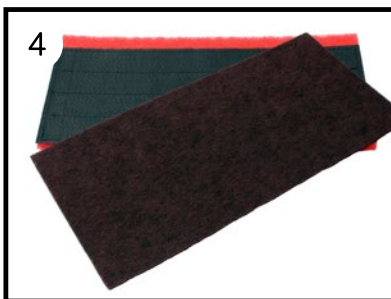

Red backer pad & Velcro pad retainer (black) alignment shown above with surface prep pad (brown) pulled away

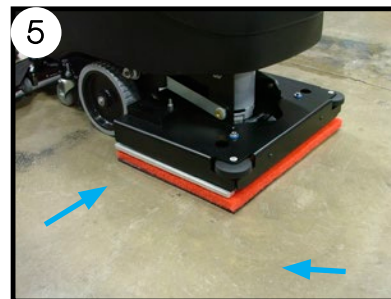

Proper alignment of pad

MACHINE PREPARATION

CONNECTING THE SQUEEGEE AND ADJUSTING WHEEL HEIGHT

Prior to shipping from the factory, the squeegee assembly is removed from the unit. To connect your squeegee assembly to the machine:

1. Align the squeegee assembly retention slots with the easy-grip knobs then tighten until secure.
2. Attach the recovery hose to the squeegee assembly neck. Make sure to route the loop hose trap between the squeegee assembly neck and left easy-grip knob.

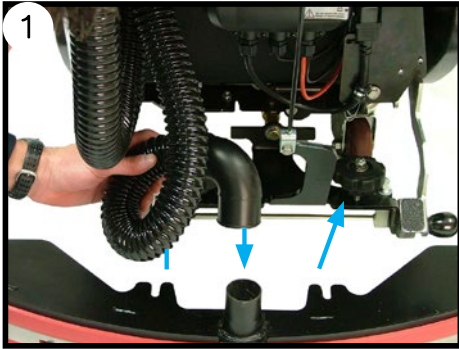

Positioning the squeegee assembly to mount onto the squeegee frame

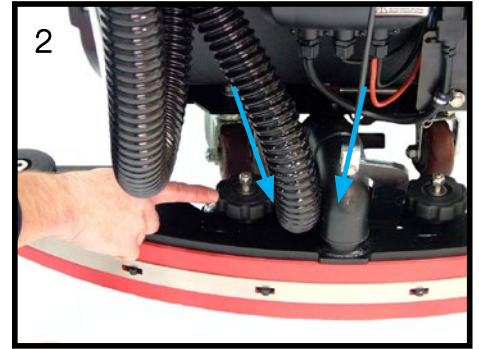

After aligning assembly, tighten the easy-grip knobs and attach the recovery hose.
**Arrows indicate proper hose routing*

1. The squeegee blade assembly height is factory set at the optimum water recovery position with the squeegee wheels being approximately 1/32 inch (1 mm) off the ground allowing the recovery blade to deflect as shown below.

2. If for some reason your squeegee blade height must be adjusted, it is done so by turning the left thumb screw located on the squeegee frame assembly clockwise to raise the left squeegee wheel and counter-clockwise to lower the wheel. The same is true for the right thumb screw/squeegee wheel.

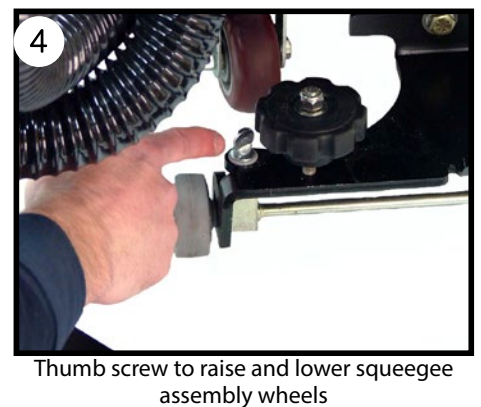
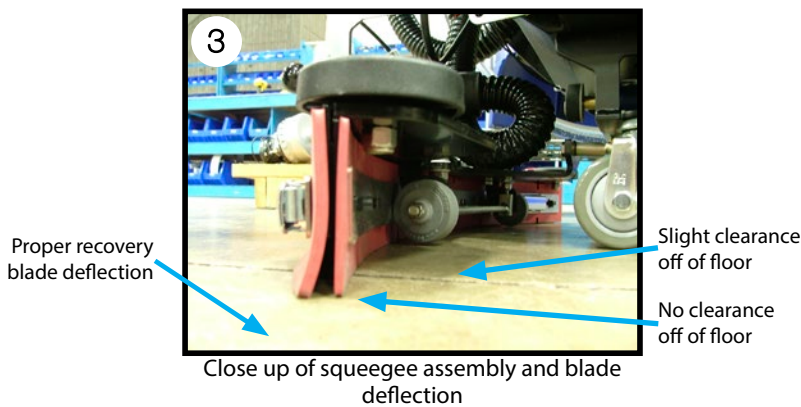

MACHINE PREPARATION

RECOVERY TANK PREPARATION & PLASTIC BAG HOLDER

TREATING YOUR RECOVERY TANK

Your scrubber has been designed with a debris tray. The unit also utilizes Bromine tablets, typically used in pools and spas, to kill the bacteria in the tank that cause odors.

1. Lift the recovery tank lid to the open position and locate the debris tray.
2. Lift the debris tray out and turn it over so that you are able to pinch the two tabs protruding from the underside of the debris tray together to release the Bromine tablet holder.
3. Check the size of the Bromine tablet. Replace the Bromine tablet when it is approximately 25% of its original size.
4. Press the bromine tablet back into the debris tray.

⚠ CAUTION: Use Bromine only! Do not use chlorine. Chlorine can interact with ammonia based detergents to cause harmful fumes.



The Bromine tablet holder is located in the debris tray inside the recovery tank

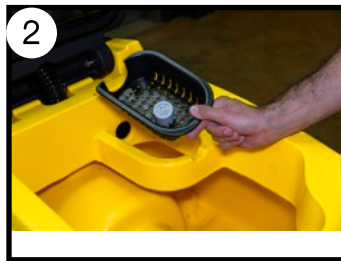

Remove the debris tray

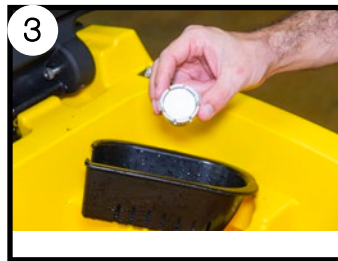

Check the bromine tablet

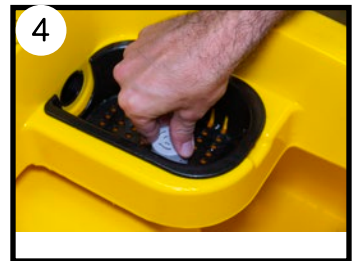

Press the bromine tablet back into the debris tray

PICKING UP LARGER DEBRIS DURING THE CLEANING PROCESS

Your scrubber has been designed with two hooks molded into the handle that can be used to hang a plastic bag to put larger pieces of debris that you come across during the cleaning process or that obstruct the squeegee assembly and cause streaking. Simply slide a handle of the plastic bag over each of the hooks.

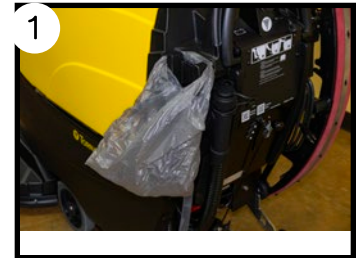

Plastic bag hooks indicated above

MACHINE OPERATION

OPERATIONAL CONTROLS

TURNING THE UNIT ON/OFF

The machine is powered on through a key switch on the upper control panel. Turn the key to the ON position. You will see the battery meter on the left side of the upper control panel light up to show the battery charge level.

The key switch is a proven way to eliminate unwanted operation. Simply remove the key and safely store it away when you have completed scrubbing.



Key switch shown above

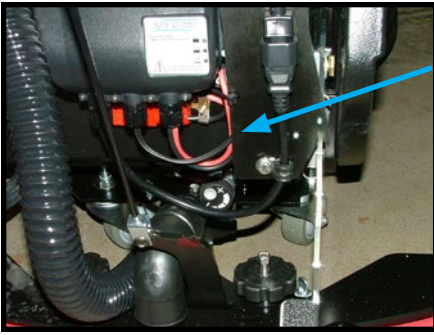

Solution flow adjustment knob

SETTING DESIRED SOLUTION FLOW RATE

The next step is to set the unit to the desired solution flow. This control feature is located at the lower rear of the machine and can be adjusted from low to high flow spanning a range of 0 to 0.5 gallons (1.9 L) per minute.

Once the machine is powered on and the solution flow is set, it takes three simple steps to operate the machine: lower the scrub deck, lower the squeegee and engage the activation trigger. These steps are visually shown on the lower control panel of the unit's "1, 2, 3-Step" on-board operation guide. Following are the detail steps of how scrubbing and recovery functions are activated.



On-board "1, 2, 3-Step" operation guide

LOWERING THE SCRUB DECK

The scrub deck is lowered using the foot pedal at the rear of the unit.

1. Place your foot on the pedal and depress the lever while shifting it to the right. Once clear of the lower notch, lifting your foot will lower the scrub deck into the operating position.

2. The scrubbers have 3 down pressure settings

- The 28" and 32" disk units have settings of 70, 110, and 150 lbs. (32, 50, and 65 kg)
- The 28" orbital unit has settings of 70, 110, and 160 lbs. (32, 50, and 73 kg)

When the unit is set into operating position with the foot pedal, it is in the lower down pressure position. This position is typically used for daily cleaning of normal soils. However, should you have tough soils or want to perform chemical-free finish removal, you can engage the higher down pressure settings. To engage the medium down pressure setting, lift the foot pedal lever so that the hook is secured in the cutout in the foot lever. To engage high down pressure, lift the foot lever to the upper notch position so that the bottom of the lever is locked on the hook of the bracket. To disengage medium or high down pressure simply lift and shift the lever to the right and lower it into the normal operating position.

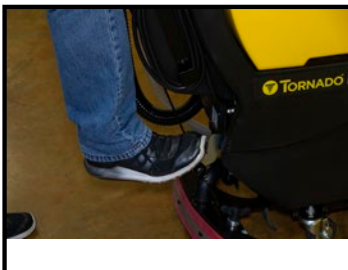

Lowering scrub head using foot pedal



Low down pressure setting

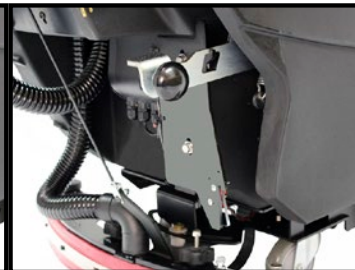

Locking in medium down pressure setting by lifting foot lever



Locking in high down pressure setting by lifting foot lever

3. The disk scrub head is equipped with a self-adjusting shroud with bristle skirt that virtually eliminates overspray and increases the ease of use.



Self-adjusting head shroud with bristle skirt

LOWERING THE SQUEEGEE

To lower the squeegee, lift the squeegee lever and shift it left to clear the notch. Once clear, lower the squeegee into the recovery position. In doing so, the unit's vacuum motor will activate.

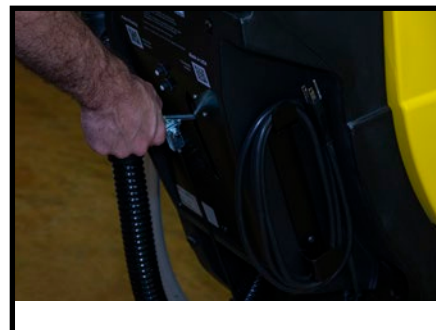

Lowering the squeegee assembly

ACTIVATING THE SCRUBBER

1. To begin scrubbing, engage the handle trigger. The trigger activates solution flow, the brush motor and traction drive, if equipped. This unique, ergonomic design accommodates different operator heights by allowing the user to activate the trigger from any position on the handle.

2. The speed control and reverse switch on the traction drive models are purposely located so that the operator doesn't have to let go of the machine with either hand to perform the function. Speed control is easily thumb adjusted and the reverse can be depressed with your fingers on the back side of the control housing.

3. This one-handed reverse feature allows the operator to lift the squeegee with the other hand – a small element with big rewards when in tight spaces.



Activating the handle trigger



Speed control adjustment

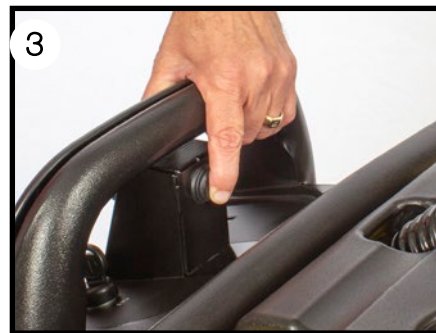

Reverse switch is easily reached with fingertip

TRANSPORT MODE

The scrub deck and squeegee must be in the raised position for transport.

1. The scrub deck is raised into transport position by placing your foot on the foot pad and depressing the lever until it clears the lower notch. Once clear, shift the lever to the left and place it into the lower notch.

2. To raise the squeegee, lift the squeegee lever high enough to clear the notch, shift it to the right and lower it into the resting position. The vacuum will continue to run for 10 seconds in order to evacuate the recovery hose.

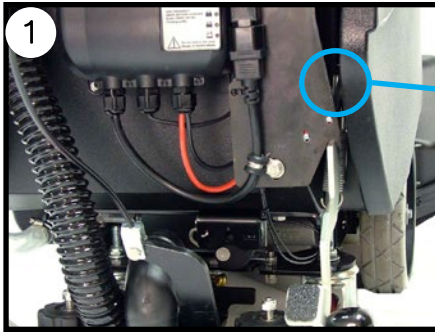

Scrub deck in transport/storage position

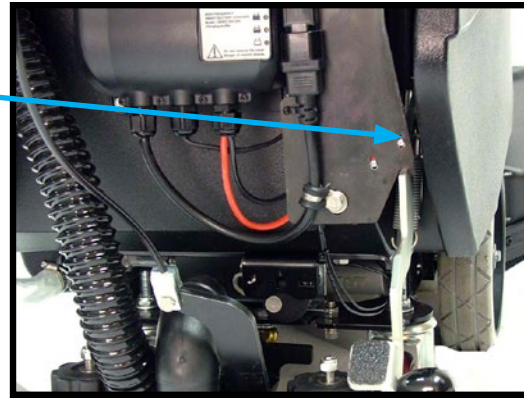

Squeegee assembly in raised/storage position

1. Easily transport machines in, out or through facilities with the scrubber's unique squeegee hanger feature. Simply remove the squeegee assembly (see Page 14) while leaving the recovery hose attached, lift the squeegee to a vertical position on the right side of the machine and place the squeegee tab into the squeegee hanger.



Squeegee hanger tab



Squeegee hanger recess on scrubber

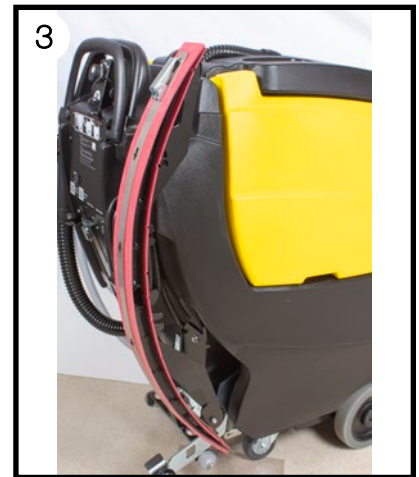

Squeegee assembly in transport position

MAINTENANCE

SCHEDULE FOR SERVICE

MAINTENANCE	DAILY	WEEKLY	MONTHLY	EVERY SIX MONTHS	100 HOURS	200 HOURS
Clean squeegee assembly. Check blades for wear or damage. Check if adjustment needed to squeegee height	X					
Clean out recovery tank inside and out and float shut off assembly. Check both for damage. Leave recovery tank open during storage	X					
Empty and clean out debris tray in the recovery tank	X					
Empty any debris from front fill port strainer	X					
Clean pad / brush and check for wear or chemical build up	X					
Check handles, knobs and switches for damage	X					
Charge batteries (if machine used longer than 30 minutes)	X					
Check hoses for wear, blockages or damage	X					
Clean outside of solution tank and clean inline solution filter. Check both for damage		X				
Check wet battery water level and add distilled water if necessary		X				
Check splash guard around scrub head for damage (disk models only)		X				
Thoroughly clean entire machine		X				
Check Bromine tablet. Replace if it is 25% of the original size			X			
Check linkages and connectors for wear / damage			X			
Check all bearings and wheels for noise or loose hardware			X			
Check recovery tank lid gasket for wear or damage			X			
Check batteries for cracks, corrosion or signs of overheating			X			
Check belt for excessive wear			X			
Check all screws and nuts. Tighten if necessary			X			
Inspect isolators (orbital units only)				X		
Check for loose wires or connections				X		
Clean batteries and terminals					X	
Blow out dust in motors						X
Clean pivot points on squeegee and scrub deck linkages						X

NOTE: With regular maintenance, the lifetime of your machine and its safe operation are extended and ensured. Scheduled maintenance should be performed by qualified personnel or by an authorized service center.

⚠ WARNING: These maintenance procedures must be performed with the machine off and the batteries disconnected. Make sure to read all safety instructions prior to performing maintenance.

MAINTENANCE

END OF SHIFT

Once you've completed your daily scrubbing, project work or finish maintenance, proper end of use maintenance can greatly extend the machine's life, improve performance, enhance sanitization and lower the machine's long-term operational costs. There are four key areas we will review and demonstrate: the recovery tank, squeegee assembly, battery maintenance and charging, ending with pad and brush maintenance.

RECOVERY TANK

At the end of the job, the recovery tank needs to be emptied and rinsed out. To drain the recovery tank, utilize the recovery tank drain hose at the rear of the machine.

1. The drain hose has a press-fit cap that is removed for the draining process.
2. The hose is also equipped with a restriction collar that can be bent or squeezed to reduce splashing and spraying during the operation.
3. As the recovery tank drains, lift the recovery tank lid to the fully open position. When almost empty, begin to rinse out the sediment from the bottom of the tank with a clean water hose. After the tank is thoroughly rinsed and drained, leave the tank lid open to dry. This is a great time to inspect and clean the vacuum mesh filter screen and ball float system. This can be removed for cleaning by unscrewing the filter screen and rinsing it with a hose or faucet.
4. Empty and clean the debris tray after every use. Operating the machine without the debris tray can lead to a clogged outlet hose or facility drain.

The full access tank is designed for periodic deep cleaning and sanitizing. Once thoroughly rinsed, the operator can use a cleaner and sanitizer with a cloth or sponge to completely sanitize the recovery tank. This reduces the mold and mildew that can form over time.

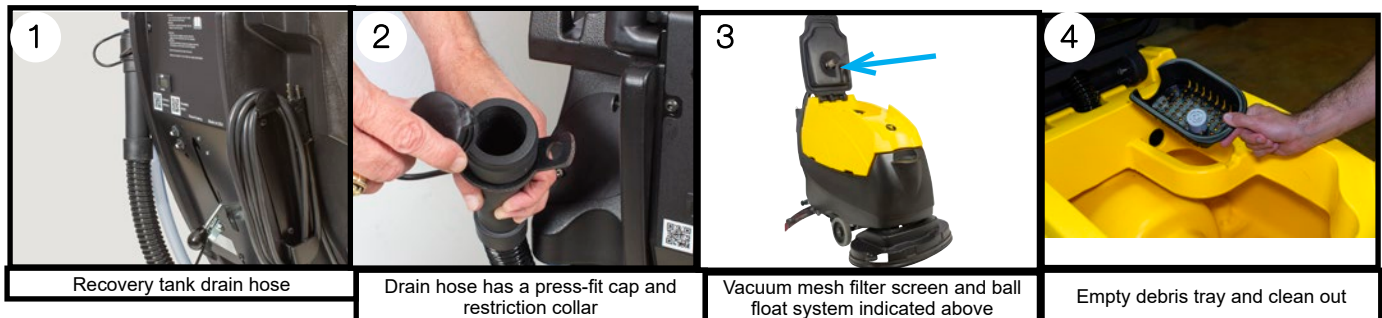

SQUEEGEE ASSEMBLY

The squeegee system is crucial to high-performance cleaning. It is the last thing that touches the floor so proper maintenance is important for making it perform at its peak.

1. Remove the squeegee assembly from the machine by loosening the easy-grip knobs and detaching the recovery hose at the back of the machine. Take the squeegee to a drain or utility sink and thoroughly rinse the underside of the squeegee frame and squeegee blades. Make sure that all particles and debris have been removed. Inspect the neck of the squeegee assembly for debris. If found, clear the debris and rinse it out.
2. Inspect the front and rear squeegee blades. If the blade edges are not clearly defined or worn halfway through the thickness of the blade, then it is time for replacement or to be flipped to another edge. The squeegee blades have four usable edges.
3. Blade exchange is completely tool-free for fast, easy maintenance. To remove the rear blade, release the over-center latch and slide the squeegee retainer off the hook on the other side.
4. The blade can be removed for replacement or flipped length wise or top to bottom to utilize another blade edge.

To re-attach the blade, align the blade holes with the squeegee frame guides from one end to the other. Slide the retainer over the hook and press the retainer latch into position on the far end following the guides. Engage the latch to finish the operation.

The front-blade exchange is completed in a similar fashion to the rear blade by removing the front blade retainer, attaching a new blade using the guides and re-engaging the squeegee retainer.

When squeegee assembly and blade maintenance is complete, re-attach the squeegee assembly by aligning the assembly, tightening the easy grip knobs and re-attaching the hose.

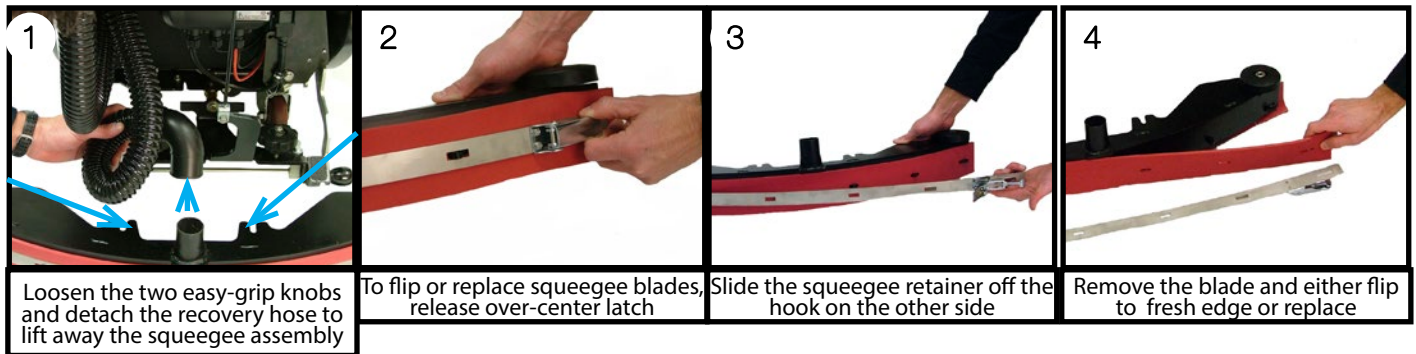

BATTERY MAINTENANCE

Based on research and experience, batteries are the number one nuisance issue and drive a high cost of ownership if not properly maintained. With the unit you can select from two types of batteries: wet, lead acid or sealed, maintenance-free AGM.

WET, LEAD ACID BATTERY MAINTENANCE

Wet batteries, by definition, need water to store energy and protect the internal lead plates. According to the supplier, here are important things to remember for a proper battery watering process:

1. Do not let the plates get exposed to air. This will corrode the plates
2. Do not fill the water level to the cap. This causes the battery to overflow acid, consequently losing capacity and causing a corrosive mess
3. Use distilled or deionized water only

STEP BY STEP BATTERY WATERING PROCEDURE

Battery watering frequency depends upon usage, but the best practice would be to check weekly. Batteries should be fully charged prior to watering. Refer to the Charging segment of this manual for charging instructions. Once charging is completed, open the vent caps and look inside the fill wells. Add distilled water until the electrolyte level is approximately 1/8 in (3.2 mm) below the bottom of the fill well. Clean and replace the vent caps.

- WARNING:** Fire or explosion hazard. Batteries emit Hydrogen gas. Keep sparks and open flame away. Keep battery compartment open when charging.
- CAUTION:** For safety, when cleaning batteries, wear protective gloves and eye protection. Avoid contact with battery acid.
- CAUTION:** For safety, when cleaning batteries, wear protective gloves and eye protection. Avoid contact with battery acid.

PAD DRIVER AND BRUSH MAINTENANCE

This portion of maintenance is simple and quick, but key to keeping your unit performing at peak levels. Remove the pad driver or brush to check for wear.

1. For the orbital unit, simply pull off the pad taking care to follow proper safety precautions as indicated on your chemical product label in regards to coming in contact with solution.
2. To remove the pad driver or brush, twist the right pad driver or brush counter-clockwise and the left one clockwise.

Should the pad or brush show ample wear and have reached their replacement point, simply discard the pad or brush and replace it at the beginning of your next shift. Brushes should be replaced when the bristle length reaches 3/4 in (19 mm).

Alternatively, if not worn out, you can extend the life of your pad driver, pad or brush by rinsing out any captured debris or sediment and then hanging it to dry between shifts - a simple step that can lower your cost to clean.

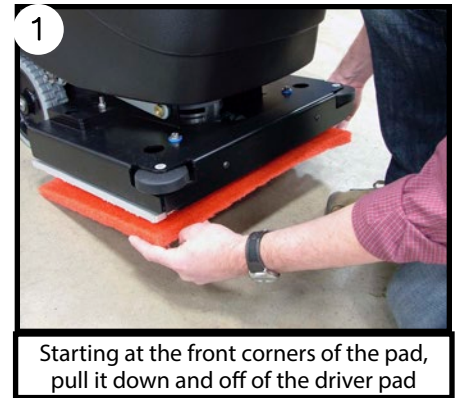

Starting at the front corners of the pad, pull it down and off of the driver pad

PERIODIC MAINTENANCE

CHANGING BATTERIES





To change the batteries in your unit, move the machine to an area with a level surface, turn off the power switch and remove the key.

1. To access the battery compartment, tilt the recovery tank to the fully open position.

2. Using proper open-ended wrench, disconnect the main ground cable first and secure terminal away from the batteries. Disconnect main positive cable and secure terminal away from the batteries. Loosen both terminals on jumper cable and remove. Attach a suitable battery lifting device and lift the batteries from the machine.

3. Reverse the order of the instructions above to install new batteries by orienting and connecting the batteries as shown in the Battery Connection Diagram. After installation is complete, be sure to charge your batteries before operating the machine.

NOTE: If changing battery types from wet, lead acid to AGM or vice versa, see Machine Preparation section for instructions on setting the dip switches on your machines battery charger before beginning the charge cycle to avoid damaging or undercharging your batteries.

-  **WARNING:** Batteries are a potential environmental hazard. Consult a battery supplier for safe disposal methods.
-  **WARNING:** Wear protective gloves and eye protection when handling batteries or battery cables. Avoid contact with battery acid.
-  **WARNING:** Disconnect battery connections before working on the machine.
-  **WARNING:** Short-circuiting or accidentally connecting battery posts or other metallic parts of the machine with a metal or conductive tool can cause serious personal injury. Use proper tools and take precautions to not accidentally short circuit battery terminals.



Fully open position allowing access to battery compartment

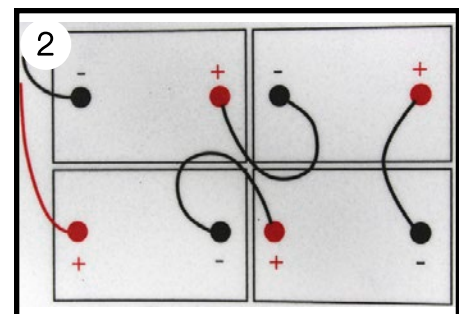

Battery Connection Diagram

PERIODIC MAINTENANCE

CHECKING THE ISOLATORS ON YOUR 28 OB ORBITAL UNIT

Your orbital scrubber is equipped with an hour meter that is located on the upper control panel.

After 300 hours, it is time to check the eight isolators located in the scrub head of the unit.

Using a flashlight, do a visual inspection of the isolators by looking through the openings in the scrub head and checking for wear or damage to four isolators in the front and four in the rear of the scrub head. The locations of the isolators are shown below.

If any of your isolators show signs of wear, degradation or damage, contact an authorized service center or Tornado technical service to find a local authorized service center to replace all eight isolators.

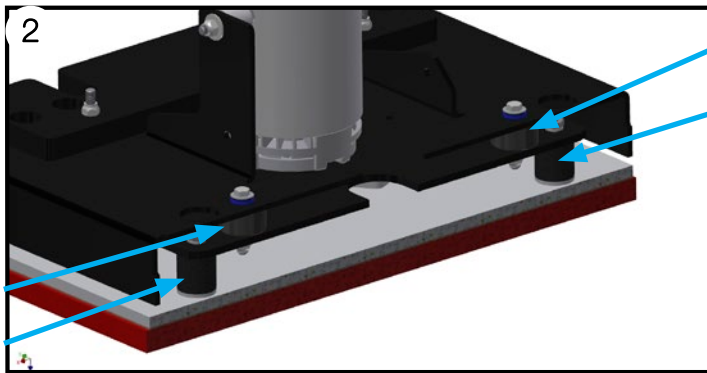

Cross section view of FRONT of orbital scrub head with isolator locations indicated with arrows

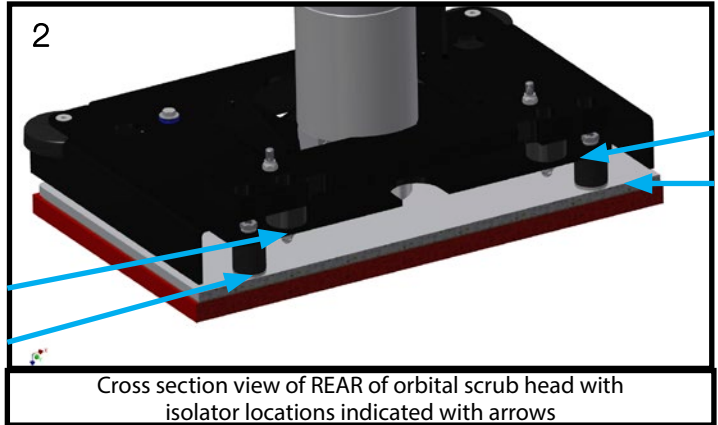

Cross section view of REAR of orbital scrub head with isolator locations indicated with arrows

TRANSPORTING YOUR UNIT

Your unit was designed so that it could easily be transported on a route cleaning program.

1. Easily transport machines in, out or through facilities with the scrubber's unique squeegee hanger feature. Simply remove the squeegee assembly (see Page 14) while leaving the recovery hose attached, lift the squeegee to a vertical position on the right side of the machine and place the squeegee tab into the squeegee hanger.
2. The machine has a tie down holes on each side of the main frame.
3. It can also be strapped down to a trailer or truck bed using tie down straps inserted between the recovery tank and solution tank.

NOTE: When transporting the machine, turn the machine off.

CAUTION: When transporting the machine, do not lift the machine when batteries are installed.

CAUTION: When transporting the machine, get assistance when lifting the machine.

NOTE: Use a recommended ramp with a maximum of a 12° incline when loading or unloading into/off truck or trailer.

NOTE: When transporting the machine, use tie down straps to secure the machine to the truck or trailer

NOTE: When transporting the machine, put the scrub head in the lowered position. Make sure the unit is off before doing so.

NOTE: Do not allow the orbital head to rest on a hard surface without a pad attached. This will cause damage to the Mighty-Lok® face.

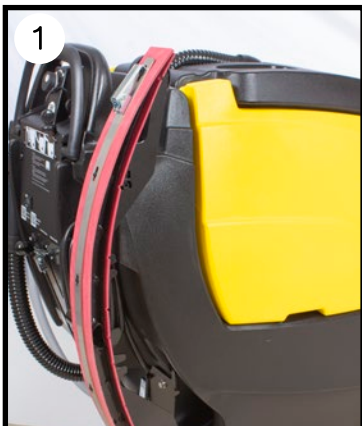

Squeegee assembly in transport position



Tie down location on main frame

TROUBLESHOOTING

OPERATOR TOP FIVE TROUBLESHOOTING LIST

Because cleaning equipment can encounter a wide array of environments and debris, various issues can arise that can be quickly fixed with some easy troubleshooting by the operator. Because there are so many scenarios, we've generated the top five troubleshooting list that addresses the most common issues.

1. MACHINE ISN'T PICKING UP WATER OR IS LEAVING A FILM ON THE FLOOR

If your machine isn't picking-up water, there are a few key areas of the machine to check. If the vacuum seems to have a higher pitch than normal, the ball float in the recovery tank has tripped because the recovery tank is full and needs to be drained. Once drained, check that the water recovery is working. If it is, then you've identified and corrected the issue.

1. If still not picking-up water, then it is likely you have a clog in the recovery hose. Start by checking the recovery hose at the lower elbow connected to the squeegee assembly.

2. Then, check the upper elbow and the recovery tank orifice. If debris is found, clear the clog with your hands or a tool. Should you have a hose available, rinse the recovery hose and tank orifice to ensure all the debris is removed.

3. If a clog isn't identified in the recovery hose, check the squeegee neck by loosening the easy grip knobs, removing the squeegee assembly and flipping it over. Clear the debris, and again, if a hose is available, rinse the squeegee opening.

4. If still not recovering properly, check your rear squeegee blade edge for wear or debris. If debris is present, clean the blade. If the edge is worn to half the blade thickness, flip to a new blade edge or order a replacement blade.

Finally, should you still have recovery issues, contact your distributor or Tornado for technical support.

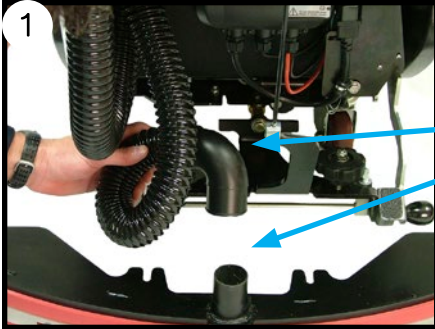

Lower elbow of recovery hose and squeegee assembly neck

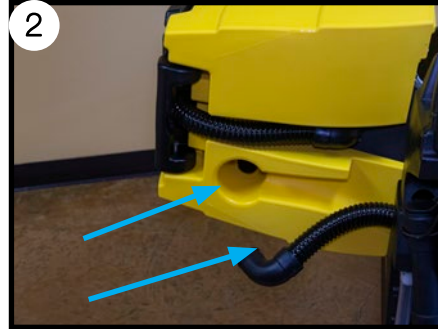

Upper elbow of recovery hose and recovery tank orifice

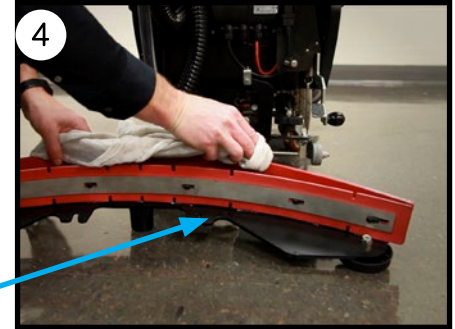

After checking for wear, wipe the blade or flip it to a new edge

2. MACHINE RUN TIME HAS DECREASED

If the machine run time has decreased, there are three potential issues that must be checked: The charger may not be plugged in or working, the wet, lead acid batteries may need watering or the batteries need to be replaced.

First, check the charger by plugging it in.

If an on-board charger, check the three LEDs. If none are on, then you likely have a faulty charger and it will need to be replaced. However, if the lights are on and the red or yellow light is on, then the batteries aren't fully charged and the charge cycle needs to be completed. If the green light is on, then the charger is working and the next step is to consider the batteries.

If the batteries are wet, lead acid batteries, check the water levels in the battery cells. If they require watering, refer to the Battery Watering segment of this manual.

If the batteries don't require watering and are over 18 months old, you've likely started to reach a point in the battery's life where their capacity is starting to decline. If you are able to meet your run time requirements, then you still have some useful life left. However, if the capacity has reduced the run time to below your requirements, then it is time to replace the batteries. See Changing Batteries segment of this manual for further instructions on how to replace your batteries.

If none of these factors are present and you are still not getting expected run times, contact your distributor or Tornado for technical support.



On-board charger LEDs

3. MACHINE WON'T DISPENSE WATER

1. First, when this issue occurs, check the solution tank sight gage for water level. If empty, fill the tank with cleaning solution.

2. Check the solution flow adjustment knob and ensure that the knob is adjusted to the solution flow level you desire.

3. If there is solution in the sight gage and the solution flow adjustment knob is properly positioned, then the filter is likely clogged with debris and needs to be cleaned. Start by draining the solution tank. Unscrew the inline filter, located on the underside of the unit between the wheels and the casters, and clean out the debris. Once clean, re-attach the filter and tighten it until snug. Ensure the screen filter element is aligned properly with the body of the filter during reassembly. Fill the solution tank and check for solution flow. If solution is flowing, you've identified the issue and you can return to cleaning.

4. Check the wire connections to the valve.

If none of the actions listed above fix the solution flow, contact your distributor or Tornado for technical support.



1
Check sight gage hose for solution level

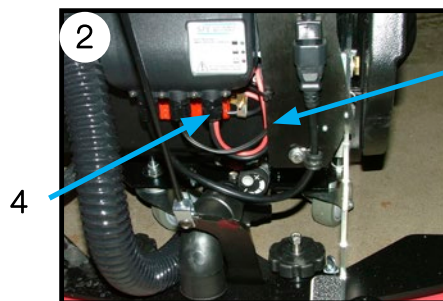

2
4
Solution flow adjustment knob and wire connections

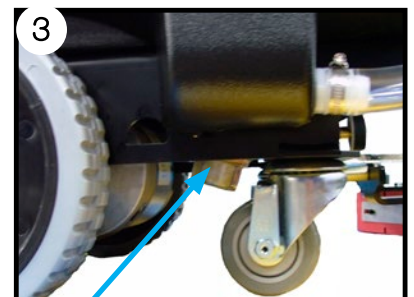

3
Sight gage hose



Inline filter screen

Inline filter cap

Sight gage hose

4. RECOVERY TANK NOT DRAINING

If your recovery tank is not draining, there is a clog somewhere in the draining system. The two main areas of potential clogging are at the tank drain or at the restriction collar on the drain hose.

1. Start by checking the restriction collar being sure to keep the hose well above the top of the recovery tank so that the water doesn't splash out once the debris is cleared. If the clog is located here, clear the clog with your hand or a tool and then drain as normal.

2. If the clog is not located at the restriction collar, then it is likely in the recovery tank at the drain opening. In this case, we suggest that the operator put rubber gloves on prior to submerging their hand to check for the clog. Once the clog is found, clear the drain and then empty as normal.

In the unlikely event that the clog is in another part of the drain hose, we encourage utilizing a water hose to back flush the clog from the recovery hose. Of course, a long thin tool of some kind can be used as well, but be extremely careful not to puncture the hose wall.

If a clog isn't found in the system, contact your distributor or Tornado for technical support.



Check for clog in the restriction collar



Check for clog in the recovery tank at the drain opening

5. SQUEEGEE ISN'T PICKING UP WATER IN TIGHT TURNS

The squeegee is designed to swing fully from left to right to the point where the squeegee system almost touches the casters. Should it be stopping well short of this, then it is likely that the recovery hose is not routed properly and has become an obstruction.

To fix this, route the recovery hose to have the loop hose trap between the squeegee assembly neck and left easy-grip knob.

If this isn't the issue, contact your distributor or Tornado for technical support.

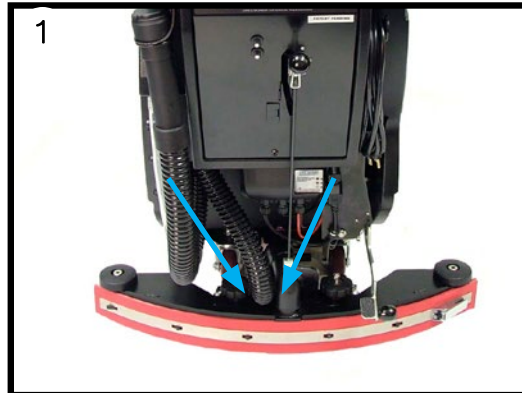

Properly routed loop hose trap placed between knob and recovery hose elbow

TROUBLESHOOTING GUIDE

ISSUE	POSSIBLE CAUSE	POSSIBLE SOLUTION
Insufficient water to the brushes	Solution flow setting is too low	Make sure the solution control valve is open by adjusting the solution flow knob
	Solution tank is empty	Check the sight gage for solution level. If low or empty, add water and detergent
	Inline solution filter may be clogged	Remove inline filter cap & screen to check for clog. Rinse and put back in place
	Solution dispensing tubes may be clogged, kinked or damaged	Visually inspect tubes
	Ball valve at the outlet of the solution tank is closed	Open valve.
Squeegee isn't drying the floor well	Squeegee blades may be dirty or worn	Remove the squeegee assembly, rinse it off and wipe the blades down. Inspect edges for damage or wear. Flip or replace blades as needed
	Recovery hose may not be secure at connections	Make sure upper recovery hose elbow is secure at the recovery tank orifice. Make sure that lower recovery hose elbow is secure on squeegee assembly neck
	Recovery hose or squeegee assembly may be obstructed	Remove recovery hose and run water through it to check for any clogs. Remove squeegee assembly and check for a clog in the neck of the assembly
	Recovery hose may be damaged	Check for damage. Replace if damage found
	Squeegee assembly height may be out of adjustment	Check the squeegee height. See Machine Preparation segment of manual for squeegee height adjustment instructions
	Ball float may be damaged or clogged and it is obstructing air flow	Check to see that the ball float is moving freely and is clean
	Recovery tank is full	Empty recovery tank
	Recovery tank lid is not sealing	Make sure that the lid is in the proper position and that there isn't damage to the gasket. Replace gasket if damage found
	Drain hose cap may be loose	Make sure cap is clean and has been pressed in tightly
	Batteries may be discharged	Check battery indicator and if necessary, recharge batteries
Machine will not turn on	Key switch may be faulty	Contact a service center to have tested
	Batteries may be discharged	Charge your batteries until charger indicates cycle is complete
	Batteries may be faulty	Replace batteries
	Battery cable(s) may be loose	Check connections and tighten if necessary

ISSUE	POSSIBLE CAUSE	POSSIBLE SOLUTION
Machine isn't cleaning satisfactorily	Pad or brush may be worn	Inspect & replace if necessary. Brushes should be replaced when the bristles reach a length of 3/4 in (19 mm)
Excessive foam is being produced in the recovery tank	Detergent used is not a low foaming detergent	Check bottle label. Use low foaming detergent or add a small quantity of defoamer to the recovery tank. More foam is generated when a floor is lightly soiled. Use less detergent if this is the case
Brush motor will not activate	Scrub head is still in the transport/storage position	Lower scrub head to operating position
	Batteries are discharged to the point that the brush motor is shut down	Recharge the batteries
	Brush motor or wiring may be faulty	Contact a service center for testing
	Brush motor circuit breaker has been tripped	Reset brush motor circuit breaker on back panel of scrubber
	Brush motor relay may be faulty	Contact a service center for testing
	Scrub head switch may be faulty	Contact a service center for testing
	Handle switch may be faulty	Contact a service center for testing
Vacuum motor will not turn on	Squeegee is still in transport/storage position	Lower squeegee to operating position
	Vacuum motor relay may be faulty	Contact a service center for testing
	Vacuum motor or wiring may be faulty	Contact a service center for testing
Vacuum motor will not turn off	Still in delay mode	Wait (10) seconds
	Faulty Vacuum Relay	Contact a service center for testing
Traction drive does not activate	Traction drive motor circuit breaker has been tripped	Reset traction drive motor circuit breaker on back panel of scrubber
	Speed control knob is turned too far to the left	Rotate knob to the right
	Traction drive motor or wiring may be faulty	Contact a service center for testing
	Traction drive motor controller may be faulty	Contact a service center for testing
Run time is short	Batteries are discharged	Recharge the batteries for a full cycle
	Wet batteries may need to be watered	See End of Shift Maintenance segment of manual
	Batteries are defective	Replace batteries
	Battery charger is defective	Repair or replace charger
	Scrub head is locked in high down pressure setting	Change scrub head setting from high down pressure setting to normal operation setting
	Charger is set to incorrect battery type	Verify dip switch setting is correct on charger using Setting the Dip Switches segment in the Machine Preparation segment of this manual

TROUBLESHOOTING GUIDE

BATTERY POWER LEVEL INDICATOR FAULT CODES

TRANSAXLE DRIVE UNITS		
CODE (FLASHING LEDs)	CAUSE	SOLUTION
One	Low voltage shut-off. Brush motor shut down	Recharge batteries
		Check battery connections
Two	Battery charge level getting low	Recharge batteries
Three	Traction drive motor tripped	Remove overload condition and reset
	Traction drive motor has short circuited	Contact a service center for testing
Four	Battery lockout has occurred	Recharge batteries right away
Eight	Controller tripped	Contact a service center for testing
Ten	High battery voltage reading	Check battery connections
None	Indicator is in sleep mode	Turn power key off then on to restore
Sequencing lights	Activation handle is engaged	Release activation bail

This page intentionally left blank



TORNADO[®]

Warranty Registration Form

Please Print Clearly

Company/Institution	
Contact Name	Title
Address	City/State/Zip Code
Phone	Fax
Date of Purchase	Email
Selling Dealer:(Required)	

See white metal plate or sticker on unit for this information.

MACHINE TYPE/MODEL NUMBER:	MACHINE SERIAL NUMBER:
1.	1.
2.	2.
3.	3.
4.	4.

Facility Description (please circle all that apply)			
1. School	6. Manufacturing	11. Airport	16. Other Govt.
2. Retail Store	7. College/University	12. Warehouse	17. Auto Service
3. Restaurant	8. Hospital	13. Apartment/Condo	18. Non-Profit
4. Office Building	9. Nursing Home	14. Supermarket	19. Other (specify)
5. Contract Cleaning	10. Religious Institution	15. U.S. Govt	

<p>How did you first learn about Tornado cleaning and maintenance equipment?</p> <ul style="list-style-type: none"> <input type="radio"/> Contacted by local dealer <input type="radio"/> Previous experience with Tornado products <input type="radio"/> Reputation/Recommendation <input type="radio"/> Advertising <input type="radio"/> Direct mail <input type="radio"/> Website: _____ <input type="radio"/> Blog: _____ <input type="radio"/> Other 	<p>You can complete this form online at www.tornadovac.com/services/warranty-registration-form.aspx</p> <p>This form may also be returned to :</p> <p>Tornado Industries 3101 Wichita Court Fort Worth, TX 76140 Fax: 817-551-0719</p>
--	--

Damage or defect arising from abuse, neglect or other misuse is excluded from this warranty. Other items may or may not apply based on your specific machine. If any defect occurs, and service is attempted by non-Authorized Tornado Service Centers, the warranty will be void.