

Quick Start Guide PS Spotter/98220

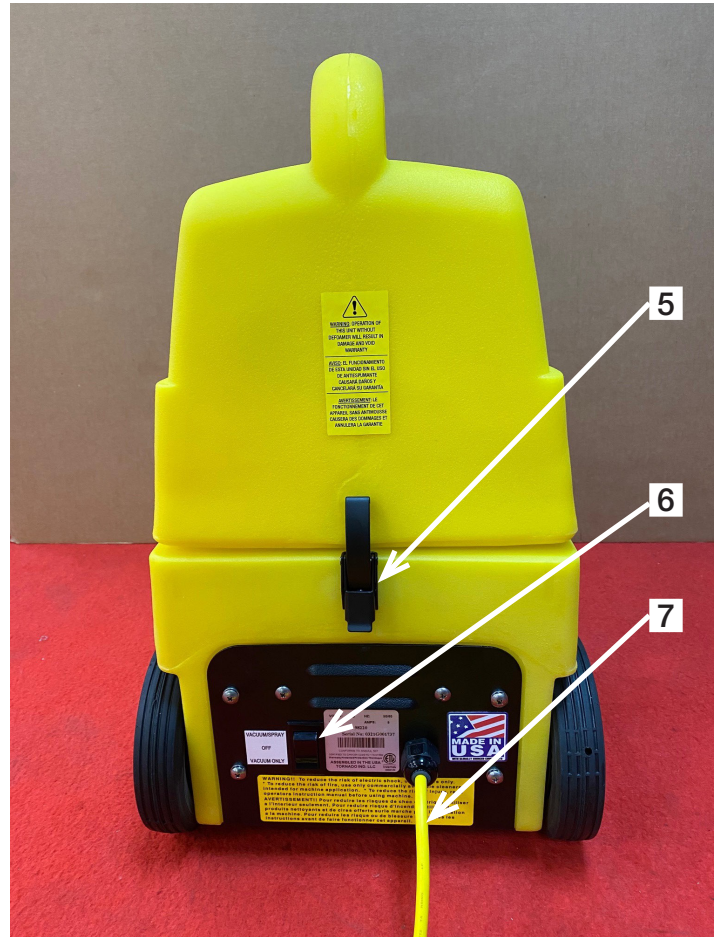
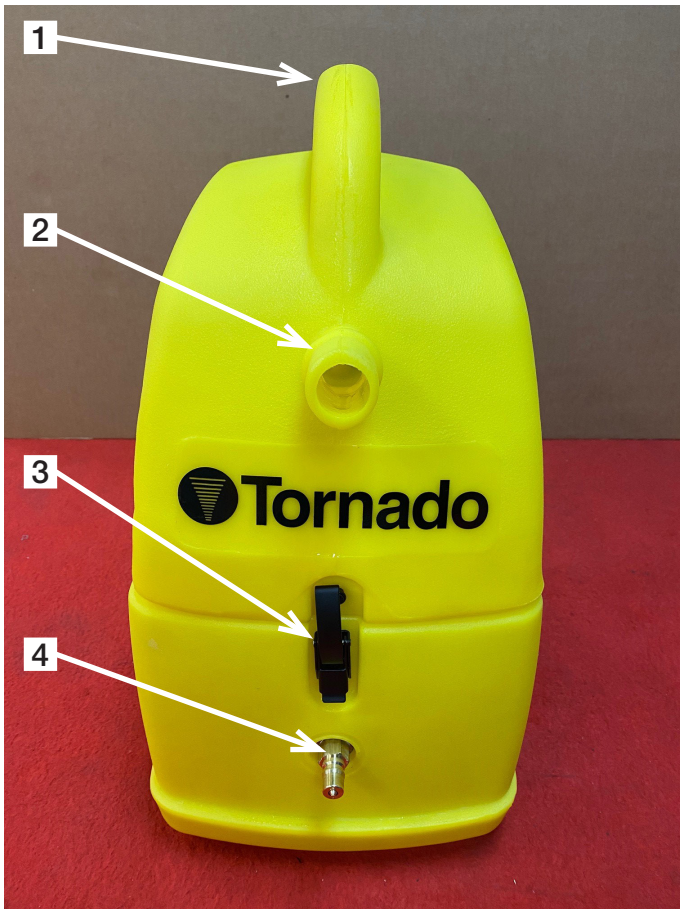
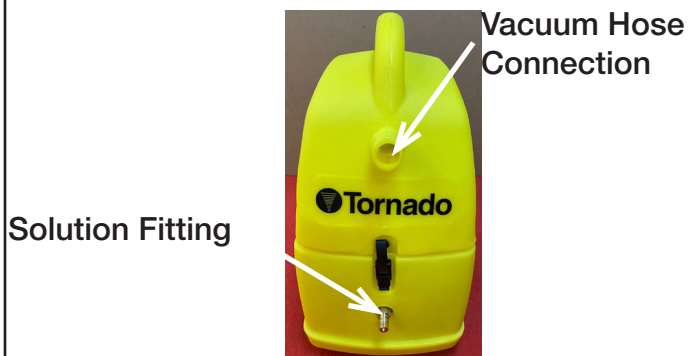

Fig. 1

1	Carrying Handle
2	Vacuum Hose Connection
3	Front Latch Assembly
4	Solution Hose Connection
5	Rear Latch Assembly
6	Power Switch
7	Power Cord Assembly

1. Assembly

1



1. Attach solution hose to solution hose connection (Fig. 1 #4). Be sure hose coupler locks onto extractor's coupler.
2. Connect vacuum hose to vacuum hose connection (Fig. 1 #2).

2

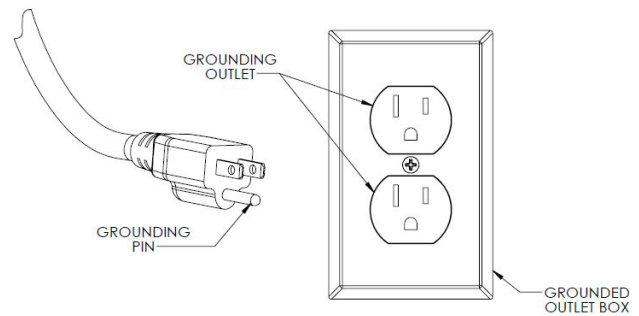

Plug the power cord into a grounded 15 amp wall socket circuit.

2. Operating Instructions



Loosen the front (Fig.1 #3) and rear (Fig. 1 #5) latch assemblies that hold the recovery tank onto the solution tank. Lift the recovery tank off.

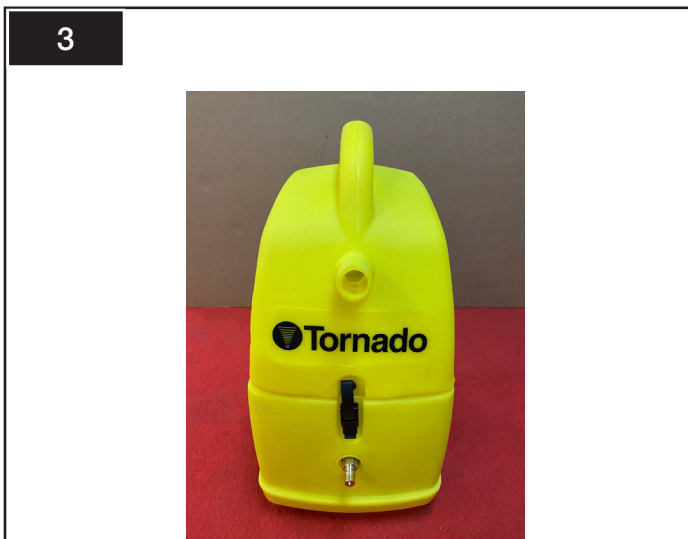

Place the recovery tank on the solution tank and refasten the tank latches.

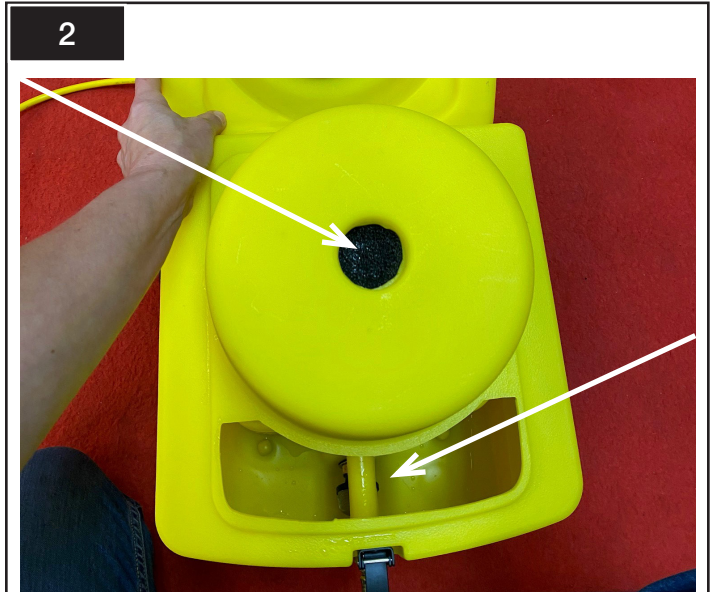

Pour up to 2 gallons (7.6 liters) of hot water into clean solution tank fill opening. Pour in a nonfoaming cleaning concentrate to the proper dilution noted on the container. Be sure that the vacuum motor foam filter is in place (located on top of the solution tank).

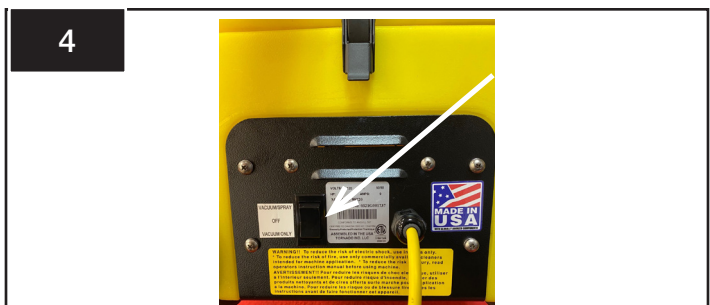

1. Turn the switch, located on the rear panel, to "VACUUM/SPRAY".
2. Place the hand tool on the surface to be cleaned and squeeze the solution lever.
3. Move tool over surface to be cleaned.

3. Additional Parts Required

There are no additional parts required for the unit.