



PAC-VAC[™] 6 ROAM

OPERATIONS AND MAINTENANCE MANUAL
FOR COMMERCIAL USE ONLY



Model No. 93016B-1

CONTENTS

Getting Started

Introduction	3
Warnings	4
Important Battery Information	5
Important Safety Instructions	6
Wearing the Backpack Vacuum	10
Operation Instructions	11
Maintenance	16
Box Contents and Tool Kit	17

INTRODUCTION

Your new Tornado unit is a high quality, precision-made product. All parts used in the manufacturing of this unit have passed rigid quality control standards prior to assembly. Please safeguard the original receipt / invoice. If you experience any problems with your unit during the warranty period, the original receipt / invoice will act as proof of purchase. Contact Tornado for any warranty inquiries.

Check the carton for shipping damage. Carefully unpack and inspect your new Tornado vacuum for shipping damage. Each unit is tested and thoroughly inspected prior to shipping. If damage is discovered, immediately notify the transportation company that delivered your machine and request an inspection. As a manufacturer, we are unable to act upon any claim for concealed damage; you must originate the claim. Be sure to keep the carton, packing inserts, packing lists, and carrier's receipt until the inspector has verified your claim.



Protect the environment

Please dispose of packaging materials in an environmentally safe way according to local waste disposal regulations.

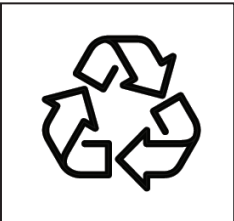

Always remember to recycle.



RECYCLING BATTERIES

Proper disposal and recycling batteries is mandatory under the Mercury Containing Rechargeable Battery management Act, 42 U.S.S. 14301-14336 ("Battery Act")

The 'Charge Up to Recycle!' program offers various recycling plans for communities, retailers, businesses, and public agencies. For more information about the "Charge Up to Recycle!" program, or for more information about a local collection site visit www.rbrc.com or call RBRC's toll free number 1-800-8-BATTERY.

WARNINGS



Warranty

Within 30 days of purchase, to activate product warranty, go to:
<https://tornadovac.com/services/warranty-registration-form.aspx>
For warranty information go to www.tornadovac.com.



Warning Labels

Prior to operating the unit, read and understand completely this owner's manual paying special attention to warning labels. These labels indicate a potentially hazardous situation that could result in death or serious injury if not avoided. Use only as described in this manual.



Important

There are no owner serviceable parts inside this machine. Removal of screws and accessing internal components will void all warranty claims.



Flammability Warning

NEVER fill unit with flammable chemicals. **DO NOT** use in an area where flammable fumes are present.

IMPORTANT BATTERY INFORMATION

ATTENTION

The battery for this unit is shipped in a mode that requires an initial charge to activate that can take approximately 3 hours to complete. Once fully charged, the LED indicator on the charger will change from RED to GREEN. Charge time can vary, depending on where the charger is located. For best results, locate your charger away from direct sunlight, in a room that has good air movement and a temperature between 50-86 °F (10-30 °C). The Charger light could remain GREEN when plugged into a warm battery. The charger light will change to RED once the battery cools and charging begins.

ATTENTION

An added feature to the battery is the inclusion of a sleep mode element to the battery circuitry in order to minimize battery discharge during shipment and subsequent storage. The normal state of a battery, or active mode, includes a "fuel gauge" that is always ON and monitoring the state of the cells in the battery. This state causes the battery to discharge faster than when in sleep mode where the fuel gauge turns on and off a few times a minute to collect data from the cells of the battery. Sleep mode lessens the discharge seep inherent in batteries and is automatic whenever the battery is not charging or discharging.

**THE BATTERY MUST BE CHARGED TO "WAKE IT UP"
OUT OF SLEEP MODE PRIOR TO INITIAL USE.**

ATTENTION

There will be a small delay when the unit is switched ON after inserting a battery into the unit. This function will prevent the misuse of the unit due to the possibility of a HOT start.

IMPORTANT SAFETY INSTRUCTIONS

Read and understand this owner's manual and all labels on the unit before operating. Safety is a combination of common sense, staying alert and knowing how your unit works. Use this unit only as described in this manual. Use only manufacturer's recommended attachments. To reduce the risk of personal injury or damage to your unit use only Tornado recommended accessories.

SAFETY PRECAUTIONS

Do not operate the vacuum while it is standing on high pile carpet/ It is essential that the exhaust airflow not be restricted. Do not wash or launder the cloth bag as this will destroy the filtration capacity of the fabric.

GENERAL PRECAUTIONS

- You must be trained in the operation of this machine before use. Please read this manual carefully and obtain operation instructions from your safety director or your authorized Tornado distributor.
- Do not attempt to repair warranted machines. All repairs must be done by a qualified and authorized repair center. Non warranted repairs will be billed back to the owner of the unit.
- Do not use any replacement parts except those specified in the parts list. Unauthorized parts could cause the unit to malfunction and will void the warranty.

FAILURE TO COMPLY WITH THE ABOVE WARNING INSTRUCTIONS WILL VOID THE WARRANTY

Disconnect the battery pack from the appliance before making any adjustments, changing accessories, or storing appliance. Such preventive safety measures reduce the risk of starting the appliance accidentally.

SAVE THESE INSTRUCTIONS

IMPORTANT SAFETY INSTRUCTIONS



CAUTION

Under abusive conditions, liquid may be ejected from the battery; avoid contact. If contact accidentally occurs, flush with water. If liquid contacts eyes, additionally seek medical help. Liquid ejected from the battery may cause irritation or burns.



FOR COMMERCIAL USE ONLY

When using an electrical appliance, basic precautions should always be followed including the following.



To reduce the risk of fire, electric shock, or injury:

- To avoid electrical shock, Use indoors only. Do not use outdoors and do not expose to rain.
- Do not allow to be used as a toy. Close attention is necessary when used by or near children.
- Use only as described in this manual. Use only manufacturer's recommended attachment.
- Keep hair, loose clothing, fingers, and all parts of body away from openings and moving parts.
- Always keep hands feet and loose fitting clothing away from moving parts to prevent possible injuries.
- Do not use machine in areas where flammable and/or explosive vapors or dusts are present.
- Make sure voltage and frequency at the wall receptacle correspond with that indicated on nameplate before plugging in machine.
- Use extra care when cleaning on stairs.
- Do not pick up anything that is burning or smoking such as cigarettes, matches, or hot ashes.
- Do not use without dust bag and/or filters in place.

SAVE THESE INSTRUCTIONS

IMPORTANT SAFETY INSTRUCTIONS



BATTERY AND CHARGING SAFELY

To reduce the risk of electric shock, fire, battery explosion, or injury:

1. Use only Tornado charger X1194A and Tornado battery pack X1200C
2. DO NOT expose battery packs to temperatures above 122°F (50°C). Never leave battery packs in automobiles on hot days, where temperatures can be much higher than the outside temperature.
3. DO NOT use or store vacuum or batteries in wet or moist conditions, or with flammable or combustible materials.
4. DO NOT charge batteries or store battery for extended periods, 1 month or more, in temperatures above 90°F (32°C) or below 40°F (5°C).
5. When charging, make sure that the charger has at least 6 inches of clearance on all sides. Adequate airflow is required to cool the charger when in use.
6. Connect charging cord to a properly grounded outlet only. See Grounding Instructions.
7. DO NOT use a damaged cord or plug for charging.
8. DO NOT pull on charger's cord to unplug. Grasp and pull the plug, not the cord.
9. DO NOT handle the charger's cord plug with wet hands when inserting into electrical outlet.
10. Keep sparks and flames away from batteries.
11. DO NOT smoke near batteries or charger.
12. DO NOT charge the unit outdoors.
13. DO NOT attempt to repair, service, or modify the battery system or charger. Contact Tornado Customer Service with any issues.
14. DO NOT short-circuit the battery or charger terminals with conductive items such as paper clips. This can deliver high current, resulting in heat and fire.
15. DO NOT crush, drop, incinerate or damage the battery pack.
16. DO NOT use a battery pack that has been damaged in any way.
17. DO NOT incinerate the battery even if it is severely damaged or nonworking. The battery can explode in a fire.

SAVE THESE INSTRUCTIONS

IMPORTANT SAFETY INSTRUCTIONS



To avoid damage to the battery contacts, turn off power switch before reconnecting the battery. Battery must be fully engaged to insure proper electrical connection.

INSTALLING BATTERY PACK INTO VACUUM

1. Holding battery by the front, carefully slide the battery into the lower housing until it clicks in place (**Fig. 1**).
2. Connector is spring-loaded. Battery will need to be pushed fully into position.

BATTERY FUEL GAUGE

1. The battery fuel gauge indicates the approximate run time remaining on the battery.
2. When the battery button is pressed, one to four indicators will light up, indicating the approximate battery charge remaining as follows:

Fig. 1

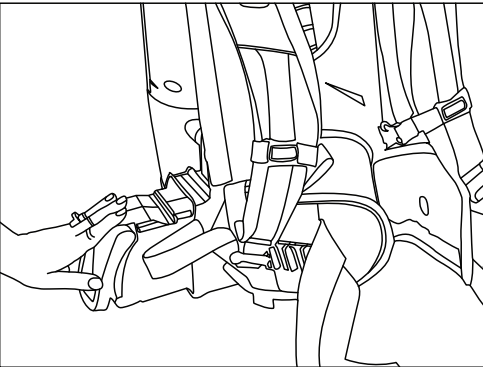

- All 4 lights on:** Full Charge
- 3 lights on:** 70% Charge
- 2 lights on:** 45% Charge
- 1 light on:** 25% Charge
- 1 light on and blinking:** Low battery, charge when possible

SAVE THESE INSTRUCTIONS

WEARING THE BACKPACK VACUUM

PAC-VAC® 6 AND 10 AIRCOMFORT

The Patented Aircomfort System Includes:

1. Aircomfort harness allows air to escape from three sides, reducing wearer perspiration by up to 25% over a normal closed back system, positively impacting the operator's body temperature
2. Aluminum stays weight to the hip-belt, enhancing the stability of the integrated aircomfort back system.
3. Anatomically shaped shoulder straps with 3D air mesh lining.
4. Contoured hip belt with bilaminate foam reinforced with PE provides comfort for the hips.

The Deuter Aircomfort harness system on Tornado's Pac-Vac 6 and 10 Aircomfort Series offers five unique adjustments, ensuring a secure, cool, and individualized fit.

- a. Patented Vari-Quick System
- b. Shoulder straps
- c. Hip belt
- d. Sternum straps
- e. Stabilizer straps

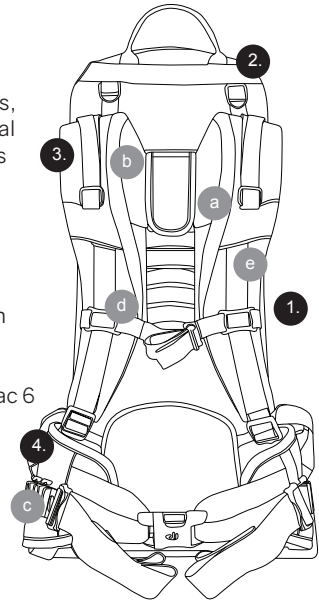

FIG. 2

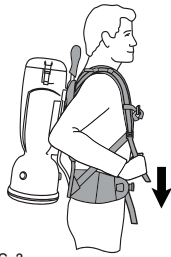

FIG. 3



FIG. 4

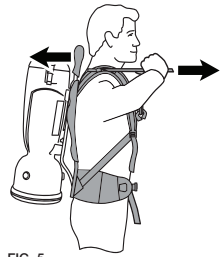

FIG. 5

The backpack is designed to balance the weight of the vacuum on the hips, not the shoulders.

1. Adjust the Vari-Quick height adjuster to your back length.
2. Loosen all of the straps and place the vacuum on your back.
3. Place the hip belt over your hip and connect the buckle. Your hip bones should be centered between the top and bottom of the belt. Pull the straps forward to tighten the hip belt. **(Fig. 2)**
4. Pull down the shoulder straps to tighten the backpack on your shoulders. **(Fig. 3)**
Do not tighten too tight. The main weight of the vac
5. Adjust the sternum strap on a comfortable part of your chest and close the strap. **(Fig. 4)**
6. Loosen or tighten the stabilizer straps as needed, to fit your back. **(Fig. 5)**
7. Do final adjustments on the shoulder and stabilizer straps as needed to balance the weight of the vacuum on the hips.

OPERATION INSTRUCTIONS

Please read the following operating instructions carefully. They will help you to get the best performance from this professional quality vacuum cleaner and to maintain it in optimum condition. Follow these simple steps for easy and effective operation of the Backpack vacuum.

Open the lid and ensure that the cloth bag is correctly located and the flexible ring provides a proper seal when the lid is closed. For optimum performance, filtration and maximum hygiene, it is advisable to use a paper vacuum bag in addition to the standard cloth bag.

If a paper vacuum bag is used, simply insert it into the cloth bag, making sure that the cardboard disk is centered on the flexible sealing ring. When you replace the lid, the short nozzle in the center of the lid will be forced into the central hole of the cardboard disk of the paper vacuum bag thus providing a tight seal. Make sure the paper vacuum bag is tightly secured over the short nozzle before vacuuming.

Lock the lid down with the two latches. Always ensure that the cloth vacuum bag is empty and the paper bag is no more than 1/2 full before vacuuming. The vacuum hose is fitted into the cuff in the lid. It should not be necessary to remove the hose in normal operation.

1. Place the Backpack vacuum on your back, adjust the shoulder straps until you feel comfortable and then tighten the waist belt. The Backpack vacuum is designed to ride higher on your back for maximum comfort.
2. Attach the extension wand to the hose and fit the floor tool or any of the other vacuuming accessories on the wand.
3. Turn the vacuum on. The toggle switch is located on the lower housing.
4. After you finish cleaning, turn off the main power switch.

OPERATION INSTRUCTIONS

PREPARING BATTERY PACK FOR CHARGING

1. Plug the charger's power cord into the battery (**Fig. 6**).
2. Plug the charger's power cord into 120V wall outlet (**Fig. 7**).
3. The indicator light should turn Red and blink while charging and turn Green when fully charged (**Fig. 8**). The battery pack may require approximately 2.5 hours to fully charge.
4. Verify the charge level of the battery pack by pressing the power level indicator button on the front of the pack. (**Fig. 9**). Four lights (one red and three green) indicate a fully charged battery. Unplug battery from charger and unplug cord from wall outlet after charging.

Battery pack may get warm while charging.

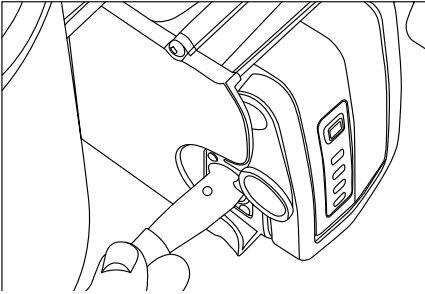

Fig. 6

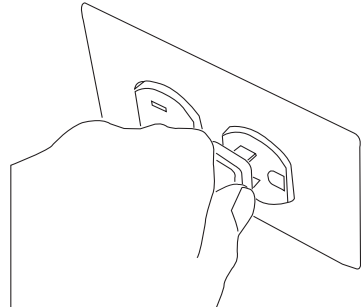

Fig. 7

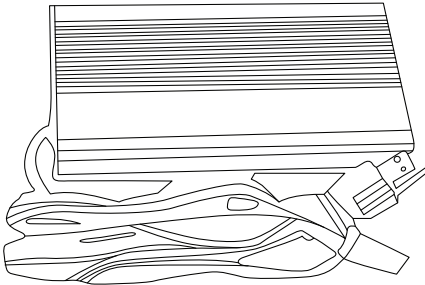

Fig. 8

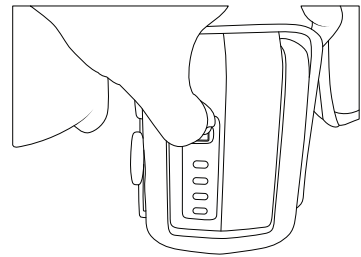

Fig. 9

OPERATION INSTRUCTIONS

TO CHANGE THE FILTER COLLECTION BAGS

- Turn off the main power switch (**Fig. 10**).
- Remove vacuum hose from top of unit (**Fig 11**).
- Release the two latches and lift off lid (**Fig. 12**).
- Separate lid from paper bag insert and dispose of paper bag (**Fig. 13**).
- Remove cloth filter bag, clean, dust and replace (**Fig. 14**).
- Insert new paper bag making sure to align lid nozzle with bag hole and replace latches (**Fig. 15**).

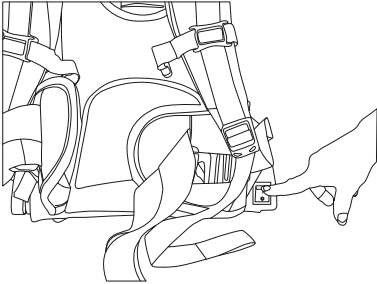

Fig. 10

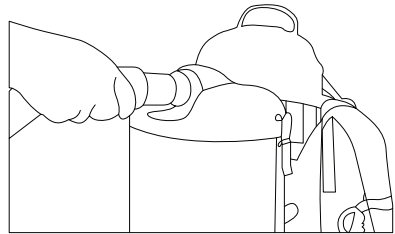

Fig. 11



Fig. 12

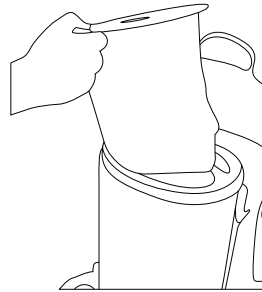

Fig. 13



Fig. 14

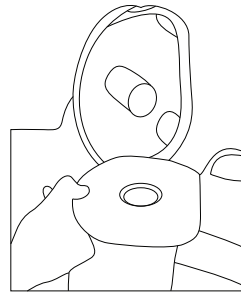

Fig. 15

OPERATION INSTRUCTIONS

CHANGING EXHAUST FILTER ASSEMBLY

The Pac-Vac vacuum cleaner is equipped with a HEPA filter and an exhaust filter. These filters capture fine dust particles and protect the motor from dirt. It is important to replace the HEPA filter approximately every six months. Replace the exhaust filter every fourth time the paper vacuum bags are changed.

To change or clean the exhaust filter

1. Turn off the main power switch (**Fig. 10**).
2. Detach the exhaust filter holder from the bottom of the unit (**Fig. 16**)
3. Remove the exhaust filter from the holder (**Fig. 17**)
4. DO NOT THROW AWAY THE FILTER HOLDER.
5. Remove the exhaust filter from the plastic holder and shake or brush dirt from the filter.
6. Replace the exhaust filter in the plastic holder and place into vacuum.

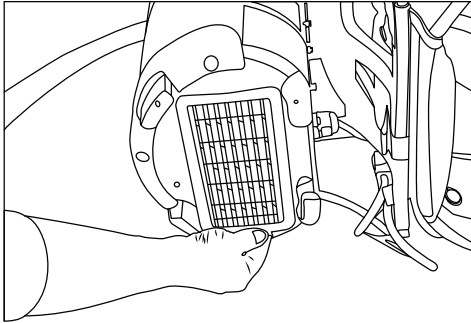

Fig. 16

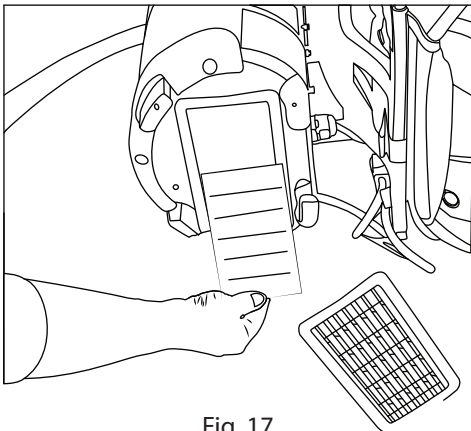

Fig. 17

OPERATION INSTRUCTIONS

CHANGING HEPA FILTER ASSEMBLY

To change the HEPA filter:

1. Remove the lid, paper bag and cloth bag to expose the HEPA filter.
2. Remove the filter cap on the top of the HEPA filter (**Fig. 18**)
3. Remove the HEPA filter from the dust compartment
4. Insert a new HEPA filter and replace the filter cap (**Fig. 19**). Refit the cloth bag, paper bag, and replace lid.

Note: The HEPA filter can NOT be washed and reused.

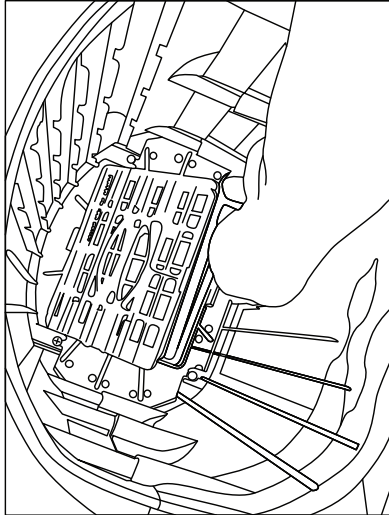

Fig. 18-19

MAINTENANCE

Clean the cloth vacuum bag regularly. After emptying the vacuum bag, turn it inside out and shake as much dust out of the fabric as possible. Optimum performance is achieved by using a paper filter bag with the cloth bag.

Clean the vacuum bag and HEPA filter or free any blockage and ensure that adequate airflow is restored.

Use only approved Tornado paper filter bags.

Ensure the vacuum hose, the extension wand and the vacuuming accessories are not blocked.

Have your unit serviced by an authorized repair service center if you suspect any potential problems.

Ensure that the flexible vacuum bag ring provides a proper seal before vacuuming.

RECOMMENDED REPLACEMENT PARTS:

C352-2500	Paper Bag (10 pack)
B352-2400	Motor Exhaust Micro Filter
B352-2401	HEPA Filter
C352-1400	Shake Out Bag
X1208	Motor
X1200C	Battery
X1194A	Battery Charger w/Cord

BOX CONTENTS & TOOL KIT

Upon initial receipt of unit, open box and ensure all parts are included as shown below:

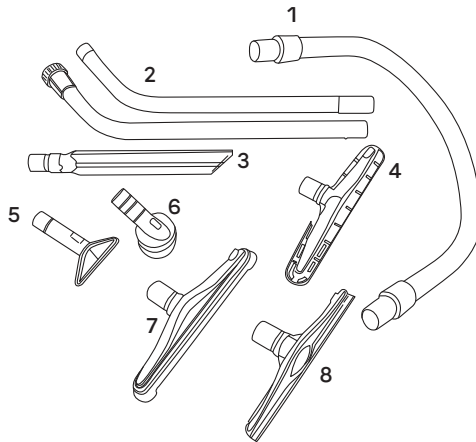
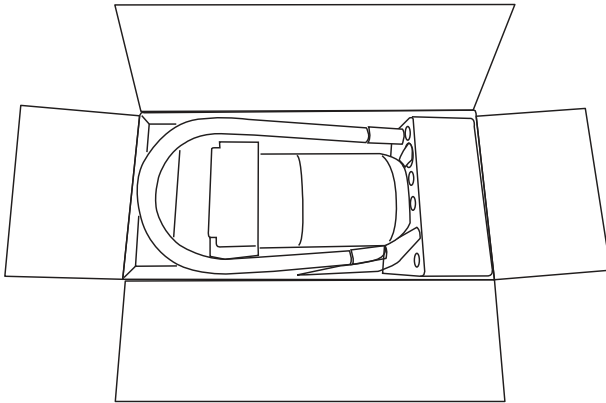

No.	Part No.	Description
1	A352-6900	Hose
2	CT171	Wand
3	CT176	Crevice Tool
4	B352-PF10	Carpet Tool
5	CT188	Upholstery Tool
6	CT184	Dusting Tool
7	C352-PF20	Hard Floor Tool
8	CT194	Easy Glide carpet Tool

NOTES



Tornado Industries, LLC
3101 Wichita Court
Ft. Worth, TX 76140-1755
Phone: 800-VACUUMS
Fax: 1-817-551-0719
WWW.TORNADOVAC.COM



Record of Purchase

Serial Number: _____
Purchase Date: _____
Dealer: _____
Phone Number: _____