

HOLO Series HL25 User Manual

V1.0

InfiRay Technologies Co., Ltd.

Specifications

Model	HOLO-HL25
Detector Parameters	
Type	Uncooled Vox
Resolution	384x288
Pixel Size, μm	12
NETD, mk	≤ 40
Frame Rate, Hz	50
Optical Characteristics	
Objective Lens, mm	25
FOV	$10.5^\circ \times 7.9^\circ$
Digital Zoom, \times	$\times 1, \times 2, \times 3, \times 4$
Detection Range, m (Target Size: $1.7\text{m} \times 0.5\text{m}$, $P(n)=99\%$)	1300
Display Parameters	
Type	2.6" AMOLED
Resolution	800x600
Power Supply	
Battery Type/Capacity/Output Voltage	18500/ 1500mAh /3.7V
Max. Operating Time (at temp.=22°C), h*	≤ 4.5
External Interface Power Supply	5V (Type C)
Physical Characteristics	
IP Rating	IP67
Amount of Built-in Memory, GB	32
Operating Temperature, °C	-20~+50
Weight (without battery), g	<500
Dimension, mm	66×90×90

Improvements may be made to the design and software of this product to enhance its features without prior notice;

I. Package Contents

- HOLO Thermal Imager
- Heated target for zeroing
- USB cable
- Lens cloth
- Extended battery cover-18650

II. Description

HOLO-HL25 is a new generation of holographic thermal imager featured with long working time and good concealment. It has a large screen with high definition display, which can penetrate smoke, dust or dark night. It is suitable for general thermal search and targeting applications and can be widely used for hunting, searching and positioning under various outdoor conditions.

III. Product Features

- 12 μ m self-developed detector;
- High image quality;
- HD AMOLED display
- 50Hz frame rate;
- Built-in memory space, supporting photo taking and video recording;
- PIP (picture-in-picture) function;
- Convenient operation interface;
- Quick-release picatinny rail clamp

IV. Device Composition

1. Display
2. Five-way button
3. Power button
4. Clamping pressure plate
5. Nut
6. Battery holder cover

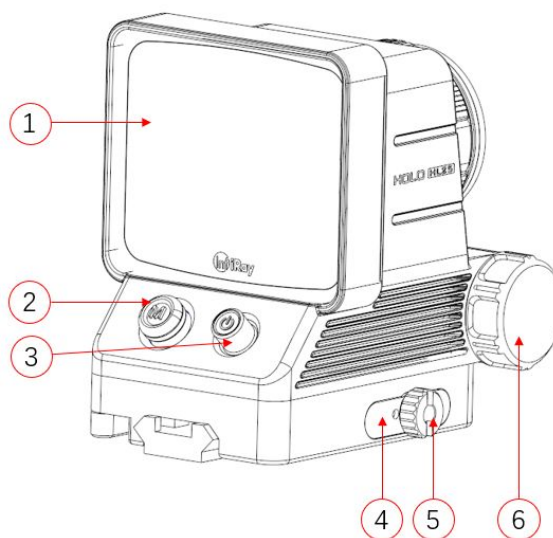

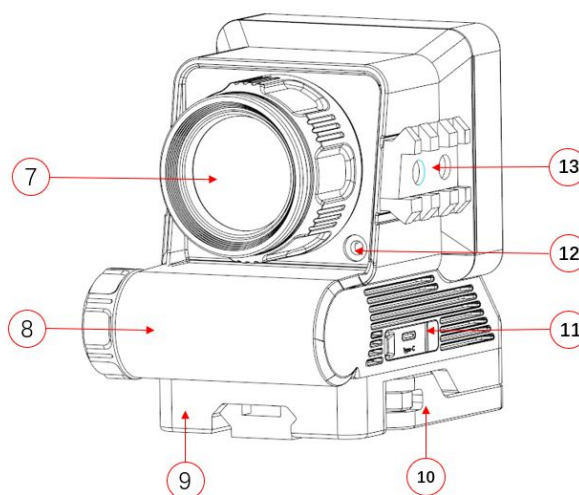

7. Lens
8. Battery compartment
9. Fixture
10. Locking wrench
11. Type-C interface
12. Laser
13. Side picatinny rail



V. Button Operations

Button	Device status/ Current operation mode	Press	Press and hold
Power button 	Powered off	---	Power on the device
	Always-on interface	Shutter	Shutdown after 3s / standby before 3s
	Advanced menu	Return to the upper level	---
Up ↑ Button	Always-on interface	Digital zoom (1.0×--4.0×)	PIP on/off
	Shortcut Menu	Reticle Color	

(Zoom Button) 	Advanced menu	Move up	---
Down ↓ Button (Calibration Button) C	Always-on interface	Photo Taking	Start/end Recording
	Shortcut Menu	Reticle Type	
	Advanced menu	Move Down	
Left ← Button/Palette Button P	Always-on interface	Palette mode	Stadiametric Ranging/continuous ranging
	Shortcut Menu	Zeroing distance	---
	Advanced menu	Move left	
Right → Button/Brightness Button 	Always-on interface	Screen brightness (1.0× to 5.0×)	Single ranging
	Shortcut Menu	Laser switching (10m/ 30m/ 50m/ off)	---
	Advanced menu	Move right	
Menu Button (M Button) M	Always-on interface	Open the shortcut menu	Enter the advanced menu
	Advanced menu	Switch on and off/Enter the next-level options/Confirm the current option parameters	Save and return to the upper menu
	Pixel Defect Correction	Add/delete defective pixels	Save/cancel calibration

Remarks: If there is no connected rangefinding module, press and hold the button on the right at the always-on interface to enable the stadiametric rangefinding;

If the purchased rangefinding module is connected, press and hold the left and right buttons at the always-on interface to enable continuous or single ranging;

VI. Battery Installation

- Turn anticlockwise to open the battery holder cover (6) as shown in the figure;

- Install one 18500 battery (14) according to the device body battery installation instruction icon, i.e. the positive pole of the battery faces inward and the negative pole faces outward, and put it into the battery compartment;
- Close the battery holder cover (6) and turn clockwise to tighten it.

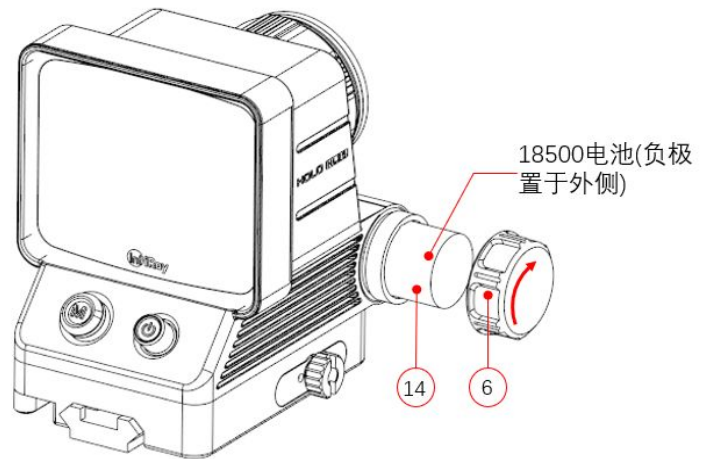

★ **Special description:**

This device can also be connected to an external power supply through the Type-C interface data cable. There is no need to remove the battery, but it cannot charge the rechargeable battery.

七、Operating Instructions

7.1 Startup and Shutdown

When the power is off, press and hold the Power Button, the thermal imager starts, and the screen displays the image.

When the power is on, press and hold the Power Button, the thermal imager shuts down.

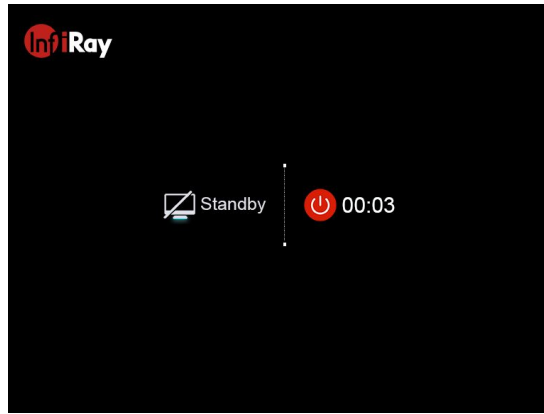

7.2 Status Bar Display

When the thermal imager is on, a row of status bars is displayed above the image, as shown in the following figure.

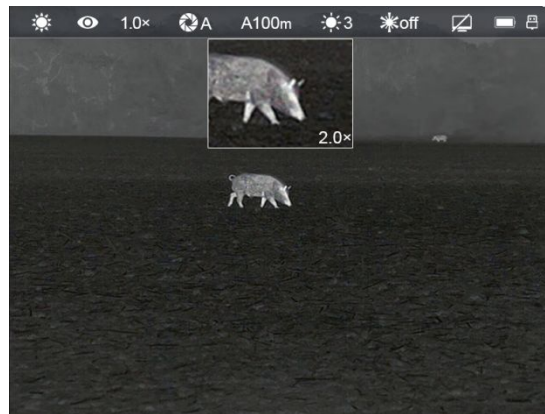

The top status bar from left to right is:

- Palette mode: white hot, black hot, red hot, pseudo-color, target highlighting (white hot by default)
- Ultra-clear mode: on/off (off by default)
- Digital zoom: 1×, 2×, 3×, 4× (1× by default)
- Shutter mode: automatic shutter A / manual shutter M (automatic mode by default)
- Gun type: A / B / C (A by default)
- Screen brightness: 1 to 5 (3 by default)
- Lasers :10m / 20m / 50m / off (off by default)
- Standby shutdown: on/off (on by default)
- Battery icon, USB icon

7.3 Always-on Interface

After startup, enter the always-on interface.



- Press the ↑ button – **digital zoom**. 1×, 2×, 3× and 4× changed in order on the home screen. The top status bar is updated in real time. (1x by default);
- Press and hold the ↑ button – **PIP**, enabled or not. The magnification values 2x, 4x, 6x, 8x (off by default) are displayed in PIP.
- Press the ↓ button – **take photo**. If the camera icon flashes once, it indicates that the photo has been taken;
- Press and hold the ↓ button – **recording**. Press and hold to start video recording, and repeat the operation to end and save recording;
- Press the ← button – **palette mode**. White hot, black hot, red hot, pseudo-color and target highlighting circulate in order (white hot by default);
- Press and hold ← button – **stadiametric rangefinding**. press and hold to enable stadiametric rangefinding, and repeat the operation to disable it;

If the rangefinding module is connected, press and hold to enable continuous ranging, and repeat the operation to disable it (disabled by default);

- Press the → button (brightness button) – **screen brightness**. Level 1 to 5 circulate in order (Level 3 by default);
- Press and hold the → button (brightness button) – **single-point rangefinding**. If the rangefinding module is connected, press and hold to enable single-point rangefinding and disable the brightness function. Repeat the operation to disable single-point rangefinding (disabled by default).

7.4 Shortcut Menu

On the home screen, **press the M button** to enter the shortcut menu; press and hold the M button to save and return to the upper menu, namely the home screen. The shortcut menu function information is displayed on the interface:

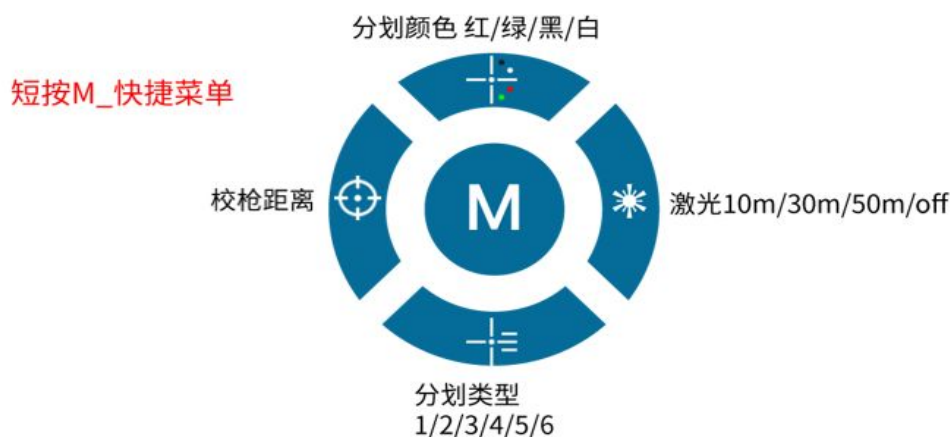

- ↑ **Button** – reticle color. Press the **Up Button** in turn to [switch the reticle colors](#) (black/white/red/green in sequence). (black by default)
- ↓ **Button** – reticle type. Press the **Down Button** in turn to [switch the reticle types](#) from 1 to 6. (1 by default)
- ← **Button** – zeroing distance. Press the **Left Button** in turn to switch the zeroing distance (100m/200m/300m in sequence). (100m by default)
- → **Button** – Lasers. Press the **Down Button**. [The laser function](#) (10m / 30m / 50m / off in sequence). (off by default)

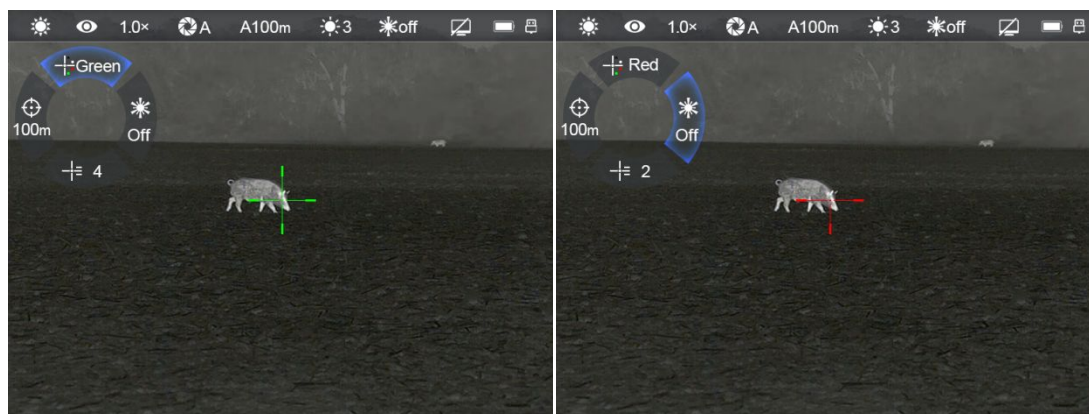



注意!



Holo系列全息热像仪配置一个激光指示器, 请注意以下几点:

- 请勿用眼睛直视激光;
- 请勿将激光对准人;
- 请勿用光学设备直视激光指示灯;
- 请勿自行拆卸、修改或修理热像仪;
- 激光可能对您的健康有害。



警告!



Holo系列全息热像仪配置一个符合3R类激光标准的激光指示灯。

激光辐射

避免眼睛受到直接照射

3R类激光产品

此激光波长为650 nm; 能量 < 3mW.

7.5 Advanced Menu

- On the home screen, press and hold the **M button** to enter the advanced menu.
- Press the **↑** or **↓ button** to switch the menu function options;
- The function options of the main menu are cyclical: When the cursor **>** reaches the last menu option on the first page, it will start from the first menu option on the second page; When the cursor **>** stays at the first option on the first page, you can press the **↑ button** to jump directly to the last menu option on the second page;
- Press the **M button** to modify the parameters of the current option or go to the next level of the menu;
- The position of the cursor **>** indicates the selected option, the icon of which turns from white into blue;
- The operations for secondary and tertiary menus are the same as above;
- Under all menu interfaces, you can press and hold the **M button** to save changes and return to the home screen, and press the **Power button**  to return to the upper menu without saving changes;

- During the continuous operation of the thermal imager, when exiting from the main menu, the cursor > remains at the position before exiting. When you restart the thermal imager and go to the main menu for the first time, the cursor stays at the first menu option.

Main Menu Features and Descriptions

👁️ Ultra-Clear -- turn on/off Ultra-Clear

- On the home screen, press and hold the **M** button to enter the advanced menu screen;
- Press the **Up** or **Down** button to select the "Ultra-Clear";
- Press the **M** button to turn on or off the Ultra-Clear;
- In the Ultra-Clear mode, the thermal imager

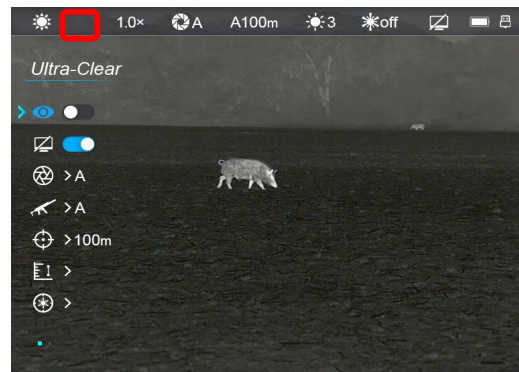

can display more details in severe weather conditions such as heavy fog, rain and snow. When it is activated, the icon in the status bar will prompt.

📄 Standby -- enable/disable the automatic standby function

- On the home screen, press and hold the **M** button to enter the advanced menu screen;
- Press the **Up** or **Down** button to select the "Standby Settings" option;
- Press the **M** button to enable or disable the Standby function;
- After enabling, the icon in the status bar will

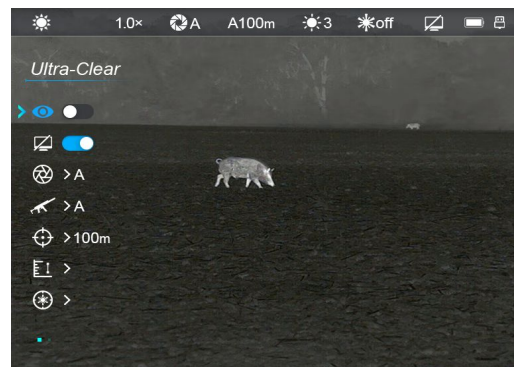

prompt, and in case of no button operation within 15 minutes, the device will automatically enter the Standby state.

🌀 Calibration ----- select different calibration modes

- On the home screen, press and hold the **M** button to enter the advanced menu screen;
- Press the **Up** or **Down** button to select the



Image Calibration option;

- Press the **M** button to enter the submenu of the Image Calibration;
- Press the **Up** or **Down** button to select calibration types (Automatic/Manual/Background);

When Manual is selected, press the power button on the always-on interface to finish the image calibration;

When Background is selected, make sure that the front end of the lens is against the black uniform surface, and press the Power button in the always-on interface to correct the image;

- Press the **M** button to confirm selection and save and return to the previous level.



Rifles Selection ----- Select different zeroing profile

- On the home screen, press and hold the **M** button to enter the advanced menu screen;
- Press the **Up** or **Down** button to select the "Gun Type" option;
- Press the **M** button to enter gun type submenu;
- Press the **Up** or **Down** button to select zeroing profile A/B/C;
- Press the **M** button to confirm selection and save and return to the previous level.

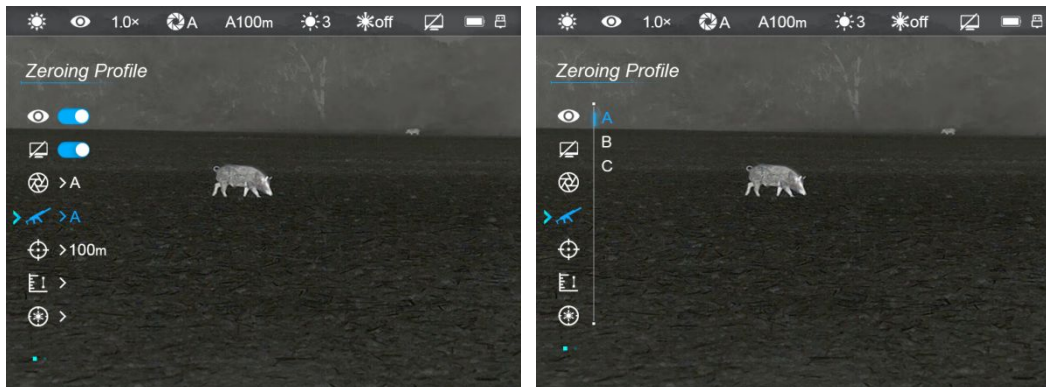

Zeroing

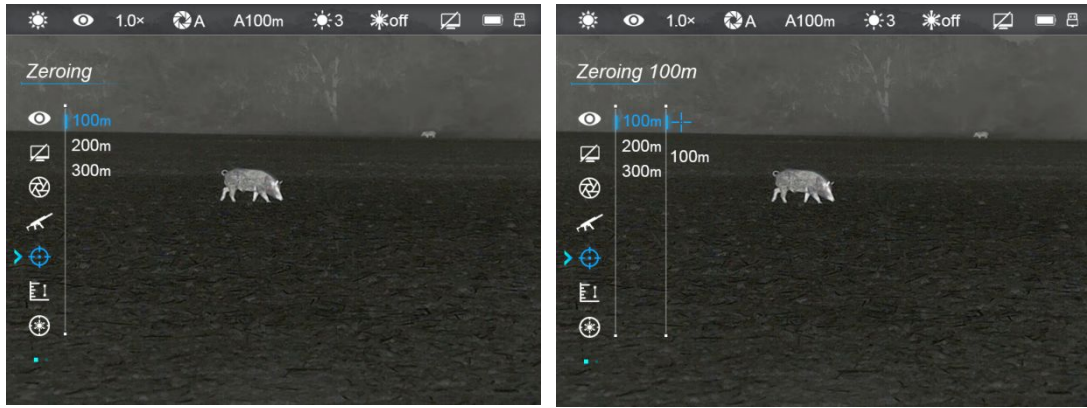

- On the home screen, press and hold the **M button** to enter the advanced menu screen;
- Press the **Up** or **Down button** to select the "Zeroing" option;
- Select the zeroing distance. Three groups of zeroing data can be set;
- Select one of them, and press the M button to enter the lower-level options, Calibration and Distance Setting. After setting the distance, enter the zeroing interface;
- Aim the reticle center of the device at the bull's eye and shoot, and then observe the position of the actual point of impact;
- Keep the device still, press the **M button** to freeze the screen, and at the same time, a freeze mark appears on the screen;
- Press the Up, Down, Left or Right button to adjust the X-axis and Y-axis to the position of the actual point of impact respectively, and press and hold the **M button** to hold and return to the Main Menu.



Target Range

This function can be used to calibrate the position in the rangefinding box when the value displayed in the box is not consistent with the actual distance to the target.

- On the home screen, press and hold the **M button** to enter the advanced menu screen;
- Press the **Up** or **Down button** to select the Rangefinding Calibration option;
- Press the M button to enter the Laser Calibration page. The X-axis and Y-axis directions are displayed. The center cursor returns to the center of the screen. The default cursor returns to the factory setting.
- When selecting the X or Y axis, press the **Up, Down, Left, and/or Right buttons** to move the laser to the correct position. Press the M button to exit the X or Y axis;
- Press and hold the **M button** to save the operations and return to the home screen;



Remarks: The indication icon will be valid only when the rangefinding module is connected;

Laser Calibration

If the actual target location differs from the location marked by the laser cursor, you can use this function to calibrate the laser cursor.

- On the home screen, press and hold the **M button** to enter the advanced menu screen;
- Press the **Up** or **Down button** to select the Laser Calibration option;
- Press the **M button** to enter the Laser Calibration screen;
- Press the **Up** and **Down button** to select the laser distance value, 10m / 30m / 50m;
- Press the **M button** to enter Laser Calibration, the X-axis direction and the Y-axis direction are displayed. Press or press and hold the Up or Down button to fine-tune or quickly calibrate the laser cursor to the correct position in the Y-axis direction. Press or press and hold the Left or Right button to fine-tune or quickly calibrate the laser cursor to the correct position in the X-axis direction;
- Press and hold the **M button** to save the calibration parameters and return to the home screen.



+ Pixels Defect Correction--Correction of image defective pixels

When using the thermal imager, you may see defective pixels, such as visible light spots or dark spots with stable brightness. To address this problem, use the Pixels Defect Correction function to remove the defective pixels.

- On the home screen, press and hold the **M button** to enter the advanced menu screen;
- Press the **Up** or **Down button** to select the Pixel Defect Correction option;
- Press the **M button** to enter the correction screen, and display the X-axis, Y-axis, and the number of defective pixels at the same time;
- Press the Up, Down, Left, or Right button to adjust to the position where pixel defect correction is required, and press the **M button** to add/delete the defective pixel;
- Press and hold the **M button** to display the prompt box of whether to save defective pixel. After confirming the saving, it will automatically return to the previous level of the menu;
- Press the **Power button** to not save this pixel defect correction and return to the main menu.

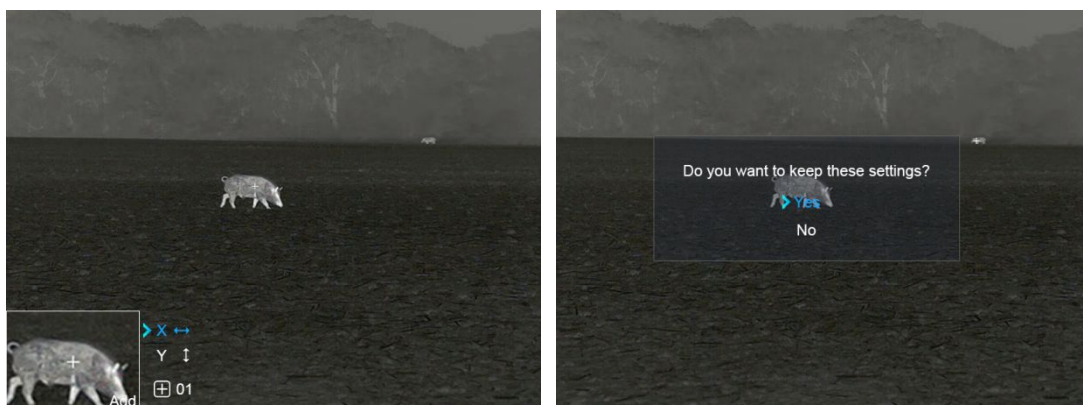



Setting

Set the date, time, language, status auto-hiding, factory reset, and device information query.



Status Bar Auto Hiding ----- the display or hiding of the status in the Status Bar

- Press the **Up** or **Down** button to select Status Auto Hiding option;
- Press the **Up** or **Down** button to enable or disable this function;
- Press the **M** button to confirm selection and save and return to the previous level.

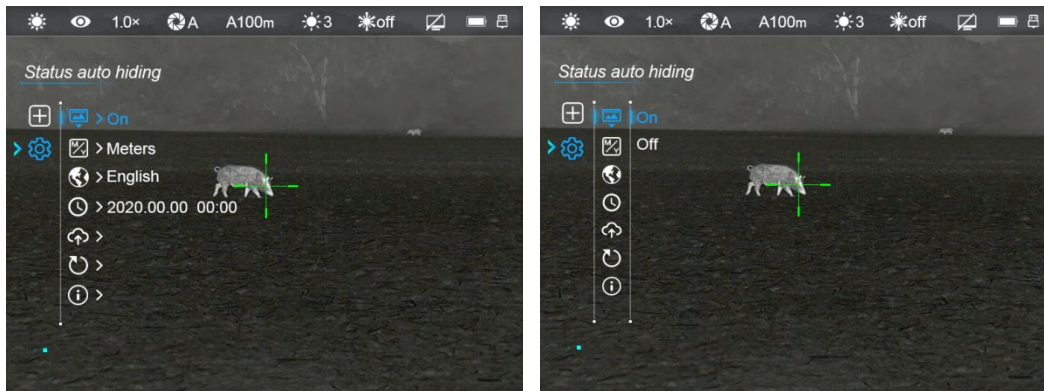

Units of Measure ----- Convert meter/yards

- On the home screen, press and hold the **M** button to enter the advanced menu screen;
- Press the **Up** or **Down** button to select the Unit Conversion option;
- Press the **M** button to enter the Units of Measure submenu. HOLO series supports Meter and Yards;
- Press the **M** button to confirm selection and return to the previous level.

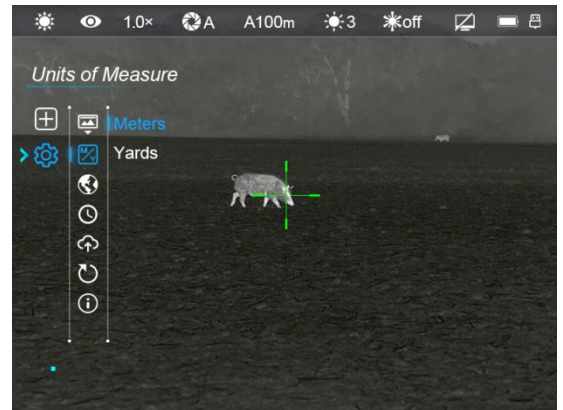

Language -- Select system language

- On the home screen, press and hold the **M** button to enter the advanced menu screen;
- Press the **Up** or **Down** button to select the



Language option;

- Press the **M button** to enter Language submenu;
- Press the **Up** or **Down button** to switch between the English and Russian;
- Press the **M button** to confirm selection and save and return to the previous level.



Date and Time

- On the home screen, press and hold the **M button** to enter the advanced menu screen for settings;
- Press the **Up** or **Down button** to select the Date and Time option;
- Press the **M button** to display upper and lower blue triangle, indicating selected;
- Press the Up or Down button to select the appropriate time, and press the **M button** to switch from left to right;
- After the setting is completed, press and hold the **M button** to save and exit the date reset function and return to the previous menu.

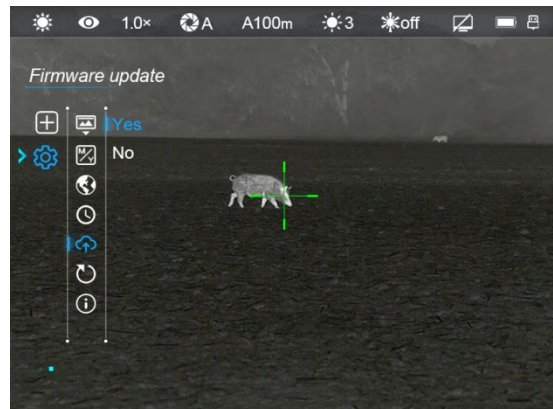

Firmware Update

When new firmware needs to be updated, it can be obtained from the after-sales service and placed in the root directory of the built-in storage. The firmware update can be performed according to the following operations.

- On the home screen, press and hold the **M button** to enter the advanced menu screen for settings;
- Press the **Up** or **Down button** to select the Firmware Update option;
- Press the **Up** or **Down button** to select Yes/No;
- Select Yes and press the **M button** to update, and select No and press the M button to return to the previous level.



Factory Reset -- Restore to the default settings at factory

- On the home screen, press and hold the **M button** to enter the advanced menu screen;
- Press the **Up** or **Down button** to select Factory Reset option;
- Press the **M button** to enter the submenu of this function;
- Press the **Up** or **Down button** to select Yes or No, and press the **M button** to confirm the selection;
- If select "Yes", the device will automatically restart and return to the default state; if select "No", cancel and return to the previous menu;

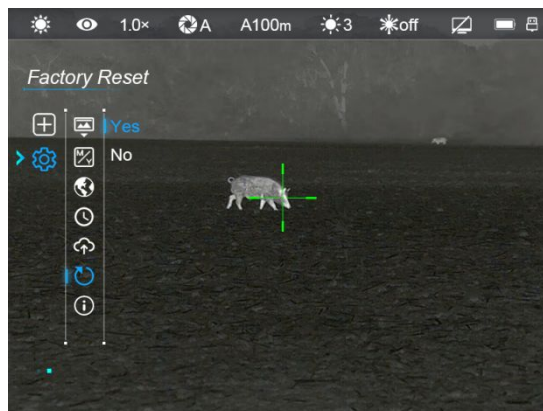

Info -- Query relevant information of device

- On the home screen, press and hold the **M button** to enter the advanced menu screen;
- Press the **Up** or **Down button** to select the Info option;
- Press **M button** to query relevant information of the device, including product model, GUI version number, software and hardware version number, and PN\SN code;
- Press the **M button** or the **Power button** to exit to return to the previous menu.

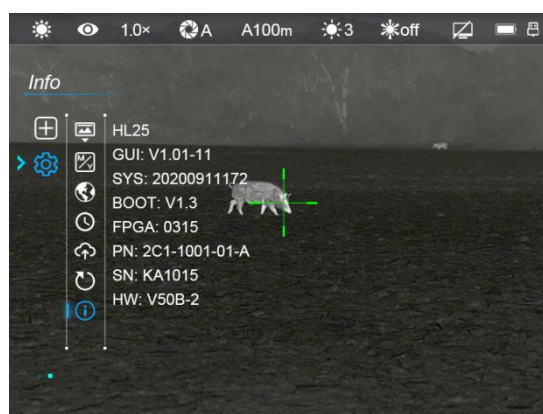

八、Fixture Installation

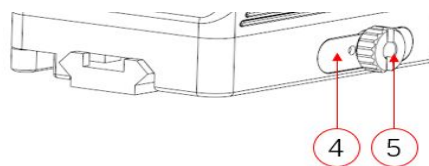
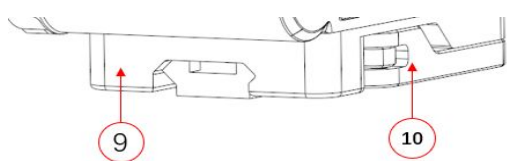

The bottom of HOLO series is equipped with a quick-release fixture, which, with simple and convenient operation, can be quickly installed on the picatinny rail for fixing. The specific method

is as follows:

- (1) First adjust the clamping pressure plate to a proper position through the nut (5);
- (2) Then put the HOLO device fixture (9) in a proper position of the picatinny rail, and pull back the wrench (10) to clamp the rail.

IX. Product Maintenance

The maintenance should be carried out at least twice a year and includes the following steps:

- Wipe the surface of metal and plastic parts to clear off dust and dirt by using a cotton cloth. Silicone grease may be used for the cleaning process.
- Clean the electric contact and battery slots on the device using a non-greasy organic solvent.
- Check the glass surface of the screen and lens. If necessary, clear off the dust and foreign matters on the lens (it is perfect to use a non-contact method). Use a specialized wiping tool and solvent to clean the optical surfaces.

X. Troubleshooting

The following table lists all problems that are likely to occur during device operation. Inspection and repair should be conducted according to the suggestions in the table. If faults not included in this table occur or you cannot fix the fault, return the device to the vendor for troubleshooting.

Fault	Possible Causes	Solution
The thermal imager cannot start.	The battery is out of charge.	Replace battery
The device cannot be powered by using an external power supply.	The USB cable is damaged.	Replace the USB cable.
	The external power supply is insufficient.	If necessary, check the external power supply.
Images are unclear, vertical lines are present, or the background is not even.	Calibration is required.	Calibrate the images as per the user manual.
The image is too dark.	The screen is not bright enough.	Adjust the display brightness
The icons are clear but the image is blurry.	The lens is not focused.	Rotate the lens focus knob to adjust the focus.
	The inner or outer optical surface of the lens is dusted or iced.	Wipe the outer optical surface by using a soft cotton cloth or leave the device to dry in a warm and dry environment for more than 4 hours.

The observed target disappears.	Glass and other crystalline objects may cover the field of view.	Find the glass and other crystalline objects from the field of view and move them out of the field of view.
The image quality is poor or the detection range shortens.	These problems are likely to occur when you use the device in harsh weather (such as snow, rain, and fog).	
When the device is used at a low temperature, the imaging quality is poorer than that at a normal temperature.	<p>At temperatures above 0°C, the temperature rise varies with the observed objects (environment and background) due to different heat conductivity coefficients. As a result, high-temperature contrast occurs and the image quality is better.</p> <p>At low temperatures, the observed targets (background) usually cool down to a similar temperature because of reduced temperature contrast. Therefore, the image quality (details in particular) is poor, which is a characteristic of thermal imaging devices.</p>	