

INSTRUCTION MANUAL

PORTABLE AIR CONDITIONER (HEAT PUMP TYPE)

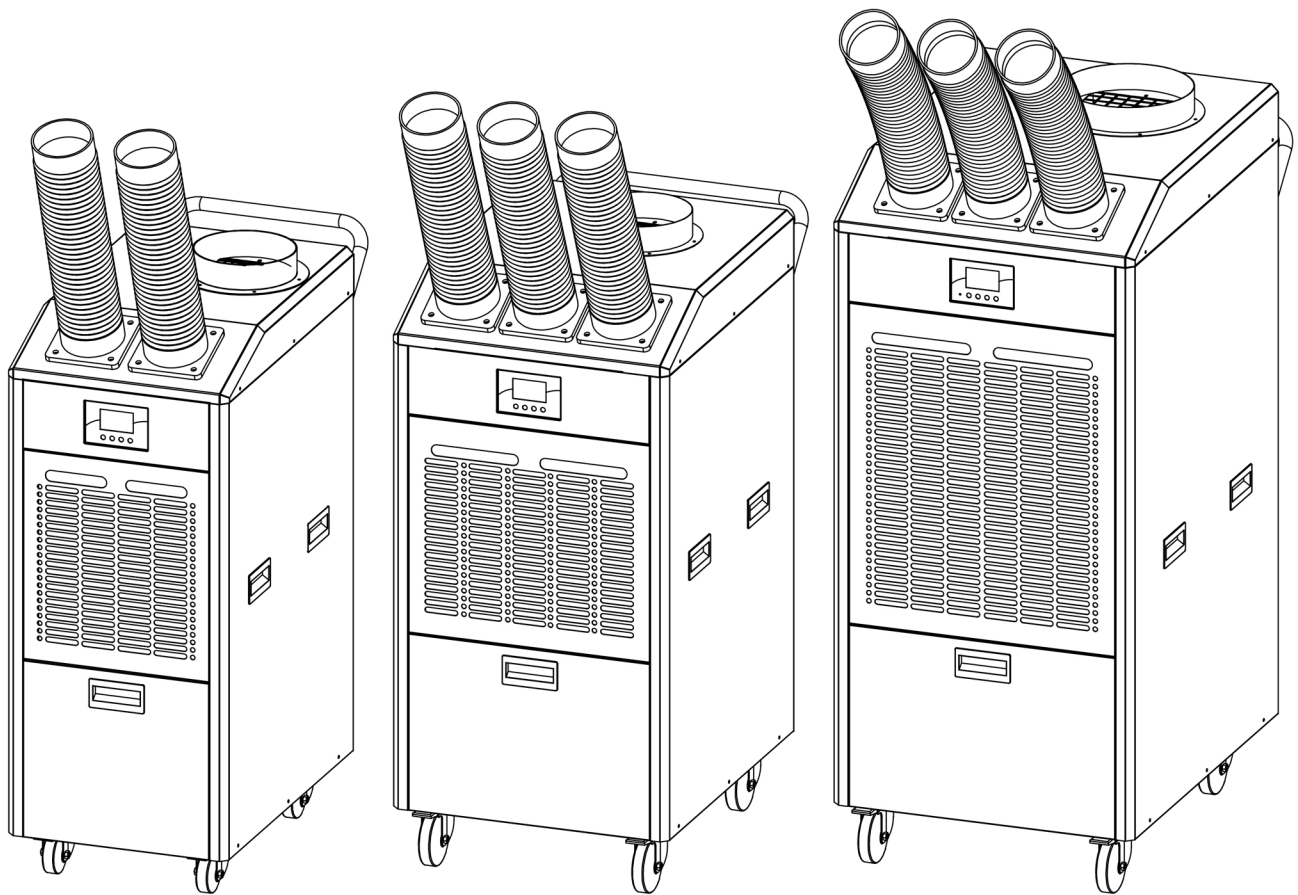

CAZAC16HP (AC120V/60Hz/1P)

CAZAC24HP (AC220V/60Hz/1P)

CAZAC36HP (AC220V/60Hz/1P)

INDEX

1 For your safety	2
2 Product specifications	5
3 Parts	5
4 Setup	9
①. Placing the unit	9
②. Attaching the cool air duct	9
③. Connecting to a power source	10
④. Trial operation	11
5 How to use	11
①. Adjusting the direction of airflow	11
②. The drain tank	11
6 Safety devices	12
7 Maintenance and storage	12
①. Cleaning the filter	12
②. External maintenance	12
③. Before storing the unit	12
8 Safety inspections	13
9 Troubleshooting	14
10 After service	15

Please read this manual to the end before commencing operation. Please also store this instruction manual in a place where it can be used by anyone who needs it at all times.

Thank you for purchasing this product.

Δ Note:

Do not use the unit in places with gases or vapor containing hydrochloric acid, sulphuric acid, or any other corrosive substances.

1 For your safety!

Please do not operate the unit before carefully reading and understanding the content of this section. The items treated in this section are to ensure safe use of the unit and to prevent harm or injury to you and others. Further, to clarify the severity of the harm and injuries that can result from incorrect use, the items in this section are divided into two categories; Warnings and Caution. However, since the actions explained under caution also sometimes can cause severe harm, please follow all instructions in this section carefully regardless of category.

 **Warning: Incorrect use can cause death or severe injury.**

● General caution

 Caution	
<p>Do not use the unit in any other way than is described in this manual.</p> <p>**Incorrect use can cause electric shock, short circuit, water leakage and other accidents.</p>	<p>Take care for use on ships or in vehicles.</p> <p>**Use on ships or in vehicles can result in water leakage and a short circuit.</p>

● Carrying / Moving the unit

 Caution	
<p>When carrying or moving the unit in any way, please keep it balanced and adapt your movement to the shape and weight of the unit at all time.</p> <p>**If the unit is dropped, there is a risk of injury and other accidents.</p>	<p>When packing the unit into and out of a vehicle, be sure to use two or more people to ensure safe operation.</p> <p>**If the unit is dropped, there is risk of physical injury and damage to the unit.</p>

● **Testing and operating the unit**

 Warning	
<p>Do not put wet hands on the plug, the switch or the electric wires. **This can cause electric shock and injury.</p>	<p>Do not expose to water or oil. **Water or oil can cause a short circuit, electric shock and other accidents.</p>
<p>Earth the unit securely, and use an earth leakage breaker (bought separately) at all times. **If the unit is broken or has a short circuit, there is risk of electric shock.</p>	<p>Use a 15 A rated electrical outlet. Do not plug in any other electrical appliance in the same outlet. **If other appliances are connected in the same outlet at the same time, the outlet can overheat and catch fire.</p>

 Warning	
<p>Please do not use the unit close to kerosene, gasoline, thinner, ether, paints or other flammable or explosive objects. **This can result in fire or explosion.</p>	<p>Do not use the unit close to dust, gas or steam containing aluminum, magnesium, titanium or other flammable substances. **This can result in fire or explosion.</p>

 Caution	
<p>If the unit is not working properly, pull the plug immediately and turn it in for service or repair. **There is risk of electric shock or fire caused by a short circuit.</p>	<p>Do not expose your body to the cold air from the unit for an extended period of time. **Prolonged exposure can harm your health. Use the swivel function, or direct the duct so it does not point directly at you.</p>
<p>Do not use the unit if vibrating or shaking or, on slanting surfaces. **The unit can unexpectedly move or fall, causing accidents and injuries. **Place the unit on a stable level surface.</p>	<p>Do not use the unit in places where it is exposed to water. **Contact with water can damage the insulation and cause electric shock, short circuit, fire and other accident and injuries.</p>
<p>Do not use in places with electrically conductive dust from Iron, carbon, casting, aluminum etc. **Electric shock or fire caused by a short circuit can occur.</p>	<p>If you use the unit in a very dusty environment, make sure to clean the interior of the unit regularly. **Electric shock or fire caused by a short circuit can occur.</p>
<p>Keep away from fire. **The unit can become deformed, causing short circuit and possibly fire.</p>	<p>Do not put hands or fingers into the exhaust hole. **There is risk of injury.</p>
<p>Do not use the unit if the cord or plug is damaged, or if the plug is loose in the socket. **Electric shock or fire caused by a short circuit can occur.</p>	<p>If you use an extension cord, make sure to use one that meets the specified requirements. **There is risk of the cord overheating and catching fire.</p>

<p>Do not let the plug get dirty or get exposed to metal objects while plugged. **There is risk of electric shock, short circuit and fire.</p>	<p>Do not put heavy objects onto the electric cord. **If the cord gets damaged, there is risk of electric shock and fire.</p>
<p>Do not use the extension cord while it is coiled or bundled together. **There is risk of the cord overheating and catching fire. **Make sure that the extension cord is extended before use.</p>	<p>Do not use the unit in other than the stated operation conditions. **Since there is risk of electric shock, short circuit and malfunction, please use the unit within the suitable range.</p>
<p>Do not damage, process, nor bend, pull, twist or bundle the cord excessively. **If the cord gets damaged, there is risk of electric shock or fire.</p>	<p>Use where electrical supply is within the allowed range: 99V - 121V, 60 HZ. **There is risk of electric shock and short circuit.</p>
<p>Remove the plug from the electric outlet when the unit is not in use. **There is risk of burning and other injuries, electric shock, fire caused by short circuit etc.</p>	<p>Do not use the unit in places with a lot of cutting oil or mineral oil. **They can cause the resin made parts of the unit to deteriorate, which can result in accidents and injuries.</p>
<p>When you unplug the plug, be sure not to pull it by the cord, but to pull it out holding the plug directly. **There is risk of electric shock, short circuit and fire.</p>	<p>Lock the caster wheels with the caster stoppers before starting to operate the unit. **The unit can start to move unexpectedly and cause accidents and injuries.</p>
<p>Do not use the unit in a place with dust that is harmful to the human body. **If harmful dust sticks to the unit, there is risk of harmful dust dispersal when the unit is in operation.</p>	

 **Caution**

<p>Make sure that the unit is unplugged when in storage. **There is risk of injury and electric shock.</p>

● **Maintenance**

 **Caution**

<p>Disassemble, repair and reassemble is not to be attempted by anyone other than an authorized repairman/ technician. **Inadequate or poor handling can result in fire, malfunction and injuries.</p>	<p>All maintenance must be conducted while the unit is unplugged. **There is risk of electric shock and physical injuries.</p>
---	---



2 Product specifications

Model number	CAZAC16 HP	CAZAC24HP	CAZAC36 HP
Voltage	AC120/60Hz/1P	AC220V/60Hz/1P	AC220V/60Hz/1P
Cooling capacity	16000BTU/H	25000BTU/H	36000BTU/H
Heating Capacity	18000BTU/H	27000BTU/H	40000BTU/H
Air volume	700m3/h	900m3/h	1200m3/h
Rated power	1800W	3300W	4500W
Rated running amps	15.0A	15.0A	20.4A
Noise	50-55dB	55-60dB	60-65dB
Dimensions	440*670*1100mm	550*670*1160mm	600*770*1380mm
Usable floor area	50-80 m ²	80-180 m ²	200-300 m ²
Outlet pipe	2pcs	3pcs	3pcs
Weight	85kg	100kg	130kg
Working temperature	0°F -113°F		
Refrigerant	R410A		
Remarks	Above refrigerating capacity, power consumption, current operation on the basis of working temperature 95°F test values.		

3 Parts

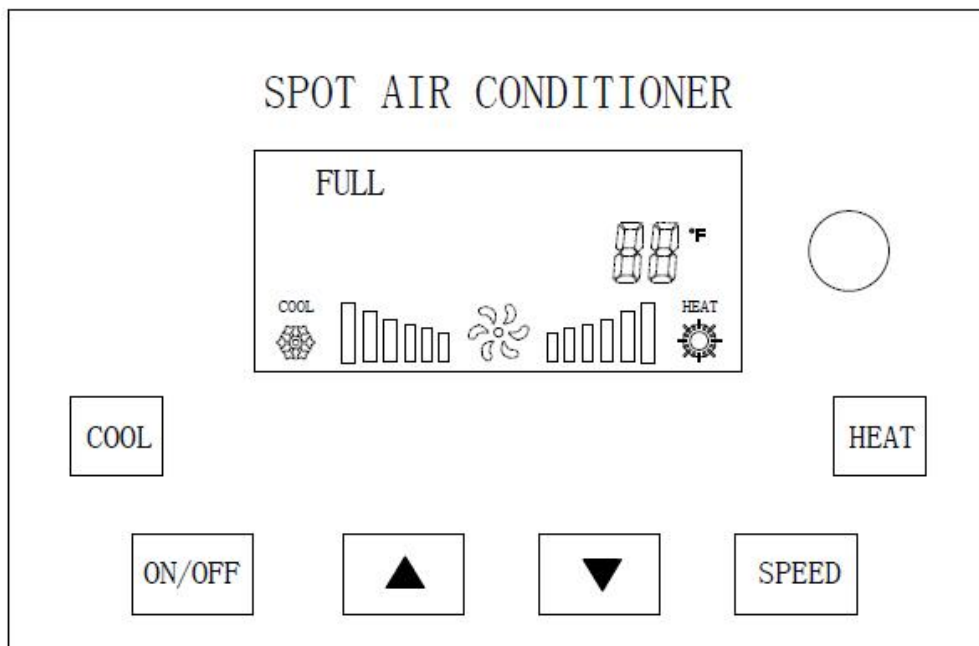
The Control Panel

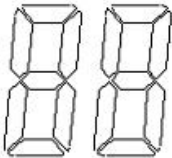

Display Icon	Display shows
Cooling Icon 	<ol style="list-style-type: none"> 1. It means the machine is working under cooling situation. This icon will be show when the compressor stops and it will flash. 2. When turned off, it will not show the symbol.
Heating Icon 	<ol style="list-style-type: none"> 1.It means the machine is working under heating situation. This icon will be shown. When compressor stops it will flash. Press MODE button shortly for thrice, it will come to cooling and heating change mode. 2.When turned off, it will not show the symbol.
Wind Speed Icon 	<ol style="list-style-type: none"> 1. Switch On: High fan displays fast, low fan displays slow. 2. Switch Off: Fixed display.
Digital Icon 	<ol style="list-style-type: none"> 1. Normal situation: Displays room current temperature. 2. Setting temperature: Display flashing setting temperature value. 3. Water full: Display “FU” 4. Failure: Display failure codes every 30 second rotation.
Water Filled Icon FULL	<ol style="list-style-type: none"> 1. Normal situation: Without this icon. 2. Water full situation: Display Icon is blinks. 3. Display “water filled icon”, the machine stops working, after emptying the water tank, the machine to run automatically.

Operation panel and instructions:

Button	Instruction of the buttons
Single button instruction:	
ON/OFF	Conversion between power on and power off after you press each time;
▲	Adjust the different value in different condition: <ol style="list-style-type: none"> 1. Increase temperature setting value. (Range 50°F -99°F) ; 2. Increase wind speed.
▼	Adjust the different value in different condition: <ol style="list-style-type: none"> 1. Decrease temperature setting value (Range 50°F -99°F) ; 2. Decrease wind speed.
SPEED	Press this button shortly to adjust the fan motor speed. Press this button 6-8s under power on station, then enter into timing on/off mode.
2. Combined button instruction	
	Display current ambient temperature(Press these 2 buttons for 3 seconds at

▼+SPEED	same time)
▲+SPEED	Display coil temperature (Press these 2 buttons for 3 seconds at same time)
HEAT + SPEED	Transfer from °F to °C (Press these 3 buttons 5 seconds at same time)

Function Description:

1. Temperature control:

Please press ▲ and ▼ buttons to adjust temperature. When machine reach the set temperature, it will stop working automatically;

2. Protection function:

- (1) Compressor once stopped, it needs 3 minutes to re-start;
- (2) When water tank is full, compressor will stop working;

3. Additional function:

- (1) Power failure memory function: The setting temperature, fan speed and running time will be recovered after restoring power.
- (2) Self-diagnosis function

Fault code table:

Fault code	Fault reason	Related content
E1	Evaporator and condenser sensor fault	Need to replace the sensor
E2	Coil temperature sensor fault	Checking sensor wiring connection. Replace new sensor.
E3	Room temperature sensor fault	Instruct working environment temperature is too high, can be restored.
E4	system fault	After 20 minutes, if the compressor is not detected temperature dropping, need to check the compressor and refrigerant gas.

Controller, terminal, temperature sensor:

1.Terminal instructions:

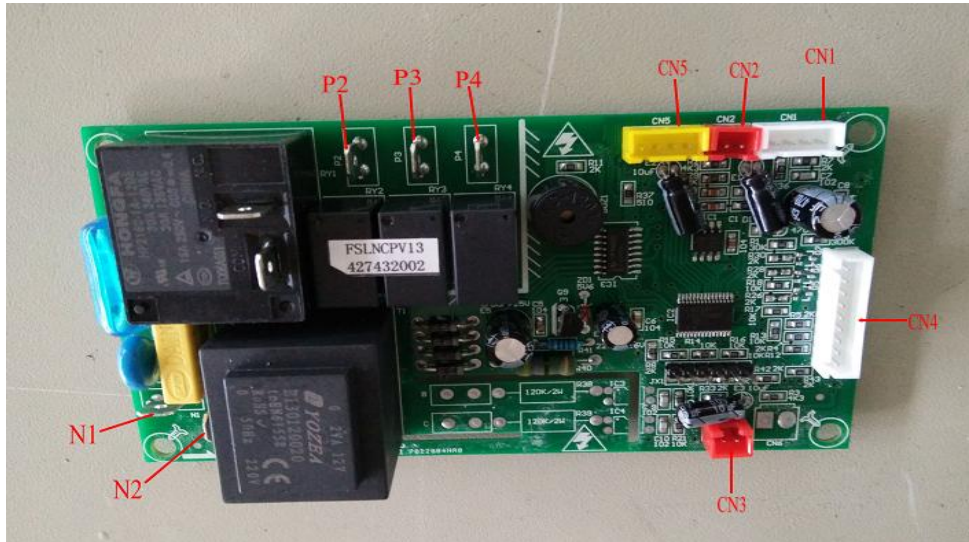

Marking	Specification Model	Introduction
N1,N2	T6.3 Single insert	The AC power zero input/output end.
Relay COM	T6.3 Single insert	The ac power fire line input
Relay N.O	T6.3 Single insert	The compressor output interface
P4	T6.3 Single insert	Four-way valve output interface
P3	T6.3 Single insert	High speed fan output interface
P2	T6.3 Single insert	Low speed fan output interface
CN1	B4B-XH White slot	The temperature sensor input interface
CN2	Red slot	Detection systems sensor input interface
CN3	Red slot	Defrost detection sensor input interface
CN4	B9B-XH White slot	From the mainboard to display panel interface.
CN5	Yellow slot	Water level sensor input interface

Electrical wiring diagram

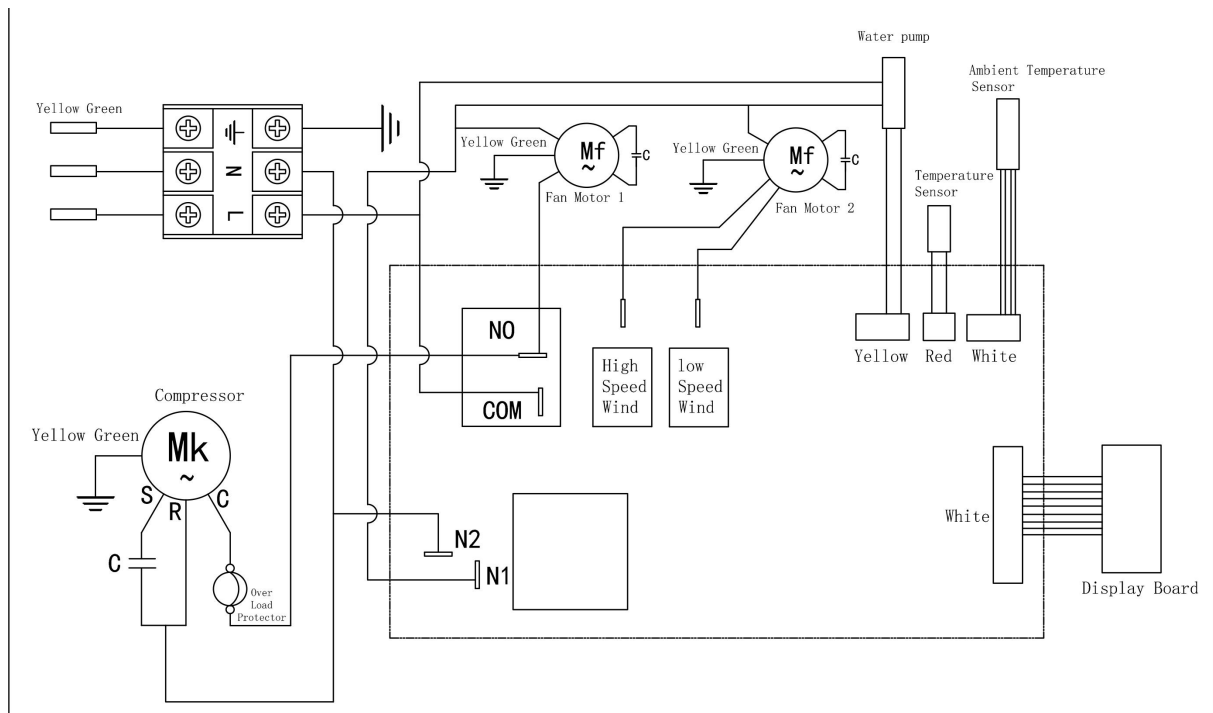

4 Setup

1. Placing the unit

Make sure that the unit is placed so that there is nothing blocking the front side filter, the cool air duct or the hot air

Important: To ensure safety, read section one “1 For your safety!” first.

exhaust duct.

There is only an air inlet on the front side, and the only air outlets are on the top, so the unit can be placed with the other sides directly against a wall, in a corner or in any other confined space.

Note: Do not use the unit in places containing hydrochloric acid, sulfuric acid or any other corroding gas or steam.

**** There is risk of gas leak or deterioration of performance.**

2. Attaching the cool air duct

(1) Attaching the duct elbow

I. Insert the duct elbow into the elbow holder, fitting the attachment notch to the black mark on the inside of the holder.

II. After you have inserted the duct elbow into the holder, fasten it so it does not come loose by turning it to either side.

(2) Attaching the cold air duct

- ① Insert the cold air duct into the duct elbow, fitting the attachment peg on the duct to the attachment notch in the elbow, then turn it to the right.
- ② Point the duct in the direction you want the air to blow in, fixing the duct elbow with your other hand.

Note: Make sure that the duct elbow is correctly inserted into the holder. If the duct elbow is not attached evenly, re-attach it correctly.

(3) Removing the duct elbow

- ① Remove the cool air duct from the elbow.
- ② Turn the elbow until the attachment notch is aligned with the insertion mark.
- ③ Remove the duct elbow by pulling it straight up from the holder.

● Adjusting the firmness of the cold air duct

If the cold air duct is too loose, it will just droop down, not maintaining the desired direction of the cool airflow. If this is the case, tighten the duct in the following manner.

- ① Grab both ends of the duct and stretch it until it is fully extended.
- ② Make the duct tighter by twisting the right end of the Duct one or two times, fixing the left end of the duct with your other hand. Now the duct should maintain any shape desired by the user.

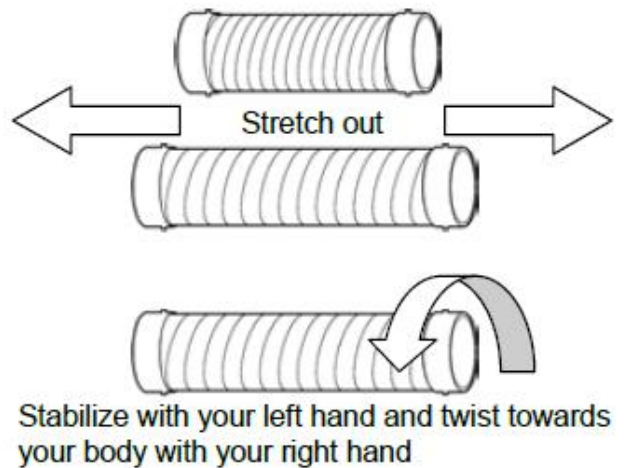

Note: ① If something is dropped into the exhaust air vent, do not use a stick or similar object to try to retrieve it. You may damage internal parts and cause malfunction.
 ② Do not block the exhaust air vent in any way. This will obstruct the function of the unit and cause malfunction.

2. Connecting to a power source

Note Do not connect any other electrical appliance to the same power source that the unit is connected to.

(1) Electrical wiring

Make sure that no other electrical appliance is connected do the same power source as the unit.

(2) The circuit breaker

Use a 15A 30mA ≤ 0.1 sec. circuit breaker.

(3) Connecting the unit to a power source. Insert the plug into the power source.

4. Trial operation

Turn on the power switch, the airflow adjustment switch and the swivel switch to make sure that everything works properly.

① The properties of all the switches are explained further in the next section “How to use”.

② If the unit does not work properly, please consult page 13

“Trouble shooting” for further guidance.

5 How to use

Important: To ensure safety, read section one “1 For your safety! “

1. Adjusting the direction of airflow

The cool air duct can be adjusted, so please operate the unit after having pointed it in the desired direction.

2. The drain tank

(1) The drain tank collects the condensed water

Part of the condensed water that appears in the upper cold part of the heat exchanger on the front of the unit vaporizes when it passes through the warm lower part on the way down to the drain tank. In certain environments almost all water will vaporize, leaving nothing for the drain tank. This does not mean that the unit is not working.

Note: ①The amount of condensed water that gathers in the drain

tank varies depending on the temperature and humidity of the environment where the unit is used, as well as how clean or dirty the heat exchanger is. The amount of condensed water increases during rainy seasons and other times with high humidity, so be extra attentive at these times.

② When the drain tank becomes full the water will start spilling out on the floor, so check the amount of water in the drain tank frequently and empty it before it gets full.

③ Since the condensed water in the drain tank will spill when the unit is moved, be sure to empty the tank first.

(2) Draining the condensed water with a hose

You can drain the condensed water directly to a drain or other desired place by attaching a hose onto the drain outlet. The inside diameter of the hose should be 16mm.

- ① Remove the drain tank.
- ② Attach the hose to the drain outlet, located on the upper left side of the drain tank, please fixed the hose with a cramp.
- ③ Place the other end of the hose in a drain or other suitable place.

6 Safety devices

The compressor overload relay

- ① The overload relay protects the compressor from over current's and overheating motor windings.
- ② The compressor overload relay is automatic. If the overload relay starts to work frequently (and the unit stop working), please take steps to eliminate the cause of the problem. If the cause is left unfixed, the unit can break down or malfunction.

Please consult "Trouble shooting" on page 13 for more information.

7 Maintenance and storage

Important: To ensure safety, read section one "1 For your safety!" first.

1. Cleaning the filter

- ① Remove the filter by pulling it straight up.
- ② Clean off the dust from the filter with a vacuum cleaner.
- ③ If the filter is dirty, it should be cleaned with water.
- ④ Reinstall the filter into the unit after it has dried completely.

2. External maintenance

Wipe the ducts and other external parts clean with a dry piece of cloth, or a cloth with diluted neutral detergent.

Note Be very careful if you use thinner, benzene, chemicals or polishing powder or similar substances when cleaning the unit. You can easily damage the coating or cause malfunction.

3. Before storing the unit

- ① Clean the filter and the exterior of the unit.
- ② Empty the drain tank and let it dry completely.
- ③ Turn on “Ventilation” for approximately one hour to let the internal parts dry completely.
- ④ Cover the unit with a suitable cover to prevent dust from gathering.
- ⑤ Store all the parts in a secure place so that nothing gets lost or damaged.
- ⑥ Clean the electric cord before storing it.

* Regarding cleaning of the heat exchanger, the sirocco fan and other internal parts, please consult with your local dealer. If you clean the internal parts before storage, the unit can be used immediately afterwards.

Note: Store the unit in a vertical standing position. Do not store it lying down.

** If the unit is stored lying down, the compressor or other parts can break down or malfunction.

8 Safety inspections

Important: To ensure safety, read section one “1 For your safety!” first.

To ensure safe operation, please perform the following inspections before use.

If any fault or malfunction is discovered, please take measures immediately.

Inspection	Measure
Is the electric cord damaged or deformed?	Change the cord after having consulted with an authorized electrician.
Is the plug deformed or broken?	Change the plug after having consulted with an authorized electrician.
Is the cord and the power source connected correctly?	If not, connect them correctly.
Are the ducts deformed or torn?	Change them for new ones.
Is the filter clogged with dust or dirt?	Clean the filter.
Is the filter installed correctly?	If not, install it correctly.
Is the filter torn or damaged?	Change it for a new one?
Are the fin of the heat exchanger broken?	Hand the unit in for inspection and repair at your local retailer.
Is the heat exchanger fin covered with dust or greasy dirt?	
Is the filter or cool air duct blocked?	Remove the obstructing object.
Is the drain tank installed correctly?	If not, Install it correctly.
Is the drain tank damaged?	Change it for a new drain tank.
Are the caster wheels worn out?	Change the caster wheels.
Are the caster stoppers working normally?	If not, change the caster wheels.
Are all the switches and buttons working properly?	If not, consult page 13 of this manual and follow the instructions. If the problem remains even after

	that, please consult with your local dealer regarding inspection and repair.
Is the unit emitting strange sounds or smells?	Please consult with your local dealer regarding inspection and repair.

9 Troubleshooting

Important: To ensure safety, read section one “1 For your safety!” first.

What's wrong?	What to check	Measure
I cannot turn on the unit	Is there power supply? (The power could be off because of blackout etc.)	Turn the power switch to “STOP” until the power is back on again. If the switch is turned to “COOL” when the power comes back on, the fuse might blow.
	Is the plug correctly connected in the outlet?	Insert the plug correctly into the outlet.
	Is the electric cord broken or damaged in any other way?	Fix the cord if possible, otherwise change it for a new one.
	Is the electric fuse blown or the breaker down?	Please consult with an electrician or your local retailer.
	Is the overload relay running?	The unit will restore itself automatically. Wait for the unit to be restored, turn the switch to “STOP”, wait 3 minutes and then restart the unit.
The fuse blew or the breaker is down	Is the capacity of the breaker sufficient?	Make sure that no other appliance is connected to the breaker or the branch circuit.
	Did you keep the air conditioner turned off for three minutes?	If you have turned off the unit, make sure to wait at least 3 minutes before turning on the “COOL”/“HEAT” again. (This does not apply to “AIR”, which can be turned on immediately.)
	Is the voltage too low?	Consult with your electric company.
The unit turns itself on and off frequently (The overload relay)	Is the voltage too low?	Consult with your electric company.
The air from the unit is not cool/heat	Is the power switch not set to “COOL”/“HEAT”?	Set the switch to “COOL”/“HEAT”.
	Is the filter or cold air duct blocked?	Remove the obstructing object.
	If the filter clogged with dust or dirt?	Clean the filter.
The cooling/heating effect is weak	Is the room temperature too high/too low? (Higher than 113 °F is too high/lower than 0 °F)	Improve the ventilation to lower the temperature of the room, or use the unit in a room that correspond to required conditions: 77 °F -113 °F (for cooling)/ above 0 °F (for heating).

Water is leaking from the unit	Is the drain tank damaged?	Repair it or change it for a new one.
	Is the drain pipe clogged?	Clean the drain pipe.
	Is the drain tank full?	Empty the drain tank.
	Is the drain tank placed correctly?	If not, place it in its correct position.

■ If the problems do not get resolved by the above suggested measures, please consult with your local dealer.

10 After service

Caution

Please use manufacturer's parts for maintenance and repair.

**If you use spare parts other than manufacturer's parts, there is risk that they will not fit properly and can cause malfunction or accidents.

● Repair

For questions regarding acquiring spare parts or regarding repair, please contact the store where you purchased the unit, after having prepared the product number, the manufacturer's serial number and the date of purchase.

For your safety

**If you intend to use the unit to preserve food products, animals and plants, precision machines, art objects etc., please check the specific requirements of those objects carefully before you commence. Inaccurate or inappropriate use can cause the quality of the objects to deteriorate.

**Sometimes it will be necessary to perform installation work and electric work to the unit. In these cases, contact your local dealer or an experienced professional. If the works are performed inadequately, there is risk of electric shock, fire or accidents.